



Pyroelectric Infrared Sensor Module

(Model: ZRD-09)

User's Manual

Version: 1.0

Valid from: 2016-06-20

Zhengzhou Winsen Electronics Technology Co., Ltd

Statement

This manual copyright belongs to Zhengzhou Winsen Electronics Technology Co., LTD. Without the written permission, any part of this manual shall not be copied, translated, stored in database or retrieval system, also can't spread through electronic, copying, record ways.

Thanks for purchasing our product. In order to let customers use it better and reduce the faults caused by misuse, please read the manual carefully and operate it correctly in accordance with the instructions. If users disobey the terms or remove, disassemble, change the components inside of the sensor, we shall not be responsible for the loss.

The specific such as color, appearance, sizes &etc, please in kind prevail.

We are devoting ourselves to products development and technical innovation, so we reserve the right to improve the products without notice. Please confirm it is the valid version before using this manual. At the same time, users' comments on optimized using way are welcome.

Please keep the manual properly, in order to get help if you have questions during the usage in the future.

Zhengzhou Winsen Electronics Technology CO., LTD.

ZRD-09 PIR Motion Sensor Module

ZRD-09 Pyroelectric infrared sensor module adopts high performance PIR sensor, Fresnel lens, Pyroelectric dedicated chip and High-performance voltage regulator circuit. It has the features, as low static power consumption, wide operating voltage, and high sensitivity. It has repeatable and non-repeatable trigger terminal to be selected, thus this module can be set according to the actual demand, convenient to use.

Features:

- Automatic Induction (when people enter into its sensing area, it gives an high-level output; when people leave the sensing area, it closes high-level output by automatic-delay, and gives an low-level output.)
- Photo-resistor control(optional, not set at factory): the module is reserved for position, where you can set the photo-resistor control. At daytime or high-light condition, it will not response. This photo-resistor control is an optional function, not installed at factory. Please contact us for photo-resistor if necessary.
- Two trigger modes: L, non-repeatable trigger; H, repeatable trigger. Default is H.
 - 1) Non-repeatable trigger: after high-level output, once the delay time is end, the output will convert from high-level to low-level.
 - 2) Repeatable trigger: after high-level output, on the delay period, if there is human activity in its sensing range, the output remain high-level, and will not convert from high-level to low-level until people leave and the delay period is over. (when the sensor module detects every human body activity, it extend a delay period automatically, and use the last activity time as the starting time of delay period.)
- Induction blocking time(default setting as 3-4 second): after every sensing output(from high-level to low-level output), a blocking time can be set. At this period, the sensor does not receive any sensor signal. By this function, it can realize interval working, to be applied to interval detection production. At the same time, this feature can inhibit all kinds of interference generated by the switching of load.
- High-level output: easy to interface with kinds of circuits;



Applications

Security products,
Human body induction toys,
Human body induction lamps, switches, and appliances
Industrial automatic controlling

Parameters

Table 1

Working Voltage	5~20V DC
Static Current	<65μA, @5V
Level Output	High Level, 3V; Low Level, 0V
Trigger Mode	Repeatable/Unrepeatable
Delay Time	3~300S(adjustable)
Blocking Time	Default as 4S
PCB Size	32×24×24mm (L×W×H)
Detection Angle	100°(Depend on the Lens)
Working Temperature	-10°C ~ +70°C
Fresnel Lens Size	Diameter 23mm(default)
Detection Distance	4~8m(adjustable)



Detection Range

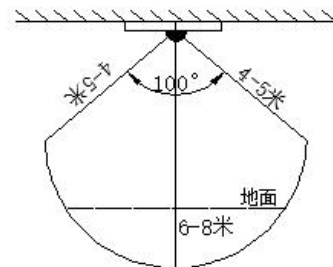
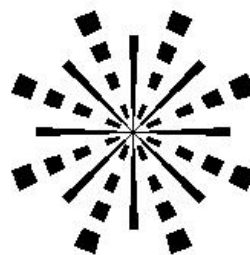
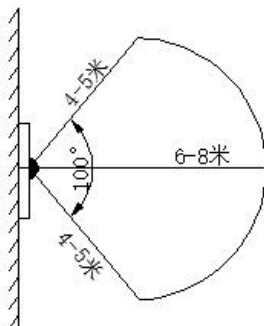

Dimension & Adjust

Distance to adjust

Time to adjust

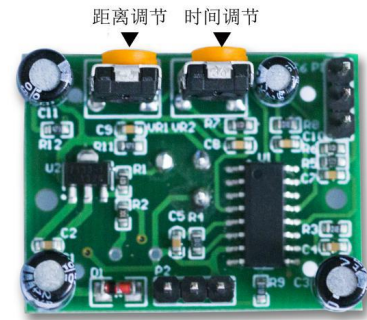
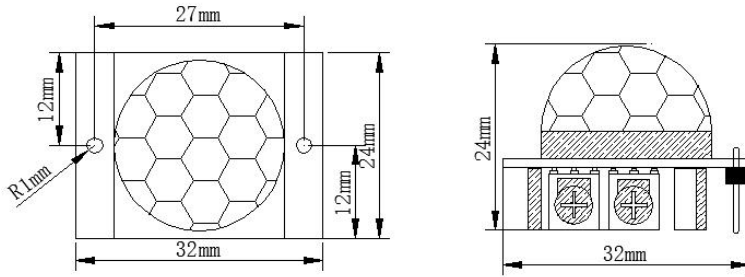

Application:

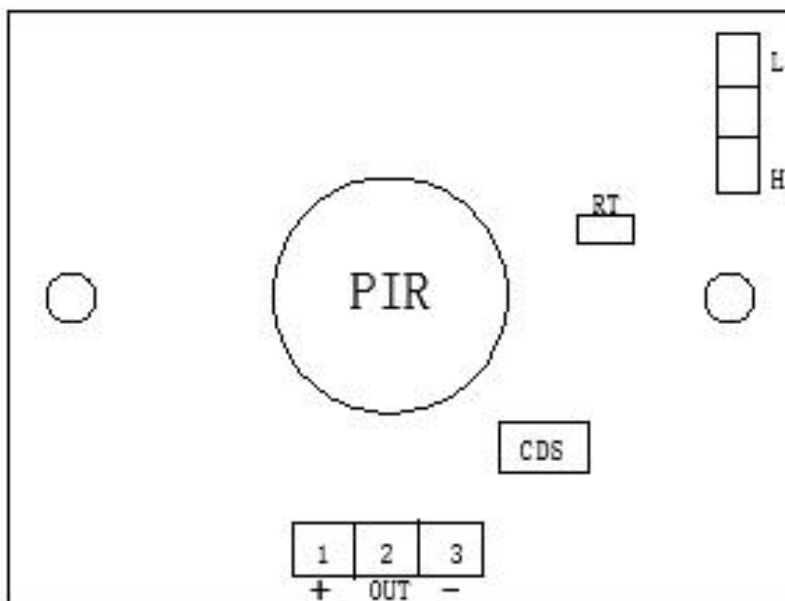

- 1. Positive electrode
- 2. Signal Output
- 3. Negative electrode
- 4. H- Repeatable trigger terminal
- L- NON-repeatable trigger terminal
- 5. CDS Photosensitive resistance
- 6. RT Temperature compensation

DC load circuit diagram

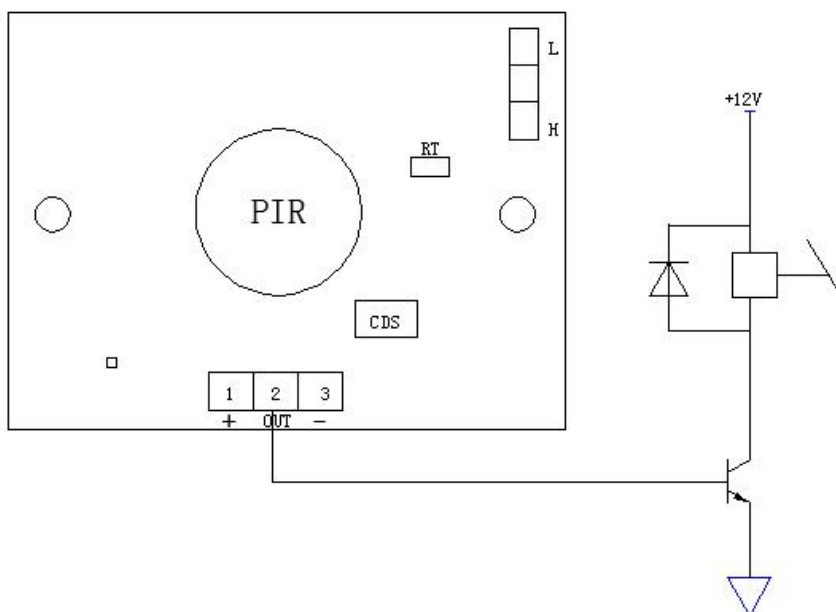

AC load circuit diagram

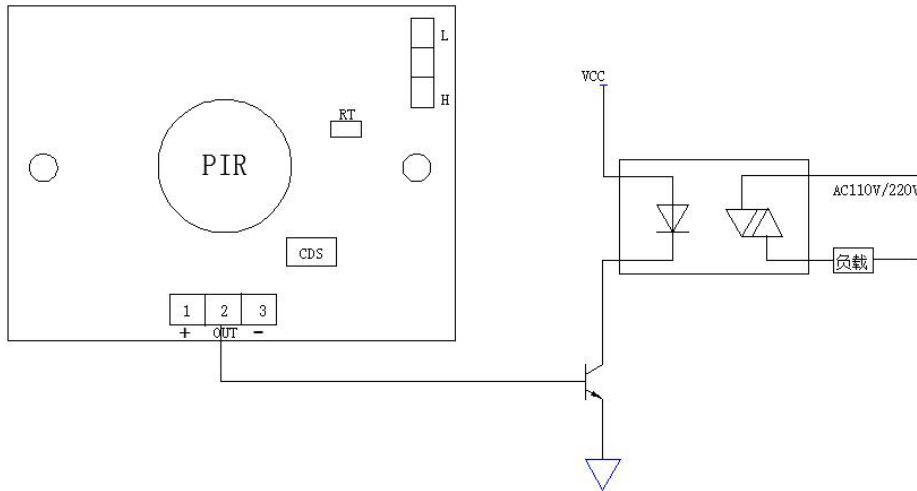

Cautions

1. Please keep the module warming up for one minute when using it for the first time
2. Please avoid lights or other interference source close to the lens, as well as the wind flow in the environment, so as not to cause false action.
3. This sensor module is using dual sensing elements. Please keep the direction of the dual sensing element in parallel with the human activity direction, to make sure that human activity is detected by the dual-element one after another.

Note: To keep continual product development, we reserve the right to change design features without prior notice.

Zhengzhou Winsen Electronics Technology Co., Ltd

Add: No.299, Jinsuo Road, National Hi-Tech Zone, Zhengzhou 450001 China

Tel: +86-371-67169097/67169670

Fax: +86-371-60932988

E-mail: sales@winsensor.com

Website: www.winsen-sensor.com