

# XD6702 Series

ETR03103-002

## 36V input, 300mA low supply current, high speed voltage regulators

☆AEC-Q100 Grade2

### ■ GENERAL DESCRIPTION

The XD6702 series are CMOS high-speed voltage regulator ICs with a 36V input and low supply current. Internal circuitry includes a reference voltage supply, error amplifier, driver transistor, over-current protection circuit, Thermal shutdown circuit, soft start circuit, and phase compensation circuit.

The output voltage is fixed internally by laser trimming, and product selections from 1.8V to 18.0V are available. The over-current protection function and Thermal shutdown protection are built-in, and when the output current reaches the current limit or the junction temperature reaches the temperature limit, the corresponding function activates.

The soft start circuit limits the rush current that flows from  $V_{IN}$  to  $V_{OUT}$  when the IC starts, enabling a stable startup sequence. The IC is put in the standby state by inputting L level into the CE pin, and the supply current is reduced to 0.1  $\mu$ A. A low-ESR capacitor such as a ceramic capacitor can also be used for  $C_L$ .

### ■ APPLICATIONS

- Automotive Infotainment
- Automotive accessories
  - Drive recorder
  - Car-mounted camera
  - ETC
- Constant-voltage power supply  
for electrical application for vehicle interior

### ■ FEATURES

Input Voltage Range	: 4.5V ~ 36.0V
Peak Voltage	: 46.0V (Transient $\leq$ 400ms)
Output Current	: 300mA
Output Voltage Range	: 1.8V ~ 18.0V
	$V_{OUT} < 6.0V$ , 0.1V step settings
	$V_{OUT} \geq 6.0V$ , 0.5V step settings
Temperature Characteristics	: $\pm 50$ ppm/ $^{\circ}C$ (TYP.)
Supply Current	: 40 $\mu$ A
Dropout Voltage	: 350mV @ $I_{OUT} = 100mA, V_{OUT} = 5.0V$
Ripple Rejection Ratio	: 65dB @ 1kHz
Standby Current	: 0.1 $\mu$ A
Protection Function	: Current limit Thermal shutdown
Addition Function	: Soft start CE function (Active High)
Output Capacitor	: Ceramic capacitor (2.2 $\mu$ F)
Package	: SOT-89-5
Environmentally Friendly	: EU RoHS Compliant, Pb Free

### ■ TYPICAL APPLICATION CIRCUIT

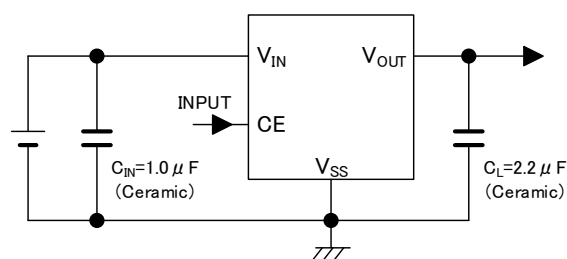

### ■ TYPICAL PERFORMANCE CHARACTERISTICS

Load Transient Response

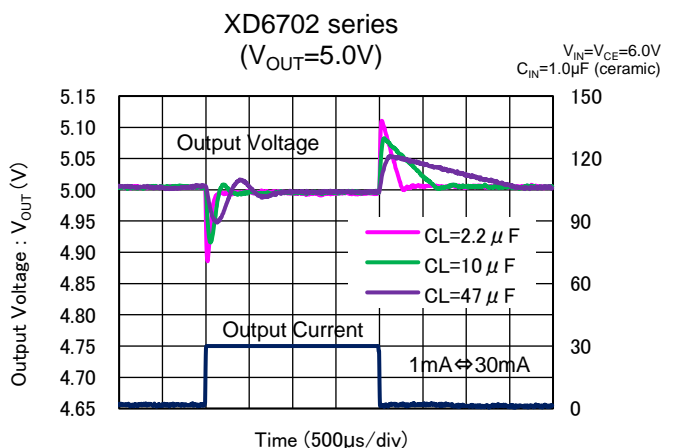

## ■ BLOCK DIAGRAM

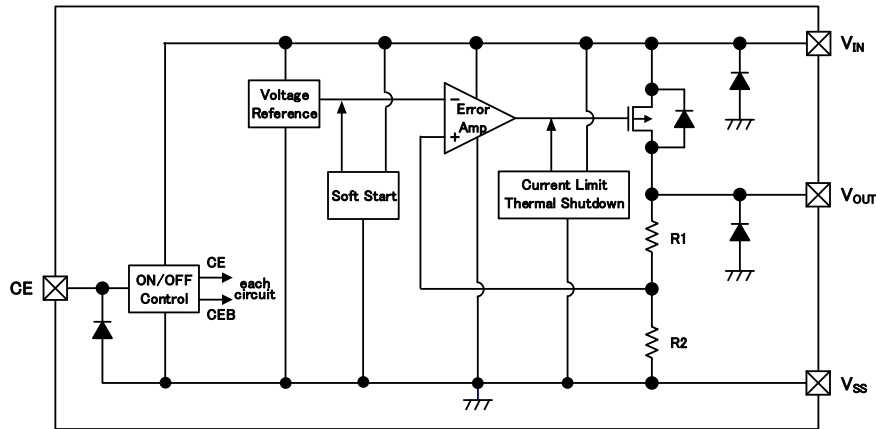

\*The above diodes are diodes for electrostatic protection and parasitic diodes.

## ■ PRODUCT CLASSIFICATION

1) Product code rules

XD6702①②③④⑤⑥-⑦<sup>(\*)</sup>

DESIGNATOR	ITEM	SYMBOL	DESCRIPTION
①	Type	D	Current Limit, Thermal Shutdown, Soft Start, CE function
②③	Output Voltage <sup>(2)</sup>	18 ~ J0 <sup>(3)</sup>	For the voltage within 1.8V ~ 9.5V : e.g. 3.3V → ②=3, ③=3 5.0V → ②=5, ③=0 For the voltage within 10.0V ~ 18.0V : e.g. 10.0V → ②=A, ③=0 12.5V → ②=C, ③=5 18.0V → ②=J, ③=0
④	Output Voltage Accuracy	1	± 1%
⑤⑥-⑦	Packages (Order Unit)	PR-Q <sup>(*)</sup>	SOT-89-5 (1,000pcs/Reel)

<sup>(\*)</sup> The "-Q" suffix denotes "AEC-Q100" and "Halogen and Antimony free" as well as being fully EU RoHS compliant.

<sup>(2)</sup> For other voltages, please contact your local Torex sales office or representative.

<sup>(3)</sup> From 10.0V to 18.0V, A to J excluding I are used in "②".

## ■ STANDARD VOLTAGE

● Examples for standard voltage

V <sub>OUT</sub> (V)	PACKAGES
	SOT-89-5
1.8	XD6702D181PR-Q
2.5	XD6702D251PR-Q
2.8	XD6702D281PR-Q
3.0	XD6702D301PR-Q
3.3	XD6702D331PR-Q
5.0	XD6702D501PR-Q
8.0	XD6702D801PR-Q

## ■ PIN CONFIGURATION

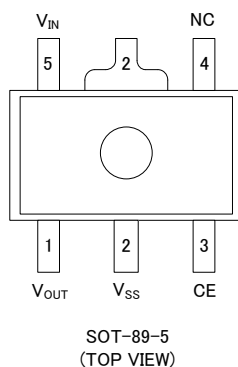

## ■ PIN ASSIGNMENT

PIN NUMBER	PIN NAME	FUNCTIONS
1	V <sub>OUT</sub>	Output
2	V <sub>SS</sub>	Ground
3	CE	ON/OFF Control
4	NC	No Connection
5	V <sub>IN</sub>	Power Input

## ■ PIN FUNCTION ASSIGNMENT

PIN NAME	SIGNAL	STATUS
CE	L	Stand-by
	H	Active
	OPEN	Unstable

\* Avoid leaving the CE pin open ; set to any fixed voltage.

## ■ ABSOLUTE MAXIMUM RATINGS

PARAMETER		SYMBOL	RATINGS	UNITS
Input Voltage		$V_{IN}$	-0.3 ~ 42.0	V
Output Current		$I_{OUT}$	600 <sup>(*1)</sup>	mA
Output Voltage		$V_{OUT}$	-0.3 ~ $V_{IN} + 0.3$ or 42.0 <sup>(*2)</sup>	V
CE Input Voltage		$V_{CE}$	-0.3 ~ 42.0	V
Power Dissipation ( $T_a=25^\circ\text{C}$ )	SOT-89-5	$P_d$	500	mW
			1750 (JESD51-7 board) <sup>(*3)</sup>	
Surge Voltage		$V_{SURGE}$	46.0 <sup>(*4)</sup>	V
Operating Ambient Temperature		$T_{opr}$	-40 ~ 105	$^\circ\text{C}$
Junction Temperature		$T_j$	-40 ~ 125	$^\circ\text{C}$
Storage Temperature		$T_{stg}$	-55 ~ 125	$^\circ\text{C}$

All voltage ratings are relative to  $V_{SS}$ .

(\*1) Use with  $I_{OUT}$  less than  $P_d/(V_{IN}-V_{OUT})$

(\*2) The maximum value is the lower of  $V_{IN} + 0.3\text{V}$  and 42.0V

(\*3) Reference data for continuous power dissipation when mounted on board.

The mounting condition is please refer to PACKAGING INFORMATION.

(\*4) Transient  $\leq 400\text{ms}$

## ELECTRICAL CHARACTERISTICS

PARAMETER	SYMBOL	CONDITIONS	Ta=25°C			-40°C ≤ Ta ≤ 105°C <sup>(6)</sup>			UNITS	CIRCUIT
			MIN.	TYP.	MAX.	MIN.	TYP.	MAX.		
Input Voltage	V <sub>IN</sub>		4.5	-	36.0	4.5	-	36.0	V	①
Output Voltage	V <sub>OUT(E)</sub> <sup>(1)</sup>	I <sub>OUT</sub> =10mA	×0.99	V <sub>OUT(T)</sub> <sup>(2)</sup>	×1.01	×0.96	V <sub>OUT(T)</sub> <sup>(2)</sup>	×1.04	V	①
Quiescent Current	I <sub>SS</sub>	I <sub>OUT</sub> =0mA	-	40	80	-	40	90	μA	②
Stand-by Current	I <sub>STB</sub>	V <sub>IN</sub> =36.0V, V <sub>CE</sub> =V <sub>SS</sub>	-	0.01	0.10	-	0.01	2.10	μA	③
Maximum Output Current <sup>(3)</sup>	I <sub>OUTMAX</sub>	V <sub>IN</sub> =V <sub>OUT(T)</sub> +2.0V	300	-	-	300	-	-	mA	①
Load Regulation	ΔV <sub>OUT</sub>	V <sub>IN</sub> =V <sub>OUT(T)</sub> +2.0V 0.1mA ≤ I <sub>OUT</sub> ≤ 300mA	-	V <sub>OUT(T)</sub> ≤ 5.0V		-	V <sub>OUT(T)</sub> ≤ 5.0V		mV	①
				60	85		60	230		
				V <sub>OUT(T)</sub> > 5.0V			V <sub>OUT(T)</sub> > 5.0V			
			60	130		60	275			
Dropout Voltage	V <sub>dif</sub> <sup>(4)</sup>	I <sub>OUT</sub> =100mA	-	<E-1>		-	<E-1>		mV	①
Line Regulation	ΔV <sub>OUT</sub> / (ΔV <sub>IN</sub> · V <sub>OUT</sub> )	V <sub>OUT(T)</sub> +0.5V ≤ V <sub>IN</sub> ≤ 36.0V	-	0.01	0.03	-	0.01	0.03	%/V	①
Output Voltage Temperature Characteristics	ΔV <sub>OUT</sub> / (ΔT <sub>opr</sub> · V <sub>OUT</sub> )		-	±50	-	-	±50	-	ppm/°C	①
Ripple Rejection Ratio	PSRR	V <sub>IN</sub> =V <sub>OUT(T)</sub> +1.0V <sub>DC</sub> +0.5V <sub>p-pAC</sub> I <sub>OUT</sub> =10mA, f=1kHz C <sub>IN</sub> Unconnected	-	65	-	-	65	-	dB	④
Limit Current <sup>(3)</sup>	I <sub>LIM</sub>	V <sub>IN</sub> =V <sub>OUT(T)</sub> +2.0V V <sub>OUT</sub> =V <sub>OUT(E)</sub> ×0.95	370	460	-	310	460	-	mA	①
Short - Circuit Current	I <sub>SHORT</sub>	V <sub>OUT</sub> =V <sub>SS</sub>	-	115	-	-	115	-	mA	①
Thermal Shutdown Detect Temperature	T <sub>TSD</sub>	Junction Temperature	-	150	-	-	150	-	°C	①
Thermal Shutdown Release Temperature	T <sub>TSR</sub>	Junction Temperature	-	140	-	-	140	-	°C	①
Thermal Shutdown Hysteresis Width	T <sub>TSD</sub> -T <sub>TSR</sub>	Junction Temperature	-	10	-	-	10	-	°C	①
Soft-Start Time <sup>(5)</sup>	t <sub>SS</sub>	V <sub>CE</sub> =0V → V <sub>IN</sub>	-	370	890	-	370	1100	μs	⑤
Inrush Current	I <sub>RUSH</sub>	V <sub>CE</sub> =0V → V <sub>IN</sub>	-	V <sub>OUT(T)</sub> ≤ 3.3V		-	V <sub>OUT(T)</sub> ≤ 3.3V		mA	⑤
				55	95		55	155		
				3.3V < V <sub>OUT(T)</sub> ≤ 5.0V			3.3V < V <sub>OUT(T)</sub> ≤ 5.0V			
				70	135		70	215		
			V <sub>OUT(T)</sub> > 5.0V			V <sub>OUT(T)</sub> > 5.0V				
			125	210		125	330			
CE "H" Level Voltage	V <sub>CEH</sub>		2.5	-	36.0	2.5	-	36.0	V	⑥
CE "L" Level Voltage	V <sub>CEL</sub>		V <sub>SS</sub>	-	1.2	V <sub>SS</sub>	-	1.2	V	⑥
CE "H" Level Current	I <sub>CEH</sub>	V <sub>CE</sub> =V <sub>IN</sub> =36.0V	-0.10	-	0.10	-0.10	-	0.10	μA	⑥
CE "L" Level Current	I <sub>CEL</sub>	V <sub>IN</sub> =36.0V, V <sub>CE</sub> =V <sub>SS</sub>	-0.10	-	0.10	-0.10	-	0.10	μA	⑥

V<sub>IN</sub> = V<sub>OUT(T)</sub> + 1.0V, V<sub>CE</sub> = V<sub>IN</sub>, I<sub>OUT</sub> = 1mA, C<sub>IN</sub> = 1.0μF, C<sub>L</sub> = 2.2μF unless otherwise specified.

This parameter is tested on V<sub>IN</sub>=4.5V if the input voltage is under 4.5V.

<sup>(1)</sup> V<sub>OUT(E)</sub>: Actual output voltage value.

<sup>(2)</sup> V<sub>OUT(T)</sub>: Set output voltage value.

<sup>(3)</sup> Differences in heat dissipation when mounted may cause activation of thermal shutdown circuit, preventing attainment of maximum output current.

<sup>(4)</sup> V<sub>dif</sub> is defined as follows: V<sub>dif</sub>={V<sub>IN1</sub>-V<sub>OUT1</sub>}.

V<sub>IN1</sub>: As input voltage is gradually reduced, the input voltage at which V<sub>OUT1</sub> is output.

V<sub>OUT1</sub>: 98% of output voltage when V<sub>IN</sub> is input after stabilizing sufficiently at I<sub>OUT</sub>=100mA.

<sup>(5)</sup> Time from input of voltage higher than CE "H" level voltage into CE pin until output voltage is V<sub>OUT(T)</sub> × 0.9V or higher.

<sup>(6)</sup> The values under -40°C ≤ Ta ≤ 105°C has been tested and guaranteed by design engineering.

## ELECTRICAL CHARACTERISTICS (Continued)

Voltage Chart 1 <E-0>

NOMINAL OUTPUT VOLTAGE	<E-0>			
	Output Voltage $V_{OUT(E)}$ (V)			
	$T_a=25^\circ\text{C}$		$-40^\circ\text{C} \leq T_a \leq 105^\circ\text{C}$	
$V_{OUT(T)}$ (V)	MIN.	MAX.	MIN.	MAX.
1.8	1.782	1.818	1.728	1.872
1.9	1.881	1.919	1.824	1.976
2.0	1.980	2.020	1.920	2.080
2.1	2.079	2.121	2.016	2.184
2.2	2.178	2.222	2.112	2.288
2.3	2.277	2.323	2.208	2.392
2.4	2.376	2.424	2.304	2.496
2.5	2.475	2.525	2.400	2.600
2.6	2.574	2.626	2.496	2.704
2.7	2.673	2.727	2.592	2.808
2.8	2.772	2.828	2.688	2.912
2.9	2.871	2.929	2.784	3.016
3.0	2.970	3.030	2.880	3.120
3.1	3.069	3.131	2.976	3.224
3.2	3.168	3.232	3.072	3.328
3.3	3.267	3.333	3.168	3.432
3.4	3.366	3.434	3.264	3.536
3.5	3.465	3.535	3.360	3.640
3.6	3.564	3.636	3.456	3.744
3.7	3.663	3.737	3.552	3.848
3.8	3.762	3.838	3.648	3.952
3.9	3.861	3.939	3.744	4.056
4.0	3.960	4.040	3.840	4.160
4.1	4.059	4.141	3.936	4.264
4.2	4.158	4.242	4.032	4.368
4.3	4.257	4.343	4.128	4.472
4.4	4.356	4.444	4.224	4.576
4.5	4.455	4.545	4.320	4.680
4.6	4.554	4.646	4.416	4.784
4.7	4.653	4.747	4.512	4.888
4.8	4.752	4.848	4.608	4.992
4.9	4.851	4.949	4.704	5.096
5.0	4.950	5.050	4.800	5.200

NOMINAL OUTPUT VOLTAGE	<E-0>			
	Output Voltage $V_{OUT(E)}$ (V)			
	$T_a=25^\circ\text{C}$		$-40^\circ\text{C} \leq T_a \leq 105^\circ\text{C}$	
$V_{OUT(T)}$ (V)	MIN.	MAX.	MIN.	MAX.
5.1	5.049	5.151	4.896	5.304
5.2	5.148	5.252	4.992	5.408
5.3	5.247	5.353	5.088	5.512
5.4	5.346	5.454	5.184	5.616
5.5	5.445	5.555	5.280	5.720
5.6	5.544	5.656	5.376	5.824
5.7	5.643	5.757	5.472	5.928
5.8	5.742	5.858	5.568	6.032
5.9	5.841	5.959	5.664	6.136
6.0	5.940	6.060	5.760	6.240
6.5	6.435	6.565	6.240	6.760
7.0	6.930	7.070	6.720	7.280
7.5	7.425	7.575	7.200	7.800
8.0	7.920	8.080	7.680	8.320
8.5	8.415	8.585	8.160	8.840
9.0	8.910	9.090	8.640	9.360
9.5	9.405	9.595	9.120	9.880
10.0	9.900	10.100	9.600	10.400
10.5	10.395	10.605	10.080	10.920
11.0	10.890	11.110	10.560	11.440
11.5	11.385	11.615	11.040	11.960
12.0	11.880	12.120	11.520	12.480
12.5	12.375	12.625	12.000	13.000
13.0	12.870	13.130	12.480	13.520
13.5	13.365	13.635	12.960	14.040
14.0	13.860	14.140	13.440	14.560
14.5	14.355	14.645	13.920	15.080
15.0	14.850	15.150	14.400	15.600
15.5	15.345	15.655	14.880	16.120
16.0	15.840	16.160	15.360	16.640
16.5	16.335	16.665	15.840	17.160
17.0	16.830	17.170	16.320	17.680
17.5	17.325	17.675	16.800	18.200
18.0	17.820	18.180	17.280	18.720

**■ ELECTRICAL CHARACTERISTICS (Continued)**

Voltage Chart 1 <E-1>

NOMINAL OUTPUT VOLTAGE	<E-1>					
	Dropout Voltage Vdif (mV) (I <sub>OUT</sub> = 100mA)					
	Ta=25°C		-40°C ≤ Ta ≤ 105°C			
V <sub>OUT(T)</sub> (V)	TYP.	MAX.	TYP.	MAX.		
1.8	1480	2700	1480	2700		
1.9	1440	2600	1440	2600		
2.0	1230	2500	1230	2500		
2.1		2400		2400		
2.2	1090	2300	1090	2300		
2.3		2200		2200		
2.4	1030	2100	1030	2100		
2.5		2000		2000		
2.6	670	1900	670	1900		
2.7		1800		1800		
2.8	460	1700	460	1700		
2.9		1600		1600		
3.0	450	1500	450	1500		
3.1		1400		1400		
3.2		1300		1300		
3.3	430	1200	430	1200		
3.4		1100		1100		
3.5		1000		1000		
3.6		900		900		
3.7		800				
3.8		700				
3.9		600				
4.0		530			530	900
4.1						
4.2						
4.3						
4.4						
4.5						
4.6						
4.7						
4.8						
4.9						

NOMINAL OUTPUT VOLTAGE	<E-1>			
	Dropout Voltage Vdif (mV) (I <sub>OUT</sub> = 100mA)			
	Ta=25°C		-40°C ≤ Ta ≤ 105°C	
V <sub>OUT(T)</sub> (V)	TYP.	MAX.	TYP.	MAX.
5.0	350	440	350	810
5.1				
5.2				
5.3				
5.4				
5.5				
5.6				
5.7				
5.8				
5.9				
6.0				
6.5				
7.0				
7.5				
8.0				
8.5				
9.0				
9.5				
10.0				
10.5				
11.0				
11.5				
12.0				
12.5				
13.0				
13.5				
14.0				
14.5				
15.0				
15.5				
16.0				
16.5				
17.0				
17.5				
18.0				

## TEST CIRCUITS

CIRCUIT①

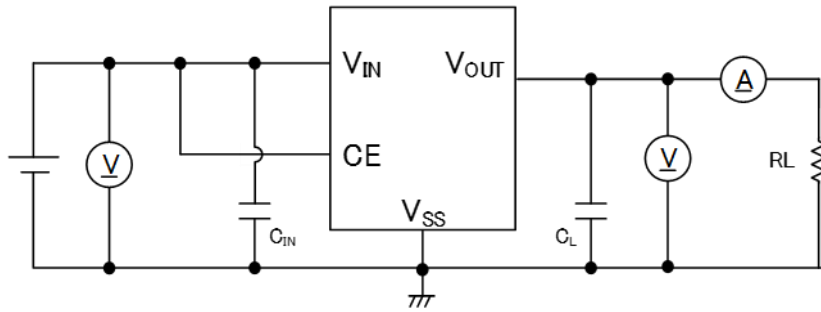

CIRCUIT②

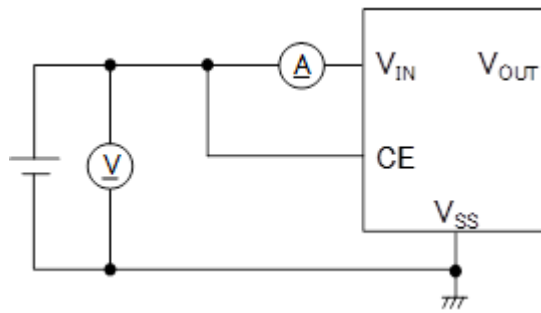

CIRCUIT③

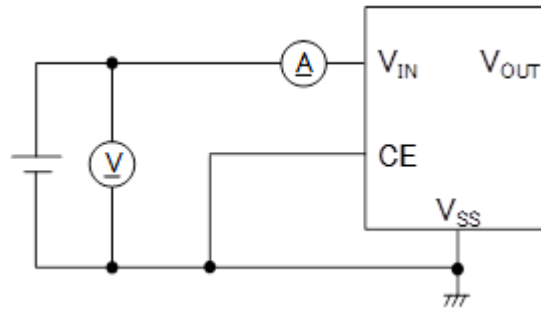

CIRCUIT④

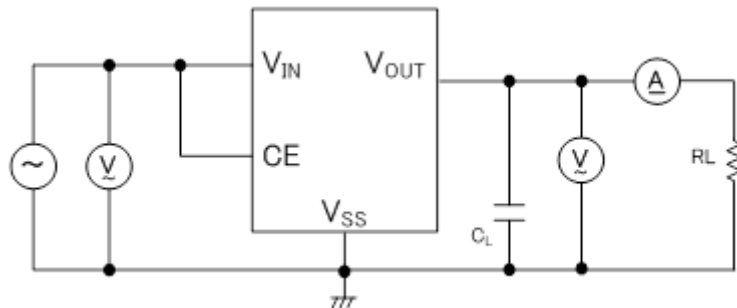



**TEST CIRCUITS**

CIRCUIT⑤

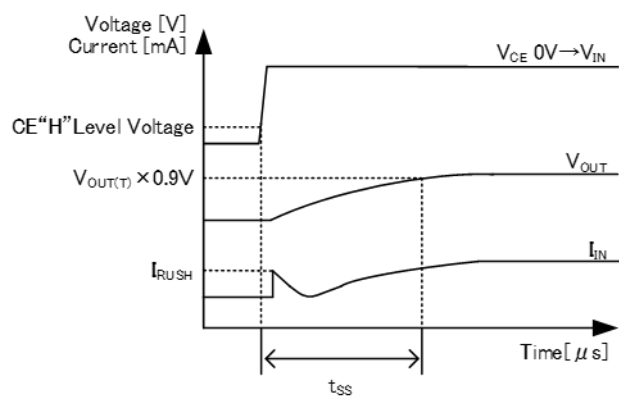
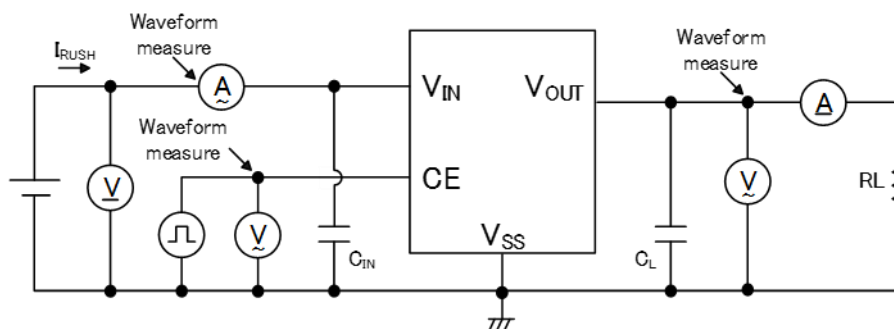

CIRCUIT⑥

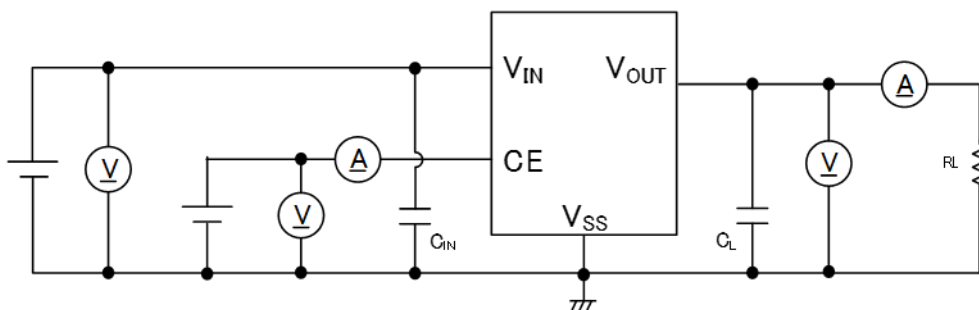

## OPERATIONAL EXPLANATION

The XD6702 series controls the output voltage by means of a scheme in which the error amplifier compares the voltage divided by R1 and R2 connected to the V<sub>OUT</sub> pin with the voltage of the internal reference power supply. The output signal from the error amplifier makes the driver transistor connected to the V<sub>IN</sub> pin drive, and negative feedback is applied to stabilize the output voltage.

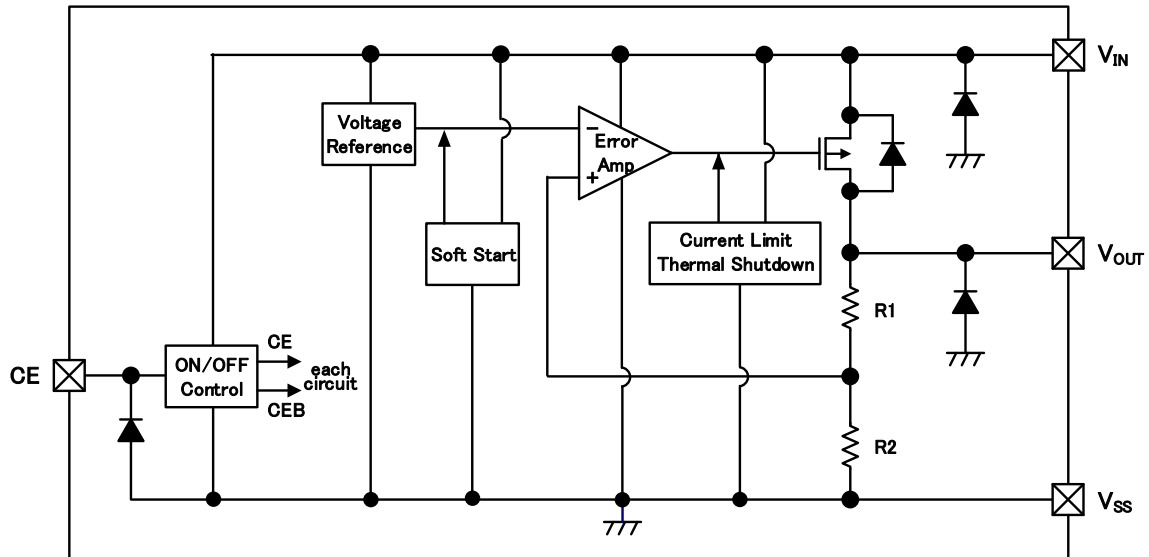

\* The above diodes are diodes for electrostatic protection and parasitic diodes.

### <Current limiting, short-circuit protection>

The XD6702 series incorporates a foldback circuit for current limiting(460mA TYP.) and short-circuit protection(115mA TYP.).

When the output current reaches the current limit, the output voltage falls and the output current is limited.

### <Overheating protection>

The XD6702 series incorporates a thermal shutdown circuit for overheating protection.

When the junction temperature reaches the detection temperature  $T_{TSD}$ (150°C TYP.), the driver transistor is forcibly turned off.

When the junction temperature falls to the release temperature  $T_{TSR}$ (140°C TYP.) while the driver transistor remains in the off state, the driver transistor turns on (auto recovery) and regulation restarts.

Unless the cause of rising temperature is removed, the driver transistor repeats on and off, and output waveform would be like consecutive pulses.

### <CE function>

The XD6702 series allows stopping of the IC internal circuit by a CE pin signal.

When the IC is in the stopped state by CE "L" level voltage input, the V<sub>OUT</sub> pin is pulled down by R1 and R2 to the V<sub>SS</sub> level.

As long as the voltage input into the CE pin is within the CE pin voltage specification, the logic is established and there is no interference with operation. If the CE pin is left open, operation is unspecified.

## ■ OPERATIONAL EXPLANATION (Continued)

### <Soft start>

The XD6702 series limits the rush current ( $I_{RUSH}$ ) that suddenly flows from  $V_{IN}$  to  $V_{OUT}$  to charge the output capacitor ( $C_L$ ) when the IC starts, and is also able to limit fluctuations of  $V_{IN}$  due to  $I_{RUSH}$ . The soft start time ( $t_{SS}$ ) is optimized internally (370 $\mu$ s TYP.). The soft start time ( $t_{SS}$ ) is defined as the  $V_{OUT}$  reaches 90% of  $V_{OUT(T)}$  from the time when CE H threshold is input to the CE pin.

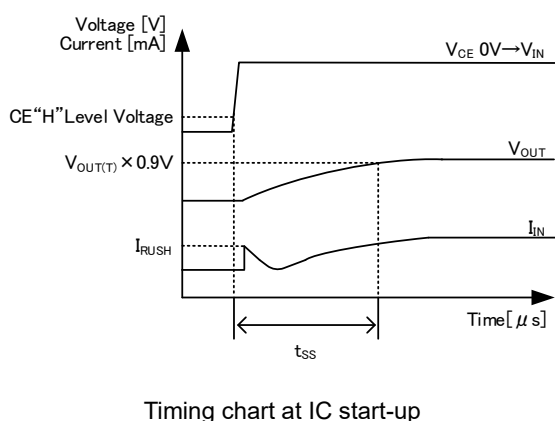

Timing chart at IC start-up

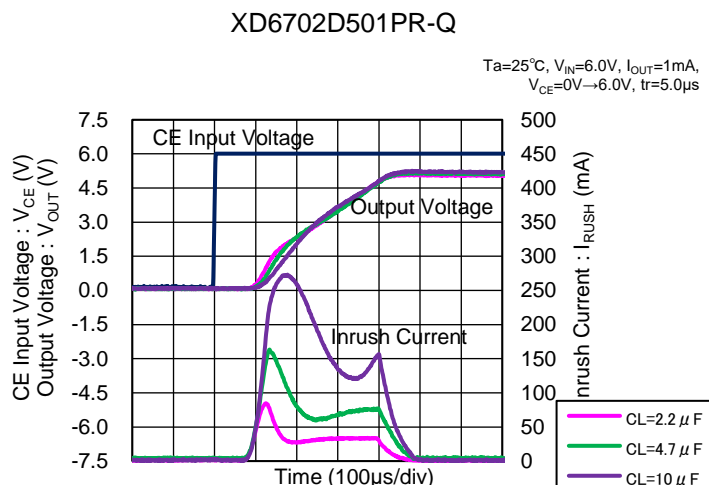

Example of the inrush current wave form at IC start-up

### <Low ESR capacitor support>

An internal phase compensation circuit is incorporated in the XD6702 series to enable a stable output voltage to be obtained even when a low ESR capacitor is used. To stabilize the effect of the phase compensation circuit, always connect the output capacitor ( $C_L$ ) in direct proximity to the  $V_{OUT}$  pin and  $V_{SS}$  pin. In addition, to stabilize the input power, connect the input capacitor ( $C_{IN}$ ) in direct proximity to the  $V_{IN}$  pin and  $V_{SS}$  pin. Refer to Table 1 for the recommended capacitance values to be connected.

Take particular care in selecting the capacitors for  $C_{IN}$  and  $C_L$ , as the bias dependence of the capacitor, the effect of capacitance loss due to temperature characteristics and other factors, and the effects of ESR may prevent stable phase compensation. Table 1 shows recommended capacitance values (MIN) for the actual bias and temperature conditions used for the capacitor. Select capacitances that satisfy Table 1 in all environments in which the product is to be used.

Table 1: Recommended capacitance values (MIN) of  $C_{IN}$  and  $C_L$

OUTPUT VOLTAGE RANGE $V_{OUT(T)}$	INPUT CAPACITOR $C_{IN}$	OUTPUT CAPACITOR $C_L$
1.8V ~ 18.0V	1.0 $\mu$ F	2.2 $\mu$ F

## ■ Notes on use

- 1) For temporary, transitional voltage drop or voltage rising phenomenon, the IC is liable to malfunction should the ratings be exceeded.
- 2) Where wiring impedance is high, operations may become unstable due to noise and/or phase lag depending on output current. Please keep the resistance low between  $V_{IN}$  and  $V_{SS}$  wiring in particular.
- 3) Please wire the input capacitor ( $C_{IN}$ ) and the output capacitor ( $C_L$ ) as close to the IC as possible.
- 4) Capacitances of these capacitors ( $C_{IN}$ ,  $C_L$ ) are decreased by the influences of DC bias voltage and ambient temperature. Care shall be taken for capacitor selection to ensure stability of phase compensation from the point of ESR influence.
- 5) Regarding the input transient response, the undershoot at the output voltage might be larger when input voltage variation is 5.0V or larger and the through-rate is 0.5V/ $\mu$ s or higher.  
If the undershoot is not acceptable, please increase the output capacitance value and evaluate the system on your PCB well.
- 6) The IC goes into "undefined state" if the CE pin is not connected (Open state).  
The CE pin voltage should be fixed in low or high for stable operation.
- 7) If a capacitor with large capacitance is used on the output, the inrush current can oscillate at starting up.
- 8) Starting up the IC while the voltage less than 0V is applied to the output can lead to cases where it does not start normally.
- 9) In general, semiconductor components have a possibility to have variation of electrical specifications due to the (cosmic) radiation exposure. Therefore this product has the same possibility. Please inform us in advance if your system might have a possibility to be exposed to the (cosmic) radiation in the production process (assembly, test, etc.).
- 10) Torex places an importance on improving our products and their reliability.  
We request that users incorporate fail-safe designs and post-aging prevention treatment when using Torex products in their systems.

## ■ TYPICAL PERFORMANCE CHARACTERISTICS

Ta=25°C, V<sub>IN</sub> = V<sub>OUT</sub>(T) + 1.0V, V<sub>CE</sub> = V<sub>IN</sub>, I<sub>OUT</sub> = 1mA, C<sub>IN</sub> = 1.0μF, C<sub>L</sub> = 2.2μF(ceramic) unless otherwise specified.  
This parameter is tested on V<sub>IN</sub>=4.5V if the input voltage is under 4.5V.

### (1) Output Voltage vs. Output Current

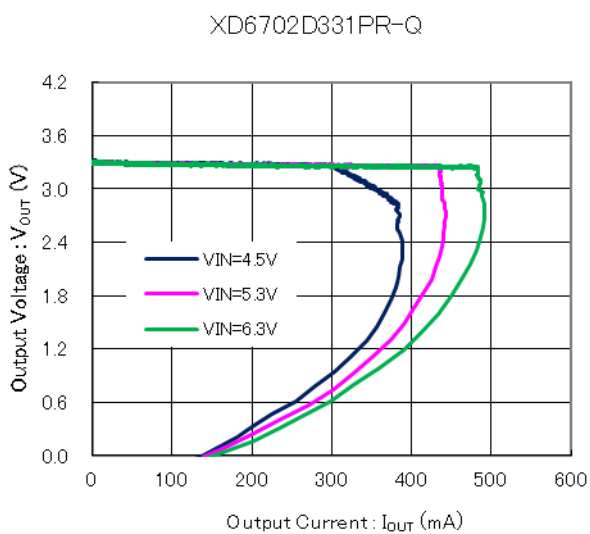
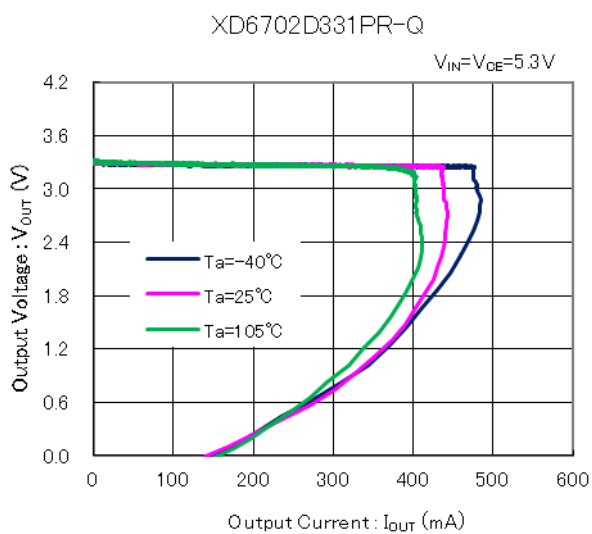
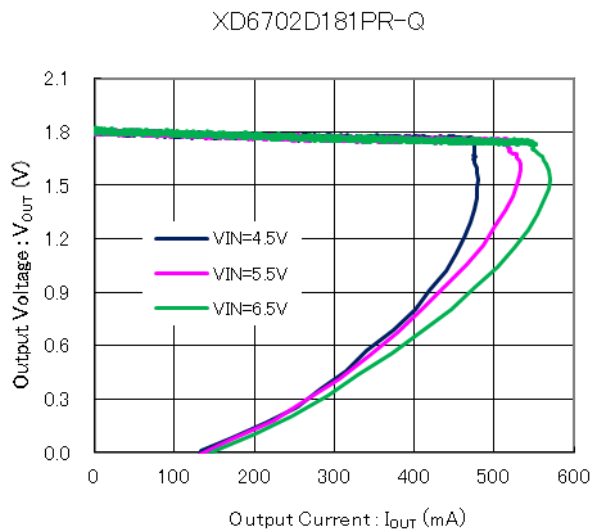
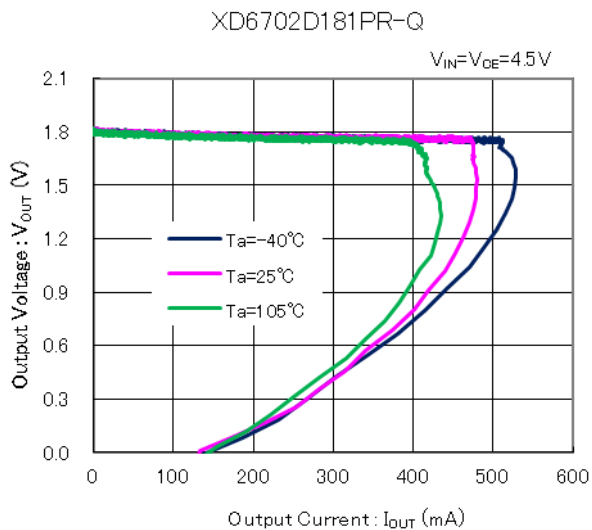

\* Mount conditions affect heat dissipation. Thermal shutdown may start to operate.

## TYPICAL PERFORMANCE CHARACTERISTICS(Continued)

$T_a=25^{\circ}\text{C}$ ,  $V_{IN} = V_{OUT}(T) + 1.0\text{V}$ ,  $V_{CE} = V_{IN}$ ,  $I_{OUT} = 1\text{mA}$ ,  $C_{IN} = 1.0\mu\text{F}$ ,  $C_L = 2.2\mu\text{F}$ (ceramic) unless otherwise specified.  
 This parameter is tested on  $V_{IN}=4.5\text{V}$  if the input voltage is under 4.5V.

### (1) Output Voltage vs. Output Current

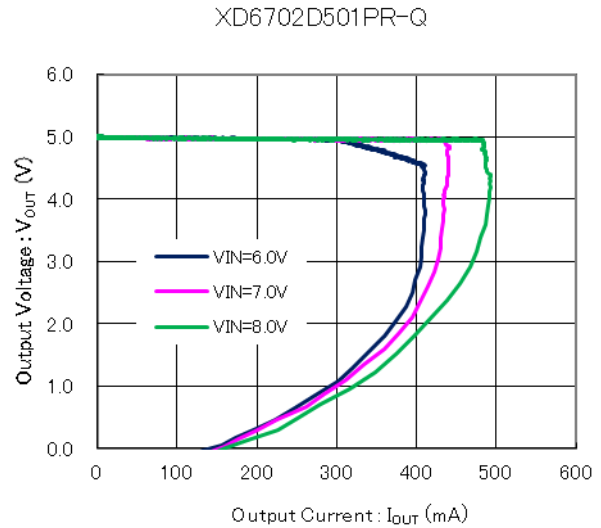
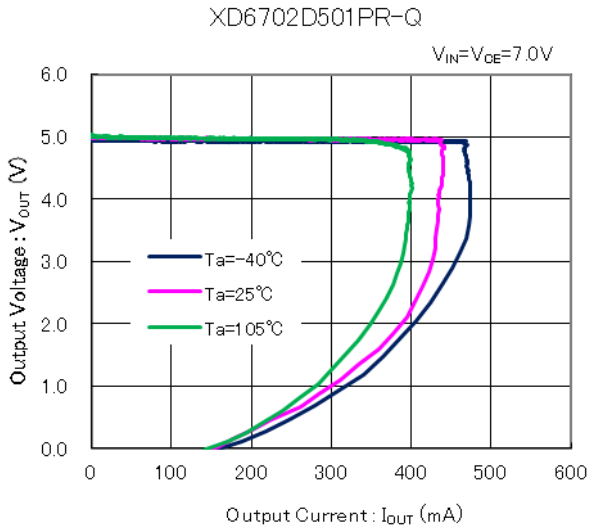

\* Mount conditions affect heat dissipation. Thermal shutdown may start to operate.

### (2) Output Voltage vs. Input Voltage

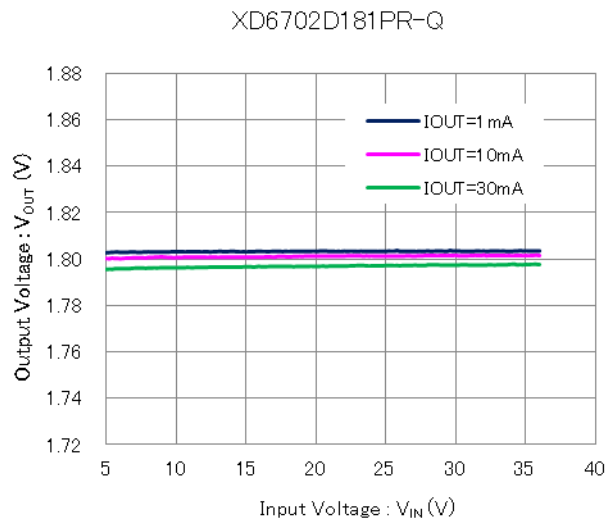
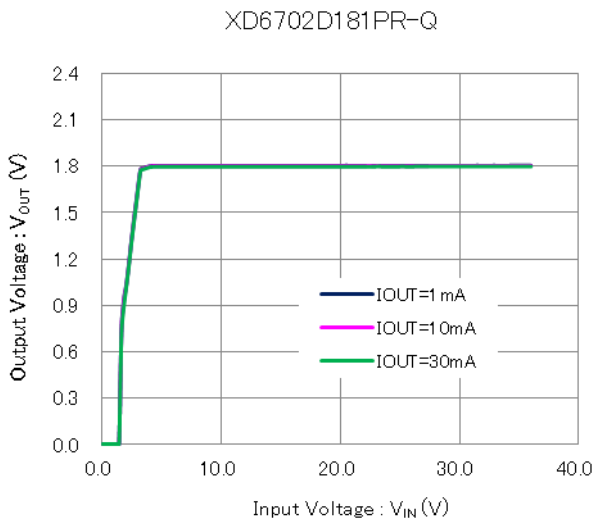

## ■ TYPICAL PERFORMANCE CHARACTERISTICS(Continued)

Ta=25°C,  $V_{IN} = V_{OUT}(T) + 1.0V$ ,  $V_{CE} = V_{IN}$ ,  $I_{OUT} = 1mA$ ,  $C_{IN} = 1.0\mu F$ ,  $C_L = 2.2\mu F$ (ceramic) unless otherwise specified.  
This parameter is tested on  $V_{IN}=4.5V$  if the input voltage is under 4.5V.

### (2) Output Voltage vs. Input Voltage

XD6702D331PR-Q

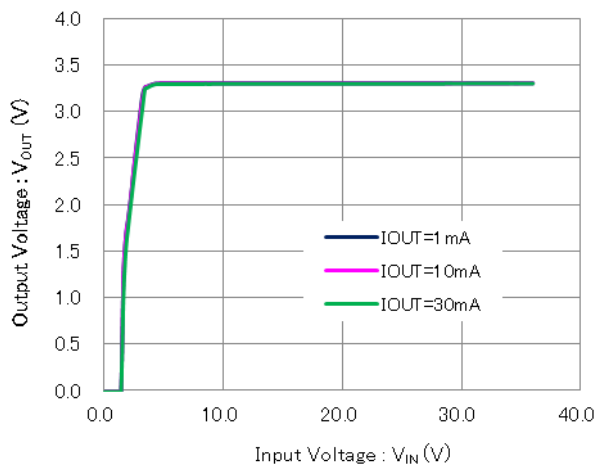

XD6702D331PR-Q

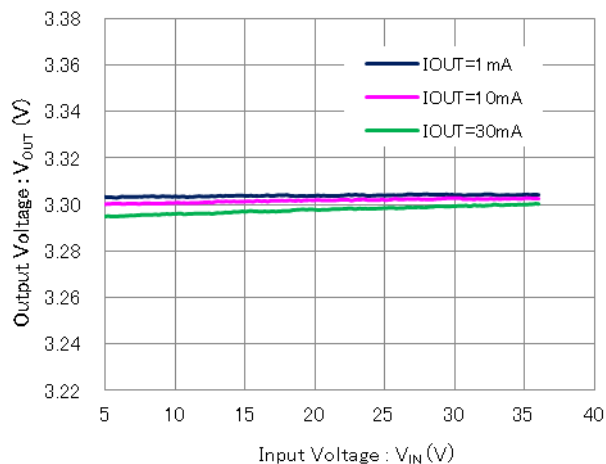

XD6702D501PR-Q

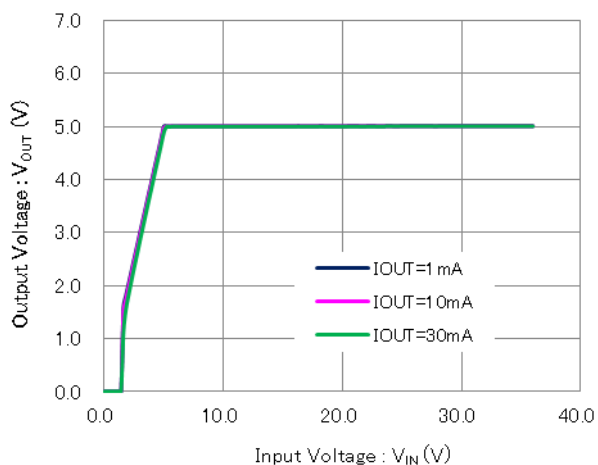

XD6702D501PR-Q

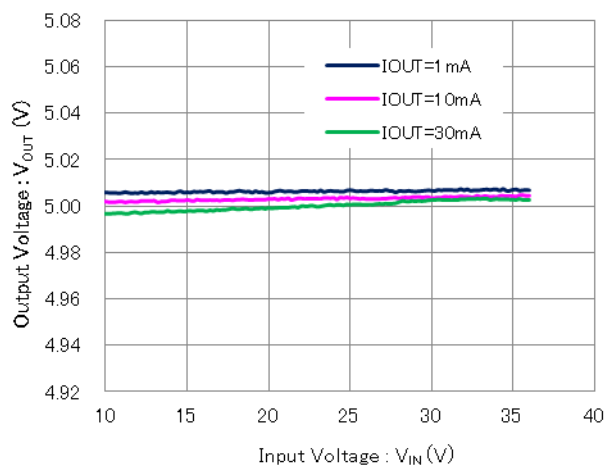

## TYPICAL PERFORMANCE CHARACTERISTICS(Continued)

$T_a=25^\circ\text{C}$ ,  $V_{IN} = V_{OUT}(T) + 1.0\text{V}$ ,  $V_{CE} = V_{IN}$ ,  $I_{OUT} = 1\text{mA}$ ,  $C_{IN} = 1.0\mu\text{F}$ ,  $C_L = 2.2\mu\text{F}$ (ceramic) unless otherwise specified.  
 This parameter is tested on  $V_{IN}=4.5\text{V}$  if the input voltage is under 4.5V.

### (3) Dropout Voltage vs. Output Current

XD6702D181PR-Q

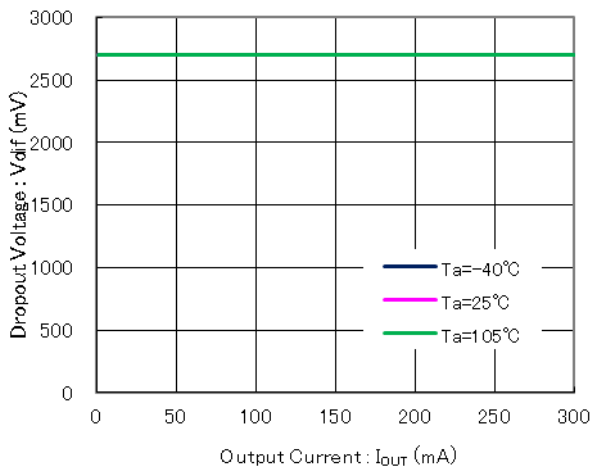

XD6702D331PR-Q

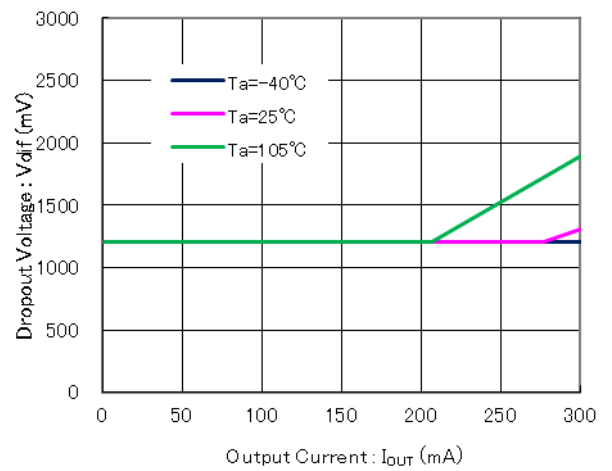

XD6702D501PR-Q

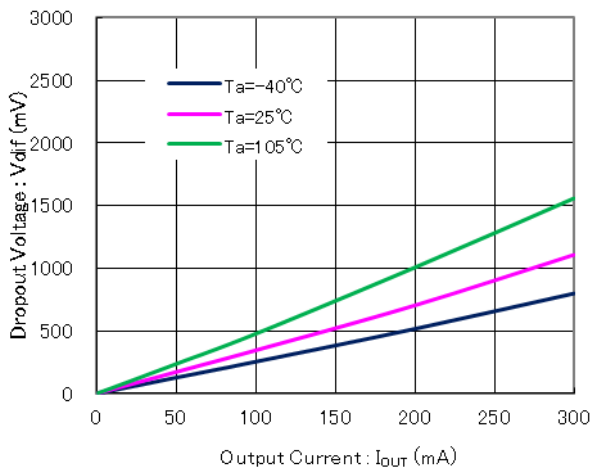

\* Mount conditions affect heat dissipation. Thermal shutdown may start to operate.



## ■ TYPICAL PERFORMANCE CHARACTERISTICS(Continued)

$T_a=25^{\circ}\text{C}$ ,  $V_{IN} = V_{OUT}(T) + 1.0\text{V}$ ,  $V_{CE} = V_{IN}$ ,  $I_{OUT} = 1\text{mA}$ ,  $C_{IN} = 1.0\mu\text{F}$ ,  $C_L = 2.2\mu\text{F}$ (ceramic) unless otherwise specified.  
This parameter is tested on  $V_{IN}=4.5\text{V}$  if the input voltage is under 4.5V.

### (4) Quiescent Current vs. Input Voltage

XD6702D181PR-Q

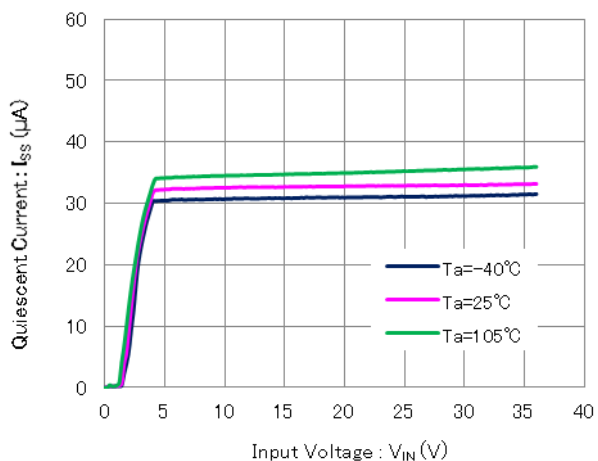

XD6702D331PR-Q

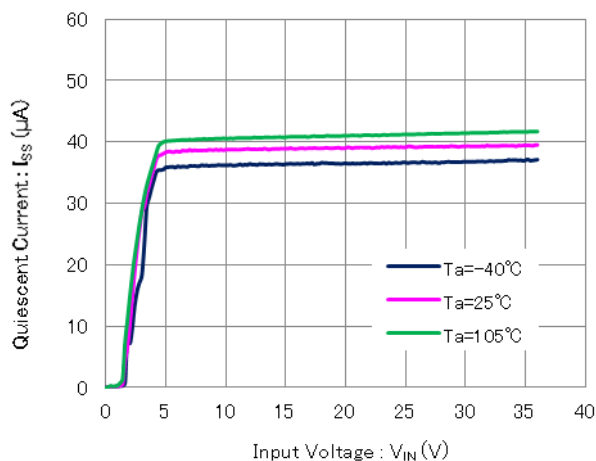

XD6702D501PR-Q

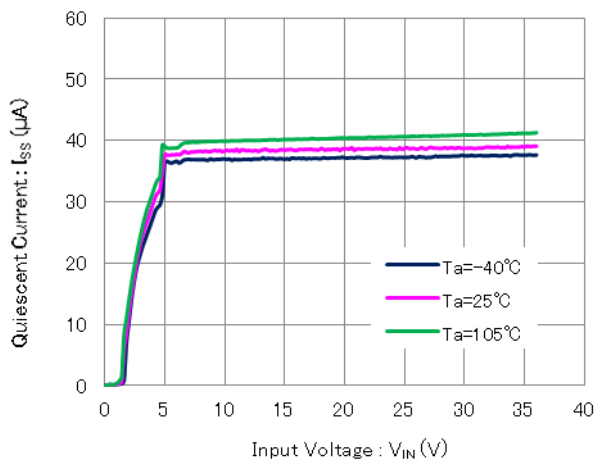

## ■ TYPICAL PERFORMANCE CHARACTERISTICS(Continued)

$T_a=25^{\circ}\text{C}$ ,  $V_{\text{IN}} = V_{\text{OUT}}(T) + 1.0\text{V}$ ,  $V_{\text{CE}} = V_{\text{IN}}$ ,  $I_{\text{OUT}} = 1\text{mA}$ ,  $C_{\text{IN}} = 1.0\mu\text{F}$ ,  $C_{\text{L}} = 2.2\mu\text{F}$ (ceramic) unless otherwise specified.  
 This parameter is tested on  $V_{\text{IN}}=4.5\text{V}$  if the input voltage is under 4.5V.

### (5) Output Voltage vs. Ambient Temperature

XD6702D181PR-Q

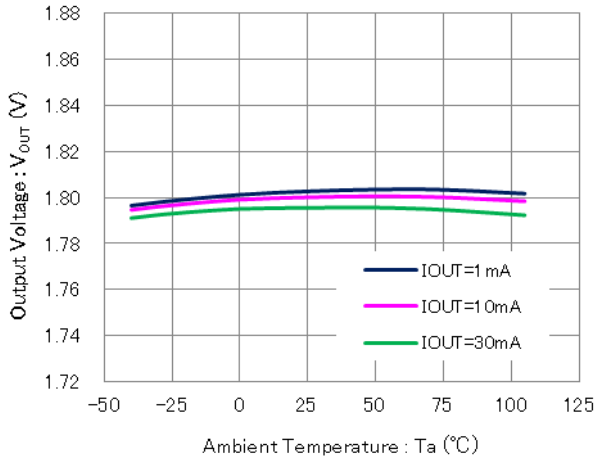

XD6702D331PR-Q

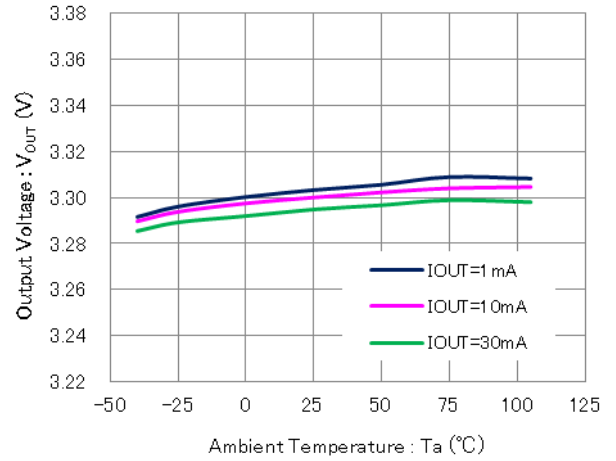

XD6702D501PR-Q

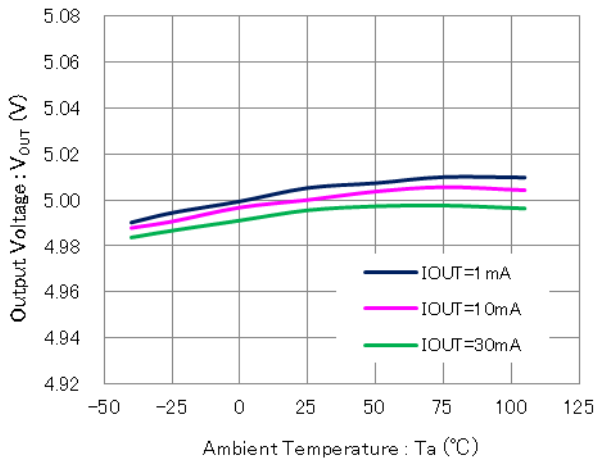

## ■ TYPICAL PERFORMANCE CHARACTERISTICS(Continued)

$T_a=25^{\circ}\text{C}$ ,  $V_{\text{IN}} = V_{\text{OUT}}(T) + 1.0\text{V}$ ,  $V_{\text{CE}} = V_{\text{IN}}$ ,  $I_{\text{OUT}} = 1\text{mA}$ ,  $C_{\text{IN}} = 1.0\mu\text{F}$ ,  $C_{\text{L}} = 2.2\mu\text{F}$ (ceramic) unless otherwise specified.  
This parameter is tested on  $V_{\text{IN}}=4.5\text{V}$  if the input voltage is under 4.5V.

### (6) Quiescent Current vs. Ambient Temperature

XD6702D181PR-Q

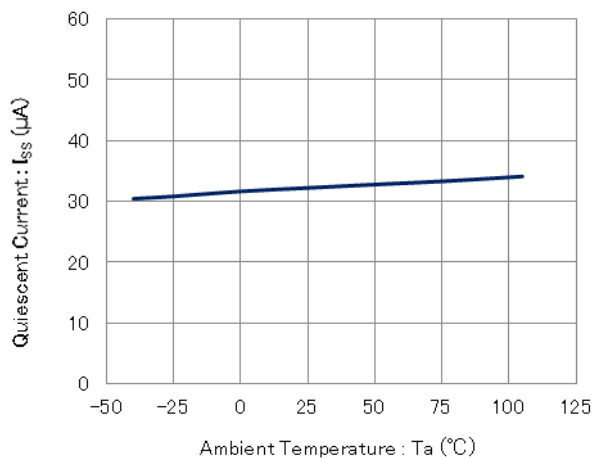

XD6702D331PR-Q

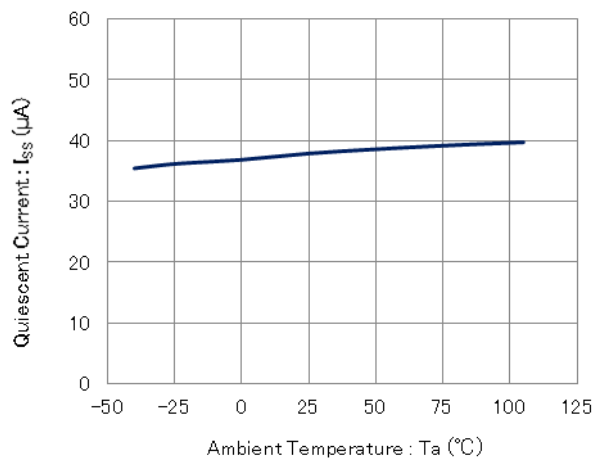

XD6702D501PR-Q

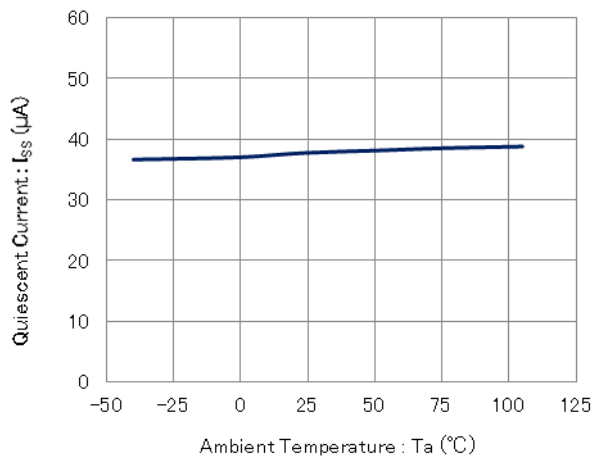

## ■ TYPICAL PERFORMANCE CHARACTERISTICS(Continued)

$T_a=25^{\circ}\text{C}$ ,  $V_{IN} = V_{OUT}(T) + 1.0\text{V}$ ,  $V_{CE} = V_{IN}$ ,  $I_{OUT} = 1\text{mA}$ ,  $C_{IN} = 1.0\mu\text{F}$ ,  $C_L = 2.2\mu\text{F}$ (ceramic) unless otherwise specified.  
 This parameter is tested on  $V_{IN}=4.5\text{V}$  if the input voltage is under 4.5V.

### (7) CE Threshold Voltage vs. Ambient Temperature

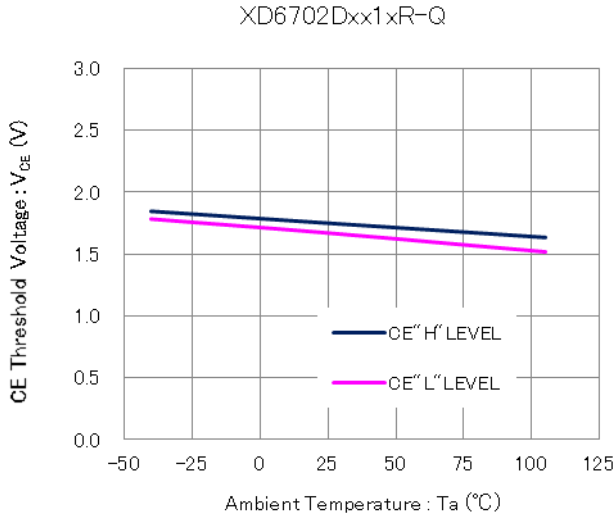

### (8) Input Transient Response

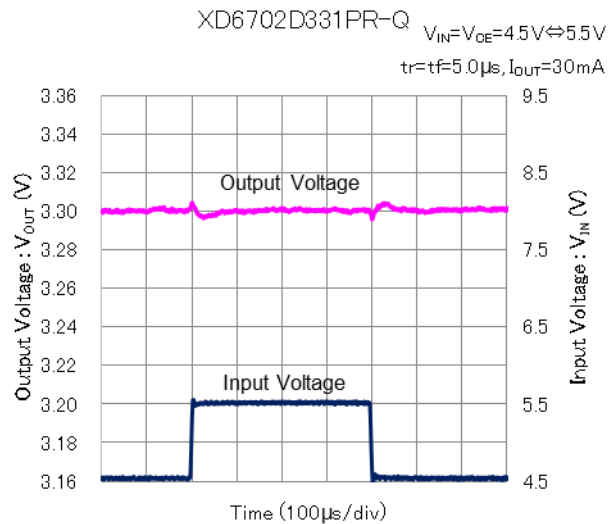
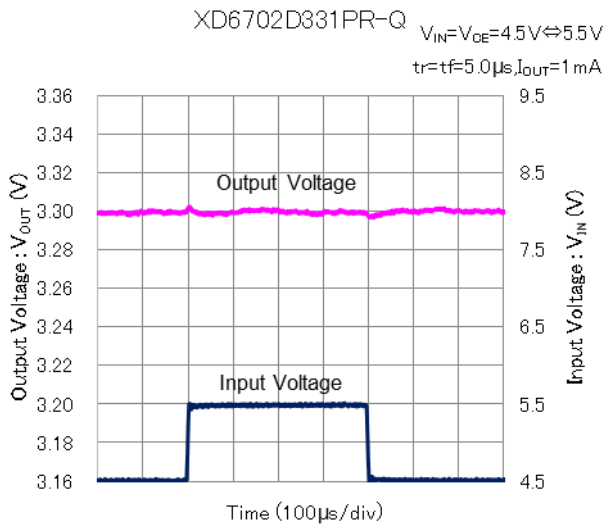
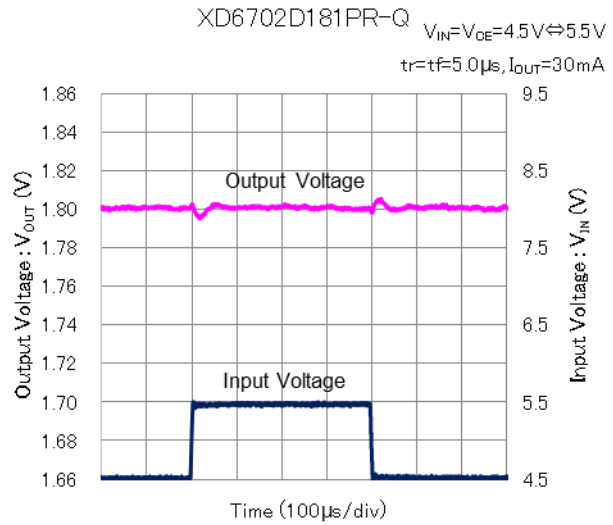
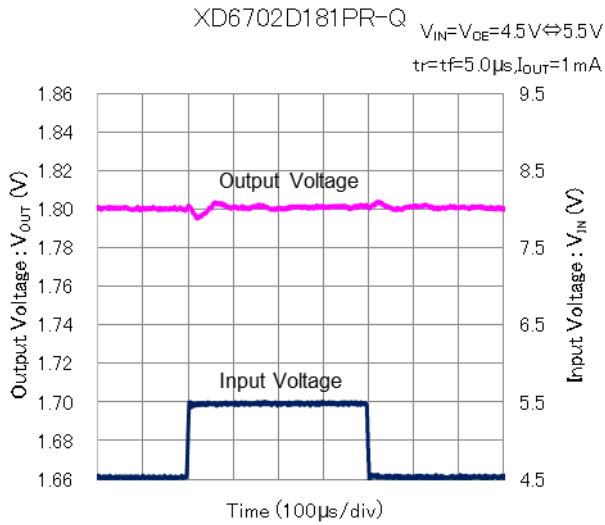

## TYPICAL PERFORMANCE CHARACTERISTICS(Continued)

Ta=25°C, V<sub>IN</sub> = V<sub>OUT(T)</sub> + 1.0V, V<sub>CE</sub> = V<sub>IN</sub>, I<sub>OUT</sub> = 1mA, C<sub>IN</sub> = 1.0μF, C<sub>L</sub> = 2.2μF(ceramic) unless otherwise specified.

This parameter is tested on V<sub>IN</sub>=4.5V if the input voltage is under 4.5V.

### (8) Input Transient Response

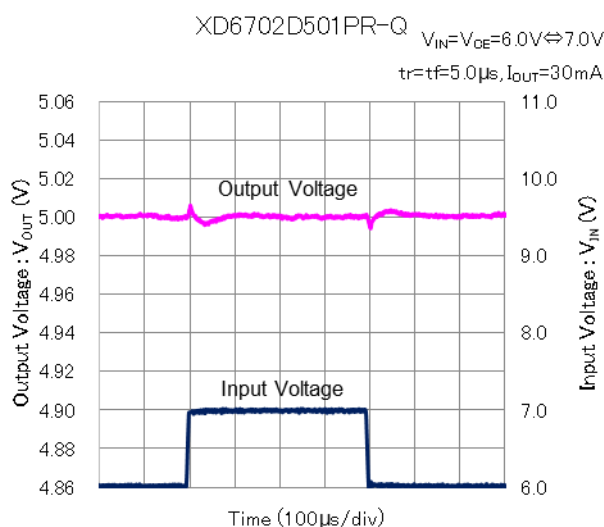
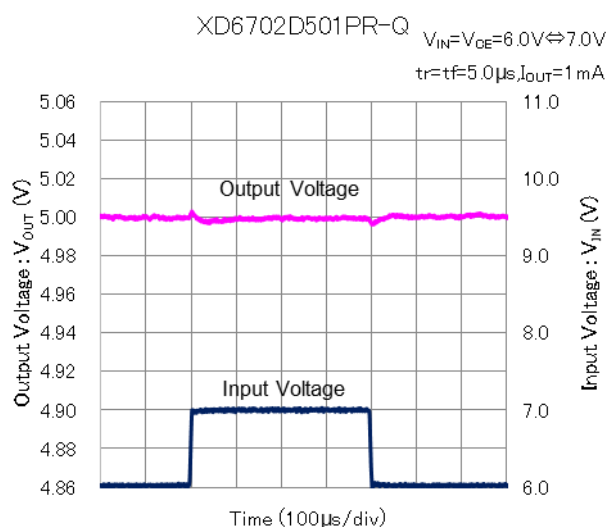

### (9) Load Transient Response

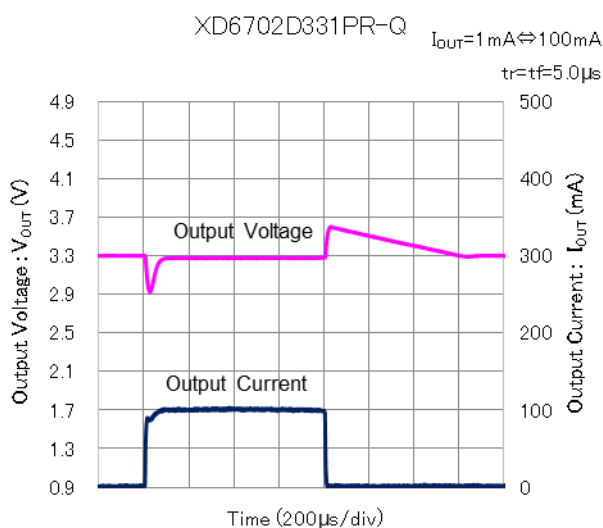
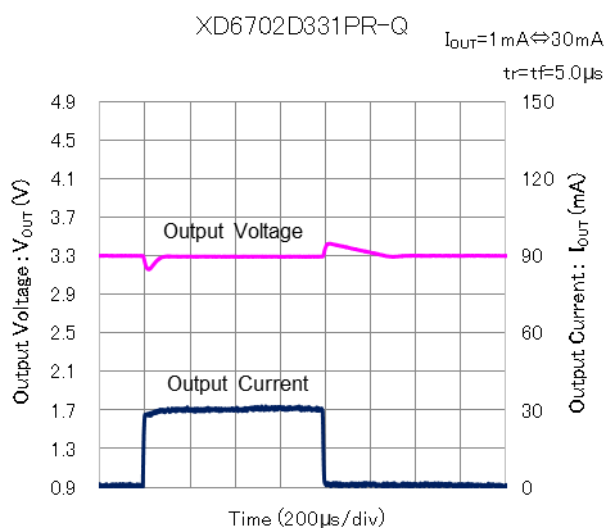
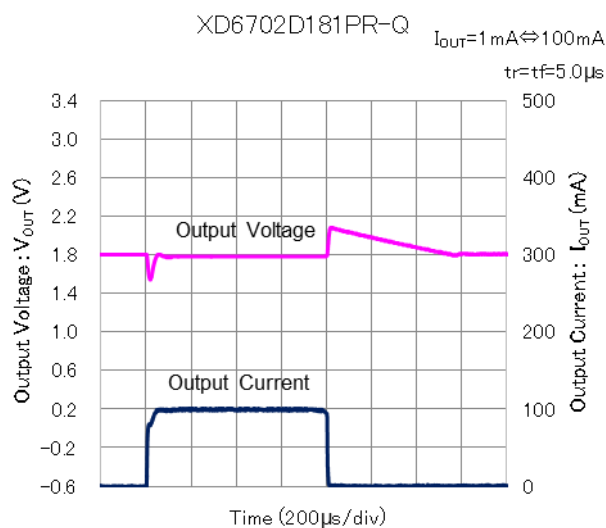
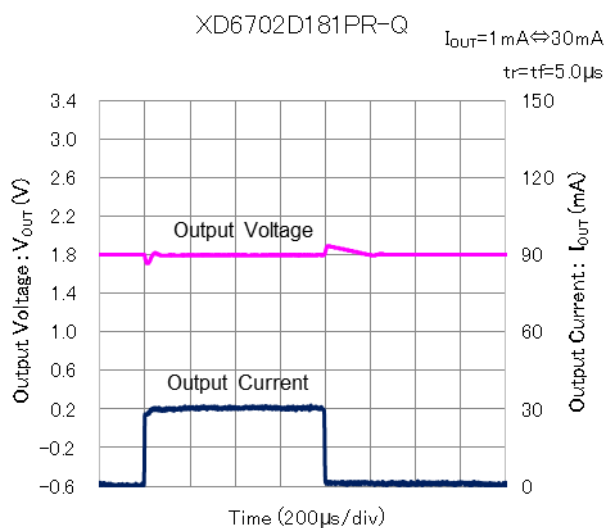

## TYPICAL PERFORMANCE CHARACTERISTICS(Continued)

$T_a=25^{\circ}\text{C}$ ,  $V_{IN} = V_{OUT}(T) + 1.0\text{V}$ ,  $V_{CE} = V_{IN}$ ,  $I_{OUT} = 1\text{mA}$ ,  $C_{IN} = 1.0\mu\text{F}$ ,  $C_L = 2.2\mu\text{F}$ (ceramic) unless otherwise specified.  
 This parameter is tested on  $V_{IN}=4.5\text{V}$  if the input voltage is under 4.5V.

### (9) Load Transient Response

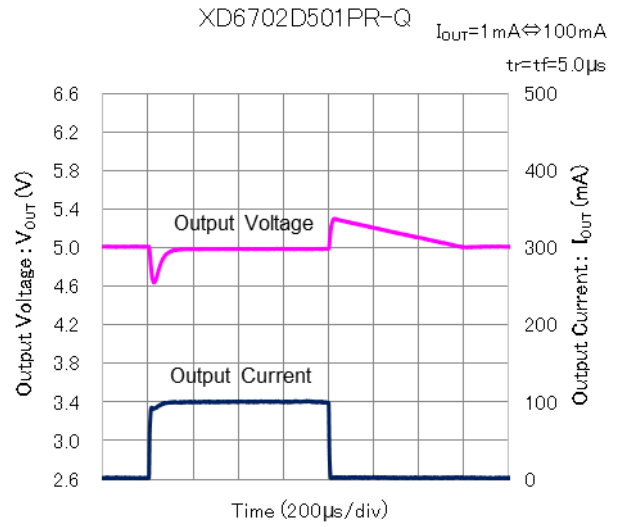
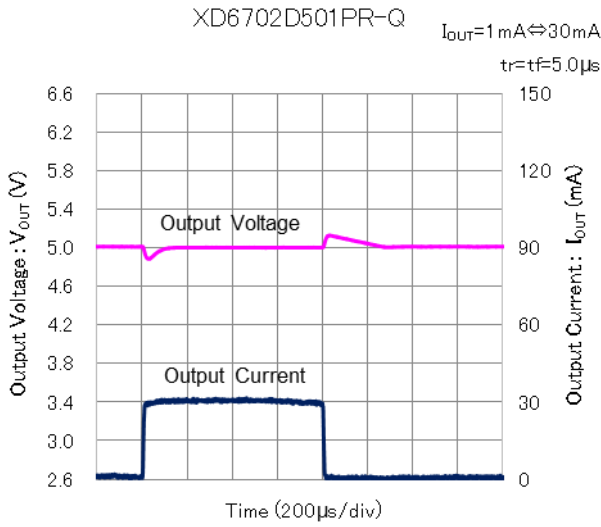

### (10) Input Rising Response Time

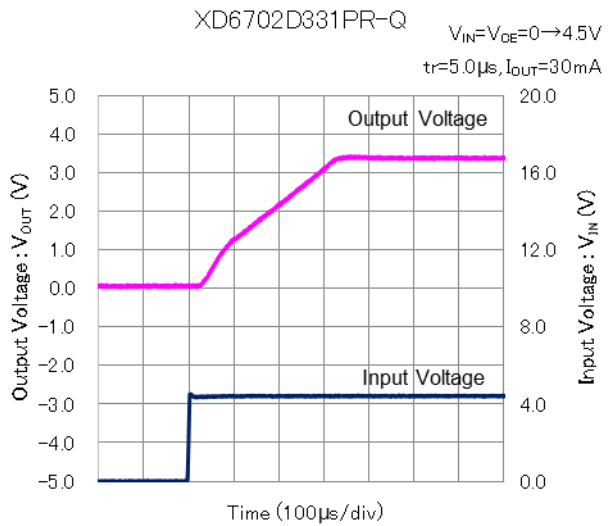
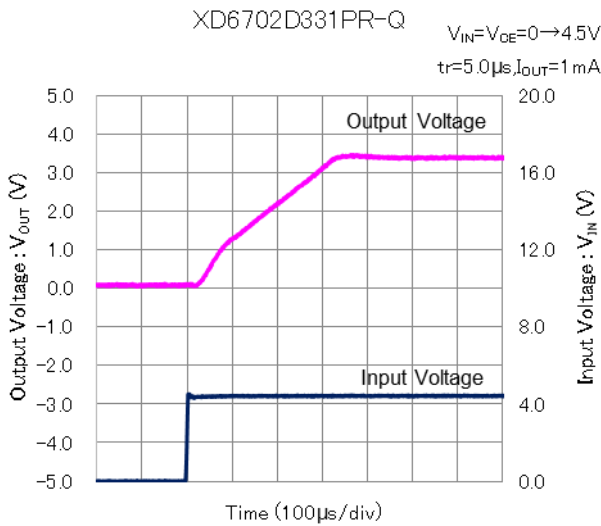
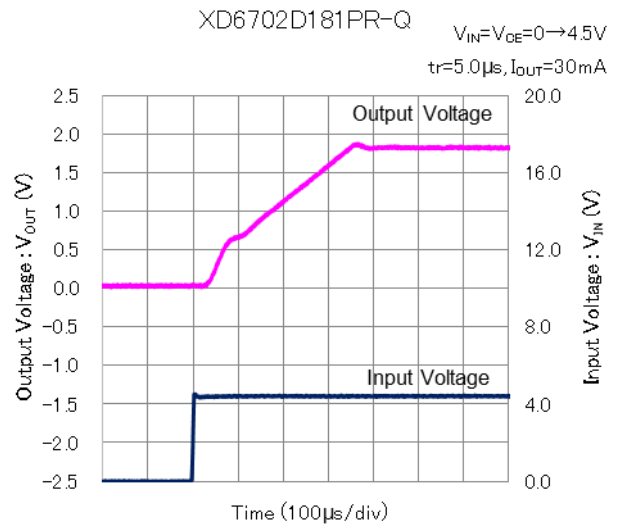
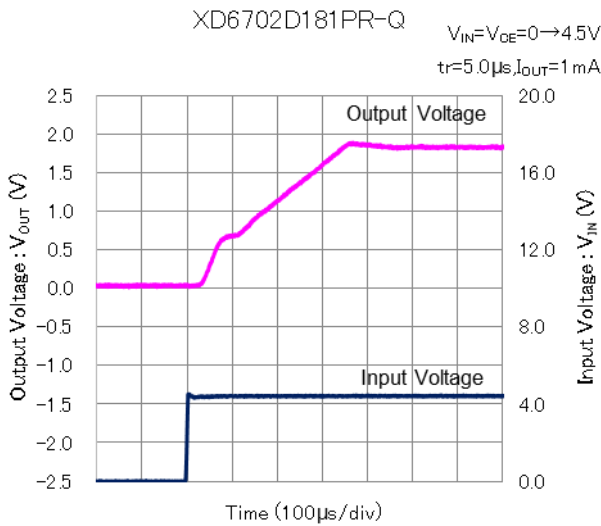

## ■ TYPICAL PERFORMANCE CHARACTERISTICS(Continued)

Ta=25°C, V<sub>IN</sub> = V<sub>OUT(T)</sub> + 1.0V, V<sub>CE</sub> = V<sub>IN</sub>, I<sub>OUT</sub> = 1mA, C<sub>IN</sub> = 1.0μF, C<sub>L</sub> = 2.2μF(ceramic) unless otherwise specified.

This parameter is tested on V<sub>IN</sub>=4.5V if the input voltage is under 4.5V.

### (10) Input Rising Response Time

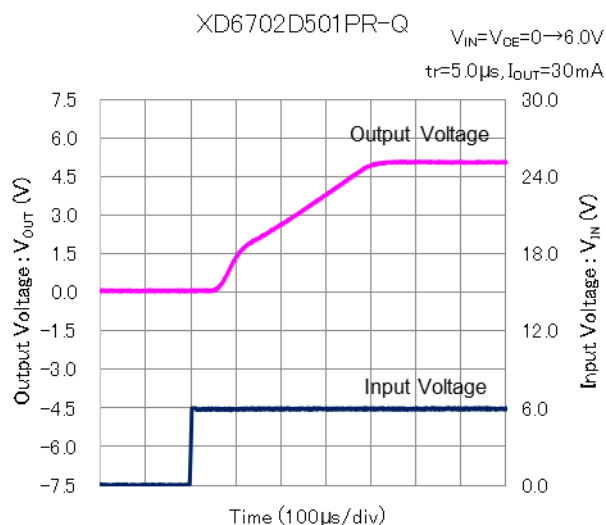
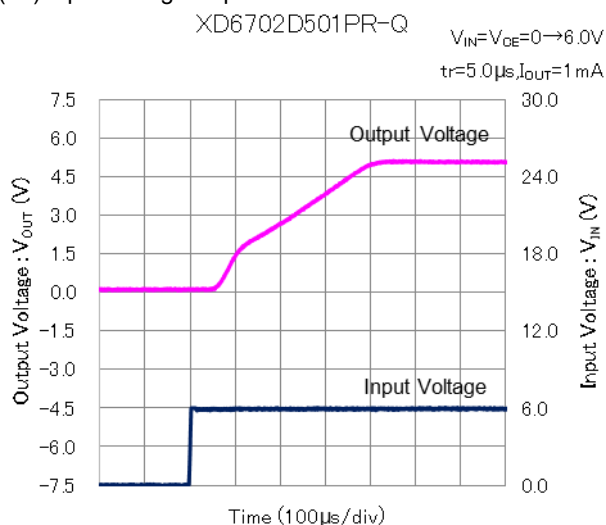

### (11) CE Rising Response Time

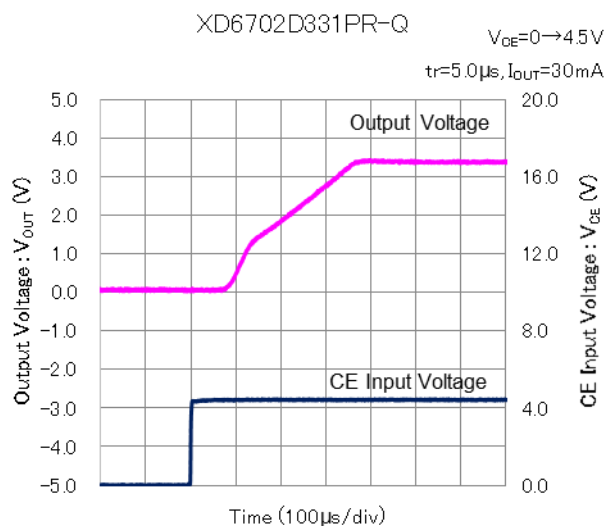
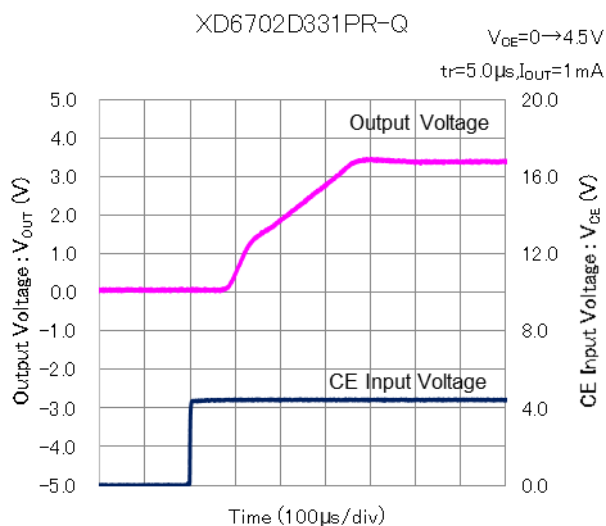
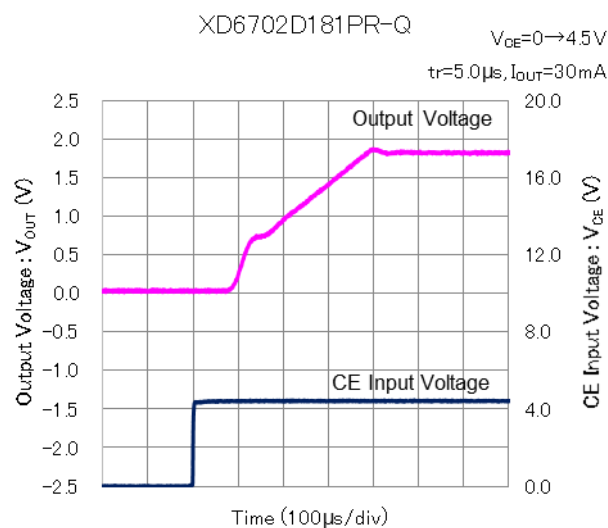
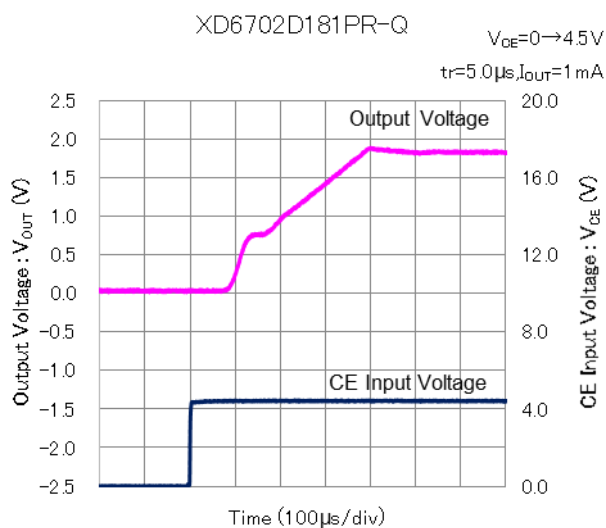

## TYPICAL PERFORMANCE CHARACTERISTICS(Continued)

$T_a=25^{\circ}\text{C}$ ,  $V_{IN} = V_{OUT}(T) + 1.0\text{V}$ ,  $V_{CE} = V_{IN}$ ,  $I_{OUT} = 1\text{mA}$ ,  $C_{IN} = 1.0\mu\text{F}$ ,  $C_L = 2.2\mu\text{F}$ (ceramic) unless otherwise specified.  
 This parameter is tested on  $V_{IN}=4.5\text{V}$  if the input voltage is under 4.5V.

### (11) CE Rising Response Time

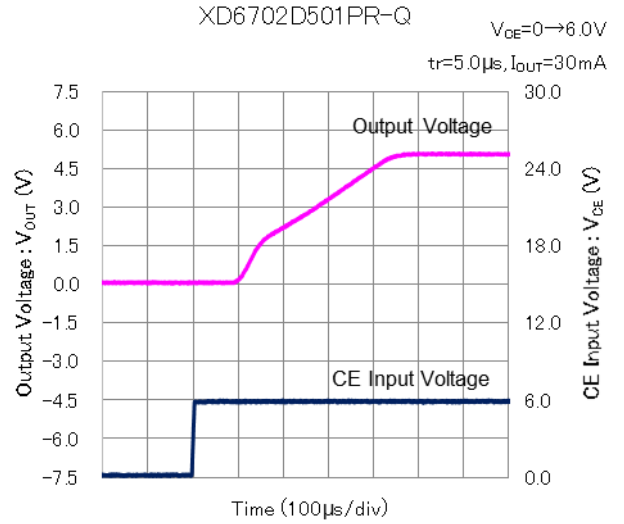
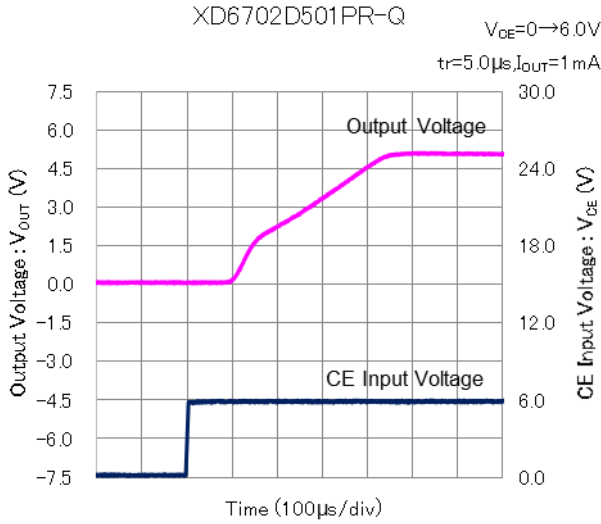

### (12) Power Supply Ripple Rejection Ratio

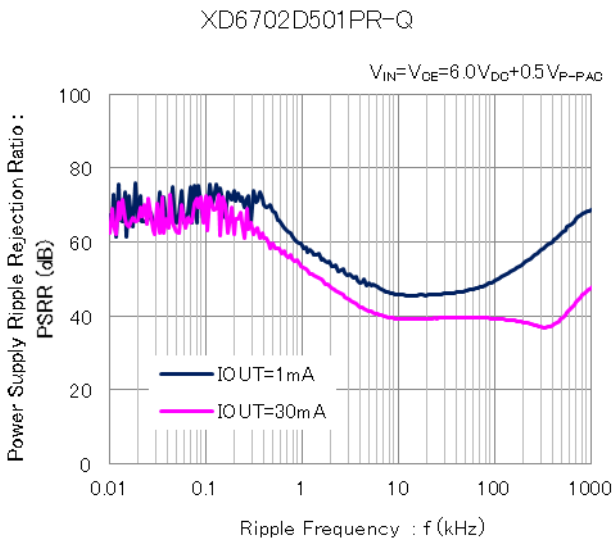
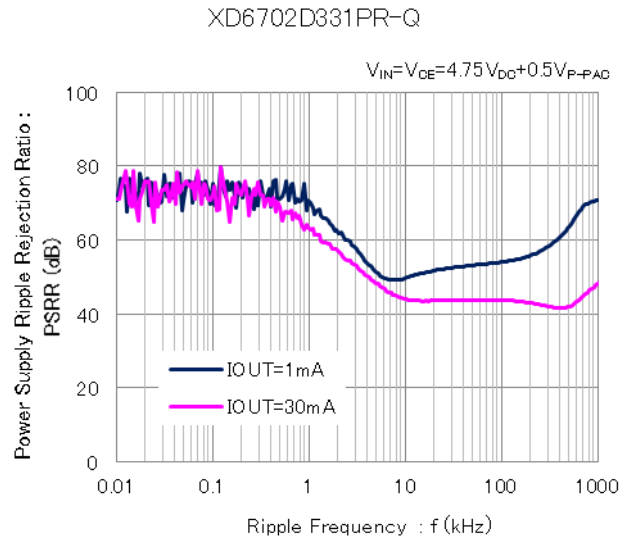
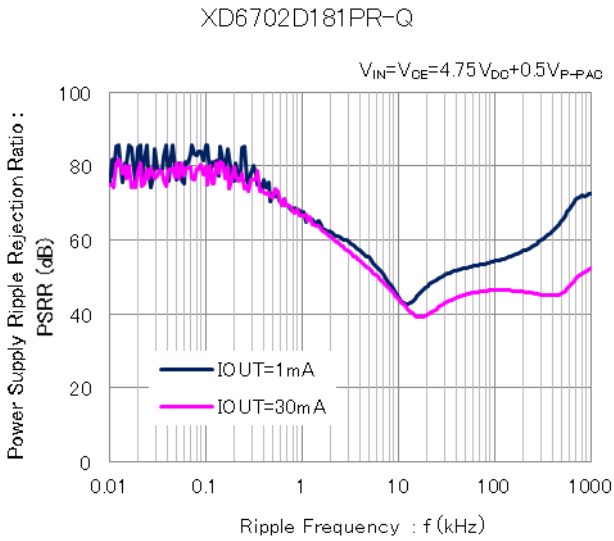



## ■ PACKAGING INFORMATION

For the latest package information go to, [www.torexsemi.com/technical-support/packages](http://www.torexsemi.com/technical-support/packages)

PACKAGE	OUTLINE / LAND PATTERN	THERMAL CHARACTERISTICS
SOT-89-5	<a href="#">SOT-89-5 PKG</a>	<a href="#">SOT-89-5 Power Dissipation</a>

## PRODUCT CLASSIFICATION

●SOT-89-5

SOT-89-5

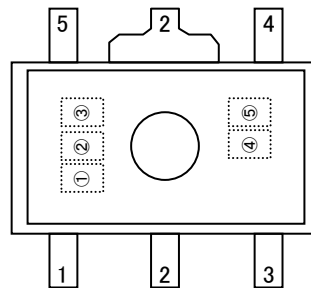

(mark header: ①~③) \*mark header does not change with a lot.

① represents product series

MARK	PRODUCT SERIES
L	XD6702*****-Q

② represents type of regulators and output voltage

MARK	TYPE	OUTPUT VOLTAGE(V)
4	1.8~3.0	XD6702D*****-Q
5	3.1~6.0	
6	6.1~9.0	
7	9.1~12.0	
C	12.1~15.0	
D	15.1~18.0	

③ represents output voltage.

MARK	OUTPUT VOLTAGE (V)						MARK	OUTPUT VOLTAGE (V)					
0	-	3.1	6.1	9.1	12.1	15.1	F	-	4.6	7.6	10.6	13.6	16.6
1	-	3.2	6.2	9.2	12.2	15.2	H	-	4.7	7.7	10.7	13.7	16.7
2	-	3.3	6.3	9.3	12.3	15.3	K	1.8	4.8	7.8	10.8	13.8	16.8
3	-	3.4	6.4	9.4	12.4	15.4	L	1.9	4.9	7.9	10.9	13.9	16.9
4	-	3.5	6.5	9.5	12.5	15.5	M	2.0	5.0	8.0	11.0	14.0	17.0
5	-	3.6	6.6	9.6	12.6	15.6	N	2.1	5.1	8.1	11.1	14.1	17.1
6	-	3.7	6.7	9.7	12.7	15.7	P	2.2	5.2	8.2	11.2	14.2	17.2
7	-	3.8	6.8	9.8	12.8	15.8	R	2.3	5.3	8.3	11.3	14.3	17.3
8	-	3.9	6.9	9.9	12.9	15.9	S	2.4	5.4	8.4	11.4	14.4	17.4
9	-	4.0	7.0	10.0	13.0	16.0	T	2.5	5.5	8.5	11.5	14.5	17.5
A	-	4.1	7.1	10.1	13.1	16.1	U	2.6	5.6	8.6	11.6	14.6	17.6
B	-	4.2	7.2	10.2	13.2	16.2	V	2.7	5.7	8.7	11.7	14.7	17.7
C	-	4.3	7.3	10.3	13.3	16.3	X	2.8	5.8	8.8	11.8	14.8	17.8
D	-	4.4	7.4	10.4	13.4	16.4	Y	2.9	5.9	8.9	11.9	14.9	17.9
E	-	4.5	7.5	10.5	13.5	16.5	Z	3.0	6.0	9.0	12.0	15.0	18.0

④,⑤represents production lot number

01~09, 0A~0Z, 11~9Z, A1~A9, AA~AZ, B1~ZZ in order.

(G, I, J, O, Q, W excluded)

\* No character inversion used.

1. The product and product specifications contained herein are subject to change without notice to improve performance characteristics. Consult us, or our representatives before use, to confirm that the information in this datasheet is up to date.
2. The information in this datasheet is intended to illustrate the operation and characteristics of our products. We neither make warranties or representations with respect to the accuracy or completeness of the information contained in this datasheet nor grant any license to any intellectual property rights of ours or any third party concerning with the information in this datasheet.
3. Applicable export control laws and regulations should be complied and the procedures required by such laws and regulations should also be followed, when the product or any information contained in this datasheet is exported.
4. The product is neither intended nor warranted for use in equipment of systems which require extremely high levels of quality and/or reliability and/or a malfunction or failure which may cause loss of human life, bodily injury, serious property damage including but not limited to devices or equipment used in 1) nuclear facilities, 2) aerospace industry, 3) medical facilities, 4) automobile industry and other transportation industry and 5) safety devices and safety equipment to control combustions and explosions, excluding when specified for in-vehicle use or other uses.  
Do not use the product for in-vehicle use or other uses unless agreed by us in writing in advance.
5. Although we make continuous efforts to improve the quality and reliability of our products; nevertheless Semiconductors are likely to fail with a certain probability. So in order to prevent personal injury and/or property damage resulting from such failure, customers are required to incorporate adequate safety measures in their designs, such as system fail safes, redundancy and fire prevention features.
6. Our products are not designed to be Radiation-resistant.
7. Please use the product listed in this datasheet within the specified ranges.
8. We assume no responsibility for damage or loss due to abnormal use.
9. All rights reserved. No part of this datasheet may be copied or reproduced unless agreed by Torex Semiconductor Ltd in writing in advance.

TOREX SEMICONDUCTOR LTD.