

Dual INT-A-PAK Low Profile “Half Bridge” (Standard Speed IGBT), 400 A

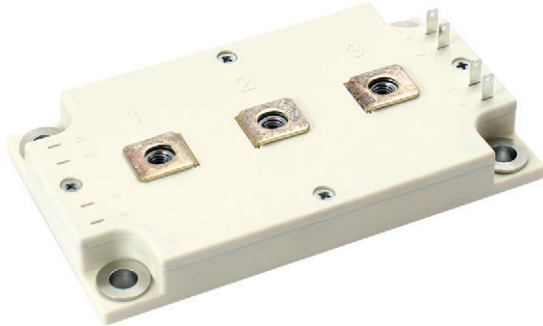

Dual INT-A-PAK Low Profile

FEATURES

- TrenchStop IGBT technology
- Standard: optimized for hard switching speed
- Low $V_{CE(on)}$
- Square RBSOA
- Gen 4 FRED Pt[®] dices technology
- Industry standard package
- Al₂O₃ DBC
- UL approved file E78996
- Designed for industrial level
- Material categorization: for definitions of compliance please see www.vishay.com/doc?99912



RoHS
COMPLIANT

PRIMARY CHARACTERISTICS	
V_{CES}	600 V
I_C DC at $T_C = 114\text{ }^\circ\text{C}$	400 A
$V_{CE(on)}$ (typical) at 400 A, 25 °C	1.14 V
Speed	DC to 1 kHz
Package	Dual INT-A-PAK low profile
Circuit configuration	Half bridge

BENEFITS

- Increased operating efficiency
- Performance optimized as output inverter stage for TIG welding machines
- Direct mounting on heatsink
- Very low junction to case thermal resistance

ABSOLUTE MAXIMUM RATINGS				
PARAMETER	SYMBOL	TEST CONDITIONS	MAX.	UNITS
Collector to emitter voltage	V_{CES}		600	V
Continuous collector current	I_C ⁽¹⁾	$T_C = 25\text{ }^\circ\text{C}$	711	A
		$T_C = 80\text{ }^\circ\text{C}$	532	
Pulsed collector current	I_{CM}	$T_C = 175\text{ }^\circ\text{C}$, $t_p = 6\text{ ms}$, $V_{GE} = 15\text{ V}$	1100	
Clamped inductive load current	I_{LM}		900	
Diode continuous forward current	I_F	$T_C = 25\text{ }^\circ\text{C}$	260	
		$T_C = 80\text{ }^\circ\text{C}$	192	
Gate to emitter voltage	V_{GE}		± 20	V
Maximum power dissipation (IGBT)	P_D	$T_C = 25\text{ }^\circ\text{C}$	1364	W
		$T_C = 80\text{ }^\circ\text{C}$	864	
Maximum power dissipation (Diode)	P_D	$T_C = 25\text{ }^\circ\text{C}$	441	W
		$T_C = 80\text{ }^\circ\text{C}$	279	
RMS isolation voltage	V_{ISOL}	Any terminal to case (V_{RMS} $t = 1\text{ s}$, $T_J = 25\text{ }^\circ\text{C}$)	3500	V

Note

⁽¹⁾ Maximum continuous collector current must be limited to 500 A to do not exceed the maximum temperature of terminals



ELECTRICAL SPECIFICATIONS ($T_J = 25\text{ }^\circ\text{C}$ unless otherwise specified)						
PARAMETER	SYMBOL	TEST CONDITIONS	MIN.	TYP.	MAX.	UNITS
Collector to emitter breakdown voltage	$V_{BR(CES)}$	$V_{GE} = 0\text{ V}, I_C = 1.2\text{ mA}$	600	-	-	V
Collector to emitter voltage	$V_{CE(on)}$	$V_{GE} = 15\text{ V}, I_C = 400\text{ A}$	-	1.14	1.40	
		$V_{GE} = 15\text{ V}, I_C = 400\text{ A}, T_J = 125\text{ }^\circ\text{C}$	-	1.13	-	
Gate threshold voltage	$V_{GE(th)}$	$V_{CE} = V_{GE}, I_C = 6\text{ mA}$	3.8	4.7	6.3	mA
Collector to emitter leakage current	I_{CES}	$V_{GE} = 0\text{ V}, V_{CE} = 600\text{ V}$ $V_{GE} = 0\text{ V}, V_{CE} = 600\text{ V}, T_J = 125\text{ }^\circ\text{C}$	-	0.002	0.3	
Diode forward voltage drop	V_{FM}	$I_{FM} = 400\text{ A}$	-	1.65	2.26	V
		$I_{FM} = 400\text{ A}, T_J = 125\text{ }^\circ\text{C}$	-	1.58	-	
Gate to emitter leakage current	I_{GES}	$V_{GE} = \pm 20\text{ V}$	-	-	± 200	nA

SWITCHING CHARACTERISTICS ($T_J = 25\text{ }^\circ\text{C}$ unless otherwise specified)						
PARAMETER	SYMBOL	TEST CONDITIONS	MIN.	TYP.	MAX.	UNITS
Total gate charge (turn-on)	Q_g	$I_C = 75\text{ A}, V_{CC} = 520\text{ V}, V_{GE} = 15\text{ V}$	-	2791	-	nC
Gate-to-emitter charge (turn-on)	Q_{ge}		-	428	-	
Gate-to-collector charge (turn-on)	Q_{gc}		-	711	-	
Turn-on switching loss	E_{on}	$I_C = 400\text{ A}, V_{CC} = 300\text{ V}, V_{GE} = 15\text{ V}, R_g = 1.5\text{ }\Omega, L = 500\text{ }\mu\text{H}, T_J = 25\text{ }^\circ\text{C}$	-	2.5	-	mJ
Turn-off switching loss	E_{off}		-	20.7	-	
Total switching loss	E_{tot}		-	23.2	-	
Turn-on switching loss	E_{on}		-	2.2	-	
Turn-off switching loss	E_{off}		-	27.6	-	
Total switching loss	E_{tot}		-	29.8	-	
Turn-on delay time	$t_{d(on)}$	$I_C = 400\text{ A}, V_{CC} = 300\text{ V}, V_{GE} = 15\text{ V}, R_g = 1.5\text{ }\Omega, L = 500\text{ }\mu\text{H}, T_J = 125\text{ }^\circ\text{C}$	-	24	-	ns
Rise time	t_r		-	104	-	
Turn-off delay time	$t_{d(off)}$		-	506	-	
Fall time	t_f		-	167	-	
Reverse bias safe operating area	RBSOA	$T_J = 175\text{ }^\circ\text{C}, I_C = 900\text{ A}, V_{CC} = 300\text{ V}, V_p = 600\text{ V}, R_g = 27\text{ }\Omega, V_{GE} = 15\text{ V to } -5\text{ V}, L = 500\text{ }\mu\text{H}$	Fullsquare			
Diode reverse recovery time	t_{rr}	$I_F = 50\text{ A}, di_F/dt = 500\text{ A}/\mu\text{s}, V_{CC} = 200\text{ V}, T_J = 25\text{ }^\circ\text{C}$	-	152	-	ns
Diode peak reverse current	I_{rr}		-	24	-	A
Diode recovery charge	Q_{rr}		-	1.82	-	μC
Diode reverse recovery time	t_{rr}	$I_F = 50\text{ A}, di_F/dt = 500\text{ A}/\mu\text{s}, V_{CC} = 200\text{ V}, T_J = 125\text{ }^\circ\text{C}$	-	200	-	ns
Diode peak reverse current	I_{rr}		-	39	-	A
Diode recovery charge	Q_{rr}		-	3.94	-	μC

THERMAL AND MECHANICAL SPECIFICATIONS						
PARAMETER	SYMBOL	MIN.	TYP.	MAX.	UNITS	
Operating junction and storage temperature range	T_J, T_{Stg}	-40	-	175	$^\circ\text{C}$	
Junction to case per leg	IGBT	-	-	0.11	$^\circ\text{C}/\text{W}$	
	Diode	-	-	0.34		
Case to sink per module	R_{thCS}	-	0.05	-		
Mounting torque	case to heatsink: M6 screw	4	-	6	Nm	
	case to terminal 1, 2, 3: M5 screw	2	-	5		
Weight		-	270	-	g	

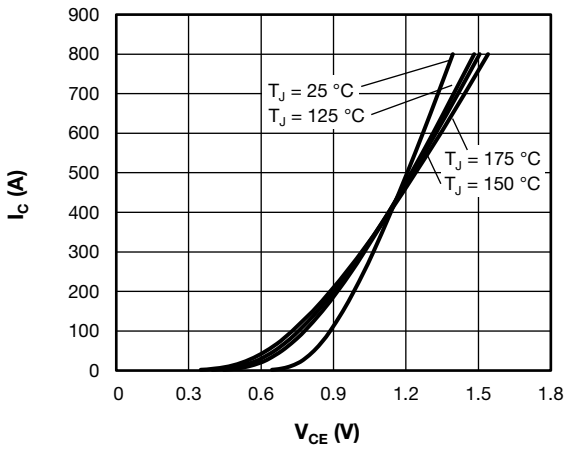

Fig. 1 - Typical Q1 to Q2 IGBT Output Characteristics, $V_{GE} = 15\text{ V}$

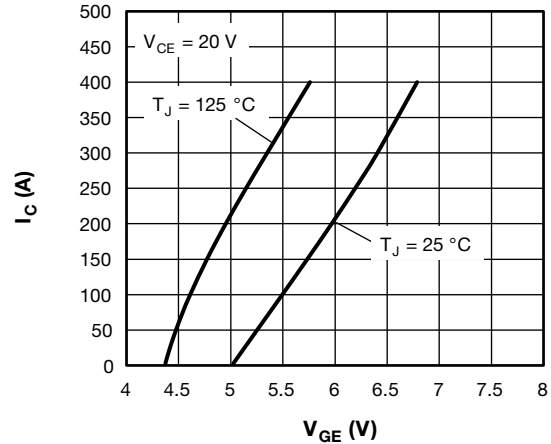

Fig. 4 - Typical Q1 to Q2 IGBT Transfer Characteristics

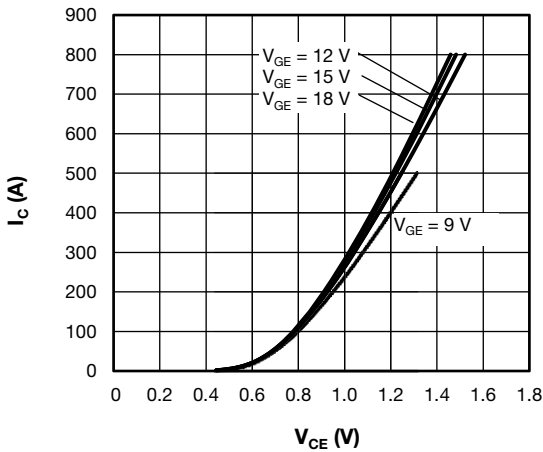

Fig. 2 - Typical Q1 to Q2 IGBT Output Characteristics, $T_J = 125\text{ °C}$

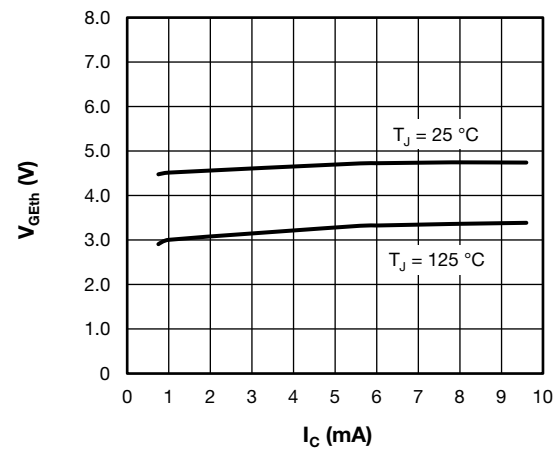

Fig. 5 - Typical Q1 to Q2 IGBT Gate Threshold Voltage

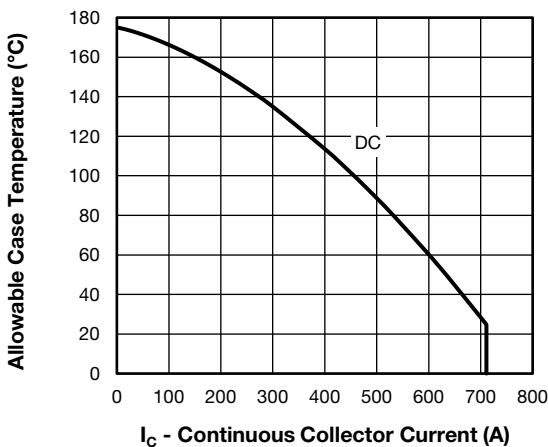

Fig. 3 - Maximum Q1 to Q2 IGBT Continuous Collector Current vs. Case Temperature

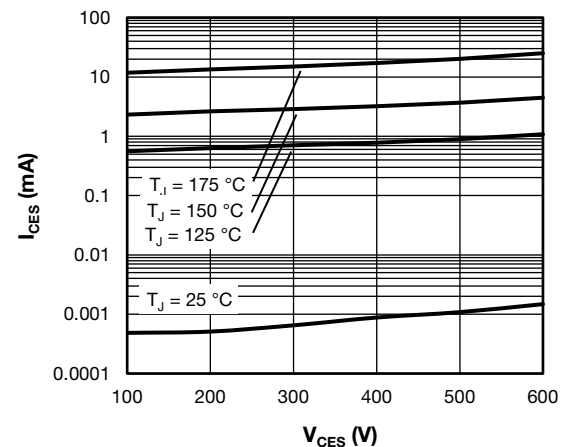

Fig. 6 - Typical Q1 to Q2 IGBT Zero Gate Voltage Collector Current

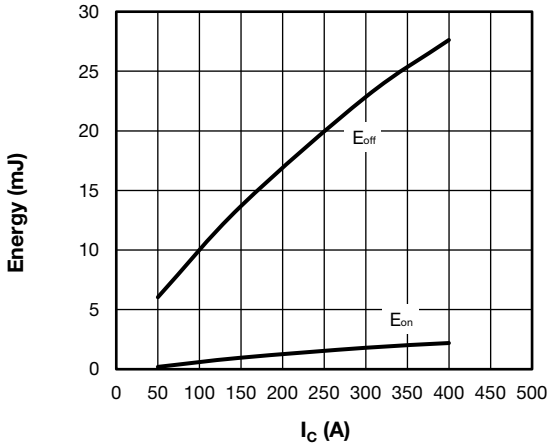

Fig. 7 - Typical Q1 to Q2 IGBT
Energy Loss vs. I_C (with D1 to D2 Antiparallel Diode)
 $T_J = 125^\circ\text{C}$, $V_{CC} = 300\text{ V}$, $R_g = 1.5\ \Omega$, $V_{GE} = +15\text{ V}/-15\text{ V}$, $L = 500\ \mu\text{H}$

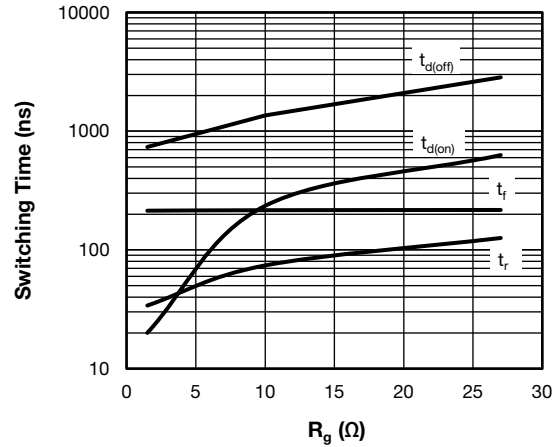

Fig. 10 - Typical Q1 to Q2 IGBT
Switching Time vs. R_g (with D1 to D2 Antiparallel Diode)
 $T_J = 125^\circ\text{C}$, $V_{CC} = 300\text{ V}$, $I_C = 400\text{ A}$, $V_{GE} = +15\text{ V}/-15\text{ V}$, $L = 500\ \mu\text{H}$

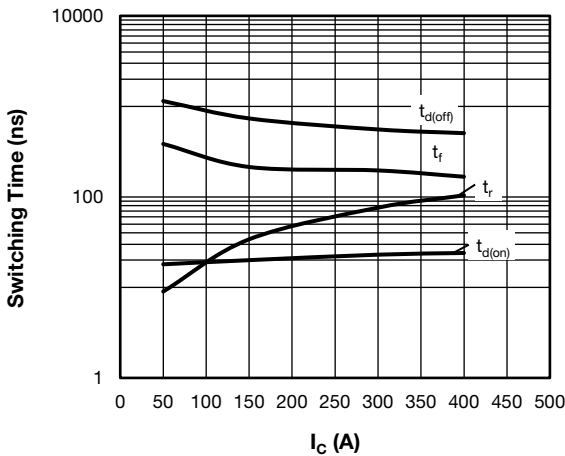

Fig. 8 - Typical Q1 to Q2 IGBT
Switching Time vs. I_C (with D1 to D2 Antiparallel Diode)

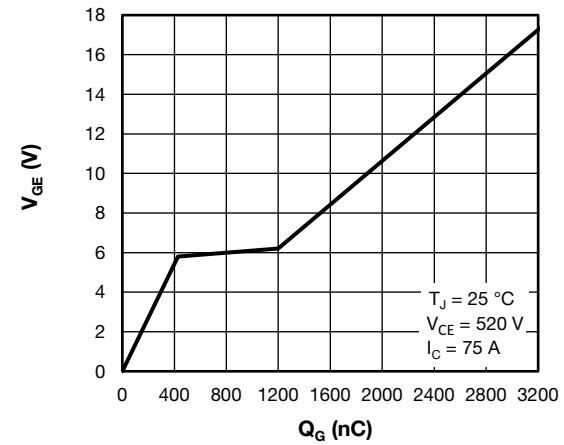

Fig. 11 - Typical Q1 to Q2 IGBT
Gate Charge vs. Gate to Emitter Voltage

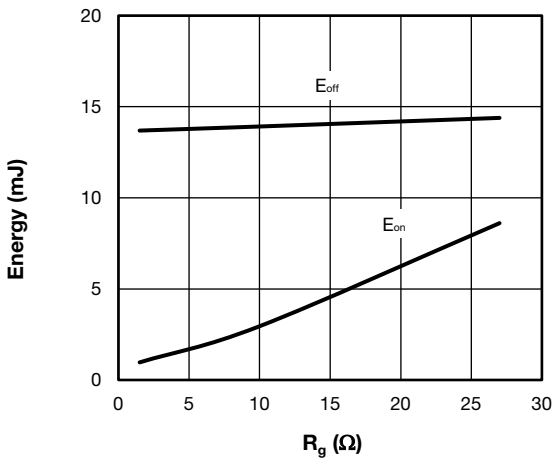

Fig. 9 - Typical Q1 to Q2 IGBT
Energy Loss vs. R_g (with D1 to D2 Antiparallel Diode)

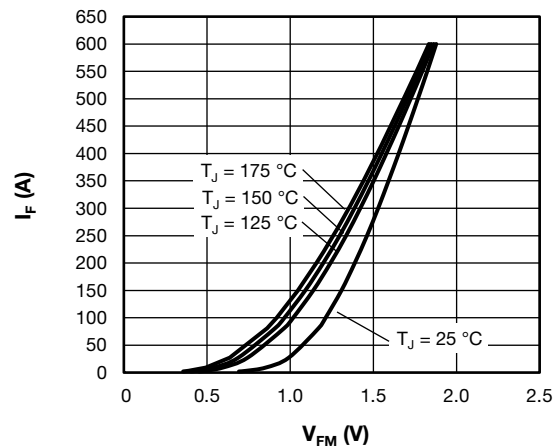

Fig. 12 - Typical D1 to D2 Antiparallel Diode
Forward Characteristics

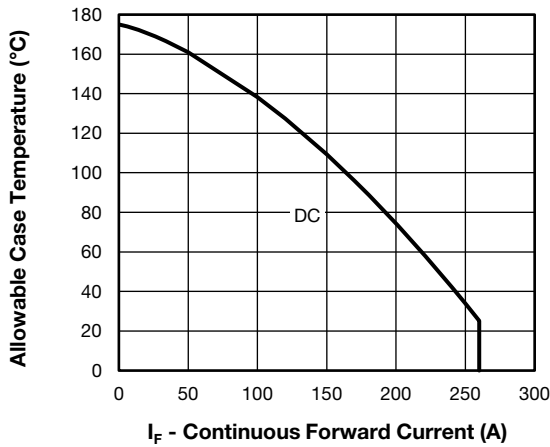

Fig. 13 - Maximum D1 to D2 Antiparallel Diode Continuous Forward Current vs. Case Temperature

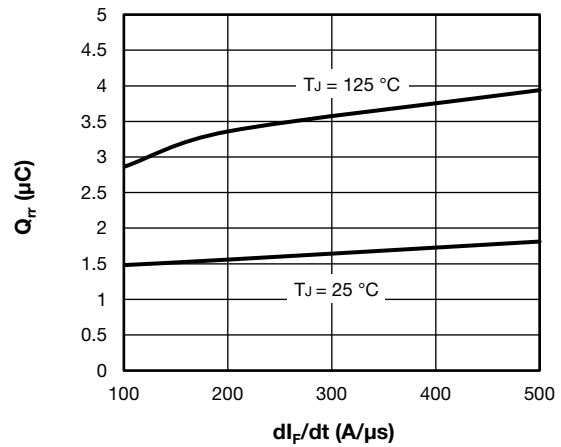

Fig. 16 - Typical D1 to D2 Antiparallel Diode Reverse Recovery Charge vs. di_F/dt , $V_{rr} = 200$ V, $I_F = 50$ A

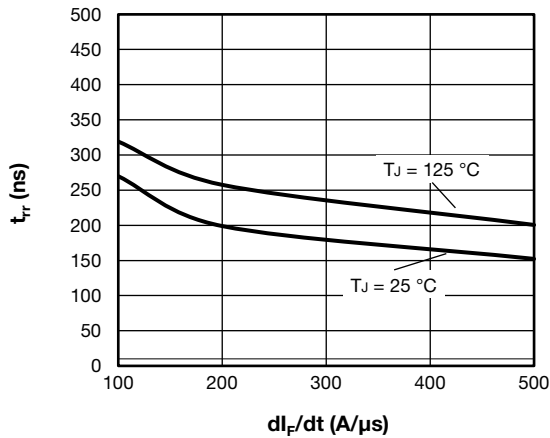

Fig. 14 - Typical D1 to D2 Antiparallel Diode Reverse Recovery Time vs. di_F/dt

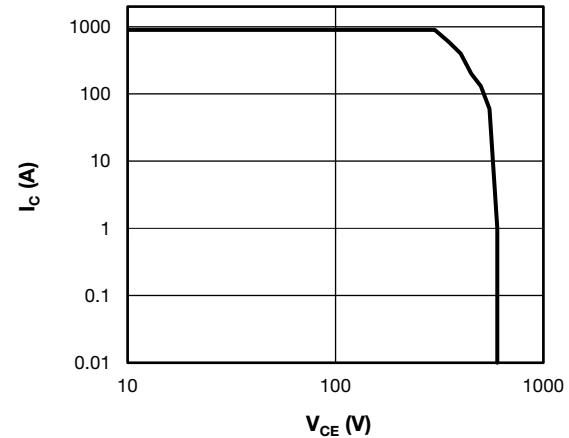

Fig. 17 - Q1 to Q2 IGBT Reverse BIAS SOA
 $T_J = 175$ °C, $I_C = 900$ A, $R_g = 27\Omega$, $V_{GE} = +15$ V / -5 V, $V_{CC} = 300$ V, $V_p = 600$ V

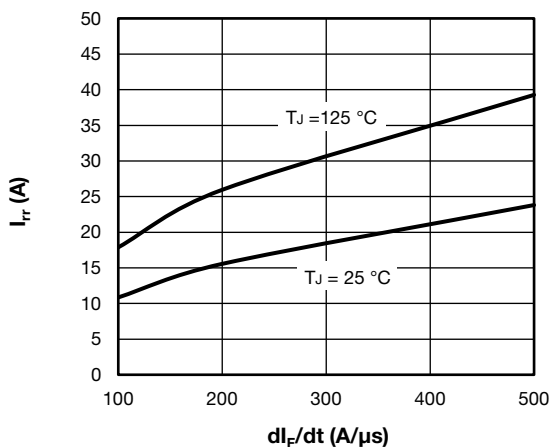

Fig. 15 - Typical D1 to D2 Antiparallel Diode Reverse Recovery Current vs. di_F/dt , $V_{rr} = 200$ V, $I_F = 50$ A

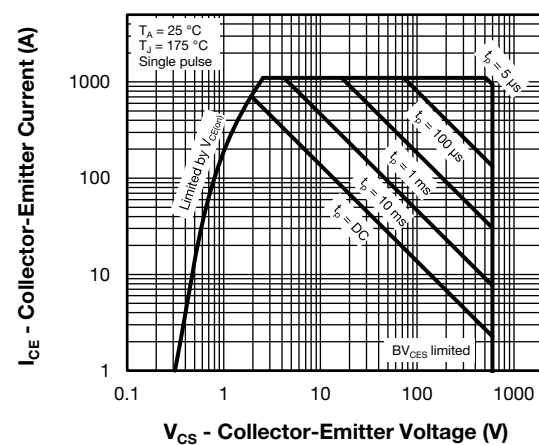

Fig. 18 - Q1 to Q2 IGBT Safe Operating Area

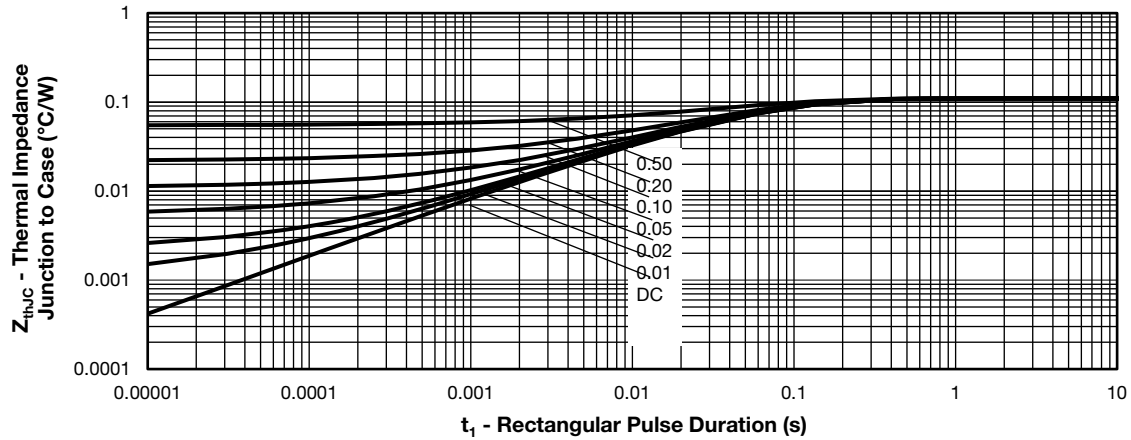

Fig. 19 - Maximum Thermal Impedance Z_{thJC} Characteristics - (Q1 to Q2 IGBT)

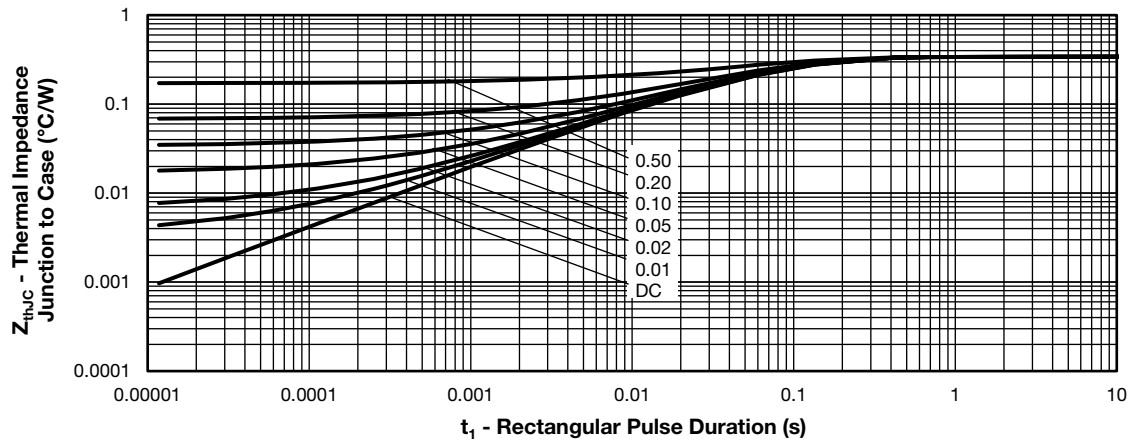

Fig. 20 - Maximum Thermal Impedance Z_{thJC} Characteristics - (D1 to D2 Antiparallel Diode)

ORDERING INFORMATION TABLE

Device code	G	T	400	T	D	60	S
	①	②	③	④	⑤	⑥	⑦
	①	②	③	④	⑤	⑥	⑦
	①	②	③	④	⑤	⑥	⑦
	①	②	③	④	⑤	⑥	⑦
	①	②	③	④	⑤	⑥	⑦
	①	②	③	④	⑤	⑥	⑦
	①	②	③	④	⑤	⑥	⑦

- ① - Insulated gate bipolar transistor (IGBT)
- ② - T = Trench IGBT technology
- ③ - Current rating (400 = 400 A)
- ④ - Circuit configuration (T = half-bridge)
- ⑤ - Package indicator (D = dual INT-A-PAK low profile)
- ⑥ - Voltage rating (60 = 600 V)
- ⑦ - Speed / type (S = standard speed IGBT)



CIRCUIT CONFIGURATION

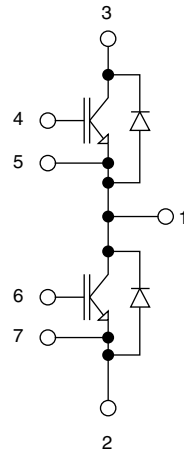

LINKS TO RELATED DOCUMENTS	
Dimensions	www.vishay.com/doc?95435



Dual INT-A-PAK Low Profile

DIMENSIONS in millimeters

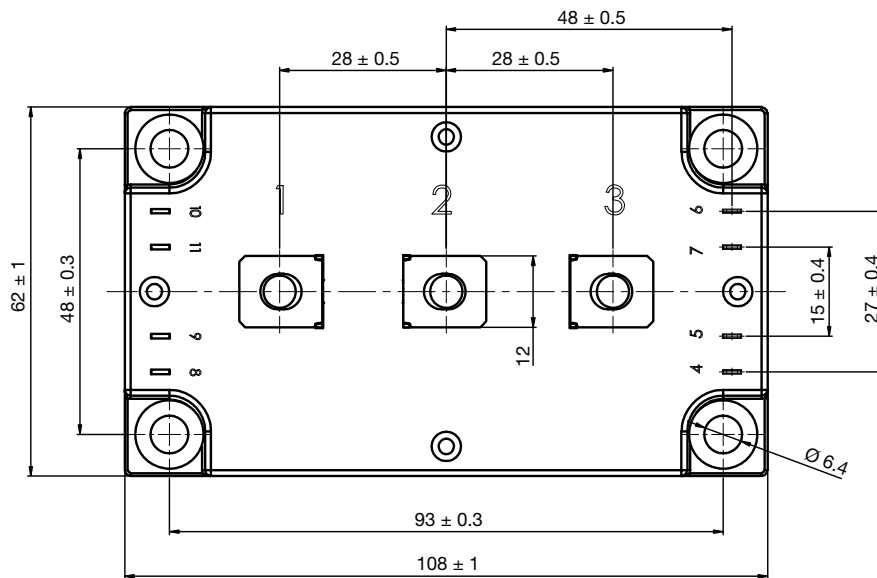
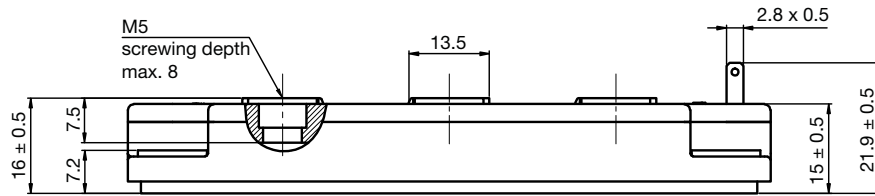



Disclaimer

ALL PRODUCT, PRODUCT SPECIFICATIONS AND DATA ARE SUBJECT TO CHANGE WITHOUT NOTICE TO IMPROVE RELIABILITY, FUNCTION OR DESIGN OR OTHERWISE.

Vishay Intertechnology, Inc., its affiliates, agents, and employees, and all persons acting on its or their behalf (collectively, "Vishay"), disclaim any and all liability for any errors, inaccuracies or incompleteness contained in any datasheet or in any other disclosure relating to any product.

Vishay makes no warranty, representation or guarantee regarding the suitability of the products for any particular purpose or the continuing production of any product. To the maximum extent permitted by applicable law, Vishay disclaims (i) any and all liability arising out of the application or use of any product, (ii) any and all liability, including without limitation special, consequential or incidental damages, and (iii) any and all implied warranties, including warranties of fitness for particular purpose, non-infringement and merchantability.

Statements regarding the suitability of products for certain types of applications are based on Vishay's knowledge of typical requirements that are often placed on Vishay products in generic applications. Such statements are not binding statements about the suitability of products for a particular application. It is the customer's responsibility to validate that a particular product with the properties described in the product specification is suitable for use in a particular application. Parameters provided in datasheets and / or specifications may vary in different applications and performance may vary over time. All operating parameters, including typical parameters, must be validated for each customer application by the customer's technical experts. Product specifications do not expand or otherwise modify Vishay's terms and conditions of purchase, including but not limited to the warranty expressed therein.

Hyperlinks included in this datasheet may direct users to third-party websites. These links are provided as a convenience and for informational purposes only. Inclusion of these hyperlinks does not constitute an endorsement or an approval by Vishay of any of the products, services or opinions of the corporation, organization or individual associated with the third-party website. Vishay disclaims any and all liability and bears no responsibility for the accuracy, legality or content of the third-party website or for that of subsequent links.

Except as expressly indicated in writing, Vishay products are not designed for use in medical, life-saving, or life-sustaining applications or for any other application in which the failure of the Vishay product could result in personal injury or death. Customers using or selling Vishay products not expressly indicated for use in such applications do so at their own risk. Please contact authorized Vishay personnel to obtain written terms and conditions regarding products designed for such applications.

No license, express or implied, by estoppel or otherwise, to any intellectual property rights is granted by this document or by any conduct of Vishay. Product names and markings noted herein may be trademarks of their respective owners.