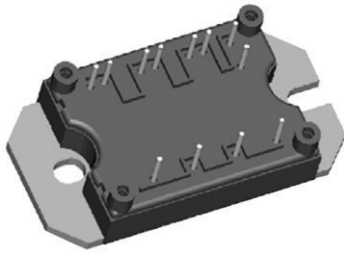

“Half Bridge” IGBT MTP, 121 A

MTP

FEATURES

- Trench IGBT technology
- HEXFRED® antiparallel diodes with ultrasoft reverse recovery
- Very low conduction and switching losses
- Optional SMD thermistor (NTC)
- Very low junction to case thermal resistance
- UL approved file E78996
- Designed and qualified for industrial level
- Material categorization: for definitions of compliance please see www.vishay.com/doc?99912

**RoHS
COMPLIANT**

PRIMARY CHARACTERISTICS	
V_{CES}	600 V
$V_{CE(on)}$ typical at $I_C = 50$ A	1.41 V
I_C at $T_C = 25$ °C	121 A
Speed	30 kHz to 100 kHz
Package	MTP
Circuit configuration	Half bridge

BENEFITS

- Optimized for welding, UPS and SMPS applications
- Low EMI, requires less snubbing
- Direct mounting to heatsink
- PCB solderable terminals
- Very low stray inductance design for high speed operation

ABSOLUTE MAXIMUM RATINGS				
PARAMETER	SYMBOL	TEST CONDITIONS	MAX.	UNITS
Collector to emitter voltage	V_{CES}		600	V
Continuous collector current	I_C	$T_C = 25$ °C	121	A
		$T_C = 117$ °C	50	
Pulsed collector current	I_{CM}	$T_J = 150$ °C, $t_p = 6$ ms, $V_{GE} = 15$ V	250	
Peak switching current	I_{LM}		76	
Diode continuous forward current	I_F	$T_C = 109$ °C	34	
Peak diode forward current	I_{FM}		200	
Gate to emitter voltage	V_{GE}		± 20	V
RMS isolation voltage	V_{ISOL}	Any terminal to case, $t = 1$ min	2500	V
Maximum power dissipation	P_D	$T_C = 25$ °C	305	W
		$T_C = 100$ °C	122	

ELECTRICAL SPECIFICATIONS ($T_J = 25$ °C unless otherwise specified)						
PARAMETER	SYMBOL	TEST CONDITIONS	MIN.	TYP.	MAX.	UNITS
Collector to emitter breakdown voltage	$V_{(BR)CES}$	$V_{GE} = 0$ V, $I_C = 0.4$ mA	600	-	-	V
Collector to emitter voltage	$V_{CE(on)}$	$V_{GE} = 15$ V, $I_C = 50$ A	-	1.41	1.64	V
		$V_{GE} = 15$ V, $I_C = 100$ A	-	1.77	-	
		$V_{GE} = 15$ V, $I_C = 50$ A, $T_J = 150$ °C	-	1.46	-	
Gate threshold voltage	$V_{GE(th)}$	$I_C = 1$ mA	2.9	4.2	5.3	
Collector to emitter leaking current	I_{CES}	$V_{GE} = 0$ V, $I_C = 600$ A	-	0.8	100	µA
		$V_{GE} = 0$ V, $I_C = 600$ A, $T_J = 150$ °C	-	1980	-	
Diode forward voltage drop	V_{FM}	$I_F = 50$ A, $V_{GE} = 0$ V	-	1.58	1.8	V
		$I_F = 50$ A, $V_{GE} = 0$ V, $T_J = 150$ °C	-	1.49	-	
		$I_F = 100$ A, $V_{GE} = 0$ V, $T_J = 25$ °C	-	1.9	-	
Gate to emitter leakage current	I_{GES}	$V_{GE} = \pm 20$ V	-	-	± 250	nA



SWITCHING CHARACTERISTICS (T _J = 25 °C unless otherwise specified)						
PARAMETER	SYMBOL	TEST CONDITIONS	MIN.	TYP.	MAX.	UNITS
Total gate charge (turn-on)	Q _g	I _C = 50 A	-	239	-	nC
Gate to emitter charge (turn-on)	Q _{ge}	V _{CC} = 520 V	-	33	-	
Gate to collector charge (turn-on)	Q _{gc}	V _{GE} = 15 V	-	70	-	
Turn-on switching loss	E _{on}	I _C = 50 A, V _{CC} = 480 V, V _{GE} = 15 V, R _g = 10 Ω, L = 500 μH energy losses include tail and diode reverse recovery, T _J = 25 °C	-	1.09	-	mJ
Turn-off switching loss	E _{off}		-	0.37	-	
Total switching loss	E _{ts}		-	1.46	-	
Turn-on switching loss	E _{on}	I _C = 50 A, V _{CC} = 480 V, V _{GE} = 15 V, R _g = 10 Ω, L = 500 μH energy losses include tail and diode reverse recovery, T _J = 150 °C	-	1.46	-	mJ
Turn-off switching loss	E _{off}		-	0.62	-	
Total switching loss	E _{ts}		-	2.08	-	
Input capacitance	C _{ies}	V _{GE} = 0 V V _{CC} = 25 V f = 1.0 MHz	-	6000	-	pF
Output capacitance	C _{oes}		-	100	-	
Reverse transfer capacitance	C _{res}		-	22	-	
Diode reverse recovery time	t _{rr}	V _{CC} = 200 V, I _C = 50 A di/dt = 200 A/μs	-	82	-	ns
Diode peak reverse current	I _{rr}		-	8.3	-	A
Diode recovery charge	Q _{rr}		-	340	-	nC
Diode reverse recovery time	t _{rr}	V _{CC} = 200 V, I _C = 50 A di/dt = 200 A/μs T _J = 125 °C	-	137	-	ns
Diode peak reverse current	I _{rr}		-	12.7	-	A
Diode recovery charge	Q _{rr}		-	870	-	nC

THERMISTOR SPECIFICATIONS						
PARAMETER	SYMBOL	TEST CONDITIONS	MIN.	TYP.	MAX.	UNITS
Resistance	R ₀ ⁽¹⁾	T ₀ = 25 °C	-	30	-	kΩ
Sensitivity index of the thermistor material	β ⁽¹⁾⁽²⁾	T ₀ = 25 °C T ₁ = 85 °C	-	4000	-	K

Notes

(1) T₀, T₁ are thermistor's temperatures

(2) $\frac{R_0}{R_1} = \exp\left[\beta\left(\frac{1}{T_0} - \frac{1}{T_1}\right)\right]$, temperature in Kelvin

THERMAL AND MECHANICAL SPECIFICATIONS						
PARAMETER	SYMBOL	TEST CONDITIONS	MIN.	TYP.	MAX.	UNITS
Junction and storage temperature range	T _J , T _{Stg}		-40	-	150	°C
Junction to case	R _{thJC}	IGBT	-	-	0.41	°C/W
		Diode	-	-	0.8	
Case to sink per module	R _{thCS}		-	0.06	-	
Clearance ⁽¹⁾		External shortest distance in air between 2 terminals	5.5	-	-	mm
Creepage ⁽¹⁾		Shortest distance along the external surface of the insulating material between 2 terminals	8	-	-	
Mounting torque to heatsink		A mounting compound is recommended and the torque should be checked after 3 hours to allow for the spread of the compound. Lubricated threads.	3 ± 10 %			Nm
Weight			66			g

Note

(1) Standard version only i.e. without optional thermistor

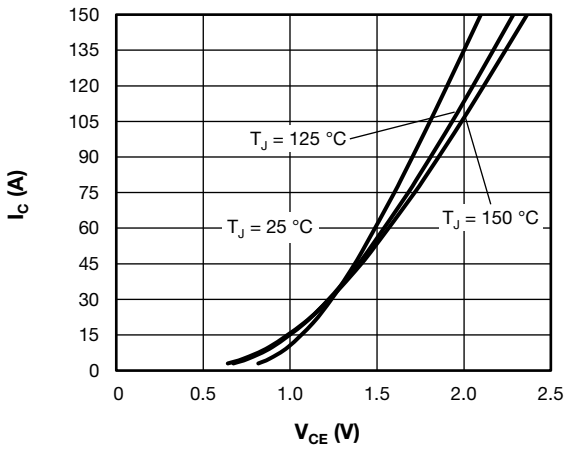

Fig. 1 - Typical Trench IGBT Output Characteristics, $V_{GE} = 15\text{ V}$

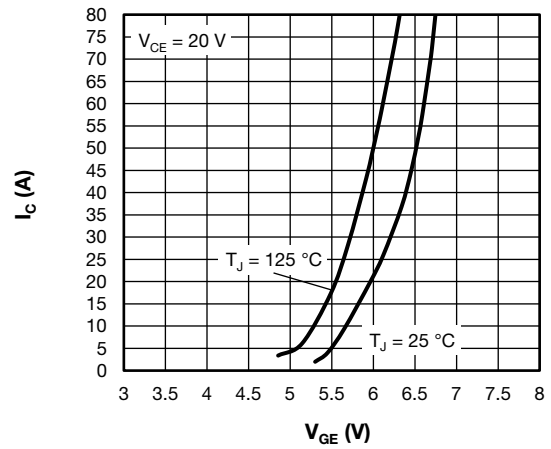

Fig. 4 - Typical Trench IGBT Transfer Characteristics

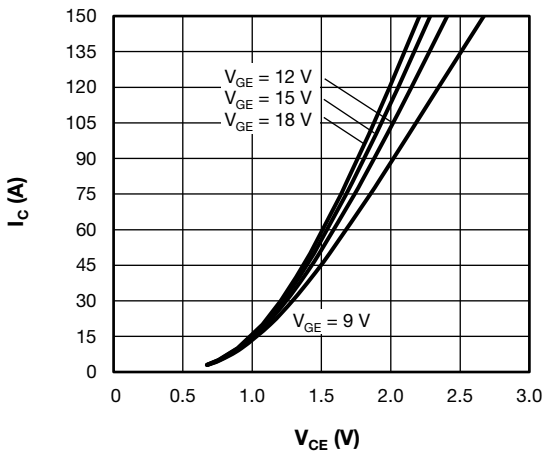

Fig. 2 - Typical Trench IGBT Output Characteristics, $T_J = 125\text{ °C}$

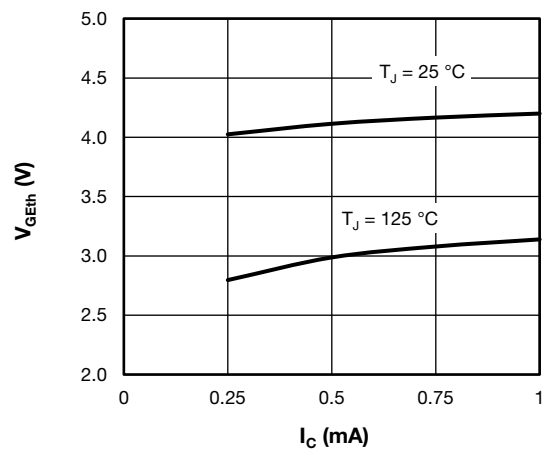

Fig. 5 - Typical Trench IGBT Gate Threshold Voltage

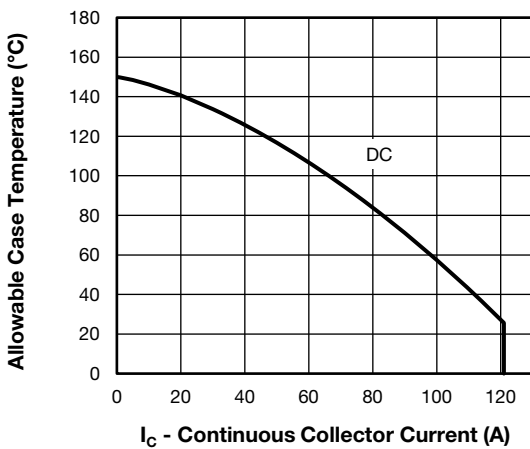

Fig. 3 - Maximum Trench IGBT Continuous Collector Current vs. Case Temperature

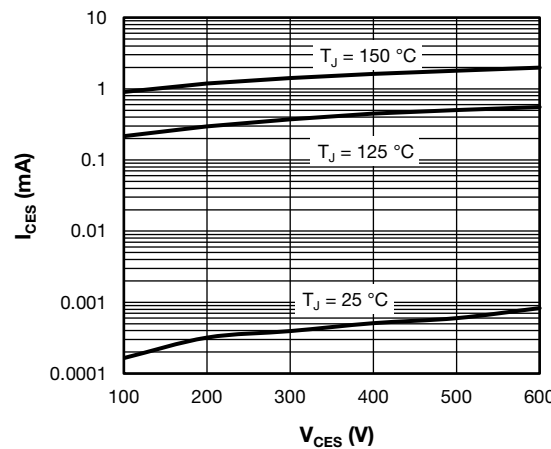

Fig. 6 - Typical Trench IGBT Zero Gate Voltage Collector Current



$T_J = 150\text{ }^\circ\text{C}$, $V_{CC} = 600\text{ V}$, $I_C = 50\text{ A}$, $V_{GE} = +15\text{ V}/-15\text{ V}$, $L = 500\text{ }\mu\text{H}$

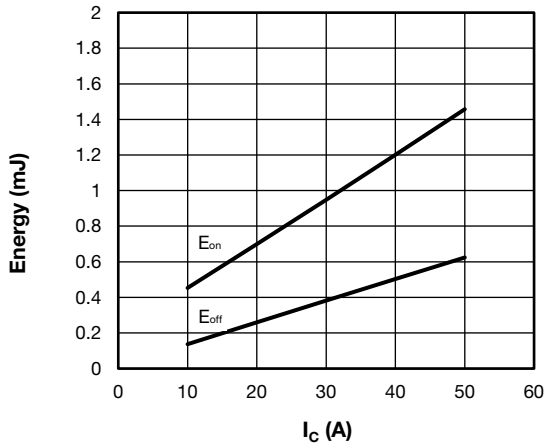

Fig. 7 - Typical Trench IGBT Energy Loss vs. I_C (with Antiparallel Diode)

$T_J = 150\text{ }^\circ\text{C}$, $V_{CC} = 600\text{ V}$, $R_g = 10\text{ }\Omega$, $V_{GE} = +15\text{ V}/-15\text{ V}$, $L = 500\text{ }\mu\text{H}$

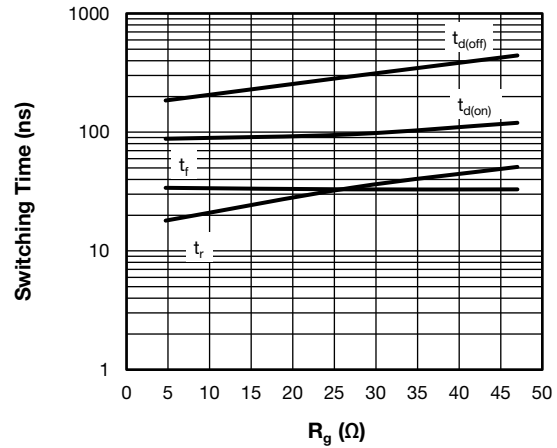

Fig. 10 - Typical Trench IGBT Switching Time vs. R_g (with Antiparallel Diode)

$T_J = 150\text{ }^\circ\text{C}$, $V_{CC} = 600\text{ V}$, $I_C = 50\text{ A}$, $V_{GE} = +15\text{ V}/-15\text{ V}$, $L = 500\text{ }\mu\text{H}$

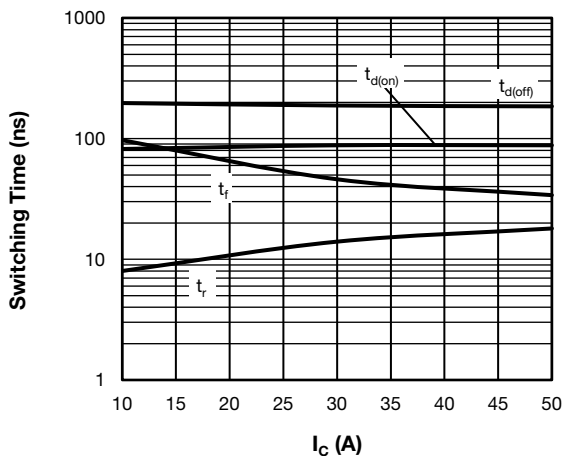

Fig. 8 - Typical Trench IGBT Switching Time vs. I_C (with Antiparallel Diode)

$T_J = 150\text{ }^\circ\text{C}$, $V_{CC} = 300\text{ V}$, $R_g = 10\text{ }\Omega$, $V_{GE} = +15\text{ V}/-15\text{ V}$, $L = 500\text{ }\mu\text{H}$

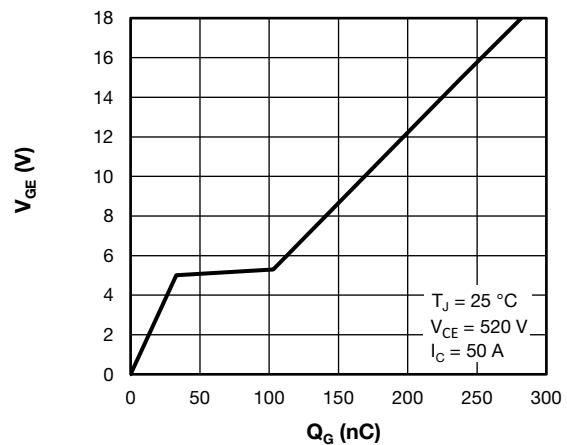

Fig. 11 - Typical Trench IGBT Gate Charge vs. Gate to Emitter Voltage

$T_J = 25\text{ }^\circ\text{C}$
 $V_{CE} = 520\text{ V}$
 $I_C = 50\text{ A}$

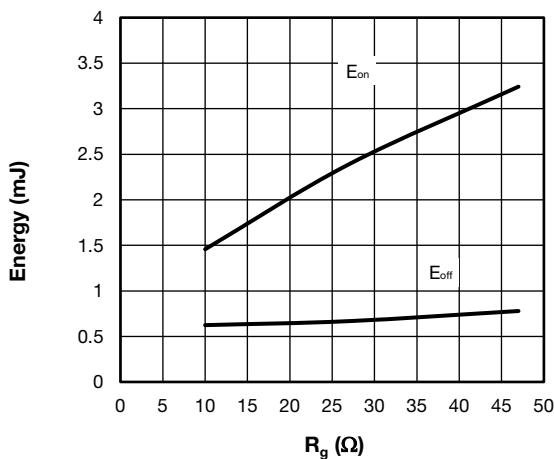

Fig. 9 - Typical Trench IGBT Energy Loss vs. R_g (with Antiparallel Diode)

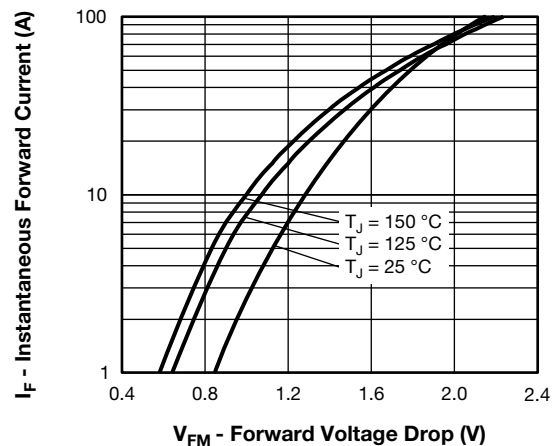

Fig. 12 - Typical Diode Forward Characteristics

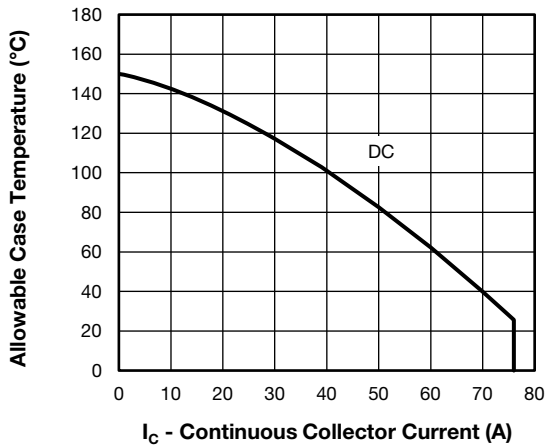

Fig. 13 - Maximum Diode Continuous Collector Current vs. Case Temperature

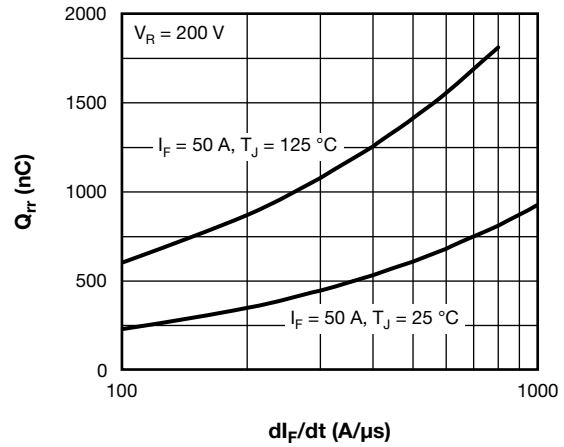

Fig. 16 - Typical Antiparallel Diode Reverse Recovery Charge vs. dI_F/dt

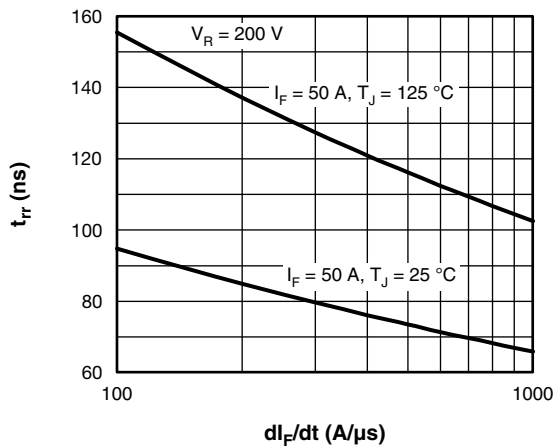

Fig. 14 - Typical Antiparallel Diode Reverse Recovery Time vs. dI_F/dt

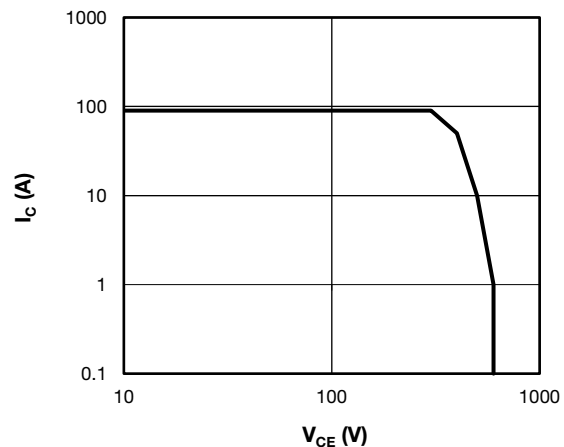

Fig. 17 - Trench IGBT Reverse BIAS SOA
 $T_J = 150\text{ }^\circ\text{C}$, $I_C = 90\text{ A}$, $R_g = 10\text{ }\Omega$, $V_{GE} = +15\text{ V}/0\text{ V}$, $V_{CC} = 300\text{ V}$, $V_p = 600\text{ V}$

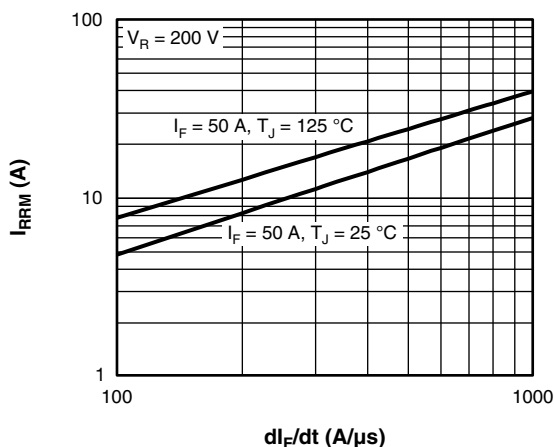

Fig. 15 - Typical Antiparallel Diode Reverse Recovery Current vs. dI_F/dt

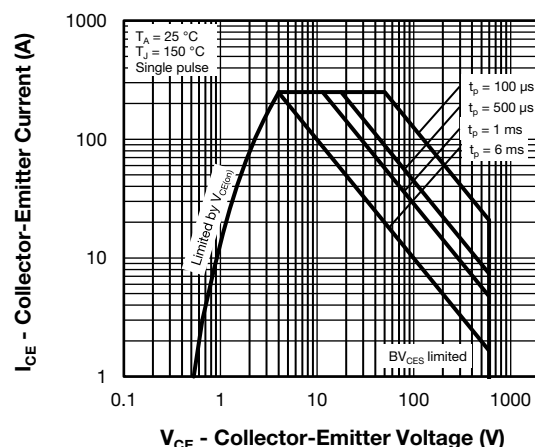

Fig. 18 - Trench IGBT Safe Operating Area

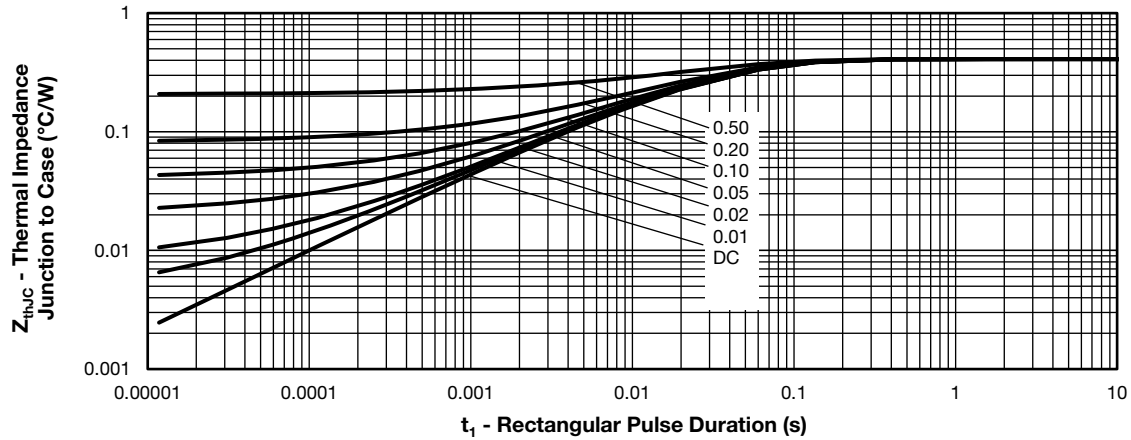

Fig. 19 - Maximum Trench IGBT Thermal Impedance Z_{thJC} Characteristics

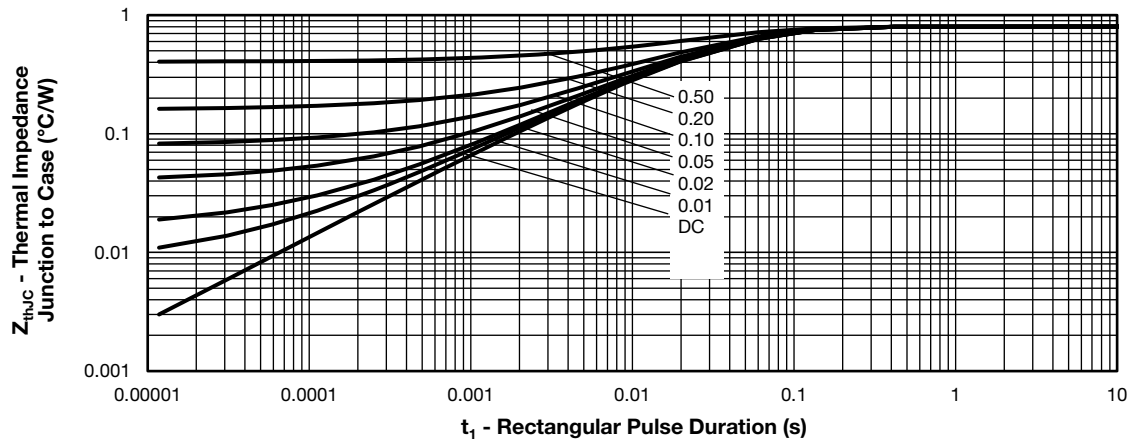

Fig. 20 - Maximum Diode Thermal Impedance Z_{thJC} Characteristics

ORDERING INFORMATION TABLE

Device code	VS-	50	MT	060	P	H	T	A	PbF
	①	②	③	④	⑤	⑥	⑦	⑧	⑨

- 1** - Vishay Semiconductors product
- 2** - Current rating (50 = 50 A)
- 3** - Essential part number
- 4** - Voltage rating (060 = 600 V)
- 5** - Speed / type (P = Trench IGBT)
- 6** - Circuit configuration (H = half bridge)
- 7** - T = thermistor
- 8** - A = Al_2O_3 substrate
- 9** - Lead (Pb)-free



CIRCUIT CONFIGURATION

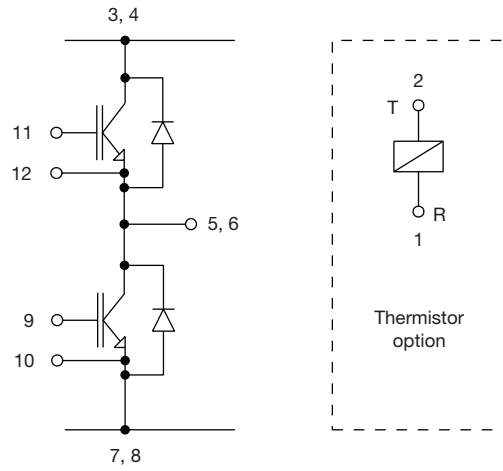

LINKS TO RELATED DOCUMENTS

Dimensions	www.vishay.com/doc?95175
------------	--

MTP

DIMENSIONS in millimeters

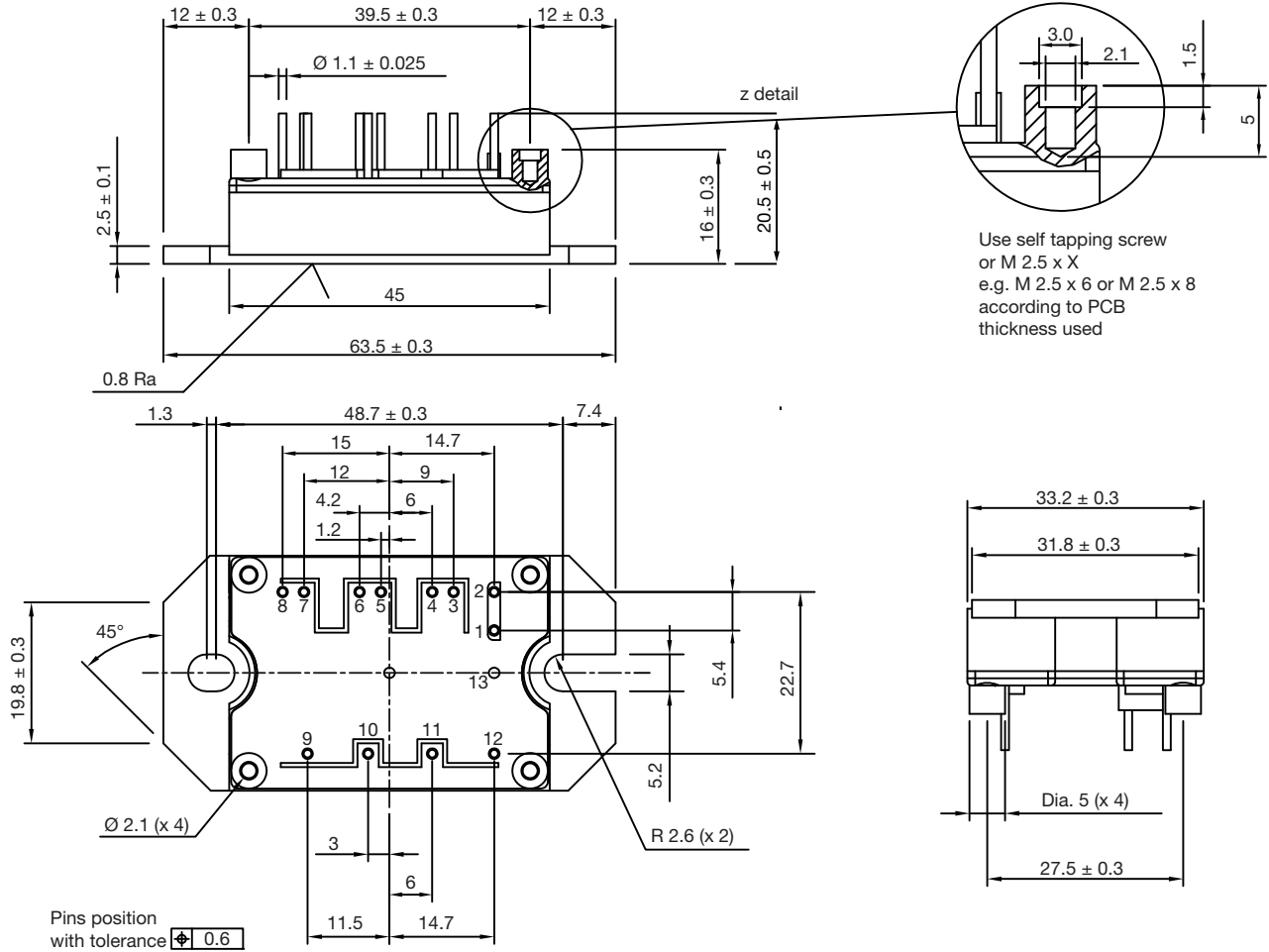

Use self tapping screw or M 2.5 x X e.g. M 2.5 x 6 or M 2.5 x 8 according to PCB thickness used

Note

- Unused terminals are not assembled in the package



Disclaimer

ALL PRODUCT, PRODUCT SPECIFICATIONS AND DATA ARE SUBJECT TO CHANGE WITHOUT NOTICE TO IMPROVE RELIABILITY, FUNCTION OR DESIGN OR OTHERWISE.

Vishay Intertechnology, Inc., its affiliates, agents, and employees, and all persons acting on its or their behalf (collectively, "Vishay"), disclaim any and all liability for any errors, inaccuracies or incompleteness contained in any datasheet or in any other disclosure relating to any product.

Vishay makes no warranty, representation or guarantee regarding the suitability of the products for any particular purpose or the continuing production of any product. To the maximum extent permitted by applicable law, Vishay disclaims (i) any and all liability arising out of the application or use of any product, (ii) any and all liability, including without limitation special, consequential or incidental damages, and (iii) any and all implied warranties, including warranties of fitness for particular purpose, non-infringement and merchantability.

Statements regarding the suitability of products for certain types of applications are based on Vishay's knowledge of typical requirements that are often placed on Vishay products in generic applications. Such statements are not binding statements about the suitability of products for a particular application. It is the customer's responsibility to validate that a particular product with the properties described in the product specification is suitable for use in a particular application. Parameters provided in datasheets and / or specifications may vary in different applications and performance may vary over time. All operating parameters, including typical parameters, must be validated for each customer application by the customer's technical experts. Product specifications do not expand or otherwise modify Vishay's terms and conditions of purchase, including but not limited to the warranty expressed therein.

Hyperlinks included in this datasheet may direct users to third-party websites. These links are provided as a convenience and for informational purposes only. Inclusion of these hyperlinks does not constitute an endorsement or an approval by Vishay of any of the products, services or opinions of the corporation, organization or individual associated with the third-party website. Vishay disclaims any and all liability and bears no responsibility for the accuracy, legality or content of the third-party website or for that of subsequent links.

Except as expressly indicated in writing, Vishay products are not designed for use in medical, life-saving, or life-sustaining applications or for any other application in which the failure of the Vishay product could result in personal injury or death. Customers using or selling Vishay products not expressly indicated for use in such applications do so at their own risk. Please contact authorized Vishay personnel to obtain written terms and conditions regarding products designed for such applications.

No license, express or implied, by estoppel or otherwise, to any intellectual property rights is granted by this document or by any conduct of Vishay. Product names and markings noted herein may be trademarks of their respective owners.