

Agilent U1701B Dual Display Handheld Capacitance Meter

User's and Service Guide



Agilent Technologies

Notices

© Agilent Technologies, Inc. 2009, 2012

No part of this manual may be reproduced in any form or by any means (including electronic storage and retrieval or translation into a foreign language) without prior agreement and written consent from Agilent Technologies, Inc. as governed by United States and international copyright laws.

Manual Part Number

U1701-90055

Edition

Third Edition, June 25, 2012

Printed in Malaysia

Agilent Technologies, Inc.

5301 Stevens Creek Blvd.

Santa Clara, CA 95051 USA

Warranty

The material contained in this document is provided “as is,” and is subject to being changed, without notice, in future editions. Further, to the maximum extent permitted by applicable law, Agilent disclaims all warranties, either express or implied, with regard to this manual and any information contained herein, including but not limited to the implied warranties of merchantability and fitness for a particular purpose. Agilent shall not be liable for errors or for incidental or consequential damages in connection with the furnishing, use, or performance of this document or of any information contained herein. Should Agilent and the user have a separate written agreement with warranty terms covering the material in this document that conflict with these terms, the warranty terms in the separate agreement shall control.

Technology Licenses

The hardware and/or software described in this document are furnished under a license and may be used or copied only in accordance with the terms of such license.

Restricted Rights Legend

U.S. Government Restricted Rights. Software and technical data rights granted to the federal government include only those rights customarily provided to end user customers. Agilent provides this customary commercial license in Software and technical data pursuant to FAR 12.211 (Technical Data) and 12.212 (Computer Software) and, for the Department of Defense, DFARS 252.227-7015 (Technical Data - Commercial Items) and DFARS 227.7202-3 (Rights in Commercial Computer Software or Computer Software Documentation).

Safety Notices

CAUTION

















A **CAUTION** notice denotes a hazard. It calls attention to an operating procedure, practice, or the like that, if not correctly performed or adhered to, could result in damage to the product or loss of important data. Do not proceed beyond a **CAUTION** notice until the indicated conditions are fully understood and met.

WARNING

A **WARNING** notice denotes a hazard. It calls attention to an operating procedure, practice, or the like that, if not correctly performed or adhered to, could result in personal injury or death. Do not proceed beyond a **WARNING** notice until the indicated conditions are fully understood and met.

Safety Symbols

The following symbols on the instrument and in the documentation indicate precautions which must be taken to maintain safe operation of the instrument.

	Direct current		Off (supply)
	Alternating current		On (supply)
	Both direct and alternating current		Equipment protected throughout by double insulation or reinforced insulation.
	Three-phase alternating current		Caution, risk of electric shock.
	Earth (ground) terminal		Caution, risk of danger (refer to this manual for specific Warning or Caution information).
	Protective conductor terminal		Caution, hot surface.
	Frame or chassis terminal		Out position of a bi-stable push control.
	Equipotentiality		In position of a bi-stable push control.

General Safety Information

The following general safety precautions must be observed during all phases of operation, service and repair of this instrument. Failure to comply with these precautions or with specific warnings elsewhere in this manual violates safety standards of design, manufacture and intended use of the instrument. Agilent Technologies assumes no liability for the customer's failure to comply with these requirements.

WARNING

- **Read this operation manual completely before using this device and follow all safety instructions.**
 - **This device is for indoor use at an altitude of up to 2000 m.**
 - **Avoid working alone.**
 - **Use the device only as specified in this manual; otherwise, the protection provided by the meter may be impaired.**
 - **Never measure voltage with this meter.**
 - **Do not use this device if it looks damaged.**
 - **Inspect the leads for damaged insulation or exposed metal. Replace damaged leads.**
 - **Disconnect the power and discharge all high-voltage capacitors before testing.**
 - **Be cautious when working with voltages above 60 V_{DC} or 30 V_{RMS} and 42.4 V_{peak}, as it may cause a shock hazard.**
 - **Always use specified battery.**
 - **The meter is designed in compliance with IEC 61010-1.**
 - **CE requirement: Under the influence of RF field according to standard, the supplied test leads will pick up induced noise. To have better shielding effect, a short-twisted lead should be used.**
-

CAUTION

- Ensure proper insertion of battery in the meter, and follow the correct polarity.
-

Environment Conditions

This instrument is designed for indoor use in areas with low condensation and to be used with standard or compatible test probes. [Table 1-1](#) shows general environment requirements.

Table 1-1 Environment Requirements

Environment Conditions	Requirements
Operating environment	Full accuracy at 0 °C to 50 °C
Operating relative humidity	Full accuracy up to 80% RH for temperature up to 31 °C, decreasing linearly to 50% RH at 50 °C
Storage humidity	0 – 80% R.H. non condensing
Storage environment	–20 °C to 60 °C
Altitude	0 – 2000 m
Pollution Degree	Pollution Degree 2

CAUTION



The U1701B dual display handheld capacitance meter complies with the following safety and EMC requirements:

- IEC 61010-1:2001/EN 61010-1:2001 (2nd Edition)
 - CISPR 11:2003+A1:2004
 - IEC 61000-4-2:1995+A1:1998 +A2:2000
 - IEC 61000-4-3:2006
 - IEC 61000-4-4:2004
 - IEC 61000-4-5:2005
 - IEC 61000-4-6:2003+A1:2004+A2:2006
 - IEC 61000-4-11:2004
 - Canada: ICES/NMB-001:2004
 - Australia/New Zealand: AS/NZS CISPR11:2004
-

CAUTION

Degradation of some product specifications can occur in the presence of ambient electromagnetic (EM) fields and noise that couples to the product's powerline, communication or I/O cables. The product self-recovers and operates to all specifications when the source of the ambient EM field and noise are removed or the product is protected from the ambient EM field or the product cabling is shielded from the ambient EM noise.

Regulatory Markings

	<p>The CE mark is a registered trademark of the European Community. This CE mark shows that the product complies with all the relevant European Legal Directives.</p>		<p>The C-tick mark is a registered trademark of the Spectrum Management Agency of Australia. This signifies compliance with the Australia EMC Framework regulations under the terms of the Radio Communication Act of 1992.</p>
<p>ICES/NMB-001</p>	<p>ICES/NMB-001 indicates that this ISM device complies with Canadian ICES-001.</p>		<p>This instrument complies with the WEEE Directive (2002/96/EC) marking requirement. This affixed product label indicates that you must not discard this electrical/electronic product in domestic household waste.</p>

Waste Electrical and Electronic Equipment (WEEE) Directive 2002/96/EC



This instrument complies with the WEEE Directive (2002/96/EC) marking requirement. This affixed product label indicates that you must not discard this electrical/electronic product in domestic household waste.

Product Category:

With reference to the equipment types in the WEEE directive Annex 1, this instrument is classified as a “Monitoring and Control Instrument” product. The affixed product label is shown as below:

Do not dispose in domestic household waste

To return this unwanted instrument, contact your nearest Agilent office, or visit:

www.agilent.com/environment/product

for more information.

Declaration of Conformity (DoC)

The Declaration of Conformity (DoC) for this instrument is available on the Web site. You can search the DoC by its product model or description.

<http://regulations.corporate.agilent.com/DoC/search.htm>

NOTE

If you are unable to search for the respective DoC, please contact your local Agilent representative.

In This Guide...

- 1 Getting Started** Chapter 1 introduces key features and steps to get started with the U1701B dual display handheld capacitance meter. This chapter also guides you through the basics of the front panel operations.
- 2 Features and Functions** Chapter 2 describes the features and functions that are available in the U1701B dual display handheld capacitance meter in step-by-step instructions.
- 3 Default Setting Configurations** Chapter 3 describes on how to change and configure the default setting of the U1701B dual display handheld capacitance meter and other setting features
- 4 Service and Maintenance** Chapter 4 provides the information on the warranty, services, maintenance procedures and troubleshooting hints to solve general problems that you may encounter with the meter.
- 5 Specifications and Characteristics** Chapter 5 lists U1701B's electrical specifications, general specifications, and SMD Tweezer's specifications.

Contents

1	Getting Started	1
	Introduction	2
	Checking the Shipping Contents	3
	The Front Panel at a Glance	4
	Display Annunciators	5
	The Keypad at a Glance	8
	The Input Terminal at a Glance	9
2	Features and Functions	11
	Static Recording	12
	Data Hold/Trigger Hold	14
	Relative (Zero)	15
	Range Mode	17
	Tolerance Mode	18
	Compare Mode	20
	Setting HI/LO limits	24
	Capacitance Measurement	26
	Communication (Optional Accessories)	28
3	Default Setting Configurations	31
	Power-On Option	32
	Selecting Setup Mode	33
	Setting Factory Default	34
	Setting Baud Rate	35
	Setting Parity Check	36
	Setting Data Bit	37
	Setting Echo	38
	Setting Print Only	39
	Setting Beep Frequency	40

Contents

	Setting Keypad Lock	41
	Setting Auto Power-Off	42
	Setting Backlight Display	44
	Setting Brightness Level of the Backlight for OFF State	45
	Setting Brightness Level of the Backlight for ON State	46
	Reset to Default	47
4	Service and Maintenance	49
	General Maintenance	50
	Battery Replacement	51
	Cleaning	52
	Specification Validation	53
5	Specifications and Characteristics	55
	Electrical Specifications	56
	General Specifications	57
	SMD Tweezers Specifications	58



1 Getting Started

Introduction	2
Checking the Shipping Contents	3
The Front Panel at a Glance	4
Display Annunciators	5
The Keypad at a Glance	8
The Input Terminal at a Glance	9

This chapter introduces the key features and getting started tips of the U1701B dual display handheld capacitance meter. This chapter also guides you through the basics of the front panel operations.



Introduction

This meter is uniquely designed for capacitor sorting. It is a fully auto-ranging 11000 count meter. Manual ranging can be selected via the front push key.

- Auto-range, 11000 count resolution and large LCD with dual display.
- Wide range resolution and measurement from 0.1 pF to 199.99 mF.
- Visible and audible tolerance mode assists you to sort the capacitor.
- Comparison mode with 25 sets for High/Low limit setting, including the non-volatile memory available in the U1701B. This will save your settings even when the meter is powered off.
- Static recording captures stable values for maximum, average and minimum without using a calculator.
- Relative mode will help you to calculate the difference between a standard and a measuring value.
- Data hold with manual or auto trigger
- Bi-directional optic computer interface with available software application will assist you to a specialist and make report easier.
- Low battery indication
- Bright LED backlight
- Safe, precise, and speed closed case calibration

Checking the Shipping Contents

Inspect and verify that you have received the following items for the standard purchase of the U1701B and/or optional accessories that you may have ordered. If any of the item listed below is missing, contact your nearest Agilent Technologies Sales Office.

Table 1-1 List of standard and optional accessories

Type	Part Number	Accessories
Standard		Agilent U1701B Quick Start Guide
		Alligator clip leads
		9 V Alkaline battery
		Certificate of Calibration (CoC)
Optional	U5481A	IR to USB cable
	U1780A	Power adaptor
	U1782A	SMD Tweezers
	U1174A	Soft carrying case

The Front Panel at a Glance

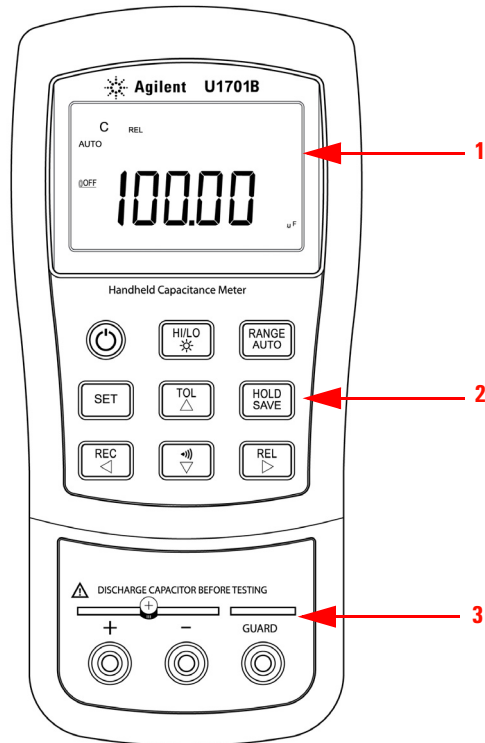



Figure 1-1 Front panel of U1701B dual display handheld capacitance meter

No.	Panels
1	Annunciator display
2	Keypad
3	Input terminals

Display Annunciators

To view the full display, press and hold  then press  to power-on the meter. Press any key to resume to normal functionality mode.

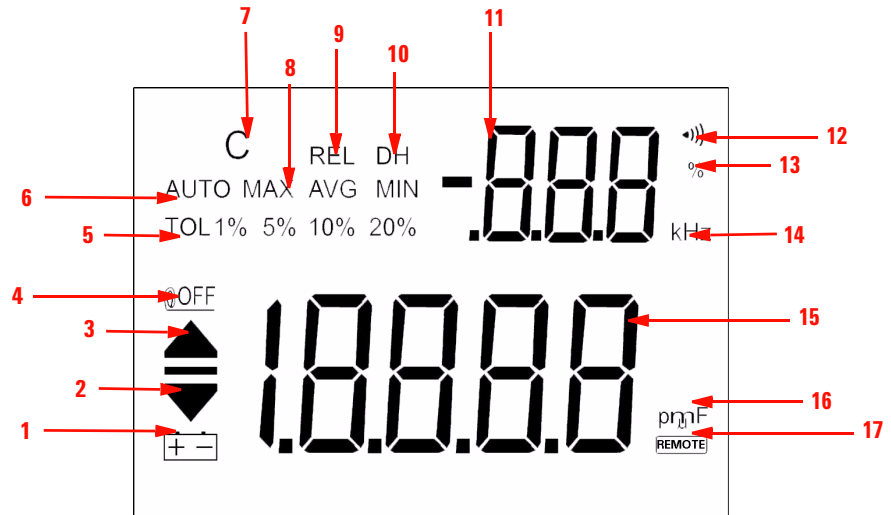











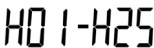

Figure 1-2 Annunciator display of a U1701B dual display handheld capacitance meter

Table 1-2 Descriptions of each annunciator

No.	Symbols	Descriptions
1		Low battery indicator
2		Reading out of the LO limit
3		Reading out of the HI limit
4		Auto power-off indicator
5	TOL 1% 5% 10% 20%	Tolerance mode, to set 1%, 5%, 10% and 20% for sorting capacitance.
6	AUTO	AUTO range
7	C	Charging period will be flashed, display as discharging period
8	MAX AVG MIN	Static recording mode MAX: Maximum reading AVG: Average reading MIN: Minimum reading
9	REL	Relative mode
10	DH	Data hold to hold the displayed digital value (DH flashing means under trigger)
11		Secondary display
12		Audible alert for tolerance or compare mode
13	%	Unit for tolerance display.
14	kHz	Unit for Beeper Frequency as setup mode
15		Primary display

16		Capacitance unit pF: 1/1000,000,000,000 F nF: 1/1000,000,000 F F: 1/1000,000 F mF: 1/1000 F
17		Remote control

Special Indication Characters

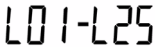
	Descriptions		Descriptions
	Reading out of the HI/LO limits		The primary display shows HI limit setting
	Reading within the HI/LO limits		The primary display shows LO limit setting

The Keypad at a Glance

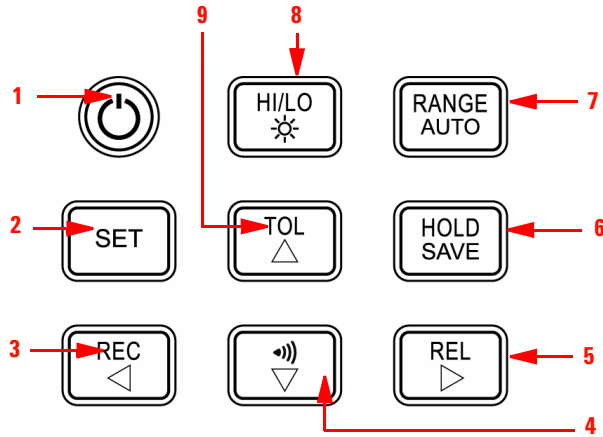



Figure 1-3 Keypad of a U1701B dual display handheld capacitance meter

Table 1-3 Keypad descriptions and functions

No.	Keys	Functions
1	Power	To turn ON/OFF the instrument
2	SET	Set high/low limits for compare mode
3	REC	Static recording mode
4		Compare mode
5	REL	Relative mode
6	HOLD SAVE	Data hold To store the setting value into the memory
7	RANGE AUTO	Manual range Auto range
8	HI/LO 	High/Low limits Backlight display
9	TOL	Tolerance mode

The Input Terminal at a Glance

WARNING

To avoid damaging this device, discharge the capacitor before testing. Be sure the polarity for capacitance measurement.

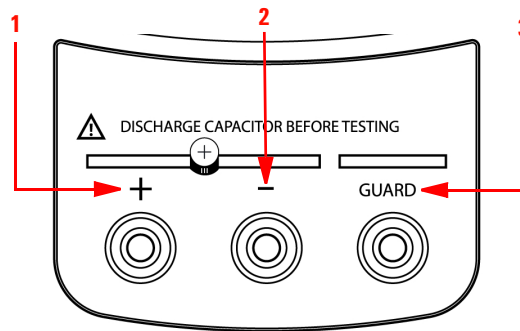

Figure 1-4 Input terminals/sockets of U1701B dual display handheld capacitance meter

No.	Terminals	Functions
1	+	Positive terminal/ socket
2	-	Negative terminal/ socket
3	GUARD	Guard terminal/ socket

1 Getting Started



Features and Functions

Static Recording	12
Data Hold/Trigger Hold	14
Relative (Zero)	15
Range Mode	17
Tolerance Mode	18
Compare Mode	20
Setting HI/LO limits	24
Capacitance Measurement	26
Communication (Optional Accessories)	28

This chapters provides detailed information on the features and functions that are available in the U1701B.



Static Recording

The static recording mode can record the maximum capacitance and minimum capacitance you measured. Furthermore it is able to perform averaging on the measurement result. Static recording captures only stable values and updates the memory; the meter will not record values that are **OL** (overload) or below 10 counts.

The operational procedures are described below:

- 1** Press **REC** key momentarily to enter the static recording. The present value is stored to memories of maximum, minimum and average. The **MAX**, **AVG**, **MIN** annunciator will be lit.
- 2** Press this key momentarily to cycle through maximum, minimum, average and present readings. The **MAX**, **MIN**, **AVG** or **MAX AVG MIN** annunciator turns on respectively to indicate which value is being displayed (see [Figure 2-1](#)).
- 3** The beeper will beep once when a new **MAX** or **MIN** value has been recorded.
- 4** Selecting static recording mode as auto range, it will record the value of **MAX**, **MIN** or **AVG** for different ranges.
- 5** Press **REC** key for more than 1 s to exit recording mode.
- 6** The auto power-off feature will be disabled and the **@OFF** will be turned off as recording mode.

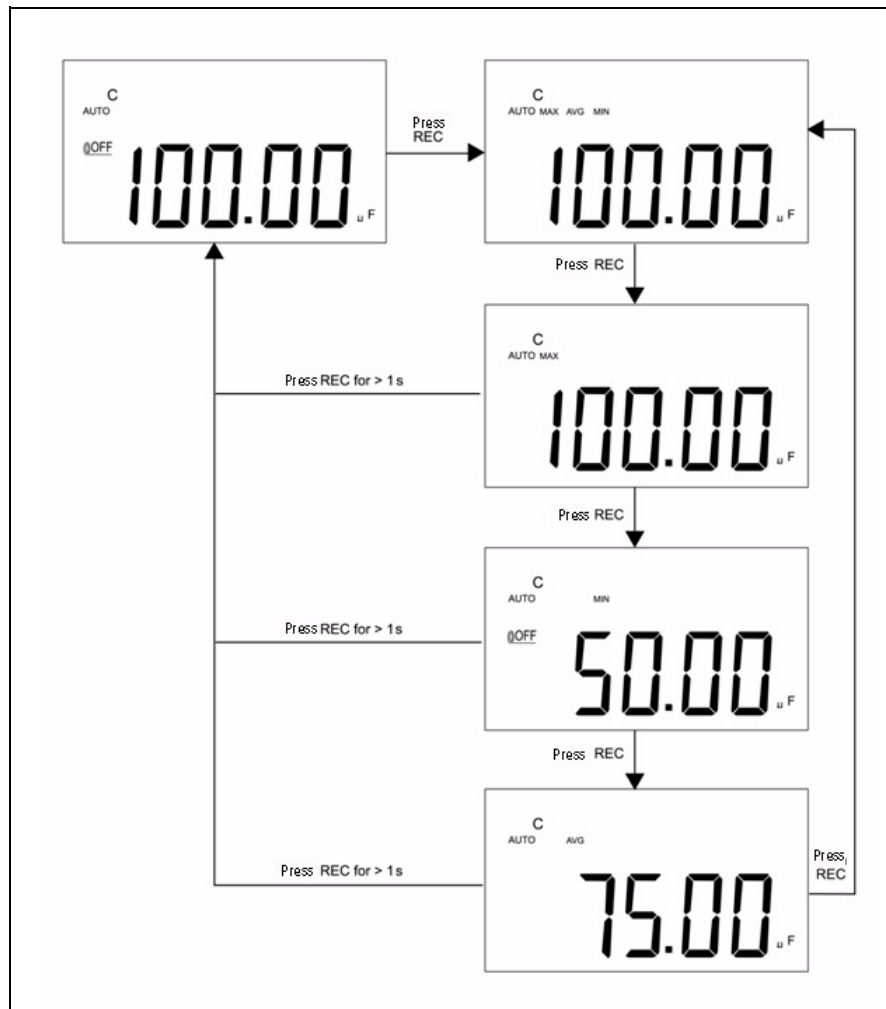

Figure 2-1 Tolerance operation

Data Hold/Trigger Hold

The data hold function allows the users to hold the displayed digital value. Refer to the following procedures to enable data hold:

- 1 Press **HOLD** key to freeze the displayed value and enter manual trigger mode, and the sign of **DH** will be displayed.
- 2 Press **HOLD** key again to trigger another new measuring value updated to display. The sign of **DH** will be flashed before the new updates.
- 3 Press **HOLD** key for more than 1 s to exit this mode.

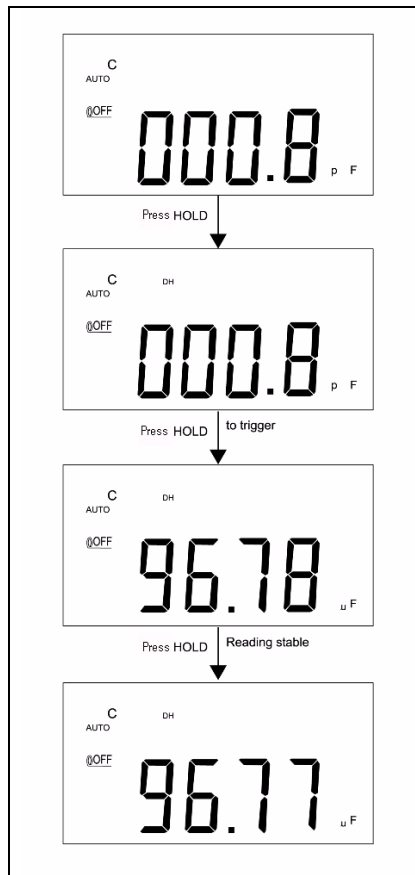

Figure 2-2 Data/Trigger Hold operation

Relative (Zero)

The relative function subtracts a stored value from the present measurement and displays the result on the meter.

- 1** Press **REL** key momentarily to set the relative mode. This will set the display to zero and store the displayed reading as a reference value. The **REL** annunciator will be displayed.
- 2** The relative mode can be set at auto or manual range, but not when an overload has occurred.
- 3** Press **REL** key momentarily to set the relative mode again.
- 4** With small capacitance measurement, the display will show a non-zero value due to the presence of alligator clip leads. Use the relative function to Zero-Adjust the display.
- 5** Press and hold **REL** key for more than 1 s to quit relative mode.

2 Features and Functions

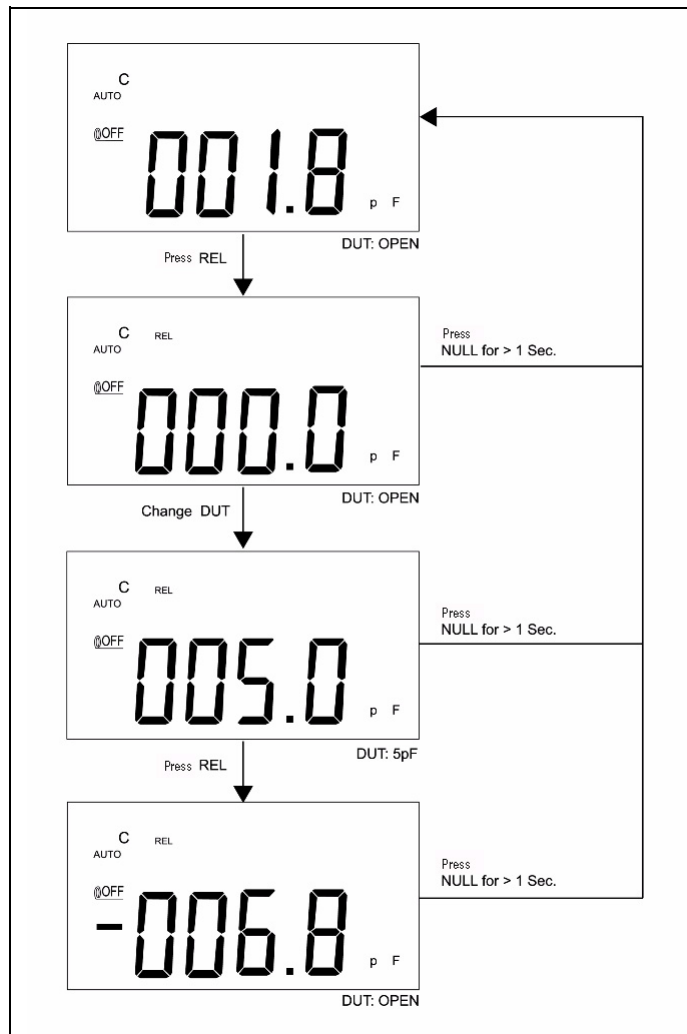

Figure 2-3 Relative (Zero) operation

Range Mode

To set auto or manual range, refer to the procedures below:

- 1** Press **RANGE** key to select manual range and turn off the **AUTO** annunciator.
- 2** Press **RANGE** key once to step up a range at a time.
- 3** In auto-range, the **AUTO** annunciator is displayed and the meter will select an appropriate range for resolution if a reading is greater than maximum available range, **OL** (overload) will be displayed. The meter will select a lower range when reading is less than about 9% of full scale.
- 4** Press **RANGE** key for more than 1 s to select auto-range.

Tolerance Mode

The tolerance mode has **1%**, **5%**, **10%**, and **20%** tolerance ranges. To enter the tolerance mode, insert a standard value into the socket. Press the **TOL** key to set the display value as the standard reference. Similarly, the DH value which appears on the primary display can be used as a standard value to sort the components. Press **TOL** key again to cycle through **1%**, **5%**, **10%** and **20%** tolerance and select the desired tolerance. The meter range locks as tolerance mode.

This mode can not be set under following condition:

- After setting the recording mode.
- After setting HI/LO Audible Alert mode.
- The tested display is either **OL** or below 10 count.

This function is designed for sorting the values. The beeper will beep three times when the reading is out of the selected tolerance. A single beep represents that the reading is within the selected tolerance.

NOTE

To exit tolerance mode, press and hold **TOL** key for more than 1 s

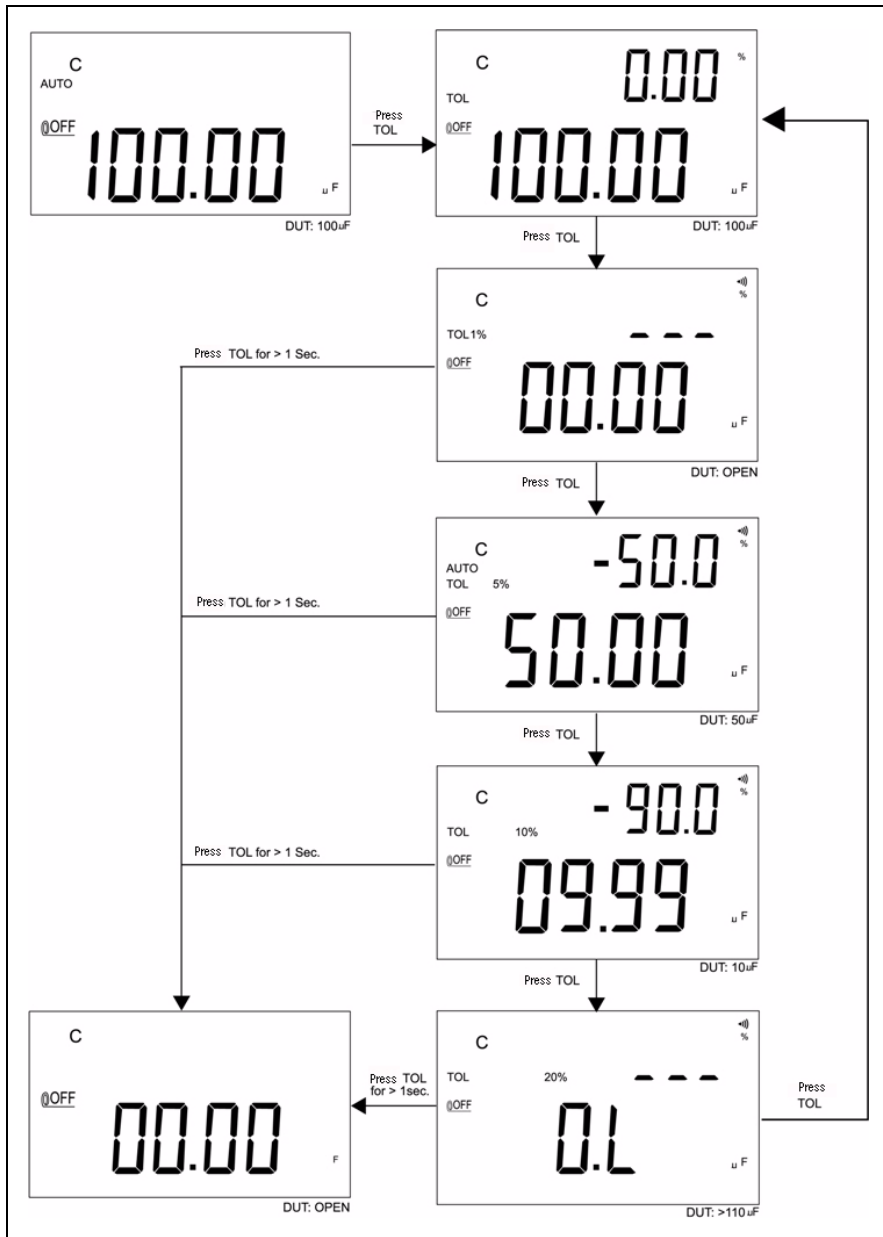

Figure 2-4 Tolerance operation

Compare Mode

The compare mode allows you to sort out the capacitors, and you can set up to 25 sets of limit ranges. This meter has initial set for High and Low limits, see below table:

No	High limit	Low Limit
1	100	90
2	120	108
3	150	135
4	180	162
5	220	198
6	270	243
7	330	297
8	390	351
9	470	423
10	560	504
11	680	612
12	820	738
13	1000	900
14	1200	1080
15	1500	1350
16	1800	1620
17	2200	1980
18	2700	2430
19	3300	2970
20	3900	3510
21	4700	4230
22	5600	5040
23	6800	6120
24	8200	7380
25	10000	9000

These initial sets can be modified, please refer to the “[Setting HI/LO limits](#)” for detailed description. Besides that, the power-on option can be used to restore the default factory settings.

The following procedures will guide you on how to set compare mode:

- 1 Press  key momentarily to enter HI/LO Audible Alert mode.

The meter locks range in this mode. The  annunciator will be indicated, and the secondary display will indicate **C01** to **C25** or the previously saved set during last operation. The first left digit means comparison mode. The last two digits indicate current comparison set. The primary display will indicate the present measurement. The meter is ready to test.

- 2 Press  key momentarily to select different sets. The secondary display will indicate **C01** to **C25** according to which comparison set has been selected. Press and hold **SAVE** key for more than 1 s to save comparison set for next entry.
- 3 Press **HI/LO** key to cycle through the HI/LO value used for comparison and back to ready mode. The HI/LO limits will be briefly indicated on the primary display, and then back to the ready mode.
- 4 If the reading is out of the HI/LO limits, the beeper will beep three times and the secondary display will indicate **nGo**. If the reading is within the HI/LO limits, the beeper will beep once and the secondary display will indicate **Go**. After 3 s, the meter will return to ready state.

- 5 Press and hold the  key for more than 1 s to exit audible alert mode.

2 Features and Functions

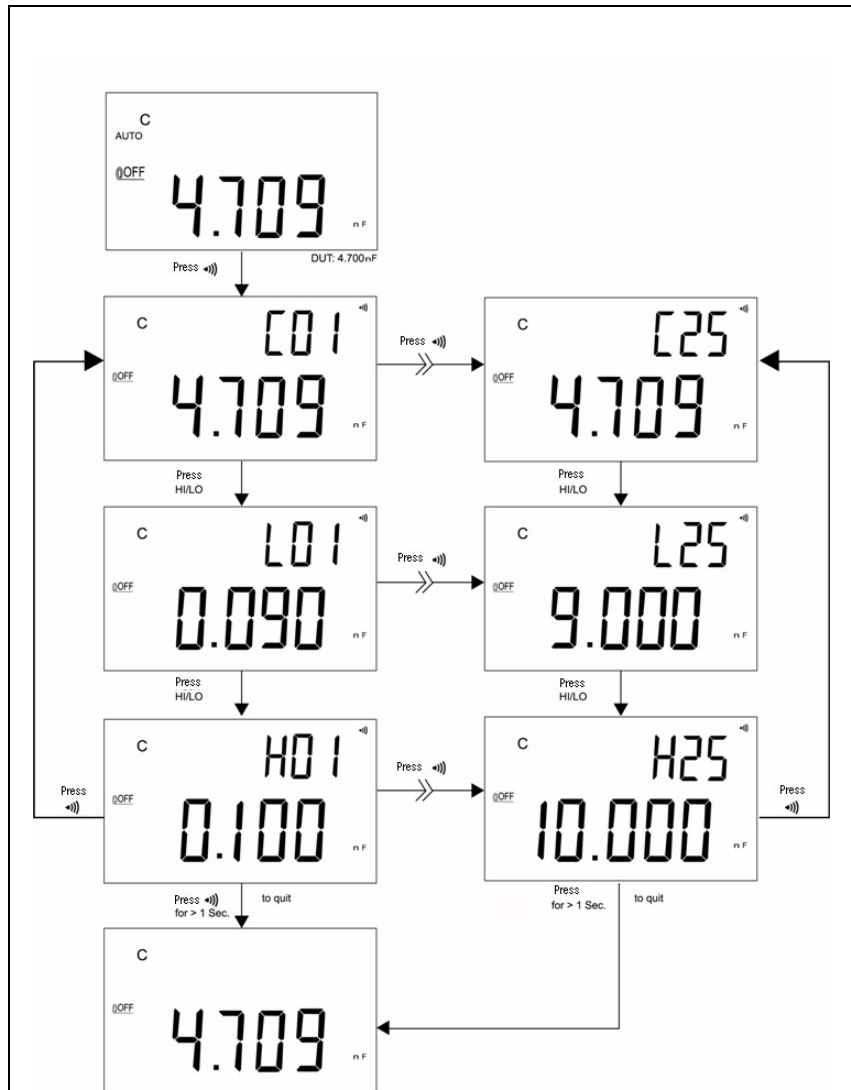

Figure 2-5 Set compare mode

Figure 2-6 shows you the display by compare mode for sorting:

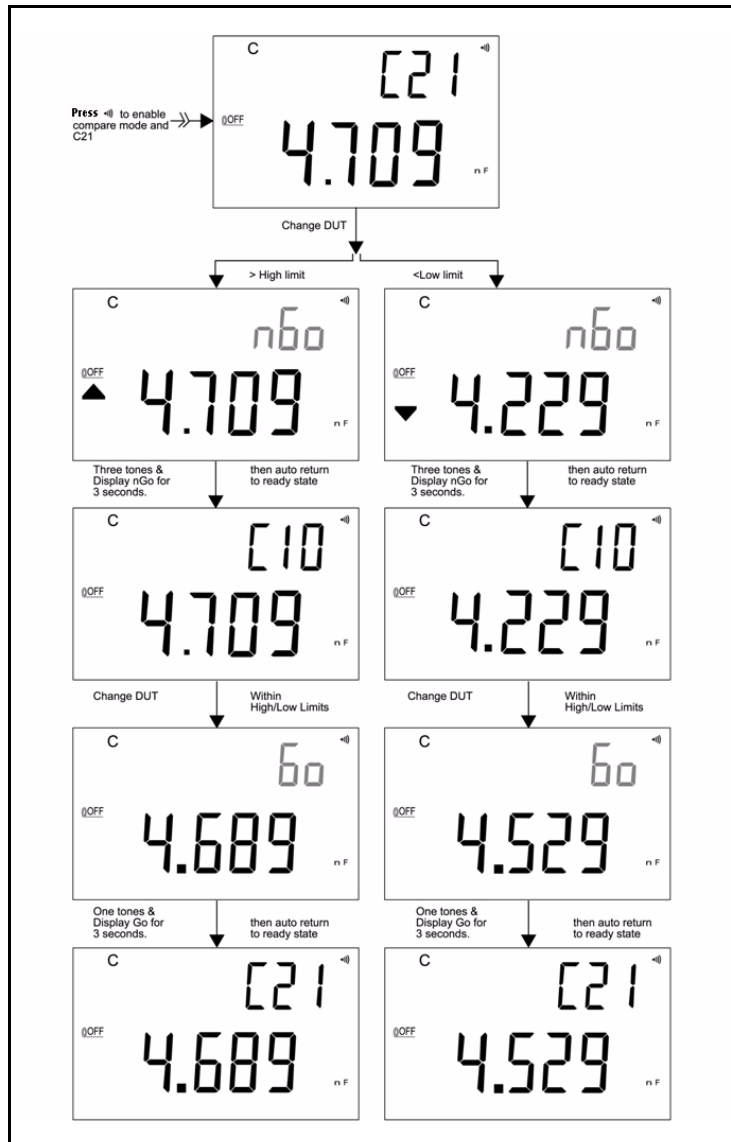

Figure 2-6 Sorting by compare mode

Setting HI/LO limits

To set the HIGH and LOW limits for compare mode, refer to the following procedures:

- 1 Press and hold **SET** key for more than 1 s to enable the HI/LO limit setting mode.
- 2 The secondary display will flash **L01** and the primary display will indicate the limit value. The following keys will be used for this setting mode:
 - a \triangleleft (Left) or \triangleright (Right): select which digit to be adjusted.
 - b \triangle (Up) or ∇ (Down): to Increase or decrease the current digit value.
 - c **HI/LO**: Select High or Low limit to be set.
 - d **SAVE**: Press this key for more than 1 second to store the setting value into the memory. The beeper will beep twice, meaning the selected value has been stored. If the current setting does not meet the rule that the HI limit must be equal or greater than the LO limit, the beeper will beep three times.
- 3 **SET**: Select next compare setting. Press this key momentarily to cycle through #01 to #25 then return to #01 setting according to Hi/LO limit.
- 4 Press and hold the **SET** key for more than 1 second to exit the HI/LO limit setting mode.

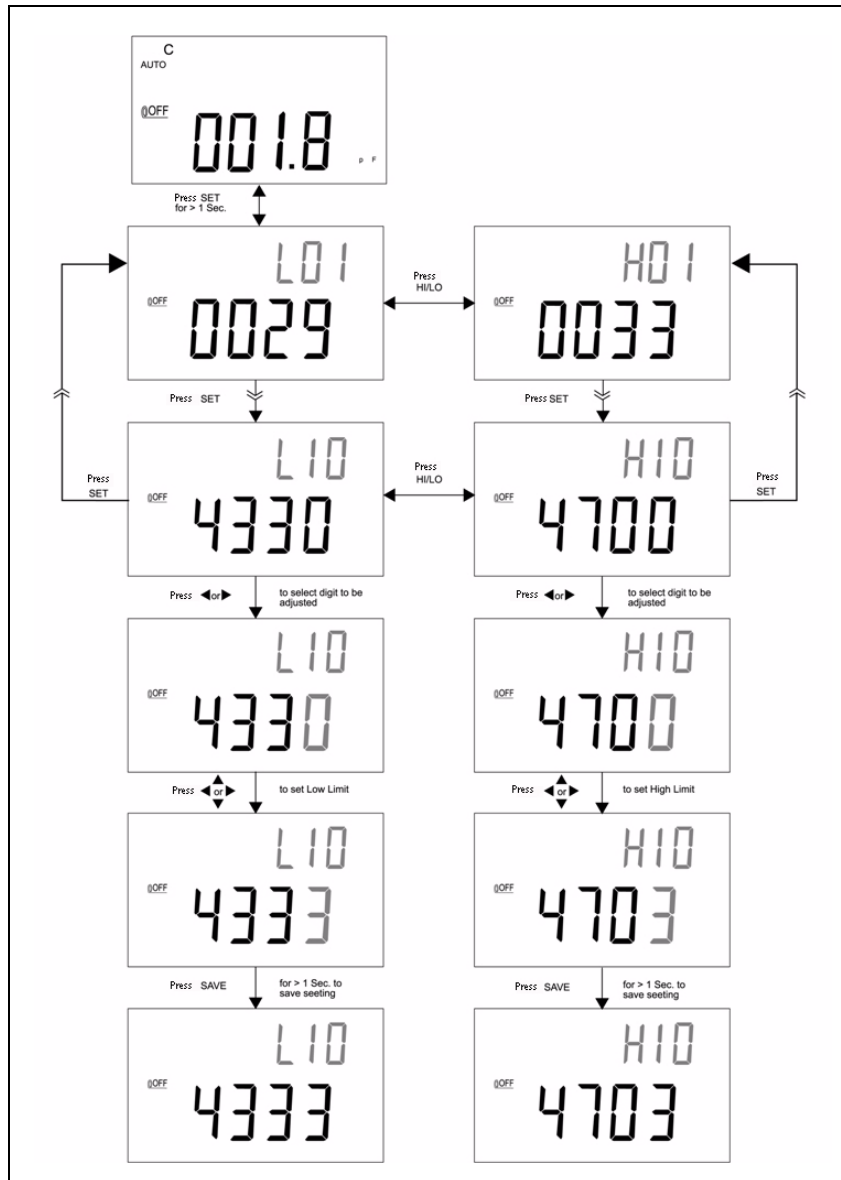

Figure 2-7 Setting High/ Low limits

Capacitance Measurement

CAUTION

To avoid possible damage to the meter or the equipment under test, disconnect circuit power and discharge the capacitor before measuring capacitance.

Capacitance is the ability of a component to store an electrical charge. The unit of capacitance is the farad (F). Most capacitors are within the range for nanofarad (nF) to microfarad (μ F). The meter measures capacitance by charging the capacitor with a known current, measuring the resulting time of charging period, and then calculating the capacitance. The larger capacitors will take longer time to charge. The sign of **C** flashing means that the meter is charging capacitor. To improve the measurement accuracy of small value capacitance, press **REL** with the alligator clip leads open to subtract the residual capacitance of the meter and leads.

NOTE

Measuring tip: For measuring capacitance $>1000 \mu$ F, discharge capacitor first and then select a suitable range to measure it. This will speed up the measuring time to achieve the correct value.

- 1 Power-on the meter.
- 2 To test for capacitance, keep an open circuit on the test leads and press **REL** key to subtract the residual capacitance of the meter and leads.
- 3 Insert the legs of the capacitor into + and - input sockets respectively. Ensure that the polarity of the capacitor's leg are correct.
- 4 Remove your hands from capacitor to allows it to be tested.
- 5 Read the measurement on the display.

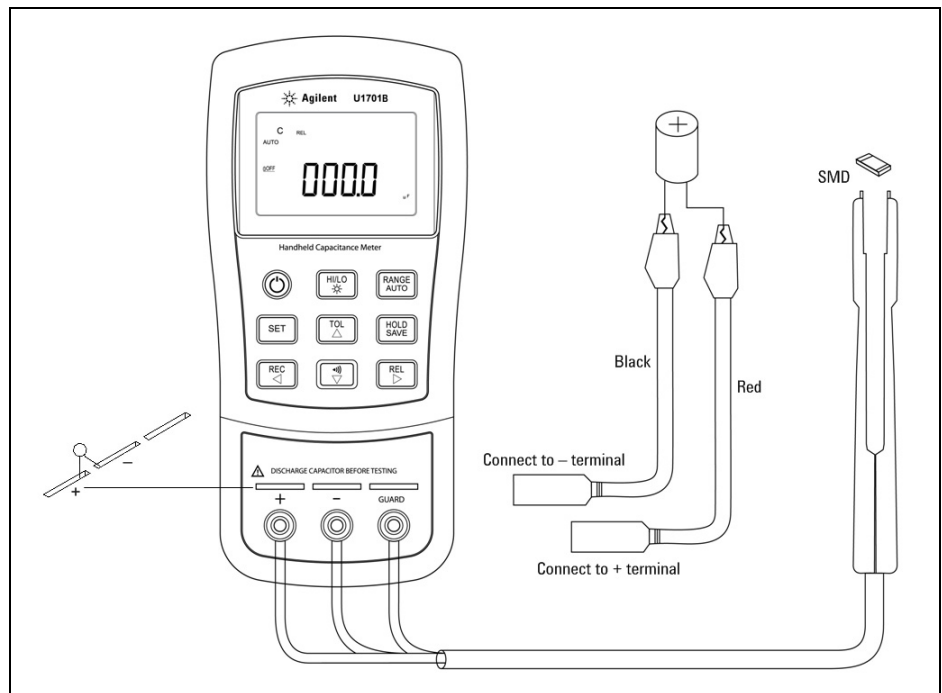

Figure 2-8 Capacitance measurement

Communication (Optional Accessories)

The meter is reserved with communication capability. The optional IR-USB package comes with full optical isolated cable and software. This function enables the user to record the data easily. Refer to the following procedures to set up the communication between your meter and personal computer (PC).

- 1 Connect one side of the cable to the meter with the Agilent Logo facing up and connect the USB connector to the PC.
- 2 Run the software to transfer the data to the PC for your applications.
- 3 To remove the cable, press and pull the snap ends on each side of the cable that is connected to the meter.

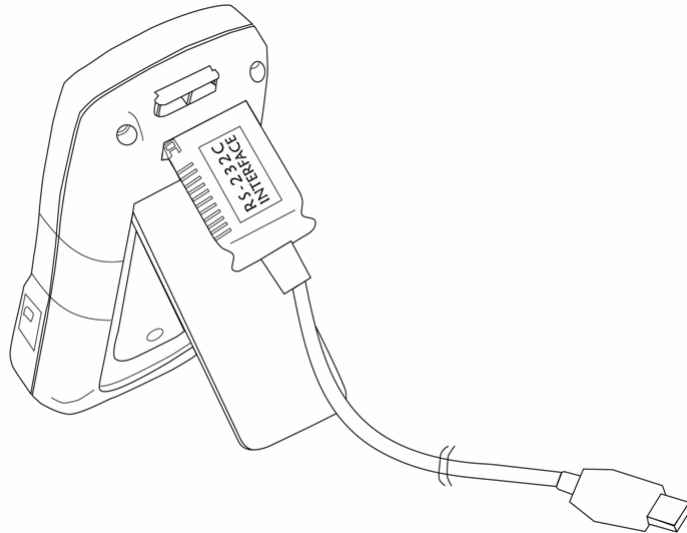

Figure 2-9 Cable connection of remote communication



3

Default Setting Configurations

Power-On Option	32
Setting Factory Default	34
Setting Baud Rate	35
Setting Parity Check	36
Setting Data Bit	37
Setting Echo	38
Setting Print Only	39
Setting Beep Frequency	40
Setting Keypad Lock	41
Setting Auto Power-Off	42
Setting Backlight Display	44
Setting Brightness Level of the Backlight for OFF State	45
Setting Brightness Level of the Backlight for ON State	46
Reset to Default	47

This chapter provides details on how to change and configure the default setting of U1701B and other setting features.



Power-On Option

To select power-on options listed in [Table 3-1](#), press and hold the respective key then press ON/OFF key to power-on the meter.

Table 3-1 Power-ON Options

Key	Selectable Parameters
HOLD	Demonstrate Annunciators To demonstrate the annunciators, the entire annunciators will be displayed. Press any key to exit demonstration mode.
	Reset the high and the low limits to factory's default values.
RANGE	Fast power off test for factory's purpose
REL	To view the firmware version
SET	Setup mode Configure related parameter, please refer to "Selecting Setup Mode" for more details

Demonstrate Display Annunciators

To demonstrate the annunciators, press **HOLD** and turn on the meter simultaneously. All annunciators will be displayed. Press any key to exit demonstration mode.

Default Factory HI/LO Setting

To set the high and the low limits to manufacture's default values.

Selecting Setup Mode

Press and hold **SET** key and power-on the instrument from OFF status. Release **SET** key when you hear a beep, the instrument will then enter setup mode. These parameters will be remained in the non-volatile memory even after the instrument is turned off. To configure the related parameters on setup mode, ensure that the following procedures are followed:

- 1 Press ◀ (Left) or ▶ (Right) key to select which menu item to be set.
- 2 Press ▲ (Up) or ▼ (Down) key to change the parameter.
- 3 Press **SET** key to select the digit to be adjusted, the selected digit will flash.
- 4 Press and hold **SAVE** key for more than 1 s to save your setting.
- 5 Press **SET** key for more than 1 s to exit setup mode.

Setting Factory Default

Table 3-2 lists out the setup menu item and factory default settings.

Table 3-2 Outline of setup menu items

Menu item	Factory Setting	Selectable Parameters
bAUd	9600	Baud rate: 2400, 4800, 9600, 19200
PArT	none	Parity: odd, even or none
Data	8-b	8 bits or 7 bits (Stop bit is always 1 bit)
Echo	oFF	Echo: on or oFF
Prnt	oFF	Print: on or oFF
beep	4800	Driving frequency: 4800, 2400, 1200, 600 Hz. oFF means to disable beep.
LbUt	oFF	Lock keys, oFF: enable keypad on: disable keypad
AoFF	15	1~99 minutes, oFF means to disable auto power off.
blit	30	1~99 seconds, oFF means to disable turning off backlight automatically.
boFF	oFF	Bright level of backlight at OFF state: oFF~09
bon	09	Bright level of backlight at ON state: oFF~09
dEFA	rSt	Reset above item to factory original setting.

NOTE

Press **SAVE** key to implement the above settings.

Setting Baud Rate

The baud rate is selected for remote control. It can be set to 2400, 4800, 9600 or 19200. To select your desired rate, refer to [Figure 3-1](#).

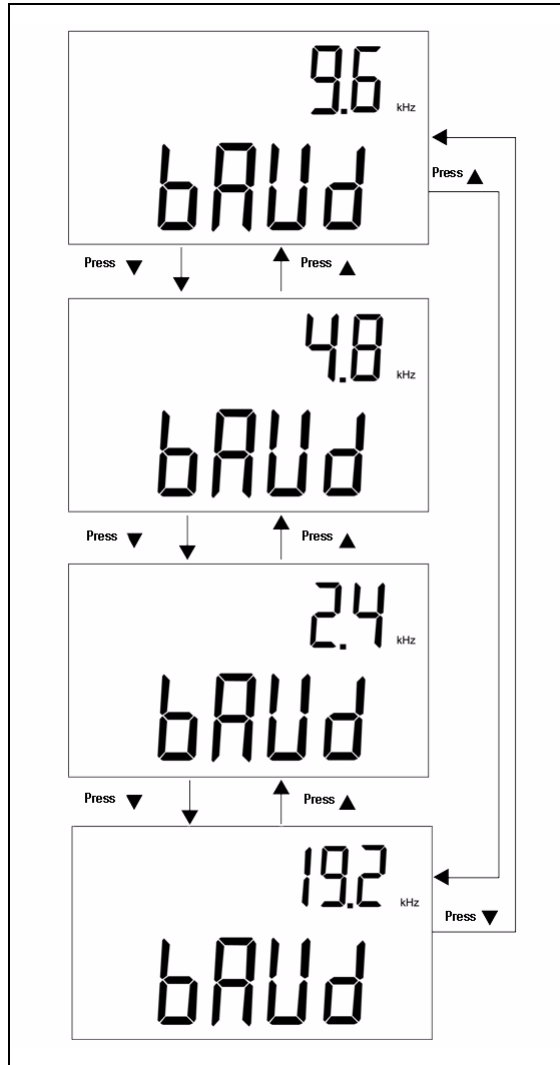

Figure 3-1 Baud rate setup for remote control

Setting Parity Check

The parity check is selected for remote control. It can be set to none, even or odd bit. To select the parity, refer to [Figure 3-2](#).

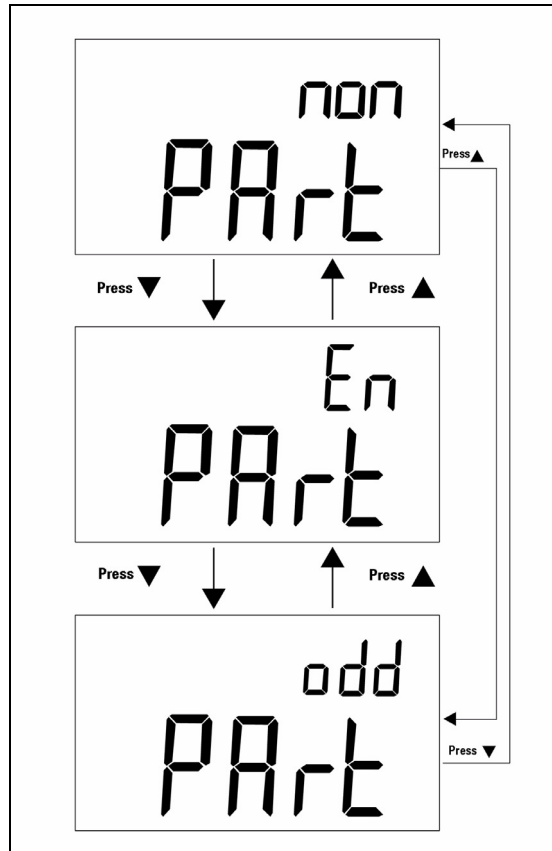

Figure 3-2 Parity check setup for remote control

Setting Data Bit

The data bit is selected for remote control. It can be set to 8 bits or 7 bits. The stop bit is defined to 1 bit and cannot be changed. To select the data bit, refer to [Figure 3-3](#).

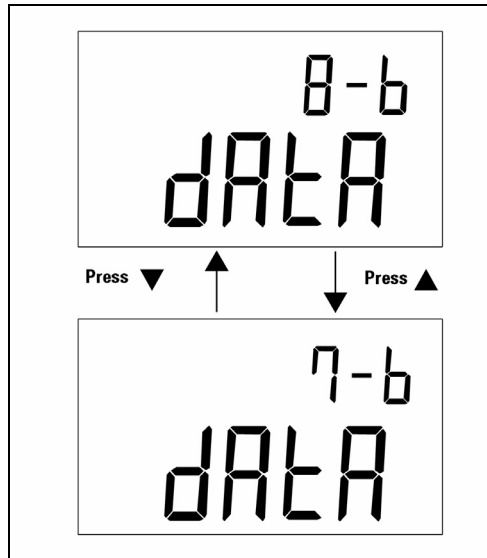

Figure 3-3 Data bit setup for remote control

Setting Echo

When the meter is set to ECHO ON, the meter echoes (returns) all the characters what it receives. To enable the Echo, refer to [Figure 3-4](#).

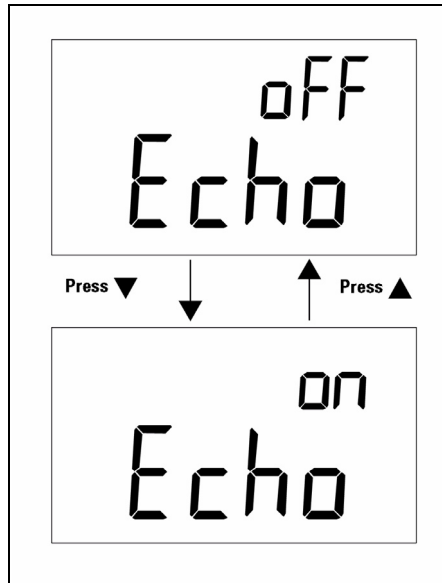

Figure 3-4 Echo Setup

Setting Print Only

If the remote interface of the meter is under print-only mode, the meter will print out only the measured data when the measuring cycle is completed. The meter will auto-send the latest data to a host continuously. The meter will not accept any commands from the host when print-only is enabled. The remote indicator of the meter will be flashed during operation as Print-only ON. To enable the print-only, refer to [Figure 3-5](#).

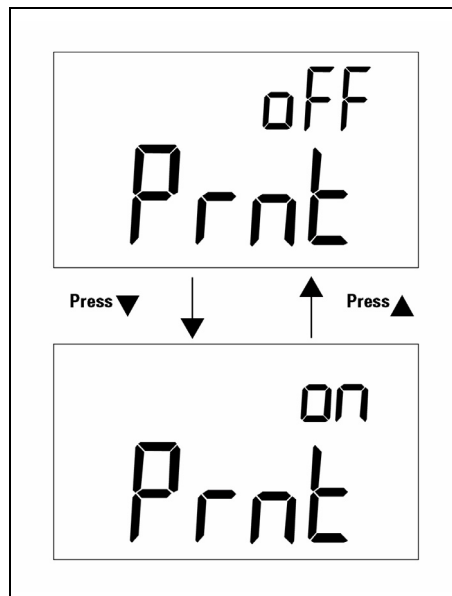

Figure 3-5 Print-only Setup

Setting Beep Frequency

The driving frequency can be set to 4800, 2400, 1200, or 600. The beeper can be set to **oFF** if you want to keep it silent during operation. To select a preferred tone, refer to [Figure 3-6](#).

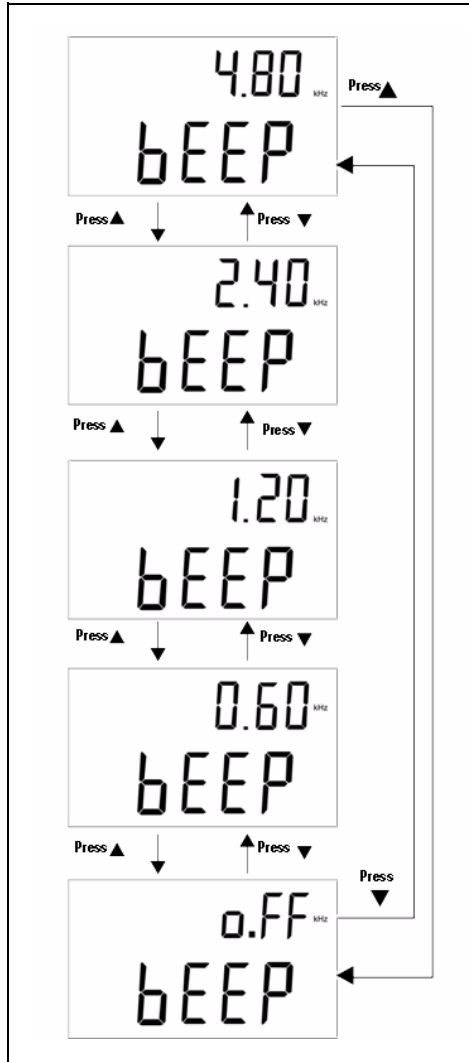

Figure 3-6 Driving frequency of Beeper setup

Setting Keypad Lock

The keypad can be disabled with the use of this option. When this setting is enabled, all the keys are disabled except for the power ON/OFF key. To enable or disable keypad lock, refer to [Figure 3-7](#).

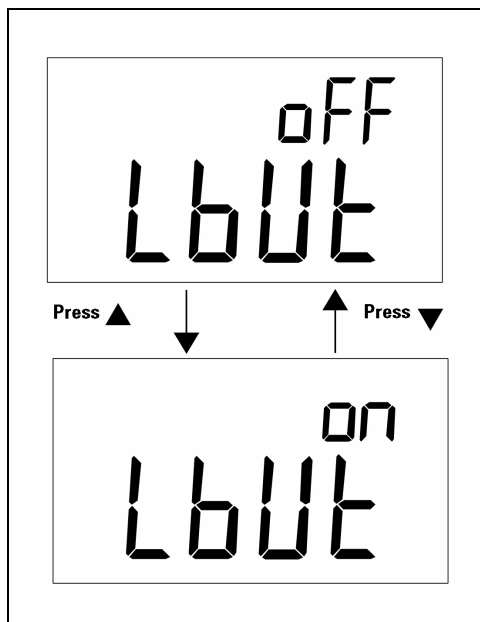

Figure 3-7 Keypad lock

Setting Auto Power-Off

The timer for Auto Power-Off (APO) can be set ranging from 1 minute to 99 minutes, **oFF** means that the auto power-off function is disabled. To set timer, refer to [Figure 3-8](#).

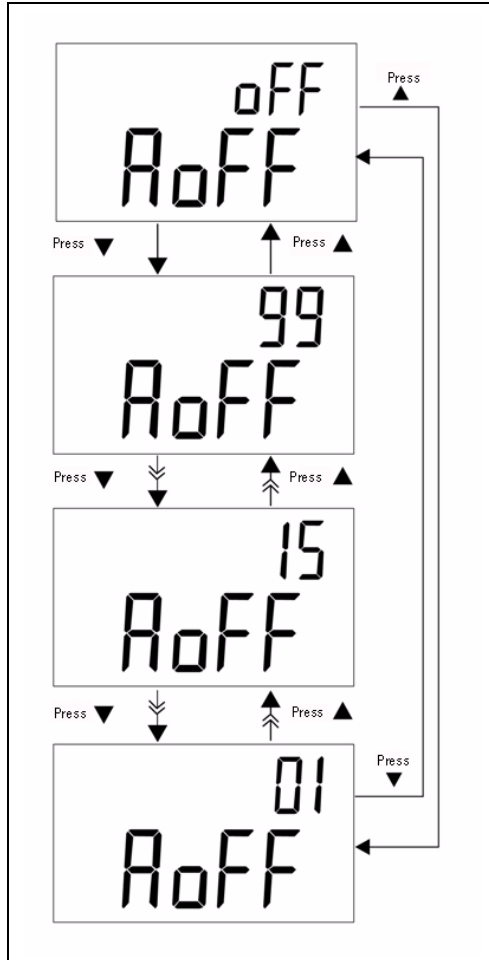

Figure 3-8 Auto power saving setup

The meter will not be automatically powered off within the setting period, if any of the following happens:

- a** Keypad is being used
- b** Static recording is set
- c** Auto power-off has been disabled by Setup Mode

You can toggle the power ON/OFF key to activate the meter after auto power-off, or press any keys to activate the meter. When the meter will be used for longer period, you may disable the APO. The @OFF indicator will be turned off when APO is disabled. The meter will operate continuously when APO is disabled.

Setting Backlight Display

The timer can be set ranging from 1 s to 99 s, **oFF** means that the backlight will not be automatically disabled. The backlight will be turned off automatically after a setting period. To set the timer, refer to [Figure 3-9](#).

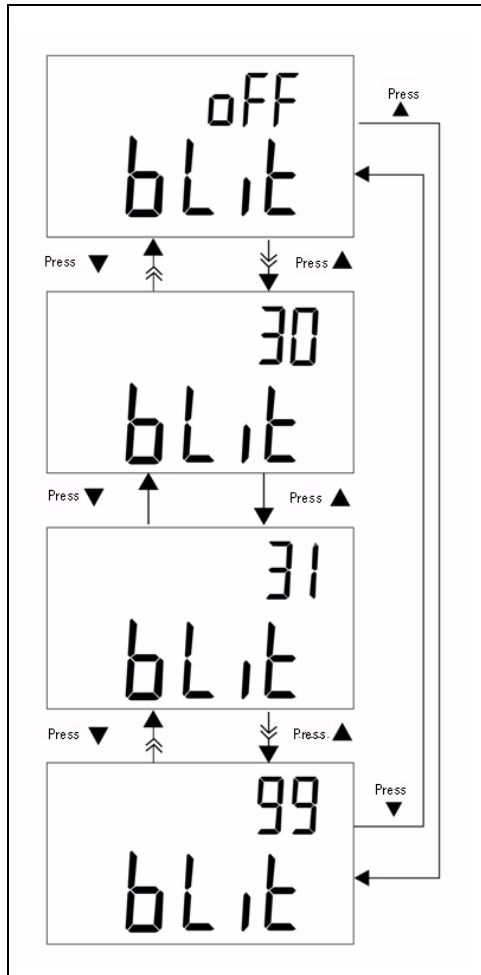

Figure 3-9 Backlight timer setup

Setting Brightness Level of the Backlight for OFF State

This option is used to set the brightness level for the backlight during OFF state. The brightness can be set from **oFF~09**.

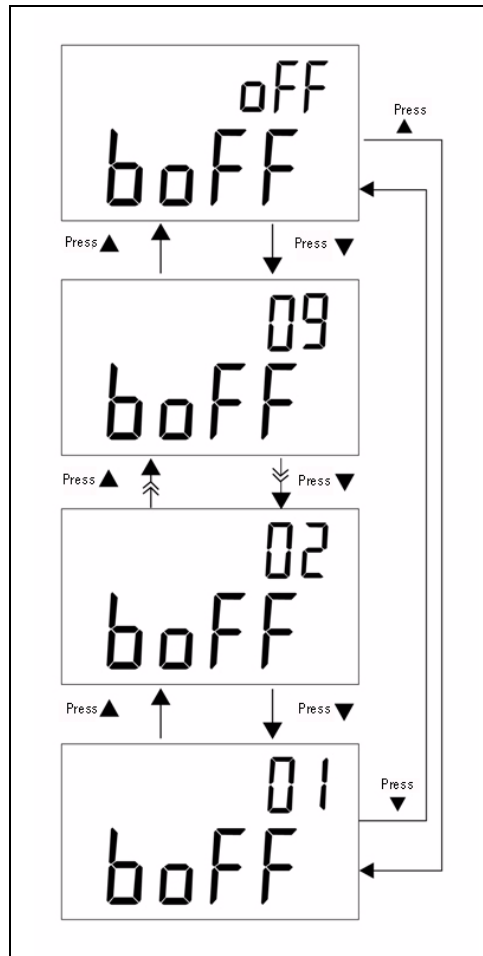

Figure 3-10 Brightness level for OFF state

Setting Brightness Level of the Backlight for ON State

This option is used to set the brightness level for the backlight during ON state. It is used to set brightness after the backlight is turned on. It can be set from **oFF**~09. When you turn on the backlight during normal operation, press **SET** key once to increase one level. The adjusting range is from default to 09 then back to default settings. For example, if the brightness level is set to 05, press **SET** key to increase the level from 05 until 09 then back to 05 after the backlight is turned on as normal operation. If the default is set to 09, there will be no changes when the **SET** key is pressed.

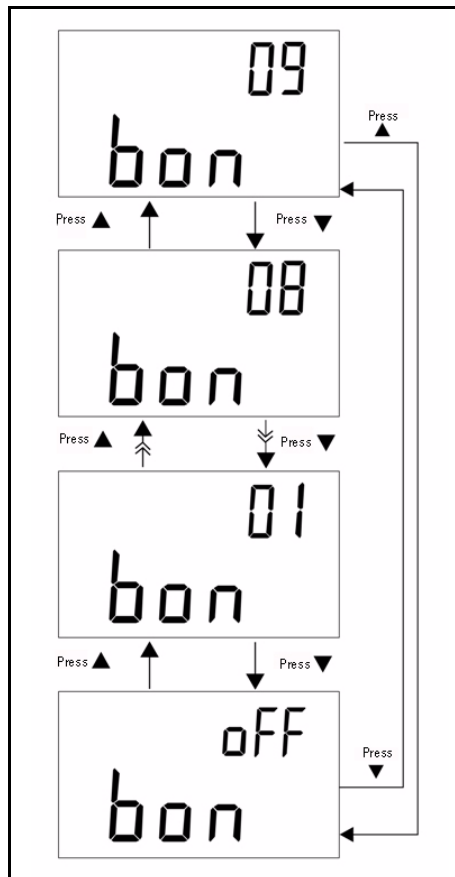

Figure 3-11 Brightness level for ON state

Reset to Default

Press **SAVE** key for more than 1 s to reset the setting to the default factory settings. The setup mode will be set to Baud Rate menu item automatically after resetting the meter.

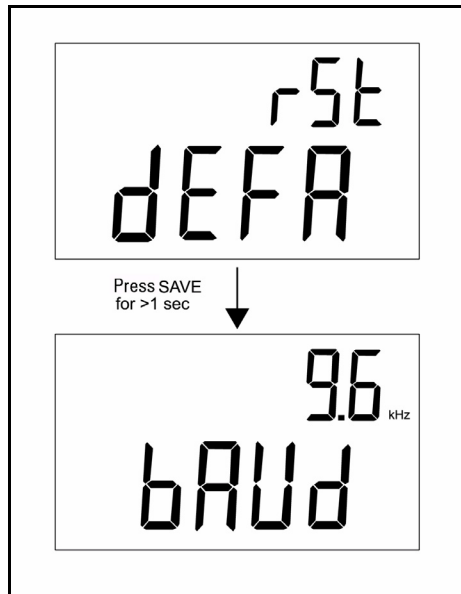

Figure 3-12 Reset to default

3 Default Setting Configurations



4

Service and Maintenance

General Maintenance	50
Battery Replacement	51
Cleaning	52
Specification Validation	53

This chapter provides information on warranty services, maintenance procedures, and troubleshooting hints to solve general problems that you may encounter with the instrument. Repair or service which are not covered in this manual should only be performed by qualified personnel.



General Maintenance

WARNING

To avoid electrical shock, do not perform any service unless you are qualified to do so.

If the instrument fails to operate, check battery and alligator clip leads, and replace them if necessary. If the instrument is still not working, double check the operating procedure as described in this User's and Service Guide. When servicing, use specified replacement parts only. [Table 4-1](#) contains the list of basic problems.

Table 4-1 Basic problems

Malfunction	Identification
No LCD indication as power ON	<ul style="list-style-type: none"> • Check whether the power key has been locked completely. • Check the battery or replace battery.
No beeper tone	<ul style="list-style-type: none"> • Check setup mode whether the beeper has been set to OFF. Then select the desired driving frequency.
Keypad failure	<ul style="list-style-type: none"> • Check whether the meter is under remote control. • Turn OFF and then turn ON the meter again. • Check the setup mode whether Lbut of lock keys has been set on.
Failed on Remote control	<ul style="list-style-type: none"> • The optical side of cable connected to meter, the Agilent logo on the cover should be facing up.

Battery Replacement

WARNING

Remove all test leads and external adaptor before opening the case.

CAUTION

To avoid instruments being damage from battery leakage:

- Always remove dead batteries immediately.
- Always remove the battery and store it separately if the meter is not going to be used for a long period.

The meter is powered by 9 V battery, ensure that only the specified battery is used. You are required to replace the battery immediately when the  annunciator is flashing. To replace the battery, refer to the following procedures:

- 1 Remove alligator clip leads and power-off the meter.
- 2 Unscrew the screw on the battery cover (see [Figure 4-1](#)).
- 3 Slide down the battery cover and remove the cover.
- 4 Replace the battery with a specified 9 V battery.
- 5 Reverse the procedure step **3** and **4** to close the bottom cover.

Battery Type	ANSI/NEDA	IEC
Alkaline	1604A	6LR61

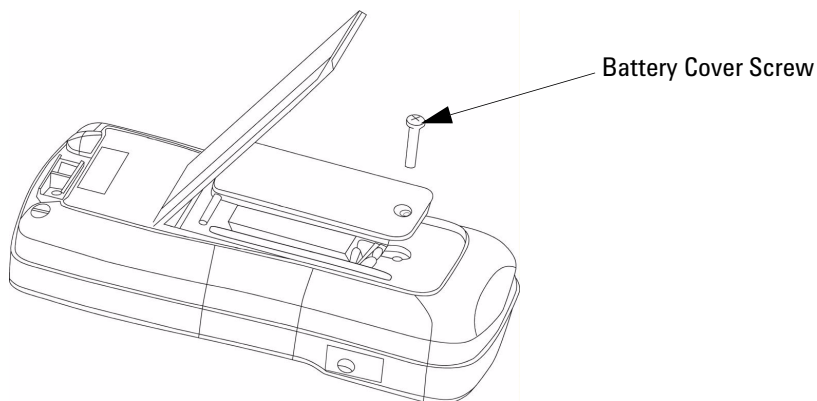

Figure 4-1 Battery replacement

Cleaning

WARNING

To avoid electrical shock or damage to the meter, do not get water inside the case

To clean the instrument, use a soft cloth dampened in a solution of mild detergent and water. Do not spray cleaner directly onto the instrument as it may leak into the cabinet and cause damage. Do not use chemicals containing benzene, benzene, toluene, xylene, acetone or similar solvents to clean the instrument. After cleaning, ensure that the instrument is completely dry before using.

Specification Validation

You can perform self-validation of the capacitance meter's accuracy by using the recommended equipment with the specified test ranges below.

Table 4-2 Recommended Equipment List

Standard Source	Operating Range	Limit	Recommended Equipment
Capacitance	1 nF ~10 nF	± 0.5%	Fluke 5520A
Calibrator	100 nF ~10 mF	± 0.25%	or equivalent

Table 4-3 Ranges of Functional Validation

Range	Test Value Used
1000.0 p	500 p
1000.0 n	500 n
1000.0 μ	500 μ
199.99 m	100 m

4 Service and Maintenance

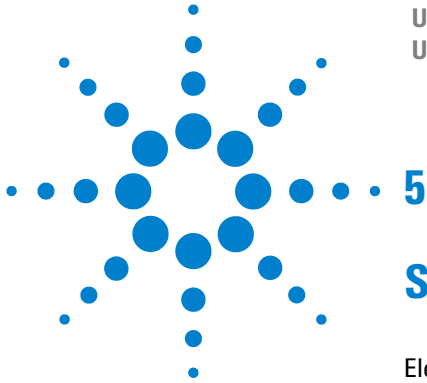

5

Specifications and Characteristics

Electrical Specifications	56
General Specifications	57
SMD Tweezers Specifications	58

This chapter contains the U1701B's electrical specifications, general specifications, and SMD Tweezers' specifications.



Electrical Specifications^{*}

Accuracy is given as \pm (% of reading + counts of least significant digit) at 23 °C \pm 5 °C, with relative humidity less than 80% R.H.

For example, 1% \pm 10 = 1% of reading + 10 counts of least significant digit

Capacitance

Range	Resolution	Accuracy [*]	Measuring rate (approx.)
1000.0 pF	0.1 pF	1% +10	5 times/s
10.000 nF	0.001 nF	1% +5	5 times/s
100.00 nF	0.01 nF	0.5% +3	5 times/s
1000.0 nF	0.1 nF		5 times/s
10.000 μ F	0.001 μ F		5 times/s
100.00 μ F	0.01 μ F		5 times/s
1000.0 μ F	0.1 μ F		0.86 times/s
10.000 mF	0.001 mF	1% +5	0.13 times/s
199.99 mF	0.1 mF	2% +5	0.006 times/s

* The accuracy is specified to measure film capacitor or better, and use Relative mode to zero residual first.

* This specification is based on the measurement performed at the test socket.

General Specifications

Parameter	U1701B
Power Supply	Single standard 9 V battery (Alkaline) (Power adaptor is available as optional accessories)
Display	4 ½-digit liquid crystal display (LCD) with maximum reading of 11,000 counts and automatic polarity indication
Function	<ul style="list-style-type: none"> • Capacitance measurement by DC charge and discharge method • Visible and audible Tolerance mode assists you to sort the capacitor • Min/Max/Average, Data Hold with Manual or Auto Trigger and Relative modes • Comparison mode with 25 sets of HI/LO limits can be selected • backlight display for easy reading in the dark • One-year calibration cycle suggested
Measuring rate	~5 times/s for capacitance <100 µF (Typical)
Battery type	Alkaline: ANSI/NEDA: 1604A / IEC: 6LR61
Power consumption	5.6 mA (Battery operation)
Battery life	~80 hours without backlight based on new alkaline
Operating temperature	0 °C to 50 °C
Storage temperature	-20 °C to 60 °C
Storage humidity	0 – 80% R.H. non condensing
Relative Humidity (R.H.)	80% R.H.
Temperature coefficient	0.1 * (Specified Accuracy)/ °C (from 0 °C to 18 °C or 28 °C to 50 °C)
Low battery indicator	 will appear when the voltage drops below ~ 6.0 V
Weight	320 g
Dimension (W x L x H)	87 mm x 184 mm x 41 mm
Safety	Designed in compliance with IEC 61010-1 for Pollution Degree 2
Warranty	<p>Please refer to http://www.agilent.com/go/warranty_terms</p> <ul style="list-style-type: none"> • Three years for the product • Three months for the product's standard accessories, unless otherwise specified <p>Please take note that for the product, the warranty does not cover:</p> <ul style="list-style-type: none"> • Damage from contamination • Normal wear and tear of mechanical components • Manuals and standard disposable batteries

SMD Tweezers Specifications

The Agilent U1782B is a tweezers to be used with the U1700 Series Handheld LCR Meters. This tweezers is useful when measuring SMD-type components. Plug in the base of the tweezers to the LCR meter's + (HI-SENSE), - (LO-SENSE) and GUARD ends. Ensure that the orientation of the base matches the polarity of the LCR meter.

It is recommended to measure the SMD components length as well as the maximum opening of the tweezers. The length of the tweezers is approximately 815 mm (32.08 inches) (see [Figure 5-1](#)).

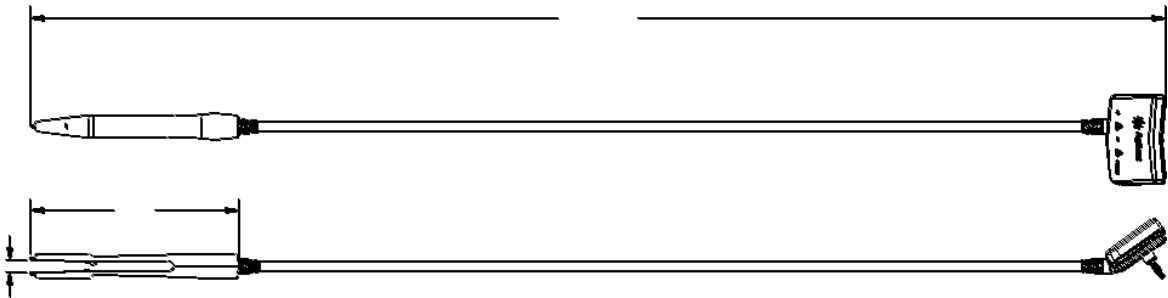

Figure 5-1 SMD Tweezers

Electrical Characteristics

Parameters	Test Condition	100 Hz	120 Hz	1 kHz	10 kHz	100 kHz
Cp Parallel Capacitance	Tweezers Open	<0.7 pF	<0.7 pF	<0.7 pF	<0.7 pF	<0.7 pF
Rs Series Resistance	Tweezers Short	<0.5 Ω	<0.5 Ω	<0.5 Ω	<0.5 Ω	<0.5 Ω
Ls Series Inductance	Tweezers Short	<1.2 μ H	<1.2 μ H	<1.2 μ H	<1.2 μ H	<1.2 μ H

NOTE

- 1 The specification is specified at 23 °C \pm 5 °C and <75% R.H.
- 2 You are recommended to perform an open/short calibration on the LCR meter before using the tweezers.

5 Specifications and Characteristics

www.agilent.com

Contact us

To obtain service, warranty or technical support assistance, contact us at the following phone numbers:

United States:

(tel) 800 829 4444 (fax) 800 829 4433

Canada:

(tel) 877 894 4414 (fax) 800 746 4866

China:

(tel) 800 810 0189 (fax) 800 820 2816

Europe:

(tel) 31 20 547 2111

Japan:

(tel) (81) 426 56 7832 (fax) (81) 426 56 7840

Korea:

(tel) (080) 769 0800 (fax) (080) 769 0900

Latin America:

(tel) (305) 269 7500

Taiwan:

(tel) 0800 047 866 (fax) 0800 286 331

Other Asia Pacific Countries:

(tel) (65) 6375 8100 (fax) (65) 6755 0042

Or visit Agilent worldwide web at:

www.agilent.com/find/assist

Product specifications and descriptions in this document subject to change without notice. Always refer to the Agilent Web site for the latest revision.

© Agilent Technologies, Inc. 2009, 2012

Printed in Malaysia

Third Edition, June 25, 2012

U1701-90055



Agilent Technologies