

TTG-EL84PSE Output Transformer

Toroidal Parallel Single Ended output transformer with UL tap, for tubes EL84 , 6V6 (6П6С) , 6BQ5 , 6P14P (6П14П) introduces benefits of toroidal cores to tube output. Through the use of innovative, internationally patented winding technology, we have achieved exceptional electrical parameters, such as flat frequency bandwidth in acoustic range, very low THD distortion and high quality factor.

Transformer is also available in stainless steel box potted EXPO version.

Technical Data:

Nominal power:	50W
Nominal anode current:	200mA
Frequency bandwidth (-3dB):	10Hz – 56kHz
Secondary inductance:	4 i 8 Ω
Primary Impedance:	2,5 kΩ
Turns Ratio (Np:Ns):	25,00:1 (4Ω) , 17,68:1 (8Ω)
Primary Inductance Lp:	30 H
Primary Leakage Inductance Lsp:	2,11mH
Total Primary DC Resistance:	98,8 Ω

Core type:	Toroidal
Intended for:	Single Ended, 43% UL

Wiring diagram:

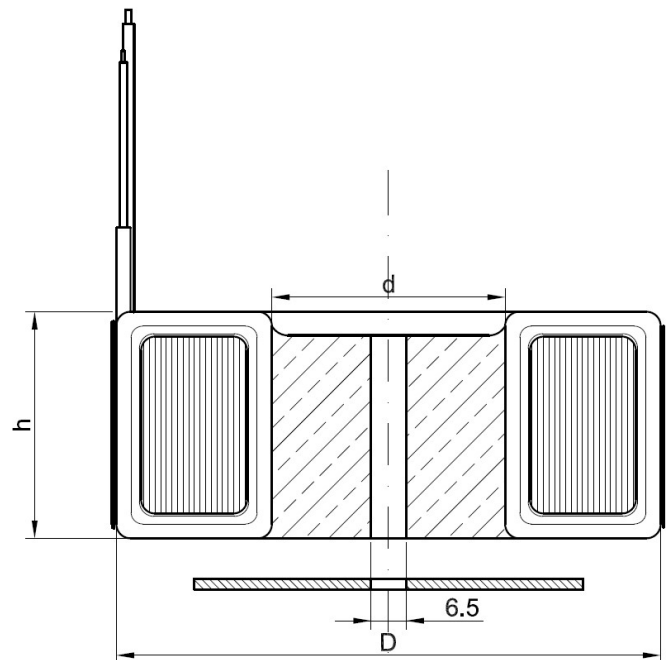
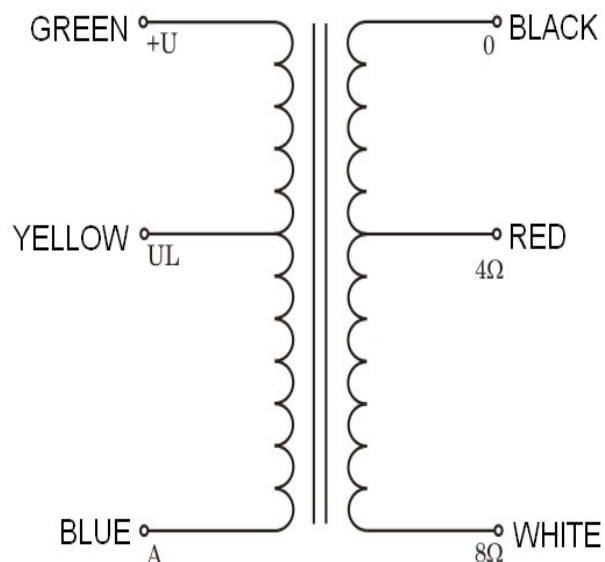

DIMENSIONS:

Outer diameter (D):	115mm
Inner diameter (d):	40mm
Height (h):	65mm
Weight:	2,4 kg
Leads length:	250mm