

Specification of DO-35 NTC Thermistor

PART NUMBER: **TT-DO-10KC3-8**

No. of pages: 9

Date: **20.02.2019**

Revision: **00**

FEATURES:

Element	DO-35 NTC Thermistor
No-load resistance at 25°C	10 000 Ω
Tolerance at 25°C	± 1%
Beta(25/85) Constant	3 977K ±1%
Operating temperature range	-40°C ÷ 225°C

DRAWING:

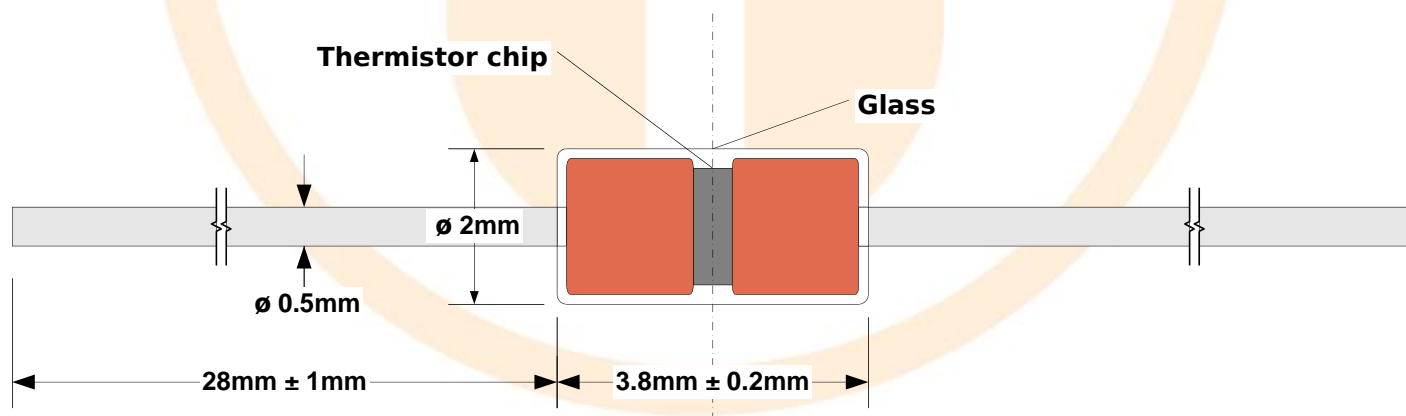

UNITS: [mm]