

## FEATURES

- Guaranteed Output Current of 150mA
- Highly Output Accuracy:  $\pm 1.0\%$
- Low Quiescent Current
- Very Low Dropout Voltage
- Ultra Low Noise Output
- Excellent Line and Load Regulation
- Fixed Output Voltage: 1.2V, 1.8V, 2.5V, and 3.3V
- Adjustable Output Voltage: 1.5V to 12V
- Logic Controlled Shutdown Option
- Stable with Low ESR MLCC
- Over Current Protection
- Over Temperature Protection
- Available in SOT-23-5L Package

## APPLICATIONS

- Mobile Phones and Smart Phones
- Digital Cameras and Camcorders
- Portable Communication Devices
- GPS, PDAs and handhelds
- Battery-Powered Devices
- SMPS Post-regulator/DC to DC Modules
- High-efficiency Linear Power Supplies

## DESCRIPTION

The TPS761xx is an efficient linear voltage regulator with ultra-low noise output, very low dropout voltage, and very low ground current.

The TPS761xx offers better than 1% initial accuracy. Designed especially for hand-held, battery-powered devices, the TPS761xx includes a CMOS or TTL compatible enable/shutdown control input. When shutdown, power consumption drops nearly to zero.

Regulator ground current increases only slightly in dropout, further prolonging battery life.

Key TPS761xx features include reversed-battery protection, current limiting, and over temperature shutdown.

The TPS761xx is available in fixed and adjustable output voltage versions in SOT-23-5 package. The maximum output voltage of the adjustable type is 12V.



## ORDERING INFORMATION

| Device      | Package   |
|-------------|-----------|
| TPS761xxSF5 | SOT-23-5L |

xx: Output Voltage

**ABSOLUTE MAXIMUM RATINGS** (Note 1)

| CHARACTERISTIC                       | SYMBOL     | MIN  | MAX | UNIT |
|--------------------------------------|------------|------|-----|------|
| Input Supply Voltage (Survival)      | $V_{IN}$   | -0.3 | 20  | V    |
| Enable Input Voltage (Survival)      | $V_{EN}$   | -0.3 | 20  | V    |
| Operating Junction Temperature Range | $T_{JOPR}$ | -40  | 125 | °C   |
| Storage Temperature Range            | $T_{STG}$  | -65  | 150 | °C   |

**RECOMMENDED OPERATING RATINGS** (Note 2)

| CHARACTERISTIC       | SYMBOL   | MIN | MAX      | UNIT |
|----------------------|----------|-----|----------|------|
| Input Supply Voltage | $V_{IN}$ | 2.0 | 16       | V    |
| Enable Input Voltage | $V_{EN}$ | 0   | $V_{IN}$ | V    |

**ORDERING INFORMATION**

| VOUT | Package   | Order No.   | Description        | Supplied As | Status     |
|------|-----------|-------------|--------------------|-------------|------------|
| ADJ  | SOT-23-5L | TPS76101SF5 | Enable, Adjustable | Tape & Reel | Contact Us |
| 2.5V | SOT-23-5L | TPS76125SF5 | Enable             | Tape & Reel | Contact Us |
| 2.8V | SOT-23-5L | TPS76128SF5 | Enable             | Tape & Reel | Contact Us |
| 3.0V | SOT-23-5L | TPS76130SF5 | Enable             | Tape & Reel | Contact Us |
| 3.3V | SOT-23-5L | TPS76133SF5 | Enable             | Tape & Reel | Active     |
| 3.6V | SOT-23-5L | TPS76136SF5 | Enable             | Tape & Reel | Contact Us |
| 5.0V | SOT-23-5L | TPS76150SF5 | Enable             | Tape & Reel | Contact Us |

## PIN CONFIGURATION

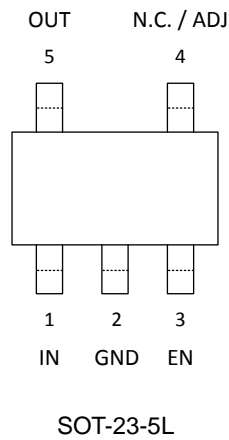

## PIN DESCRIPTION

| Pin No. | Pin Name | Pin Function  |
|---------|----------|---|
| 1       | IN       | Input Voltage.  |
| 2       | GND      | Ground.   |
| 3       | EN       | Enable Voltage. Do Not Float.   |
| 4       | N.C.     | No Connection for Fixed Output Version.   |
|         | ADJ      | Output Voltage Adjustable Input for Adjustable Output Version. Connect an external voltage divider to determine the output voltage. |
| 5       | OUT      | Output Voltage.   |

## TYPICAL APPLICATION CIRCUIT

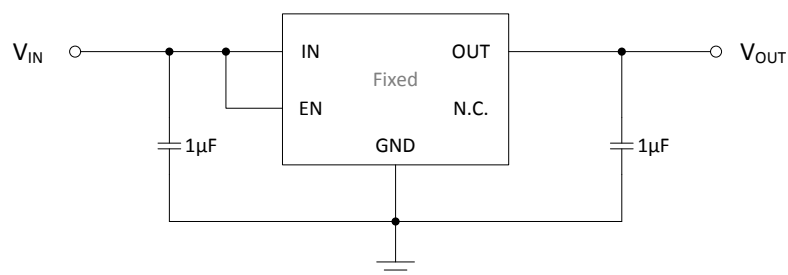
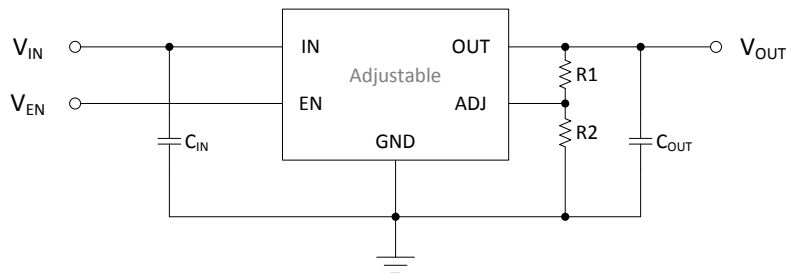
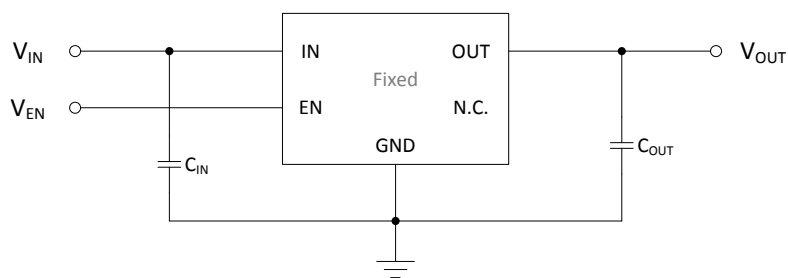
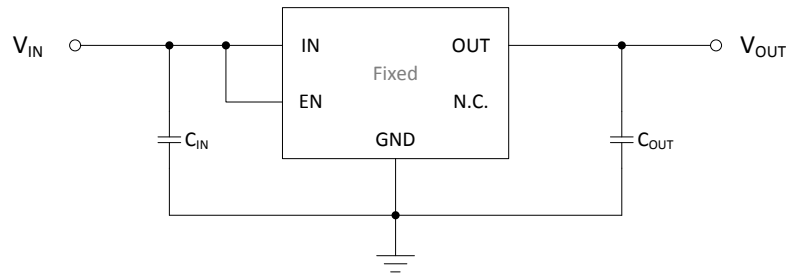

\* For the details, see Application Information.

\*\* TPS761xx can deliver a continuous current of 150 mA over the full operating temperature. However, the output current is limited by the restriction of power dissipation which differs from packages. A heat sink may be required depending on the maximum power dissipation and maximum ambient temperature of application. With respect to the applied package, the maximum output current of 150 mA may be still undeliverable.

## ELECTRICAL CHARACTERISTICS

Limits in standard typeface are for  $T_J = 25^\circ\text{C}$ , and limits in **boldface type** apply over the **full operating temperature range**.

$V_{IN} = V_{OUT(NOM)} + 1.0\text{ V}$  or  $V_{IN} = 2.0\text{ V}$ , whichever is greater;  $I_{OUT} = 100\ \mu\text{A}$ ,  $C_{IN} = C_{OUT} = 1.0\ \mu\text{F}$ , unless otherwise specified.

| PARAMETER                           | SYMBOL                    | TEST CONDITIONS                                    | MIN                   | TYP   | MAX                   | UNIT                  |
|-------------------------------------|---------------------------|--|-----------------------|-------|-----------------------|-----------------------|
| Output Voltage Tolerance            | $V_{OUT}$                 | $(V_{OUT} + 1.0\text{ V}) < V_{IN} < 6.5\text{ V}$ | -1<br><b>-2</b>       | 0     | 1<br><b>2</b>         | %                     |
| Adjustable Pin Voltage              | $V_{ADJ}$                 |  | 1.230<br><b>1.217</b> | 1.242 | 1.254<br><b>1.267</b> | V                     |
| Line Regulation                     | LNR                       | $(V_{OUT} + 1.0\text{ V}) < V_{IN} < 6.5\text{ V}$ | -                     | 0.004 | 0.012<br><b>0.05</b>  | %/V                   |
| Load Regulation <sup>(Note 3)</sup> | LDR                       | $100\ \mu\text{A} \leq I_{OUT} \leq 150\text{ mA}$ | -                     | 0.02  | 0.2<br><b>0.5</b>     | %                     |
| Dropout Voltage                     | $V_{DROPO}$               | $I_{OUT} = 100\ \mu\text{A}$                       | -                     | 10    | 50<br><b>70</b>       | mV                    |
|                                     |                           | $I_{OUT} = 50\text{ mA}$                           | -                     | 110   | 150<br><b>230</b>     |                       |
|                                     |                           | $I_{OUT} = 100\text{ mA}$                          | -                     | 140   | 250<br><b>300</b>     |                       |
|                                     |                           | $I_{OUT} = 150\text{ mA}$                          | -                     | 165   | 275<br><b>350</b>     |                       |
| Current Limit                       | $I_{CL}$                  | $V_{OUT} = 0\text{ V}$                             | -                     | 320   | 600                   | mA                    |
| Ground Current                      | $I_{GND}$                 | $I_{OUT} = 100\ \mu\text{A}$                       | -                     | 120   | 160<br><b>180</b>     | $\mu\text{A}$         |
|                                     |                           | $I_{OUT} = 50\text{ mA}$                           | -                     | 350   | 600<br><b>800</b>     |                       |
|                                     |                           | $I_{OUT} = 100\text{ mA}$                          | -                     | 600   | 1000<br><b>1500</b>   |                       |
|                                     |                           | $I_{OUT} = 150\text{ mA}$                          | -                     | 1300  | 1900<br><b>2500</b>   |                       |
| Shutdown Current                    | $I_{SD}$                  | $V_{EN} \leq 0.4\text{ V}$                         | -                     | 0.01  | 1.0<br><b>5.0</b>     | $\mu\text{A}$         |
| EN Threshold Logic Low              | $V_{ENL}$                 | Output = Low                                       | -                     | -     | 0.4                   | V                     |
| EN Threshold Logic High             | $V_{ENH}$                 | Output = High                                      | 2.0                   | -     | -                     | V                     |
| EN Input Current Low                | $I_{ENL}$                 | $V_{EN} \leq 0.4\text{ V}$                         | -                     | 0.01  | 1.0<br><b>2.0</b>     | $\mu\text{A}$         |
| EN Input Current High               | $I_{ENH}$                 | $V_{EN} \geq 2.0\text{ V}$                         | 2.0                   | 5.0   | 35<br><b>40</b>       | $\mu\text{A}$         |
| $V_{OUT}$ Temperature Coefficient   | $\Delta V_{OUT}/\Delta T$ | <sup>(Note 4)</sup>                                | -                     | 40    | -                     | ppm/ $^\circ\text{C}$ |
| Power Supply Ripple Rejection       | PSRR                      | $I_{OUT} = 100\ \mu\text{A}$ , $f = 100\text{ Hz}$ | -                     | 75    | -                     | dB                    |

Note 1. Exceeding the absolute maximum ratings may damage the device.

Note 2. The device is not guaranteed to function outside its operating ratings.

Note 3. Regulation is measured at constant junction temperature using low duty cycle pulse testing.

Note 4. Output voltage temperature coefficient is defined as the worst case voltage change divided by the total temperature range.

## TYPICAL OPERATING CHARACTERISTICS

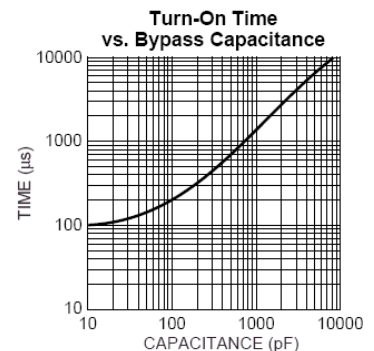
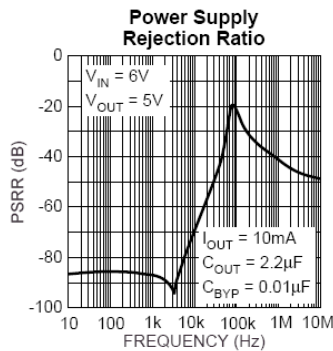
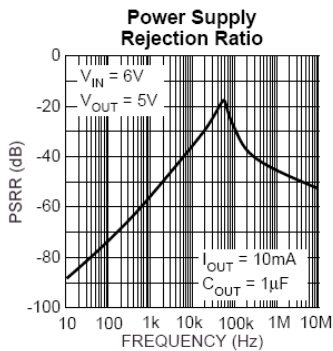
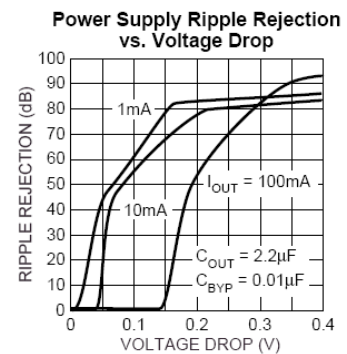
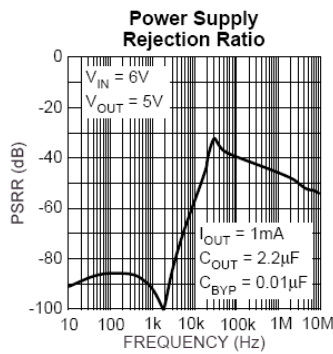
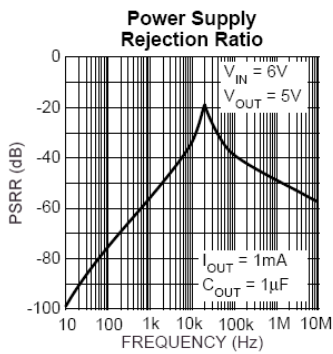
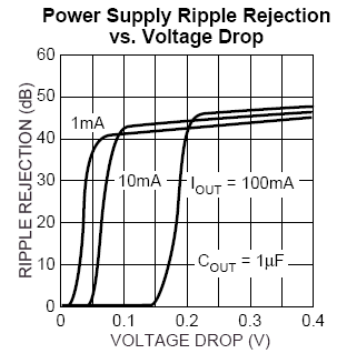
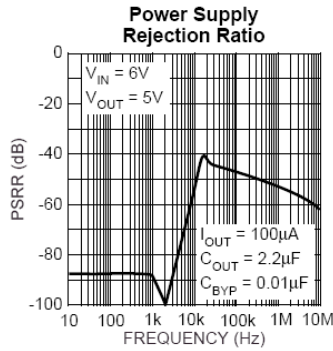
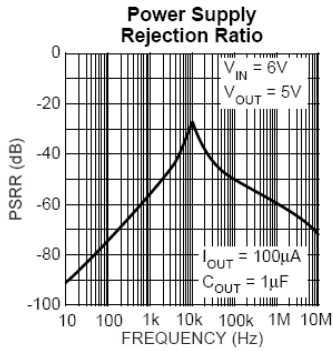

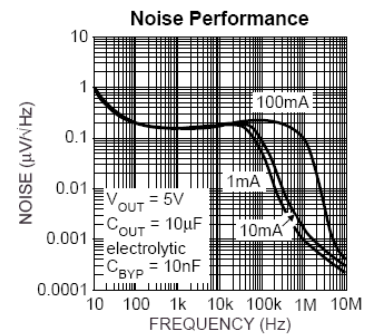
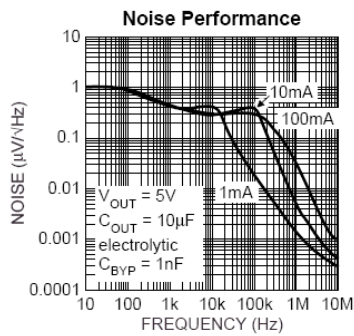
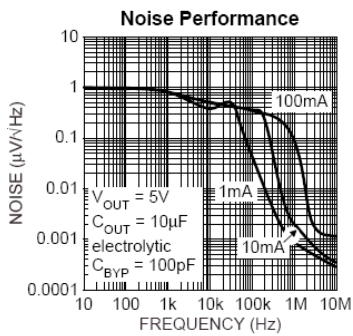
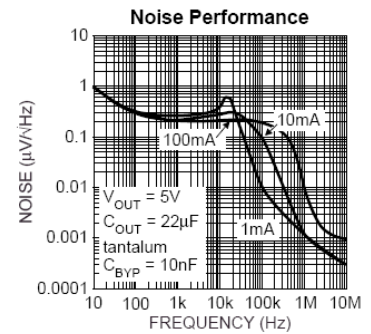
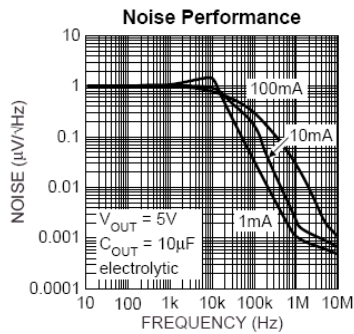
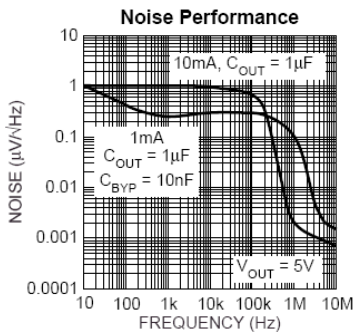
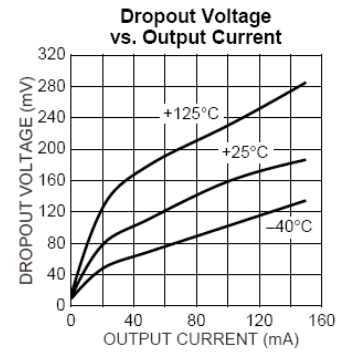
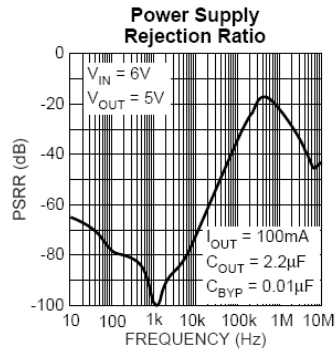
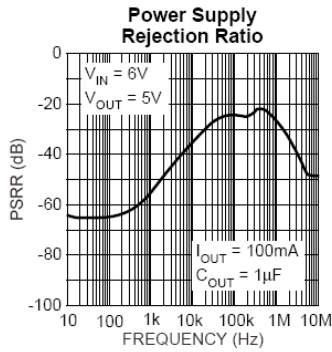

## APPLICATION INFORMATION

The TPS761xx consists of a high-precision voltage reference, an error correction circuit, and a current limited output driver. With good transient responses, output remains stable even during load changes. The EN input enables the output to be turned off, resulting in reduced power consumption. The TPS761xx incorporates both over-temperature and over-current protection.

### INPUT CAPACITOR

An input capacitor of minimum 1.0  $\mu\text{F}$  of MLCC is recommended. Larger values will help to improve ripple rejection by bypassing the input to the regulator, further improving the integrity of the output voltage. X7R or X5R dielectrics are recommended and it should be placed as close as to the IN pin as possible.

### OUTPUT CAPACITOR

The TPS761xx requires a minimum output capacitance maintain stability. The TPS761xx is designed to be stable with a MLCC with very low equivalent series resistance (ESR). A 1.0  $\mu\text{F}$  of MLCC would satisfy most applications. Larger values and lower ESR improves dynamic performance. X7R or X5R dielectrics are recommended to maintain sufficient capacitance over its full operating temperature. It should be placed as close as OUT pin as possible.

### OUTPUT ADJUSTMENT

The operating condition of  $V_{\text{IN}}$  and the operating characteristics of  $V_{\text{OUT}}$  depend on the dropout voltage performance in accordance with output load current.

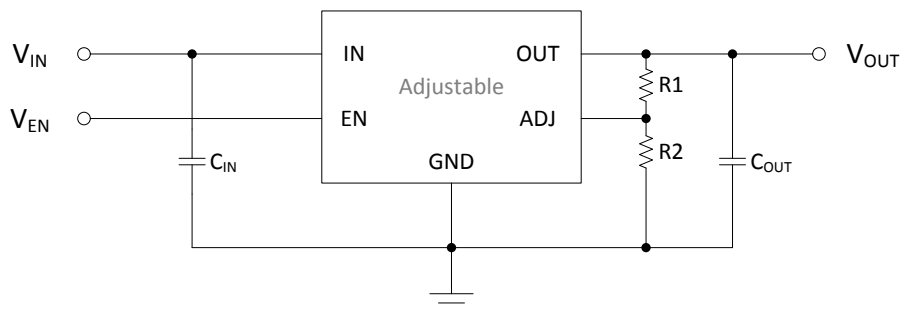

$$V_{\text{OUT}} = V_{\text{ADJ}} (1 + R2 / R1)$$

### MAXIMUM OUTPUT CURRENT CAPABILITY

The TPS761xx can deliver a continuous current of 150mA over the full operating junction temperature range. However, the output current is limited by the restriction of power dissipation of package. With respect to the applied package, the maximum output current of 150mA may be still undeliverable due to the restriction of the power dissipation of TPS761xx. Under all possible conditions, the junction temperature must be within the range specified under operating conditions.

The temperatures over the device are given by:

$$T_C = T_A + P_D \times \theta_{\text{CA}}$$

$$T_J = T_C + P_D \times \theta_{\text{JC}}$$



$$T_J = T_A + P_D \times \theta_{JA}$$

where  $T_J$  is the junction temperature,  $T_C$  is the case temperature,  $T_A$  is the ambient temperature,  $P_D$  is the total power dissipation of the device,  $\theta_{CA}$  is the thermal resistance of case-to-ambient,  $\theta_{JC}$  is the thermal resistance of junction-to-case, and  $\theta_{JA}$  is the thermal resistance of junction to ambient.

The total power dissipation of the device is given by:

$$\begin{aligned} P_D &= P_{IN} - P_{OUT} = (V_{IN} \times I_{IN}) - (V_{OUT} \times I_{OUT}) \\ &= (V_{IN} \times (I_{OUT} + I_{GND})) - (V_{OUT} \times I_{OUT}) = (V_{IN} - V_{OUT}) \times I_{OUT} + V_{IN} \times I_{GND} \end{aligned}$$

where  $I_{GND}$  is the operating ground current of the device which is specified at the Electrical Characteristics. The maximum allowable temperature rise ( $T_{Rmax}$ ) depends on the maximum ambient temperature ( $T_{Amax}$ ) of the application, and the maximum allowable junction temperature ( $T_{Jmax}$ ):

$$T_{Rmax} = T_{Jmax} - T_{Amax}$$

The maximum allowable value for junction-to-ambient thermal resistance,  $\theta_{JA}$ , can be calculated using the formula:

$$\theta_{JA} = T_{Rmax} / P_D$$

If proper cooling solution such as copper plane area or air flow is applied, the maximum allowable power dissipation could be increased. However, if the ambient temperature is increased, the allowable power dissipation would be decreased.

## REVISION NOTICE

The description in this datasheet is subject to change without any notice to describe its electrical characteristics properly.