

TLP3122A

1. Applications

- Measuring Instruments
- Security Systems
- ATE (Automatic Test Equipment)
- Factory Automation (FA)
- Battery Management System (BMS) (Non-Automotive)
- Programmable Logic Controllers (PLCs)
- Mechanical relay replacements

2. General

The Toshiba TLP3122A consists of an infrared LED optically coupled to a photo-MOSFET in a 4-pin SO6 package. This photorelay has higher output current rating than phototransistor-type photocoupler; hence, it is suitable for use as On/Off control for high current.

3. Features

- (1) Halogen-free
For details, see "Devices in Halogen-Free Resin Packages" at the end of this datasheet.
- (2) Operating temperature range: 110°C(max)
- (3) Normally opened (1-Form-A)
- (4) OFF-state output terminal voltage: 60 V (min)
- (5) Trigger LED current: 3 mA (max)
- (6) ON-state current: 1.4A (max)
- (7) ON-state resistance: 0.25 Ω (max)
- (8) Isolation voltage: 3750 Vrms (min)
- (9) Safety standards
UL-recognized: UL 1577, File No.E67349
cUL-recognized: CSA Component Acceptance Service No.5A File No.E67349
UL-recognized: UL 508, File No.E499232 (**Note 1**)
VDE-approved: EN 60747-5-5 (**Note 2**)

Note 1: Please refer Absolute Maximum Ratings (UL-recognized UL 508) for UL 508 products.

Note 2: When a VDE approved type is needed, please designate the **Option (V4)**.

Table 3.1 Mechanical Parameters

| Characteristics | TLP3122A | Unit |
|------------------------------|-----------|------|
| Creepage distances | 5.0 (min) | mm |
| Clearance distances | 5.0 (min) | |
| Internal isolation thickness | 0.2 (min) | |

Start of commercial production
2017-12

4. Packaging and Pin Assignment

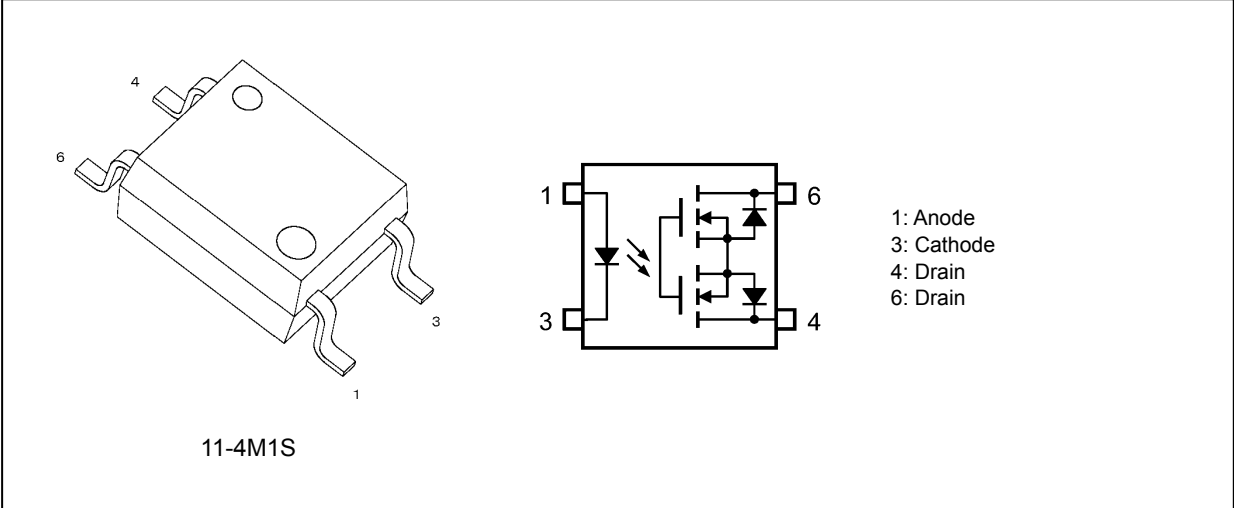

5. Internal Circuit

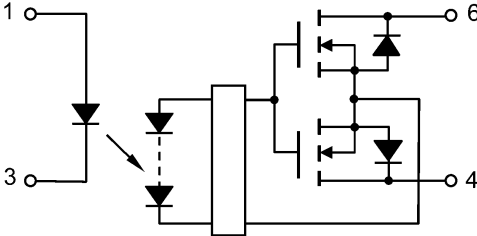

6. Absolute Maximum Ratings (Note) (Unless otherwise specified, $T_a = 25\text{ }^\circ\text{C}$)

| | Characteristics | Symbol | Note | Rating | Unit |
|----------|--|----------------------------|----------|------------|----------------------|
| LED | Input forward current | I_F | | 50 | mA |
| | Input forward current derating ($T_a \geq 25\text{ }^\circ\text{C}$) | $\Delta I_F/\Delta T_a$ | | -0.5 | mA/ $^\circ\text{C}$ |
| | Input forward current (pulsed) (100 μs pulse, 100 pps) | I_{FP} | | 1 | A |
| | Input reverse voltage | V_R | | 6 | V |
| | Input power dissipation | P_D | | 50 | mW |
| | Input power dissipation derating ($T_a \geq 25\text{ }^\circ\text{C}$) | $\Delta P_D/\Delta T_a$ | | -0.5 | mW/ $^\circ\text{C}$ |
| | Junction temperature | T_j | | 125 | $^\circ\text{C}$ |
| Detector | OFF-state output terminal voltage | V_{OFF} | | 60 | V |
| | ON-state current | I_{ON} | | 1.4 | A |
| | ON-state current derating ($T_a \geq 25\text{ }^\circ\text{C}$) | $\Delta I_{ON}/\Delta T_a$ | | -14.0 | mA/ $^\circ\text{C}$ |
| | ON-state current (pulsed) ($t = 100\text{ ms}$, duty = 1/10) | I_{ONP} | | 4.2 | A |
| | Output power dissipation | P_O | | 400 | mW |
| | Output power dissipation derating ($T_a \geq 25\text{ }^\circ\text{C}$) | $\Delta P_O/\Delta T_a$ | | -4.0 | mW/ $^\circ\text{C}$ |
| | Junction temperature | T_j | | 125 | $^\circ\text{C}$ |
| Common | Storage temperature | T_{stg} | | -55 to 125 | $^\circ\text{C}$ |
| | Operating temperature | T_{opr} | | -40 to 110 | $^\circ\text{C}$ |
| | Lead soldering temperature (10 s) | T_{sol} | | 260 | $^\circ\text{C}$ |
| | Isolation voltage (AC, 60 s, R.H. $\leq 60\%$) | BV_S | (Note 1) | 3750 | Vrms |

Note: Using continuously under heavy loads (e.g. the application of high temperature/current/voltage and the significant change in temperature, etc.) may cause this product to decrease in the reliability significantly even if the operating conditions (i.e. operating temperature/current/voltage, etc.) are within the absolute maximum ratings.

Please design the appropriate reliability upon reviewing the Toshiba Semiconductor Reliability Handbook ("Handling Precautions"/"Derating Concept and Methods") and individual reliability data (i.e. reliability test report and estimated failure rate, etc).

Note 1: This device is considered as a two-terminal device: Pins 1 and 3 are shorted together, and pins 4 and 6 are shorted together.

7. Recommended Operating Conditions (Note)

| Characteristics | Symbol | Note | Min | Typ. | Max | Unit |
|-----------------------|-----------|------|-----|------|-----|------------------|
| Supply voltage | V_{DD} | | — | — | 48 | V |
| Input forward current | I_F | | 5 | 7.5 | 25 | mA |
| ON-state current | I_{ON} | | — | — | 1.4 | A |
| Operating temperature | T_{opr} | | -40 | — | 100 | $^\circ\text{C}$ |

Note: The recommended operating conditions are given as a design guide necessary to obtain the intended performance of the device. Each parameter is an independent value. When creating a system design using this device, the electrical characteristics specified in this datasheet should also be considered.

8. Absolute Maximum Ratings (UL-recognized: UL 508) (Note) (Unless otherwise specified, $T_a = 25\text{ }^\circ\text{C}$)

| | Characteristics | Symbol | Note | Rating | Unit |
|----------|--|------------------------------|----------|------------|----------------------|
| LED | Input forward current | I_F | | 50 | mA |
| | Input forward current derating ($T_a \geq 25\text{ }^\circ\text{C}$) | $\Delta I_F / \Delta T_a$ | | -0.5 | mA/ $^\circ\text{C}$ |
| | Input forward current (pulsed) (100 μs pulse, 100 pps) | I_{FP} | | 1 | A |
| | Input reverse voltage | V_R | | 6 | V |
| | Input power dissipation | P_D | | 50 | mW |
| | Input power dissipation derating ($T_a \geq 25\text{ }^\circ\text{C}$) | $\Delta P_D / \Delta T_a$ | | -0.5 | mW/ $^\circ\text{C}$ |
| | Junction temperature | T_j | | 105 | $^\circ\text{C}$ |
| Detector | OFF-state output terminal voltage | V_{OFF} | | 60 | V |
| | ON-state current | I_{ON} | | 1.4 | A |
| | ON-state current derating ($T_a \geq 25\text{ }^\circ\text{C}$) | $\Delta I_{ON} / \Delta T_a$ | | -14.0 | mA/ $^\circ\text{C}$ |
| | ON-state current (pulsed) ($t = 100\text{ ms}$, duty = 1/10) | I_{ONP} | | 4.2 | A |
| | Output power dissipation | P_O | | 400 | mW |
| | Output power dissipation derating ($T_a \geq 25\text{ }^\circ\text{C}$) | $\Delta P_O / \Delta T_a$ | | -4.0 | mW/ $^\circ\text{C}$ |
| | Junction temperature | T_j | | 105 | $^\circ\text{C}$ |
| Common | Storage temperature | T_{stg} | | -55 to 125 | $^\circ\text{C}$ |
| | Case temperature | T_c | | 105 | $^\circ\text{C}$ |
| | Operating temperature | T_{opr} | | -40 to 85 | $^\circ\text{C}$ |
| | Lead soldering temperature (10 s) | T_{sol} | | 260 | $^\circ\text{C}$ |
| | Isolation voltage (AC, 60 s, R.H. $\leq 60\%$) | BV_S | (Note 1) | 3750 | Vrms |

Note: Using continuously under heavy loads (e.g. the application of high temperature/current/voltage and the significant change in temperature, etc.) may cause this product to decrease in the reliability significantly even if the operating conditions (i.e. operating temperature/current/voltage, etc.) are within the absolute maximum ratings.

Please design the appropriate reliability upon reviewing the Toshiba Semiconductor Reliability Handbook ("Handling Precautions"/"Derating Concept and Methods") and individual reliability data (i.e. reliability test report and estimated failure rate, etc).

Note 1: This device is considered as a two-terminal device: Pins 1 and 3 are shorted together, and pins 4 and 6 are shorted together.

9. Recommended Operating Conditions (UL-recognized: UL 508) (Note)

| Characteristics | Symbol | Note | Min | Typ. | Max | Unit |
|-----------------------|-----------|----------|-----|------|------|------------------|
| Supply voltage | V_{DD} | | — | — | 48 | V |
| Input forward current | I_F | (Note 1) | 5 | 7.5 | 32.5 | mA |
| ON-state current | I_{ON} | (Note 1) | — | — | 0.9 | A |
| Operating temperature | T_{opr} | | -20 | — | 85 | $^\circ\text{C}$ |

Note: The recommended operating conditions are given as a design guide necessary to obtain the intended performance of the device. Each parameter is an independent value. When creating a system design using this device, the electrical characteristics specified in this data sheet should also be considered.

Note 1: The above recommended operating conditions are at $T_a = 60\text{ }^\circ\text{C}$.

However, within the derating range of the characteristic curves of " $I_F - T_a$ ", " $I_{ON} - T_a$ ", it can be used up to $85\text{ }^\circ\text{C}$.

10. Electrical Characteristics (Unless otherwise specified, $T_a = 25\text{ }^\circ\text{C}$)

| | Characteristics | Symbol | Note | Test Condition | Min | Typ. | Max | Unit |
|----------|-----------------------|-----------|------|------------------------------------|-----|-------|-----|---------------|
| LED | Input forward voltage | V_F | | $I_F = 10\text{ mA}$ | 1.1 | 1.27 | 1.4 | V |
| | Input reverse current | I_R | | $V_R = 5\text{ V}$ | — | — | 10 | μA |
| | Input capacitance | C_t | | $V = 0\text{ V}, f = 1\text{ MHz}$ | — | 30 | — | pF |
| Detector | OFF-state current | I_{OFF} | | $V_{OFF} = 60\text{ V}$ | — | 0.002 | 1 | μA |
| | Output capacitance | C_{OFF} | | $V = 0\text{ V}, f = 1\text{ MHz}$ | — | 100 | — | pF |

11. Coupled Electrical Characteristics (Unless otherwise specified, $T_a = 25\text{ }^\circ\text{C}$)

| | Characteristics | Symbol | Note | Test Condition | Min | Typ. | Max | Unit |
|--|---------------------|----------|------|--|-----|------|------|----------|
| | Trigger LED current | I_{FT} | | $I_{ON} = 1.4\text{ A}$ | — | 1 | 3 | mA |
| | Return LED current | I_{FC} | | $I_{OFF} = 100\text{ }\mu\text{A}$ | 0.1 | — | — | mA |
| | ON-state resistance | R_{ON} | | $I_{ON} = 1.4\text{ A}, I_F = 5\text{ mA}, t < 1\text{ s}$ | — | 0.13 | 0.25 | Ω |

12. Isolation Characteristics (Unless otherwise specified, $T_a = 25\text{ }^\circ\text{C}$)

| | Characteristics | Symbol | Note | Test Condition | Min | Typ. | Max | Unit |
|--|-------------------------------------|--------|----------|--------------------------------------|--------------------|-----------|-----|----------|
| | Total capacitance (input to output) | C_S | (Note 1) | $V_S = 0\text{ V}, f = 1\text{ MHz}$ | — | 0.8 | — | pF |
| | Isolation resistance | R_S | (Note 1) | $V_S = 500\text{ V}, R.H. \leq 60\%$ | 5×10^{10} | 10^{14} | — | Ω |
| | Isolation voltage | BV_S | (Note 1) | AC, 60 s | 3750 | — | — | Vrms |

Note 1: This device is considered as a two-terminal device: Pins 1 and 3 are shorted together, and pins 4 and 6 are shorted together.

13. Switching Characteristics (Unless otherwise specified, $T_a = 25\text{ }^\circ\text{C}$)

| | Characteristics | Symbol | Note | Test Condition | Min | Typ. | Max | Unit |
|--|-----------------|-----------|------|---|-----|------|-----|------|
| | Turn-on time | t_{ON} | | See Fig. 13.1 $R_L = 200\text{ }\Omega, V_{DD} = 20\text{ V}, I_F = 5\text{ mA}$ | — | 2 | 3 | ms |
| | Turn-off time | t_{OFF} | | | — | 0.1 | 1 | |

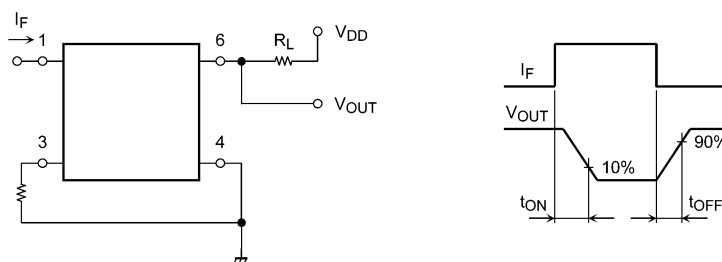

Fig. 13.1 Switching Time Test Circuit and Waveform

14. Characteristics Curves and Circuit Connections

14.1. Characteristics Curves (Note)

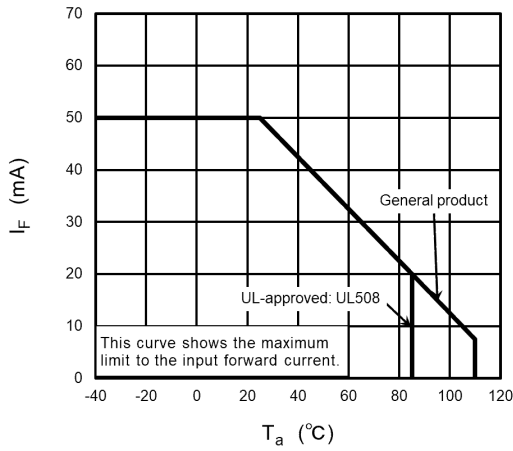

Fig. 14.1.1 $I_F - T_a$

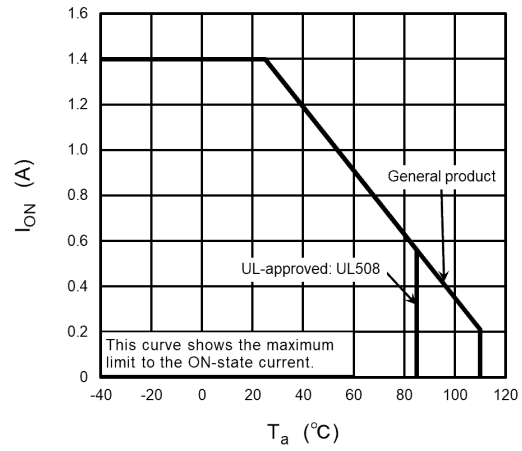

Fig. 14.1.2 $I_{ON} - T_a$

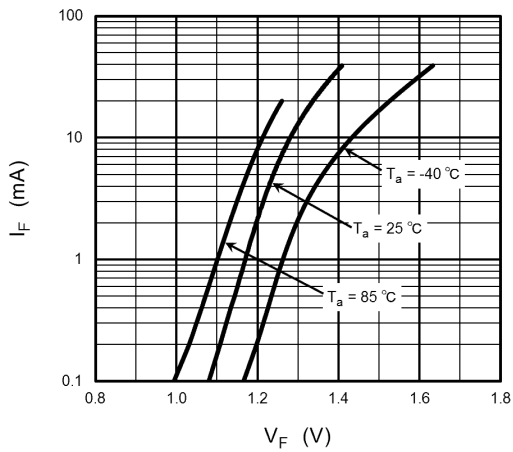

Fig. 14.1.3 $I_F - V_F$

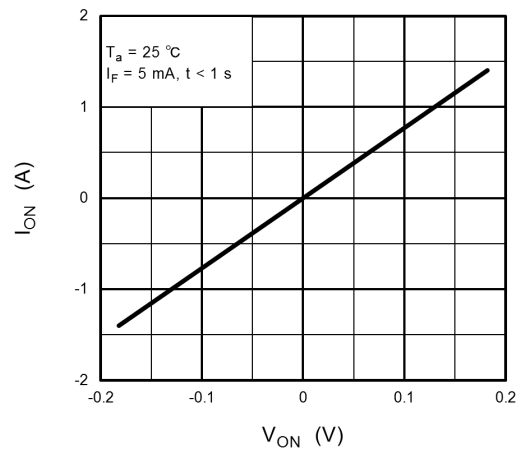

Fig. 14.1.4 $I_{ON} - V_{ON}$

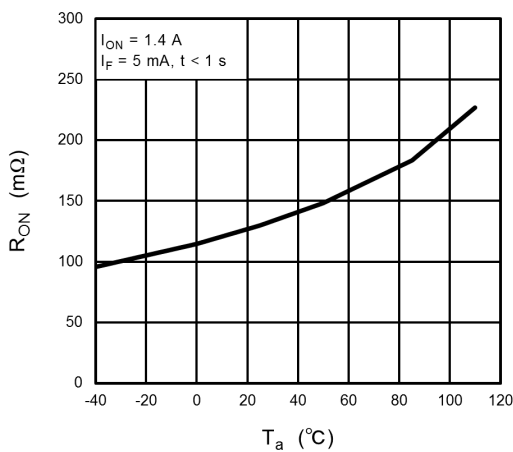

Fig. 14.1.5 $R_{ON} - T_a$

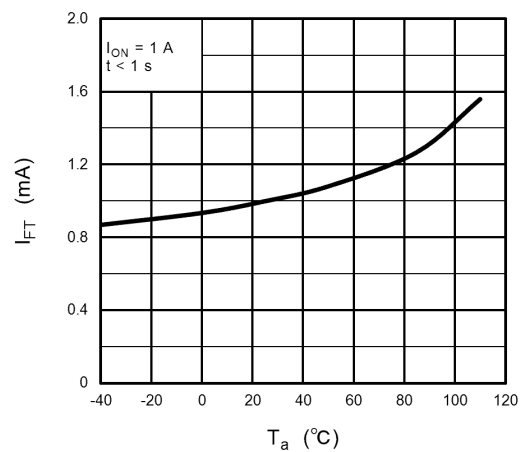

Fig. 14.1.6 $I_{FT} - T_a$

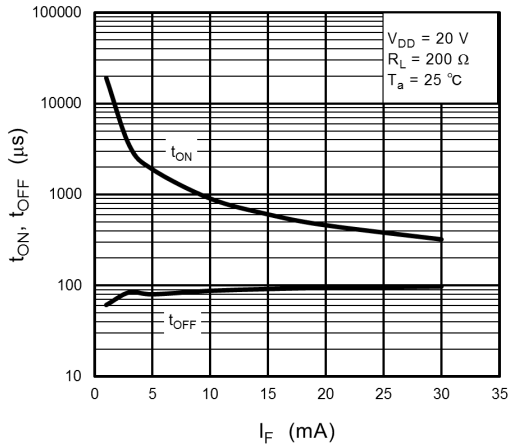

Fig. 14.1.7 $t_{ON}, t_{OFF} - I_F$

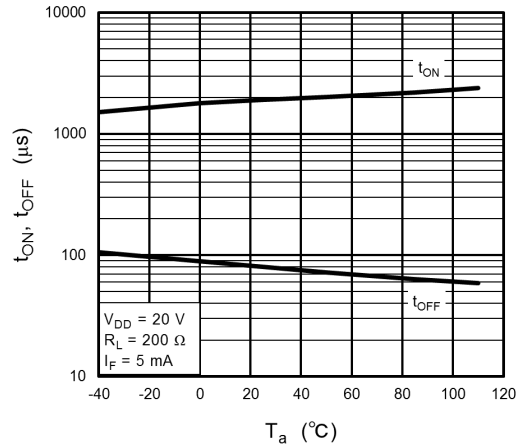

Fig. 14.1.8 $t_{ON}, t_{OFF} - T_a$

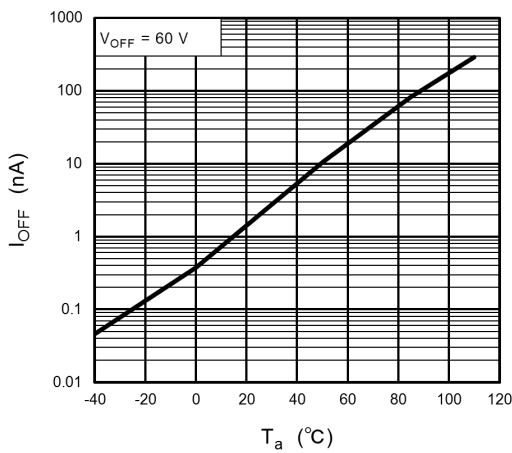

Fig. 14.1.9 $I_{OFF} - T_a$

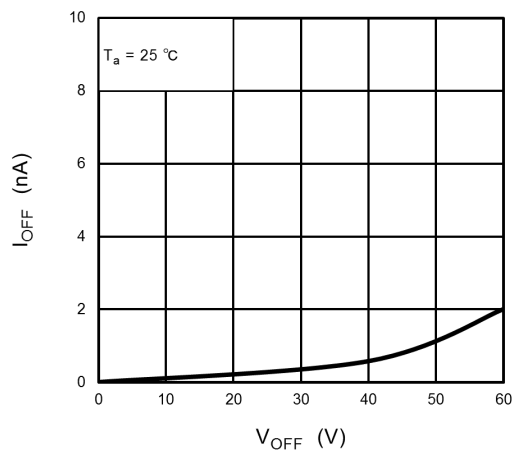

Fig. 14.1.10 $I_{OFF} - V_{OFF}$

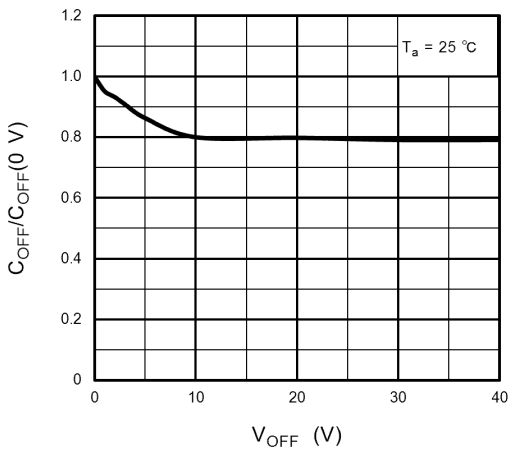

Fig. 14.1.11 $C_{OFF}/C_{OFF}(0 V) - V_{OFF}$

Note: The above characteristics curves are presented for reference only and not guaranteed by production test, unless otherwise noted.

15. Soldering and Storage

15.1. Precautions for Soldering

The soldering temperature should be controlled as closely as possible to the conditions shown below, irrespective of whether a soldering iron or a reflow soldering method is used.

- When using soldering reflow.

The soldering temperature profile is based on the package surface temperature.

(See the figure shown below, which is based on the package surface temperature.)

Reflow soldering must be performed once or twice.

The mounting should be completed with the interval from the first to the last mountings being 2 weeks.

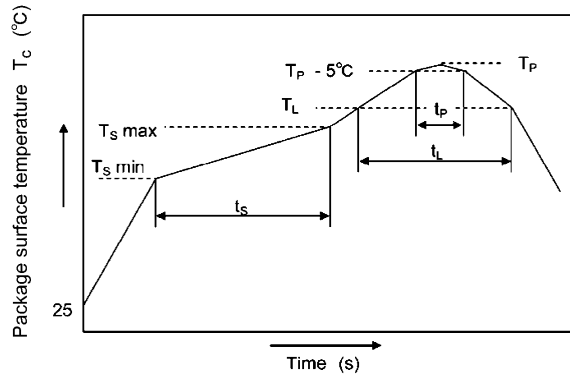

| | Symbol | Min | Max | Unit |
|--|--------|-----|-----|------|
| Preheat temperature | T_s | 150 | 200 | °C |
| Preheat time | t_s | 60 | 120 | s |
| Ramp-up rate (T_L to T_P) | | | 3 | °C/s |
| Liquidus temperature | T_L | 217 | | °C |
| Time above T_L | t_L | 60 | 150 | s |
| Peak temperature | T_P | | 260 | °C |
| Time during which T_c is between ($T_P - 5$) and T_P | t_p | | 30 | s |
| Ramp-down rate (T_P to T_L) | | | 6 | °C/s |

An Example of a Temperature Profile When Lead(Pb)-Free Solder Is Used

- When using soldering flow
Preheat the device at a temperature of 150 °C (package surface temperature) for 60 to 120 seconds.
Mounting condition of 260 °C within 10 seconds is recommended.
Flow soldering must be performed once.
- When using soldering Iron
Complete soldering within 10 seconds for lead temperature not exceeding 260 °C or within 3 seconds not exceeding 350 °C
Heating by soldering iron must be done only once per lead.

15.2. Precautions for General Storage

- Avoid storage locations where devices may be exposed to moisture or direct sunlight.
- Follow the precautions printed on the packing label of the device for transportation and storage.
- Keep the storage location temperature and humidity within a range of 5 °C to 35 °C and 45 % to 75 %, respectively.
- Do not store the products in locations with poisonous gases (especially corrosive gases) or in dusty conditions.
- Store the products in locations with minimal temperature fluctuations. Rapid temperature changes during storage can cause condensation, resulting in lead oxidation or corrosion, which will deteriorate the solderability of the leads.
- When restoring devices after removal from their packing, use anti-static containers.
- Do not allow loads to be applied directly to devices while they are in storage.
- If devices have been stored for more than two years under normal storage conditions, it is recommended that you check the leads for ease of soldering prior to use.

16. Devices in Halogen-Free Resin Packages

· This product is Halogen-Free

Toshiba Electronic Devices & Storage Corporation ("Toshiba") defines a "Halogen-Free resin semiconductor product" as a semiconductor product in which:

- (1) the encapsulating resins do not contain any of the following elements: bromine (Br), chlorine (Cl) and antimony (Sb), respectively, in an amount exceeding 0.09 weight percent, and do not contain chlorine and bromine in an aggregate amount exceeding 0.15 weight percent of the encapsulating resins, and/or
- (2) the resin portion(s) in printed circuit boards do not contain any of the following elements: bromine, chlorine and antimony, respectively, in an amount exceeding 0.09 weight percent, and do not contain chlorine and bromine in an aggregate amount exceeding 0.15 weight percent of the each resin portion(s) in printed circuit boards.

For avoidance of doubt, "Halogen-Free resin semiconductor product" does not mean, and Toshiba does not make any warranty of any kind, that said semiconductor product is entirely free of antimony or of any of the following elements of the halogen family: bromine, chlorine, iodine (I), fluorine (F) and astatine (At).

In addition, a Halogen-Free resin semiconductor product may contain antimony and/or any of the elements of the halogen family as mentioned in the above paragraph in one or more portion(s) of the semiconductor product other than the encapsulating resins and the resin portion(s) in printed circuit boards.

The information provided herein is accurate as of the date that it was provided, to the best of the knowledge and belief of the Toshiba Electronic Devices & Storage Corporation ("Toshiba"), Toshiba bases such knowledge and belief on information provided by third parties, and Toshiba makes no representation or warranty as to the accuracy of such third party information. Toshiba has taken and will continue to take, reasonable steps to provide accurate information to its customers, but may not have conducted destructive testing or chemical analysis on incoming materials and chemicals.

17. Ordering Information (Example of Item Name)

| Item Name | Packaging (Note 1) | VDE Option | Packing (MOQ) |
|-------------------|--------------------|------------|--------------------------|
| TLP3122A(E) | SMD | | Magazine (125 pcs) |
| TLP3122A(TPL,E) | SMD | | Tape and reel (3000 pcs) |
| TLP3122A(TPR,E) | SMD | | Tape and reel (3000 pcs) |
| TLP3122A(V4,E) | SMD | EN 60747 | Magazine (125 pcs) |
| TLP3122A(V4TPL,E) | SMD | EN 60747 | Tape and reel (3000 pcs) |
| TLP3122A(V4TPR,E) | SMD | EN 60747 | Tape and reel (3000 pcs) |

Note 1: SMD: Surface Mount Device

Package Dimensions

Unit: mm

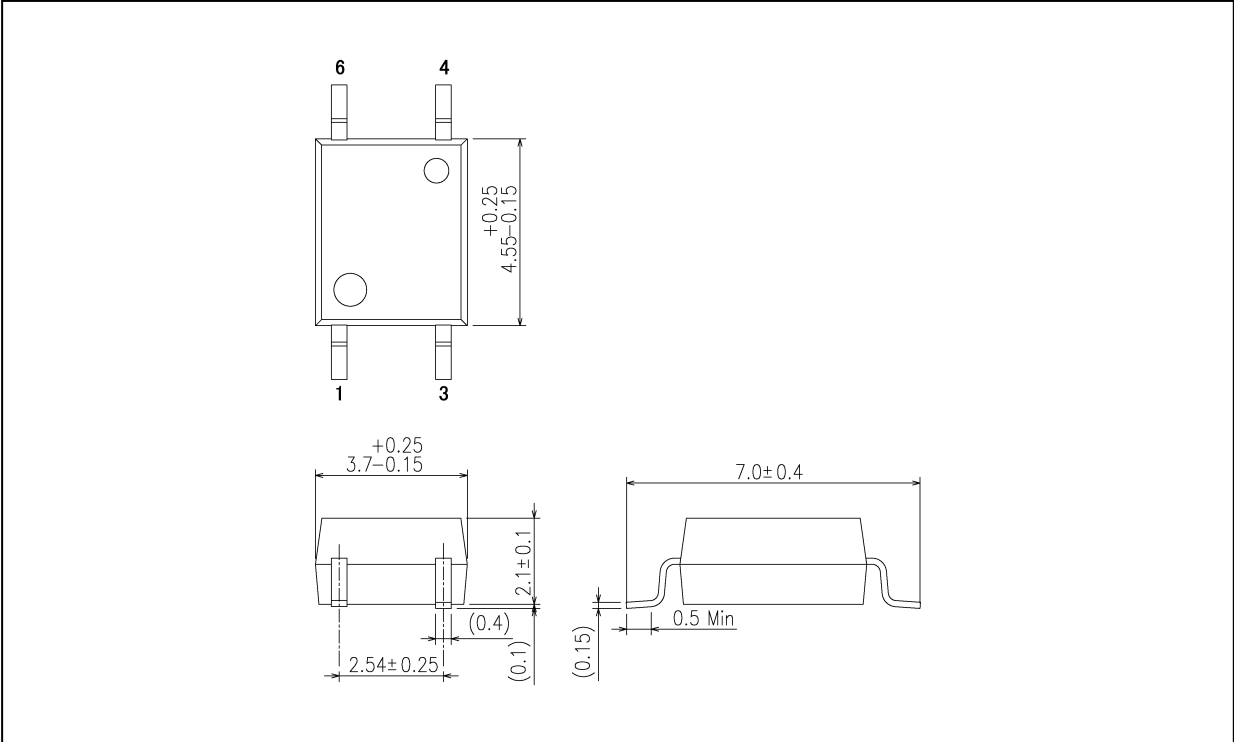

Weight: 0.1 g (typ.)

| Package Name(s) |
|------------------|
| TOSHIBA: 11-4M1S |

RESTRICTIONS ON PRODUCT USE

Toshiba Corporation and its subsidiaries and affiliates are collectively referred to as "TOSHIBA".

Hardware, software and systems described in this document are collectively referred to as "Product".

- TOSHIBA reserves the right to make changes to the information in this document and related Product without notice.
- This document and any information herein may not be reproduced without prior written permission from TOSHIBA. Even with TOSHIBA's written permission, reproduction is permissible only if reproduction is without alteration/omission.
- Though TOSHIBA works continually to improve Product's quality and reliability, Product can malfunction or fail. Customers are responsible for complying with safety standards and for providing adequate designs and safeguards for their hardware, software and systems which minimize risk and avoid situations in which a malfunction or failure of Product could cause loss of human life, bodily injury or damage to property, including data loss or corruption. Before customers use the Product, create designs including the Product, or incorporate the Product into their own applications, customers must also refer to and comply with (a) the latest versions of all relevant TOSHIBA information, including without limitation, this document, the specifications, the data sheets and application notes for Product and the precautions and conditions set forth in the "TOSHIBA Semiconductor Reliability Handbook" and (b) the instructions for the application with which the Product will be used with or for. Customers are solely responsible for all aspects of their own product design or applications, including but not limited to (a) determining the appropriateness of the use of this Product in such design or applications; (b) evaluating and determining the applicability of any information contained in this document, or in charts, diagrams, programs, algorithms, sample application circuits, or any other referenced documents; and (c) validating all operating parameters for such designs and applications.
TOSHIBA ASSUMES NO LIABILITY FOR CUSTOMERS' PRODUCT DESIGN OR APPLICATIONS.

- **PRODUCT IS NEITHER INTENDED NOR WARRANTED FOR USE IN EQUIPMENTS OR SYSTEMS THAT REQUIRE EXTRAORDINARILY HIGH LEVELS OF QUALITY AND/OR RELIABILITY, AND/OR A MALFUNCTION OR FAILURE OF WHICH MAY CAUSE LOSS OF HUMAN LIFE, BODILY INJURY, SERIOUS PROPERTY DAMAGE AND/OR SERIOUS PUBLIC IMPACT ("UNINTENDED USE").**

Except for specific applications as expressly stated in this document, Unintended Use includes, without limitation, equipment used in nuclear facilities, equipment used in the aerospace industry, lifesaving and/or life supporting medical equipment, equipment used for automobiles, trains, ships and other transportation, traffic signaling equipment, equipment used to control combustions or explosions, safety devices, elevators and escalators, and devices related to power plant.

IF YOU USE PRODUCT FOR UNINTENDED USE, TOSHIBA ASSUMES NO LIABILITY FOR PRODUCT.

For details, please contact your TOSHIBA sales representative or contact us via our website.

- Do not disassemble, analyze, reverse-engineer, alter, modify, translate or copy Product, whether in whole or in part.
- Product shall not be used for or incorporated into any products or systems whose manufacture, use, or sale is prohibited under any applicable laws or regulations.
- The information contained herein is presented only as guidance for Product use. No responsibility is assumed by TOSHIBA for any infringement of patents or any other intellectual property rights of third parties that may result from the use of Product. No license to any intellectual property right is granted by this document, whether express or implied, by estoppel or otherwise.
- **ABSENT A WRITTEN SIGNED AGREEMENT, EXCEPT AS PROVIDED IN THE RELEVANT TERMS AND CONDITIONS OF SALE FOR PRODUCT, AND TO THE MAXIMUM EXTENT ALLOWABLE BY LAW, TOSHIBA (1) ASSUMES NO LIABILITY WHATSOEVER, INCLUDING WITHOUT LIMITATION, INDIRECT, CONSEQUENTIAL, SPECIAL, OR INCIDENTAL DAMAGES OR LOSS, INCLUDING WITHOUT LIMITATION, LOSS OF PROFITS, LOSS OF OPPORTUNITIES, BUSINESS INTERRUPTION AND LOSS OF DATA, AND (2) DISCLAIMS ANY AND ALL EXPRESS OR IMPLIED WARRANTIES AND CONDITIONS RELATED TO SALE, USE OF PRODUCT, OR INFORMATION, INCLUDING WARRANTIES OR CONDITIONS OF MERCHANTABILITY, FITNESS FOR A PARTICULAR PURPOSE, ACCURACY OF INFORMATION, OR NONINFRINGEMENT.**
- GaAs (Gallium Arsenide) is used in Product. GaAs is harmful to humans if consumed or absorbed, whether in the form of dust or vapor. Handle with care and do not break, cut, crush, grind, dissolve chemically or otherwise expose GaAs in Product.
- Do not use or otherwise make available Product or related software or technology for any military purposes, including without limitation, for the design, development, use, stockpiling or manufacturing of nuclear, chemical, or biological weapons or missile technology products (mass destruction weapons). Product and related software and technology may be controlled under the applicable export laws and regulations including, without limitation, the Japanese Foreign Exchange and Foreign Trade Law and the U.S. Export Administration Regulations. Export and re-export of Product or related software or technology are strictly prohibited except in compliance with all applicable export laws and regulations.
- Please contact your TOSHIBA sales representative for details as to environmental matters such as the RoHS compatibility of Product. Please use Product in compliance with all applicable laws and regulations that regulate the inclusion or use of controlled substances, including without limitation, the EU RoHS Directive. **TOSHIBA ASSUMES NO LIABILITY FOR DAMAGES OR LOSSES OCCURRING AS A RESULT OF NONCOMPLIANCE WITH APPLICABLE LAWS AND REGULATIONS.**