

Weller®



WHA 3000P Hot Air Station Operating Instructions

Version 2.3

Weller®

Weller Tools GmbH
Carl-Benz-Str. 2, 74354 Besigheim, Germany
Tel: +49 (0) 7143 580- 0, Fax: +49 (0) 7143 580- 108

Table of contents	Page
1. Description	5
Technical data	5
2. Placing in operation	6
2.1 Manual operating mode	6
2.2 Automatic operating mode	7
2.3 Setting temperature profile	8
2.4 Starting program	8
2.5 Control of the vacuum function	9
2.6 Saving and loading temperature-time profiles	9
3. External sensor	10
3.1 External sensor with measuring function "MEASURE MODE" (factory setting)	10
3.2 Teach In Mode procedure	10
3.3 External sensor with control function "CONTROL MODE"	10
4. Lock Mode	11
5. Switching Temperature Conversion	11
6. RS232 Interface	11
7. Work Instructions	11
8. Maintenance	11
9. Error Messages	12
10. Accessories	12
11. Items Supplied	12
12. Hot Air Nozzles	13
13. Quick Reference	14

Operating instructions WHA 3000P

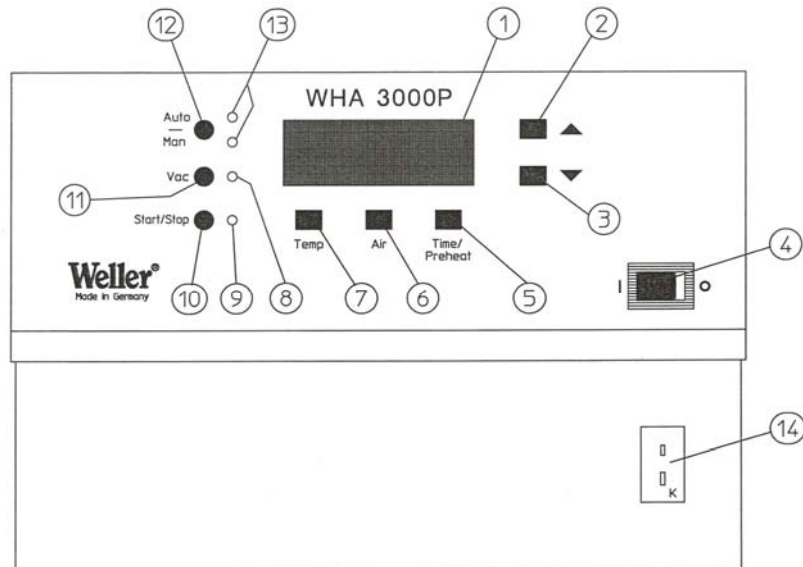

Front view WHA3000P

- 1 LCD Display
- 2 "UP" Control Key
- 3 "DOWN" Control Key
- 4 Mains Switch
- 5 "TIME"/"PREHEAT" Control Key (time setting auto. mode / pre-heating temperature)
- 6 "AIR" Control Key (air flow rate)
- 7 "TEMP" Control Key (hot air temperature)
- 8 LED Indicator, Vacuum
- 9 LED Indicator, START/STOP
- 10 "START/STOP" Control Key
- 11 "VAC" Control Key (activate Vacuum)
- 12 "AUTO" – "MAN" Control Key (changeover Automatic – Manual operating mode)
- 13 LED Indicators, Auto-Man operating mode
- 14 Connection for External Sensor Type K

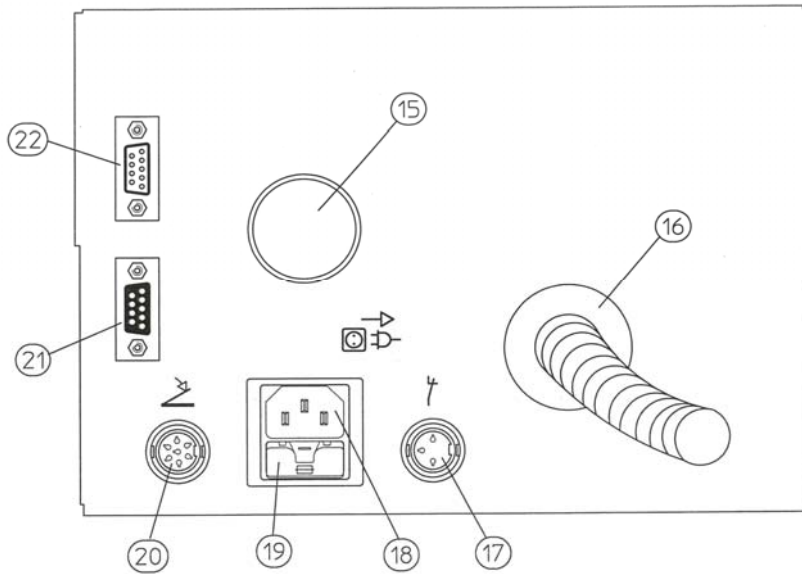

Rear view WHA3000P

- 15 Vacuum Pump Filter
- 16 Hand-piece Connecting Hose
- 17 Stand Switch Connection
- 18 Mains Connection
- 19 Mains Fuse
- 20 Connection for Manual Control Console; Foot Switch
- 21 PC Interface, RS232
- 22 Connection for WHP3000 (bottom heater), RS232 Interface

We thank you for the confidence you have shown by purchasing the **Weller WHA 3000P Hot Air Station**. During manufacturing, the strictest quality requirements are applied; these assure the correct function of the device and make it possible to obtain optimal soldering results.



Warning!

Prior to placing the device in operation, please carefully read these operating instructions and the safety instructions enclosed. If the safety instructions are not observed, there is a risk of injury.

The manufacturer accepts no liability for usage other than that described in the operating instructions or for unauthorized modifications

The WELLER WHA 3000P Hot Air Station complies with the EU declaration of conformity as per the essential safety requirements in the directives 2004/108/EC and 2006/95/EC

1. Description

The WHA 3000P Hot Air Station is suitable for difficult repairs on circuit boards with FINEPITCH components. A thorough design concept combines maximum process safety with ease of use and technically advanced application solutions. A comprehensive range of accessories adds to the possible uses of this repair workstation.

The hot air temperature at the hand-piece can be adjusted over the range of 50°C – 550°C (150°F – 999°F). The air flow rate is generated via an internal turbine and can be adjusted between the range of 5 l/min – 50 l/min. Hot air temperature and air flow rate are digitally controlled.

The vacuum necessary for lifting the component is integrated into the nozzle system and can be activated to suit the operating mode chosen. Two operating modes are provided:

- A The "Manual" operating mode (MAN) can be used for manual work at the hot air temperature and air flow rate set. Hot air and vacuum can be activated using the foot switch, manual remote control console or directly on the control Panel.
- B The "Automatic" operating mode (AUTO) establishes a program with a 3-step time/temperature profile, and can be used in conjunction with the WHP 3000 Pre-Heat Plate available as an accessory.

The parameters for hot air temperature, air flow rate, temperature of the optional WHP 3000 Pre-Heat Plate and vacuum function can be adjusted separately and can be saved as a Rework Profile for the specific application.

The repair station can also be complemented with the optional matched WBH 3000S Circuit Board Holder for X-Y alignment and a stand with Z-axis guide for the hot air hand-piece.

Technical data

Dimensions (W X L X H):	240 (9.44) X 270 (10.63) X 170 (6.69) mm (inch)
Mains voltage:	230 V (120 V) AC
Power consumption:	600 W
Air flow rate:	5 – 50 l/min
Temperature range:	50°C –550°C (150°F – 999°F)
Accuracy:	+/- 30°C (+/- 54°F)
Vacuum:	- 0.6 bar
Mains fuse:	230 V / T6.3A (120 V / T8 A)
Protection class:	1 (Control Unit and Hand-Piece are hard grounded)

2. Placing in operation

Place the hand-piece, with the hot air nozzle installed, in the AKT30 safety stand. (The device cannot be placed in operation without the safety stand or optional WBH 3000S Circuit Board Holder.) Plug cable from safety stand or optional WBH 3000S Circuit Board Holder (proximity switch), into socket (17). Check whether the mains voltage matches the information on the rating plate. If the mains voltage is correct, connect the controller to the mains. When the device is switched on, the device name "**WHA 3000**" and the software "**Version**" are displayed briefly. The electronics then switch automatically to the default setting (Manual operating mode).

2.1 Manual operating mode

Information on display (1)

	TEMP	AIR	PREHEAT
	350°C	25 l	OFF

↑ ↑ ↑

Nozzle Air Nozzle
Temp. Flow Rate Pre-Heating
in °C/°F in l/min ON/OFF

In the Manual operating mode the parameters for the nozzle temperature, air flow rate and switching on or off the pre-heating can be set.

Select the parameter by pressing the Control Key:

- **TEMP** (7): Nozzle temperature in °C/°F
(see Switching Temperature Conversion page 11)
- **AIR** (6): Air flow rate in l/min
- **TIME/**
PREHEAT (5): Switch ON - OFF the nozzle pre-heating (standby) at 200°C/392°F with 5 l/min airflow

After selection, the setting can be changed using the **UP** (2) or **DOWN** (3) Control Keys. Keeping the Control Key depressed, rapidly changes the value.

The hot air and the nozzle vacuum are activated:

Directly on the Control Panel: Hot air **START/STOP** Control Key (10), Vacuum **VAC** Control Key (11)

2-Position Foot Switch (20):	Hot air-Position 1, Vacuum-Position 2 (hot air and vacuum are only active in the Manual Mode, when the Foot Switch is depressed)
Manual Control Console (20): (Optional)	Hot Air " AIR " Control Key, Vacuum " VAC " Control Key

When the hand-piece is placed in the AKT30 Safety Stand (17), the hot air is switched off by a Mirco Switch. If the nozzle pre-heating is active (PREHEAT ON), the device switches to the standby mode with reduced temperature and air flow rate (200°C / 392°F – 5l/min).

Note: Hot air is automatically disabled after 999 sec for safety reasons.

2.2 Automatic operating mode

The Automatic operating mode has a 3-step temperature-time profile.

The temperature-time profile can be expanded by connecting an optional WHP 3000 bottom heater. When the WHP 3000 is connected via the RS232 interface (22) the bottom heater is integrated into the time profile.

The temperature profile is comprised of the following 3-steps:

Pre-heat phase, system	Step 1	(ends with an audible tone)
Pre-heat phase, component	Step 2	
Reflow process (soldering)	Step 3	

The soldering process is normally started with the hot gas nozzle raised. At the end of step 1 there is an audible tone, after this tone the nozzle should be placed over the component in the soldering position. At the end of Step 3, raise or remove the nozzle from the application.

The following pre-settings must be made on the WHA 3000P controller to define a customer-specific temperature-time profile.

Settings step 1 – step 3

Nozzle temperature	50°C – 550°C (150°F / 999°F)
Temperature, bottom heat	50°C – 400°C (150°F / 750°F) (optional with WHP 3000)
Air flow rate	5 l/min – 50 l/min
Time for the program step	0 sec. – 999 sec.

The Automatic operating mode can be selected by pressing the **AUTO/MAN** Control Key. The light emitting diodes (LED's) (13) indicate the related operating state.

Information on the display (1)

	TEMP	AIR	TIME	
Nozzle	210°C	40 l	100s	step 1
Pre-Heater	300°C	25 l	50s	step 2
Nozzle	210°C	30 l	15s	step 3

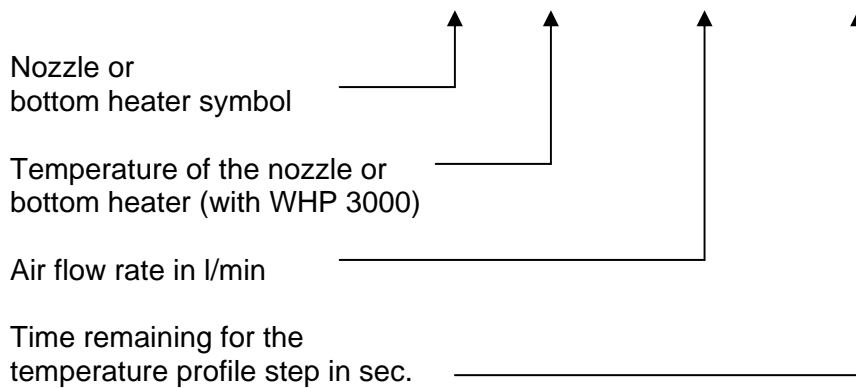

2.3 Setting temperature profile

Select the parameters by pressing the Control Key:

- **TEMP (7):** Depressed Once : Nozzle temperature during the first step
Depressed Twice : Temperature of the bottom heater during the first step
(only with WHP 3000)

↓ Repeat for Steps 1-3

Symbol for nozzle or bottom heater indicates which temperature is displayed.

- **AIR (6):** Depressed Once: Air flow rate in l/min during the first step

↓ Repeat for Steps 1-3

- **TIME/ PREHEAT (5) :** Depressed Once: time remaining in the first step

↓ Repeat for Steps 1-3

The active value is marked on the display and can be changed using the **UP / DOWN (2) / (3)** Control Keys. Keeping the Control Key depressed, rapidly changes the value.

2.4 Starting program

The soldering process and thus the 3-step temperature-time profile is started:

- Directly on the Control Panel: **START/STOP** (10) Control Key, LED (9) illuminates.
- 2-Position Foot Switch (20): **START/STOP** corresponds to setting 1 of the foot switch
(hot air and vacuum are only active when pressed)
Foot Switch Position 1-Air, Position 2-Vacuum
- Manual Control Console (20): **START/STOP** using the **AIR** Control Key
(Optional)

The nozzle temperature, air flow rate and the time remaining are indicated on the display (1). The active program step is marked on the display.

When the hand-piece is placed in the safety stand, the program is interrupted and the hot air switched off by an integrated contact. When the nozzle pre-heating is active (PREHEAT ON), the device switches to the standby mode with reduced temperature and air flow rate.

Note: When using the WBH 3000S Circuit Board Holder (17), the WHA 3000P will automatically turn “off” if the position of the Z-axis Head is moved from the “Locked” center position. It must remain in position directly over the Hot Plate to allow for the WHA 3000P to operate.

2.5 Control of the vacuum function

The nozzle vacuum are activated:

- Directly on the Control Panel: **VAC** (11) Control Key, LED (8) illuminates.
- 2-Position Foot Switch (20): vacuum corresponds to Position 2 of the foot switch
- Manual Control Console (20): using the VAC Control Key
(Optional)

If the **VAC** Control Key (11) is pressed prior to the start of a de-soldering process, the vacuum integrated into the nozzle is activated automatically at the end of the process. The vacuum function can also be enabled and disabled manually at any time during the soldering process. If the vacuum is enabled during a soldering process, there is no automatic activation at the end of the process.

Note: If the nozzle temperature is above 250°C/482°F the vacuum is automatically disabled after 90 sec for safety reasons.

2.6 Saving and loading temperature-time profiles

A total of 10 temperature-time profiles can be saved. A default profile is saved in the 10 program memories in the factory.

Press **UP/DOWN** Control Keys (2)/(3) simultaneously until the following menu appears on the display (1)

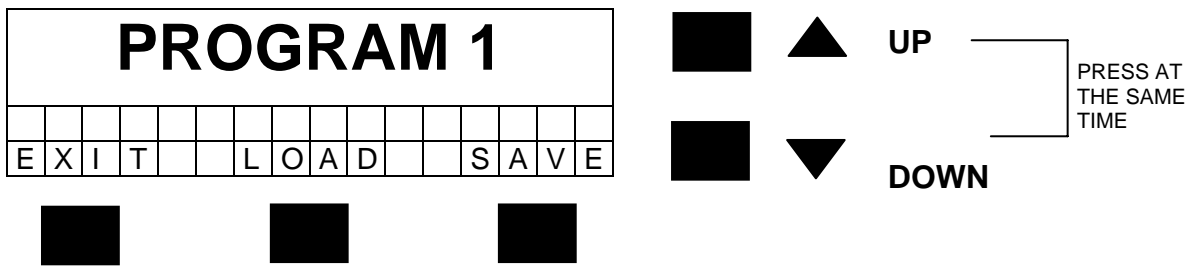

The program memories 1 - 10 can be selected using the **UP/DOWN** Control Keys (2)/(3).

The preferred program can be selected by pressing the **LOAD** Control Key (6).

The indication on the display changes to the automatic mode and displays the selected parameters.

If a temperature-profile has been prepared, it can be saved in the selected program memory by pressing the **SAVE** Control Key (5).

The menu can be exited without saving any changes using the **EXIT** Control Key (7).

3. External Sensor

When using an external sensor (Thermocouple Type K), two different operating modes are available. By pressing the Control Key "TIME" / "PREHEAT" (5) when switching on the unit (4), you can toggle between the operating modes "MEASURE MODE" and "CONTROL MODE". The following appears briefly in the display (1):

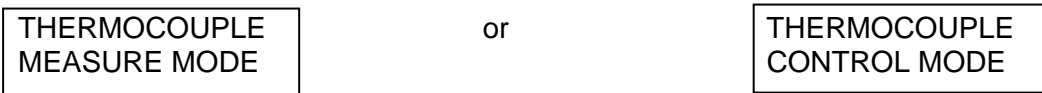

Both operating modes only become active once the external sensor (14) has been connected.

3.1 External Sensor with measuring function "MEASURE MODE" (factory setting)

In this operating mode, the external sensor only has a measuring function. The temperature of the external sensor is shown in the display (1). The Hot Air Tool temperature control regulates the setpoint value for the nozzle temperature.

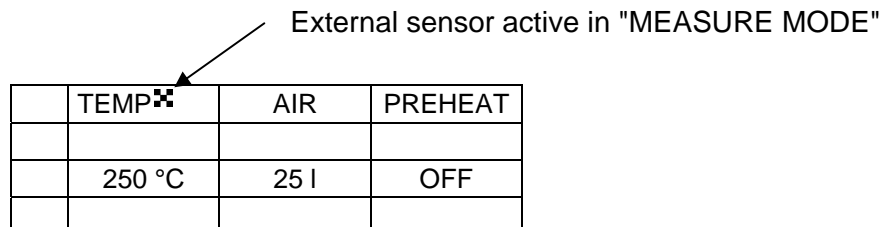

3.2 Teach In Mode procedure

During the sequence of an automatic temperature-time profile, it is possible to continue switching the process stages 1-3 manually by pressing the Control Key "TIME" / "PREHEAT" (5). If the external sensor is suitably positioned on the assembly or component, its temperature can be monitored during the entire process sequence and can be continued to be switched when the desired specified temperatures (stage 1-3) have been reached. The times determined in this manner are shown after the soldering or desoldering process in the display (1) and can be saved.

3.3 External sensor with control function "CONTROL MODE"

The temperature of the external sensor is controlled in this operating mode. The external sensor records the actual value (control variable) for the temperature control. The setting for the setpoint value at the unit must therefore be adapted to the measured temperature (actual value) of the external sensor. The actual value of the external sensor is shown in the display (1).

External sensor active in "CONTROL MODE"



	TEMP	AIR	PREHEAT
	250 °C	25 l	OFF

A basic prerequisite for faultless application is direct contact of the sensor on the assembly or component.

4. Lock Mode

The device can be locked by inserting and removing a coded plug in socket (20). The current soldering parameters cannot be further changed. The WHA 3000P can only be operated using the START/STOP (10) and VAC (11) Control Keys.

5. Switching Temperature Conversion

By pressing the Control Key "Temp" (7) when switching on the unit (4), you can toggle between the operating modes "°C" and "°F". The following appears briefly in the display (1):

°C

or

°F

6. RS232 interface

Using additional software, the device can be operated completely via the RS232 interface (21).

7. Work instructions

The hot air nozzle is designed such that the vacuum plate lies flat on the component. The vacuum plate is also used for the transfer of heat. When the vacuum is enabled, the component can be lifted after the solder has reflowed. Here it is important to pre-heat the vacuum plate to operating temperature prior to de-soldering. As an option, it is possible to use a vacuum cup in place of the vacuum plate.

Nozzle change

Caution: Risk of burns! The hot air nozzle remains hot for some time after power off or removal.

The hot air nozzles are fastened to the heating element using a clamping screw. To change the nozzle, loosen the screw and remove the hot gas nozzle using the Nozzle Change Tool provided.

8. Maintenance

The vacuum filter (15) is soiled by flux residues and contaminants and must be replaced if the vacuum drops.

9. Error messages

Error	Description	Rectification
ERROR 75	Offset entry on heating element change incorrect	Repeat process
ERROR 76	Heating element faulty	Replace heating element
ERROR 110	WHP3000 housing temperature exceeded	Allow to cool down
REMOTE LOCKED	Input inhibited (can only be operated using PC) WHA locked (lock function)	Operate using PC Unlock WHA
TOOL STAND	AKT30 Stand (or WBH3000 Proximity Sensor) not connected	Connect to socket (17)

10. Accessories

0053119099	External sensor type K Ø 0.5mm
0058754951	External sensor type K Ø 0.25mm
0058757770	Foot switch
0058736780	Manual Control Console
0051504899	Stand for six hot air nozzles
WBH3000	Circuit board holder
WBH3000S	Circuit board holder with hot air tool stand
WHP3000	Bottom heating plate

11. Items supplied

WHA3000P Controller with hand-piece
AKT30 Safety stand
0051504999 Nozzle exchange tool
Coded plug
Tool kit (2,5 mm hex wrench w/2 3 mm x 6 mm L screws provided)
0058750721 Hot air nozzle NQ30
Main power cord 120VAC
0058757770 Foot switch (Only USA Version)
Product CD- Rom (Operating instructions incl. WHA control software)
Subject to technical change without notice!

12. Hot Air Nozzles

Hot Air Nozzles for HAP 3

Round Nozzles

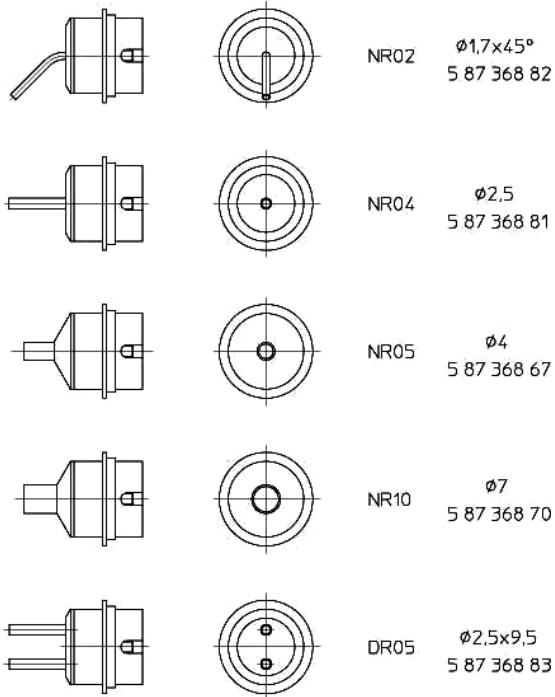

4D9R304-A-2

Hot air nozzles 4-sides heated (Type NQ))

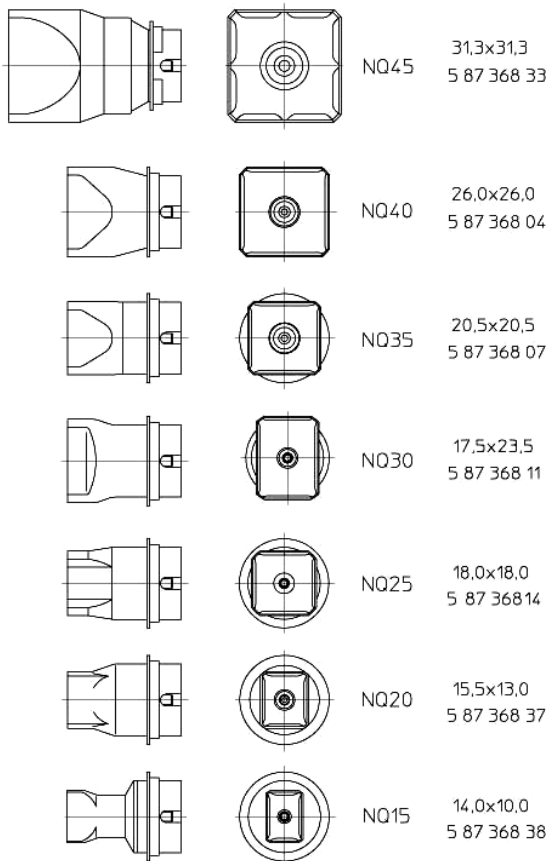

4D9R304-A-2

Hot air nozzles 2-sides heated (Type ND)

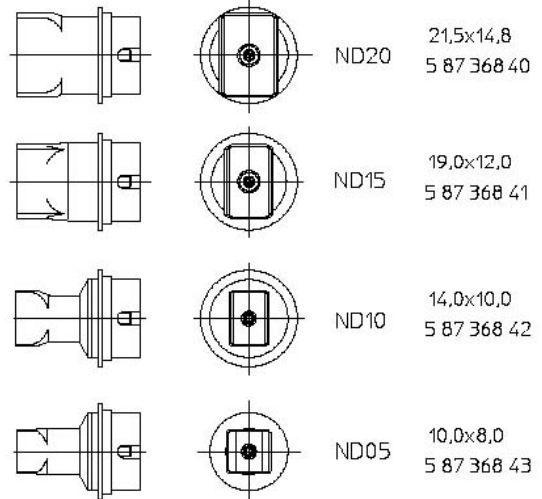



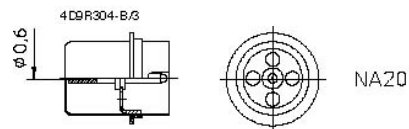











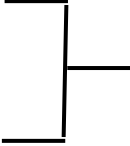

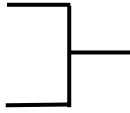

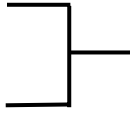

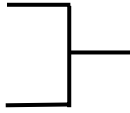
Measuring nozzle 005 87 368 75



005 87 368 39 NQT Hot air nozzle 22,0 x 22,0 mm
 005 87 368 41 NQT10 Hot air nozzle 14,8 x 14,8 mm
 005 87 368 42 NQT25 Hot air nozzle 18,0 x 18,0 mm
 005 87 368 43 NQT Hot air nozzle 16,0 x 16,0 mm

13. Quick Reference WHA3000P/V

- Changeover auto-manual operating mode Auto Man 
- UP Control Key increase value  
- DOWN Control Key decrease value  
- Activating vacuum function Vac 
- Start/Stop soldering process
Respectively hot air function Start/Stop 
- Setting hot air temperature (manual mode)  Temp 
- Setting hot air temperature and bottom heater for step 1 – 3 (auto mode)  Air 
- Setting flow rate (manual mode)  Air 
- setting flow rate for step 1 – 3 (auto mode)  Air 
- Time setting for step 1 – 3 (auto mode) Time / Preheat 
- Nozzle preheating ON/OFF (manual mode) Time / Preheat 
- Save and load program for temperature profiling  
+
  } Program
- Switching Temperature Conversion (Pressing when switching on the WHA 3000P) Temp 