

SRV05-4HTG-D

6V 10A TVS Diode Array

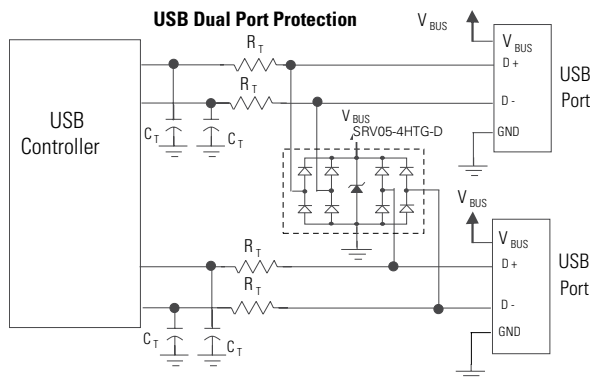

Application Examples



10/100/1000 Ethernet Protection

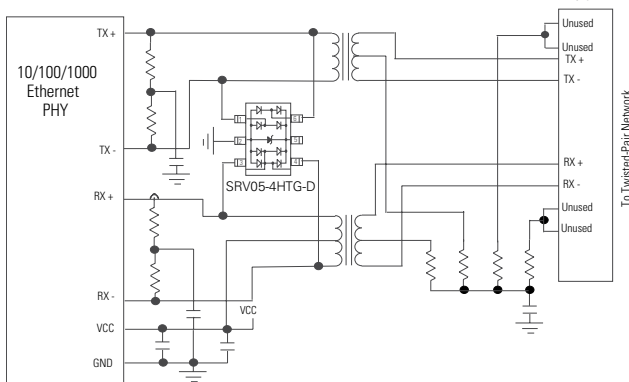

Description

The SRV05-4HTG-D integrates low capacitance rail-to-rail diodes with an additional zener diode to protect each I/O pin against ESD and high surge events. This robust device can safely absorb 10A surge current per IEC 61000-4-5, 2nd Edition (tP=8/20µs) without performance degradation and a minimum ±30kV ESD per IEC 61000-4-2. Their very low loading capacitance also makes them ideal for protecting high speed signal pins.

Features and Benefits

- ESD, IEC 61000-4-2, ±30kV contact, ±30kV air
- EFT, IEC61000-4-4, 40A
- Lightning, IEC 61000-4-5 2nd Edition, 10A (8/20µs)
- Low capacitance of 1pF (TYP) per I/O
- Low leakage current of 0.5µA (MAX) at 5V
- Small SOT23-6 (JEDEC MO-178) packaging
- Halogen free, lead free and RoHS compliant
- Moisture Sensitivity Level (MSL -1)

Applications

- LCD/PDP TVs
- Monitors
- Notebooks
- 10/100/1000 Ethernet
- Firewire
- Set Top Boxes
- Flat Panel Displays
- Portable Medical

Pinout

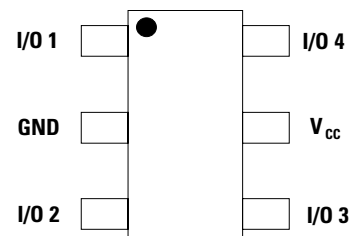

Top View

Functional Block Diagram

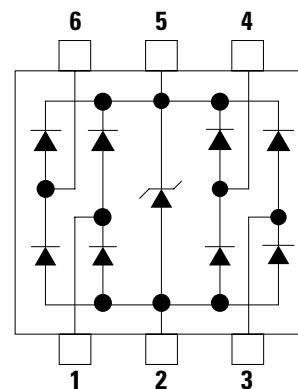

Life Support Note:

Not Intended for Use in Life Support or Life Saving Applications

The products shown herein are not designed for use in life sustaining or life saving applications unless otherwise expressly indicated.

SRV05-4HTG-D

6V 10A TVS Diode Array

Absolute Maximum Ratings

Symbol	Parameter	Value	Units
I_{PP}	Peak Current ($t_p=8/20\mu s$)	10	A
P_{PK}	Peak Pulse Power ($t_p=8/20\mu s$)	150	W
T_{OP}	Operating Temperature	-40 to 125	°C
T_{STOR}	Storage Temperature	-55 to 150	°C

Caution: Stresses above those listed in "Absolute Maximum Ratings" may cause permanent damage to the component. This is a stress only rating and operation of the component at these or any other conditions above those indicated in the operational sections of this specification is not implied.

Electrical Characteristics ($T_{OP}=25^\circ C$)

Parameter	Symbol	Test Conditions	Min	Typ	Max	Units
Reverse Standoff Voltage	V_{RWM}	-			6	V
Breakdown Voltage	V_{BR}	$I_R = 1mA$, I/O to GND	6	8.5		V
Reverse Leakage Current	I_{LEAK}	$V_R=5V$, I/O to GND		0.1	0.5	μA
Clamp Voltage ¹	V_C	$I_{PP}=5A$, $t_p=8/20\mu s$, I/O to GND		11.7	13	V
		$I_{PP}=8A$, $t_p=8/20\mu s$, I/O to GND		12.5	14	V
		$I_{PP}=10A$, $t_p=8/20\mu s$, I/O to GND		13.2	15	V
Dynamic Resistance ²	R_{DYN}	TLP, $t_p=100ns$, I/O to GND		0.28		Ω
ESD Withstand Voltage ¹	V_{ESD}	IEC 61000-4-2 (Contact Discharge)	± 30			kV
		IEC 61000-4-2 (Air Discharge)	± 30			kV
Diode Capacitance ¹	$C_{I/O-GND}$	Reverse Bias=0V, $f=1MHz$, I/O to GND		1	3	pF
	$C_{I/O-I/O}$	Reverse Bias=0V, $f=1MHz$, I/O to I/O		0.5		pF

Notes:

1. Parameter is guaranteed by design and/or component characterization.

2. Transmission Line Pulse (TLP) test setting : Std.TDR(50 Ω), $t_p=100ns$, $t_r=0.2ns$ ITLP and VTLP averaging window: start $t_1=70ns$ to end $t_2=80ns$

8/20 μs Pulse Waveform

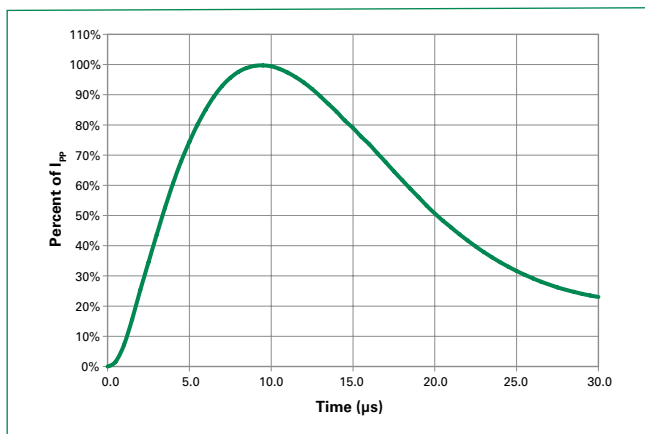

Capacitance vs. Reverse Bias

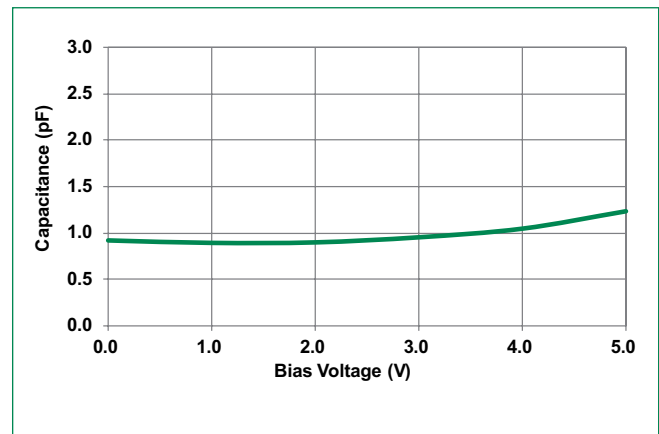

SRV05-4HTG-D

6V 10A TVS Diode Array

Positive Transmission Line Pulsing (TLP) Plot

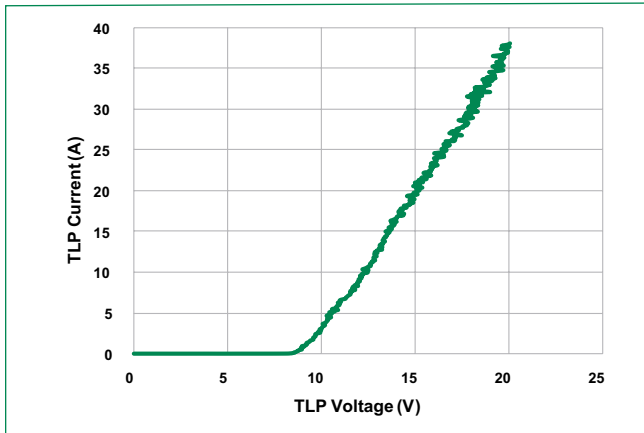

Negative Transmission Line Pulsing (TLP) Plot

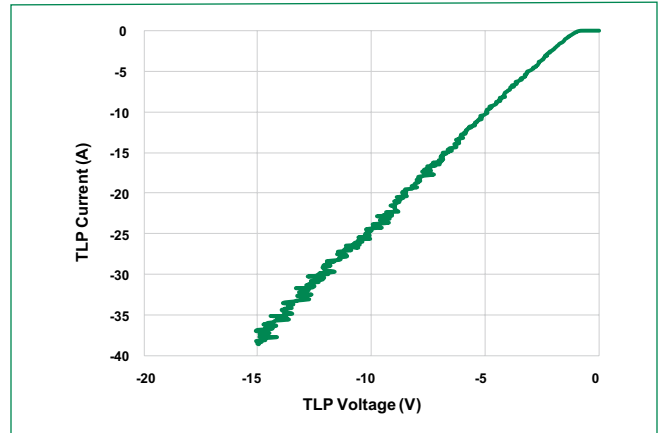

Clamping Voltage vs. Peak Pulse Current

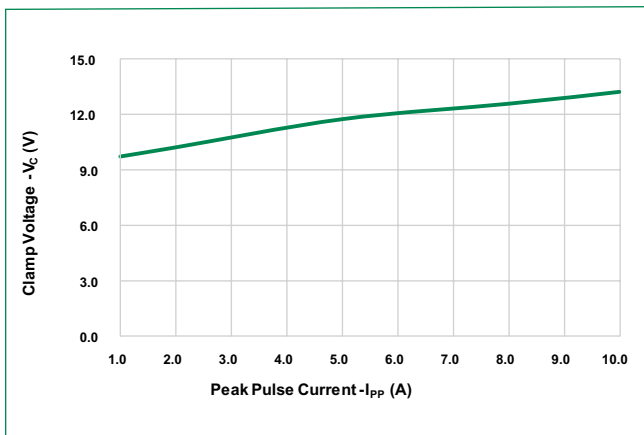

IEC 61000-4-2 +8 kV Contact ESD Clamping Voltage

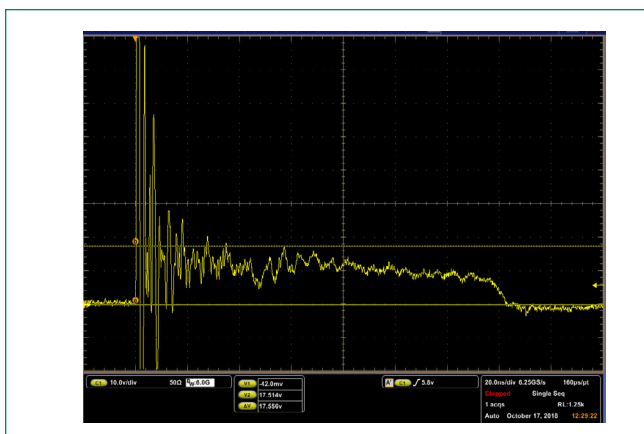

IEC 61000-4-2 -8 kV Contact ESD Clamping Voltage



SRV05-4HTG-D

6V 10A TVS Diode Array

Soldering Parameters

Reflow Condition		Pb – Free assembly
Pre Heat	- Temperature Min ($T_{s(min)}$)	150°C
	- Temperature Max ($T_{s(max)}$)	200°C
	- Time (min to max) (t_s)	60 – 120 secs
Average ramp up rate (Liquidus) Temp (T_L) to peak		3°C/second max
$T_{s(max)}$ to T_L - Ramp-up Rate		3°C/second max
Reflow	- Temperature (T_L) (Liquidus)	217°C
	- Temperature (t_L)	60 – 150 seconds
Peak Temperature (T_p)		260 ^{+0/-5} °C
Time within 5°C of actual peak Temperature (t_p)		30 seconds
Ramp-down Rate		6°C/second max
Time 25°C to peak Temperature (T_p)		8 minutes Max.
Do not exceed		260°C

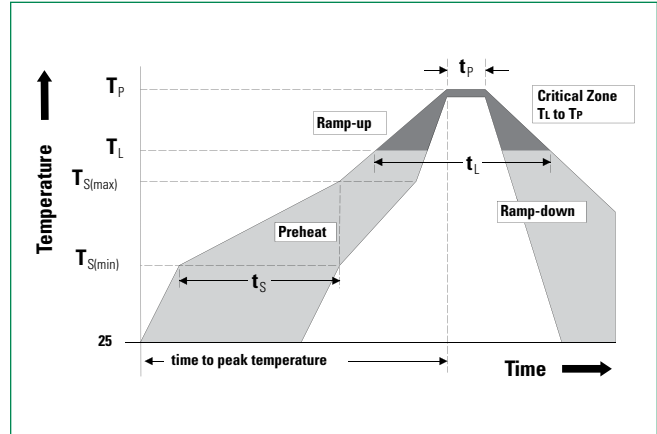

Ordering Information

Part Number	Package	Min. Order Qty.
SRV05-4HTG-D	SOT23-6	3000

Product Characteristics

Lead Plating	Matte Tin
Lead Material	Copper Alloy
Lead Coplanarity	0.004 inches(0.102mm)
Substrate Material	Silicon
Body Material	Molded Compound
Flammability	UL Recognized compound meeting flammability rating V-0

Part Marking System

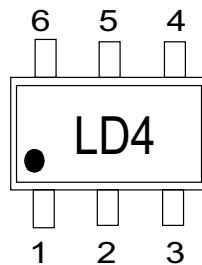

L : Part code
D : Assembly code
4 : Number of channel

Part Numbering System

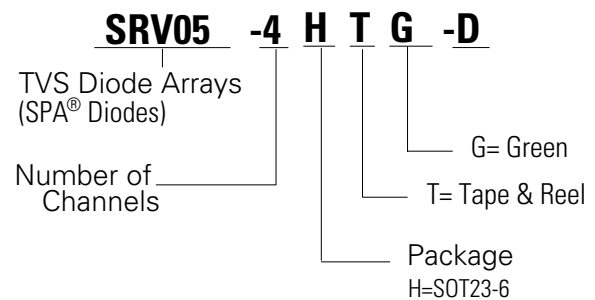

SRV05-4HTG-D

6V 10A TVS Diode Array

Package Dimensions - SOT23-6

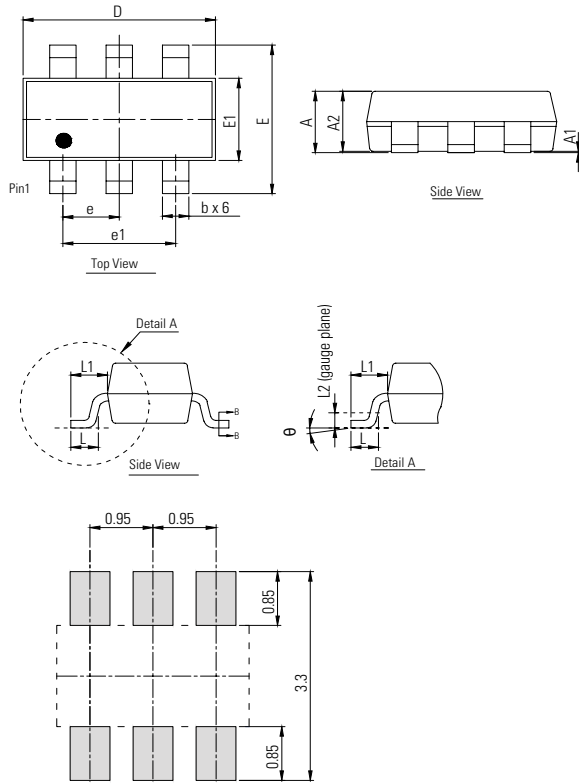

Symbol	Millimeters			Inches		
	Min	Nom	Max	Min	Nom	Max
A	-	-	1.45	-	-	0.057
A1	0.00	-	0.15	0.000	-	0.006
A2	0.90	1.15	1.30	0.035	0.045	0.051
D	2.70	2.90	3.05	0.106	0.114	0.120
E	2.60	2.80	3.00	0.102	0.110	0.118
E1	1.45	1.60	1.75	0.057	0.063	0.069
e	0.95 BSC			0.037 BSC		
e1	1.90 BSC			0.075 BSC		
L	0.30	0.50	0.60	0.012	0.020	0.024
L1	0.60 REF			0.024 REF		
L2	0.25 BSC			0.010 BSC		
θ	0°	4°	8°	0°	4°	8°

Embossed Carrier Tape & Reel Specification – SOT23-6

8mm TAPE AND REEL

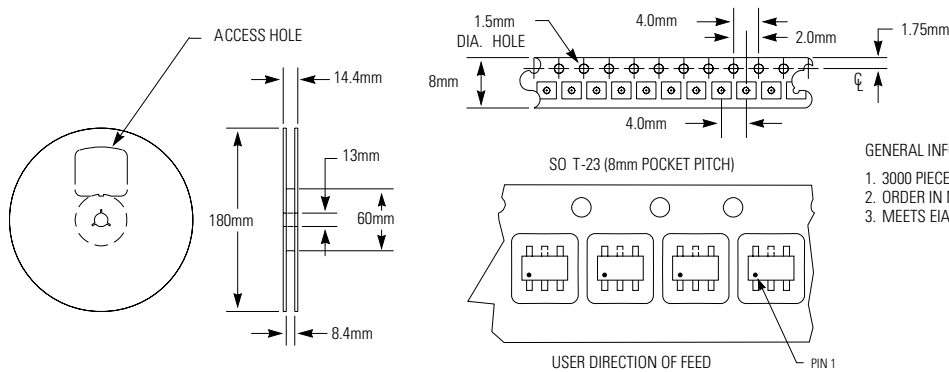

- GENERAL INFORMATION
1. 3000 PIECES PER REEL.
 2. ORDER IN MULTIPLES OF FULL REELS ONLY.
 3. MEETS EIA-481 REVISION "A" SPECIFICATIONS.

Disclaimer Notice - Information furnished is believed to be accurate and reliable. However, users should independently evaluate the suitability of and test each product selected for their own applications. Littelfuse products are not designed for, and may not be used in, all applications. Read complete Disclaimer Notice at <http://www.littelfuse.com/disclaimer-electronics>.