

Serie Medium

SR400 Nylon Cable Chain with removable frames

Inner height (D) 25 mm

Double share single link joining construction with large anti-friction single-pin. Frames removable from inner radius. Vertical separators are available. Wide frames on outer radius offer good protection. Due to its design with double-share lateral side, the chain is very robust, meanwhile offering very low friction.

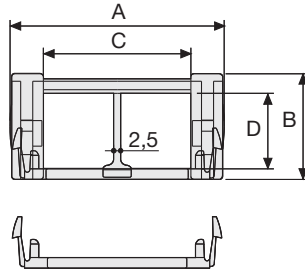

Separator

- Unassembled	Part.no S400
- Assembled	Part.no S400MC

Pin

Part.no PG305

Technical characteristics when self-supported

Speed	10 m/s
Acceleration	50 m/s ²

For higher requirements please consult our technical dept.

A	B	C	D	R	Weight/m	Chain
mm	mm	mm	mm	mm	kg	Part Number
62	35	40	25	50	1,10	SR400040
62	35	40	25	75	1,10	SR400041
62	35	40	25	100	1,10	SR400042
62	35	40	25	150	1,10	SR400043
82	35	60	25	50	1,25	SR400060
82	35	60	25	75	1,25	SR400061
82	35	60	25	100	1,25	SR400062
82	35	60	25	150	1,25	SR400063

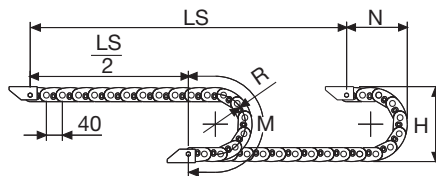

R	H	N	M
mm	mm	mm	mm
50	138	110	240
75	188	135	315
100	238	160	395
150	338	210	555

Length of chain (L)
Half travel distance ($\frac{LS}{2}$)
plus length of curve (M)

$$L = \frac{LS}{2} + M$$

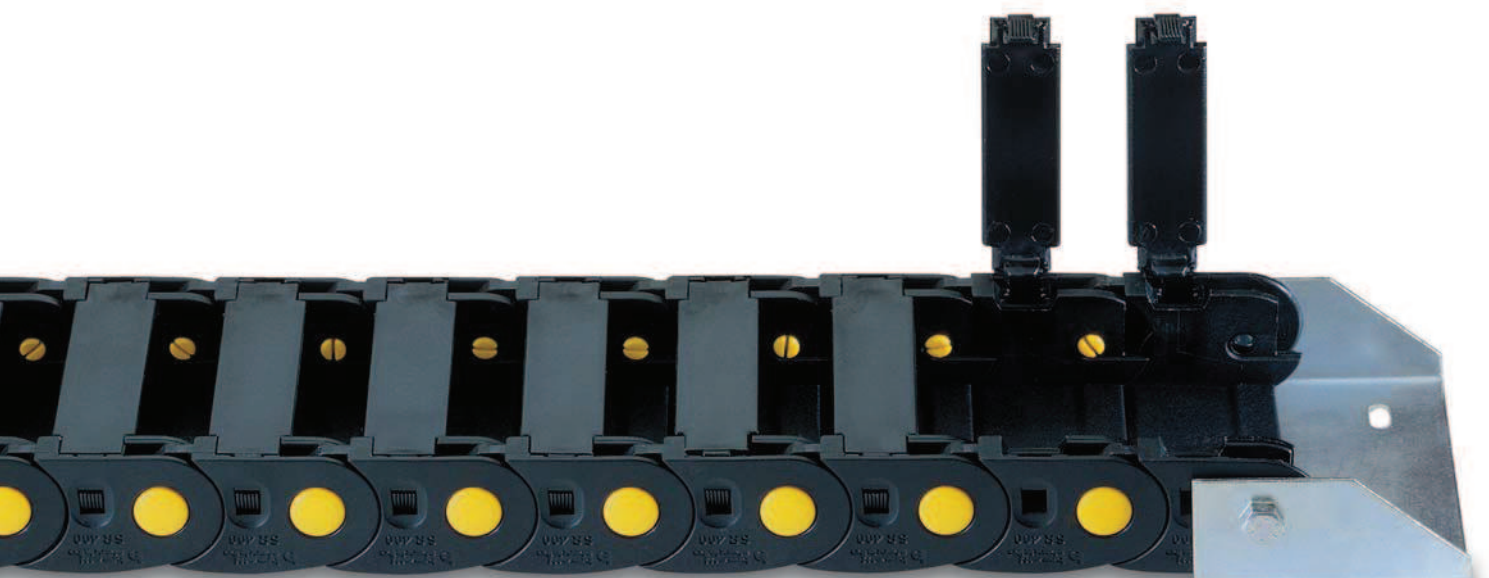

Self-Supporting Capacity Diagram

The maximum length of the self-supporting capacity ($\frac{LS}{2}$) in relationship to the weight of the cables and hoses contained per linear metre.

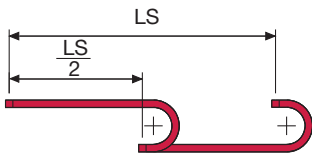
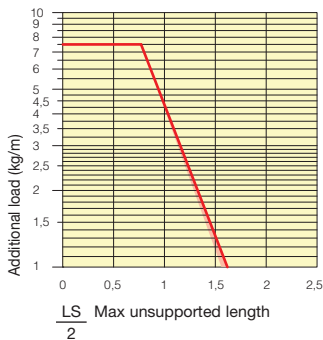

The red marking in the diagram area considers the difference of weight between various widths of chain.

For applications with $\frac{LS}{2}$ and weights not included in the area of the diagram showing self-supporting capacity, verify the possible use of support rollers (see page 30).

End Brackets

The end brackets set allows the two ends of the chain to be attached to the equipment.

Nylon Type

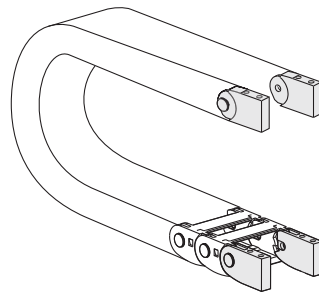

Fig. A
Chain fixed outside/inside the radius. (Fig A)

Bright Zinc Plated Steel Type***

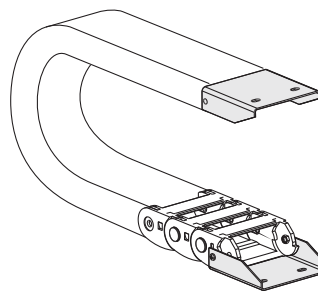
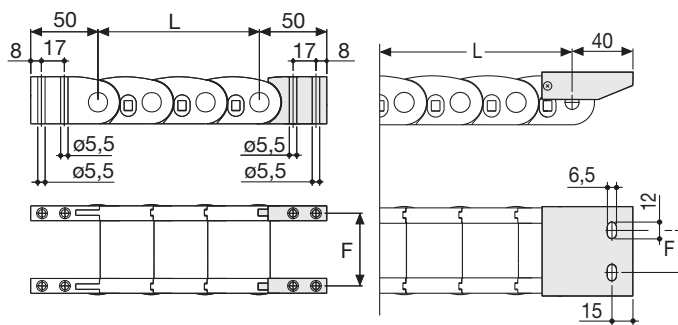

Fig. B
Chain fixed outside the radius. (Fig B)
See end brackets mounting variations page 31.



Chain Type	F mm
SR400 C=40	50
SR400 C=60	70

Chain Type	F mm
SR400 C=40	30
SR400 C=60	50

Nylon Type Part Numbers

Complete Set Assembled	
Chain Type	End Brackets Set
SR400 C=40	AN400KM
SR400 C=60	AN400KM

Complete Set Unassembled	
Chain Type	End Brackets Set
SR400 C=40	AN400K
SR400 C=60	AN400K

Bright Zinc Plated Steel Type Part Numbers

Complete Set Assembled	
Chain Type	End Brackets Set
SR400 C=40	AP400KM1
SR400 C=60	AG400KM1

Complete Set Unassembled	
Chain Type	End Brackets Set
SR400 C=40	AP400K1
SR400 C=60	AG400K1

*** Available on request in stainless steel

Serie Medium

SR400

Nylon Cable Chain with removable frames

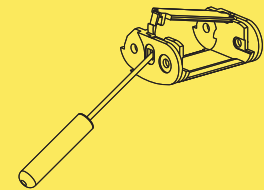
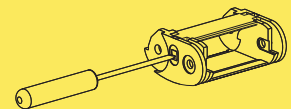

How to open the cover.

Special tool to remove the connecting pivots:
Part Number PZ010.



For further information please consult Brevetti Stendalto's Technical Office