

REVISION RECORD

REV	ECN	DESCRIPTION	DRFT	DATE
-----	-----	-------------	------	------

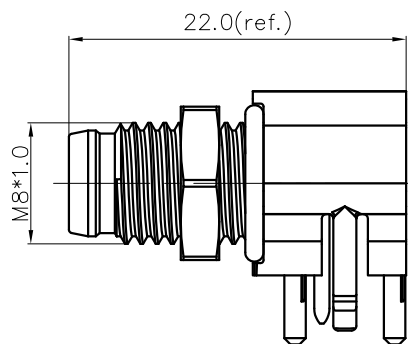
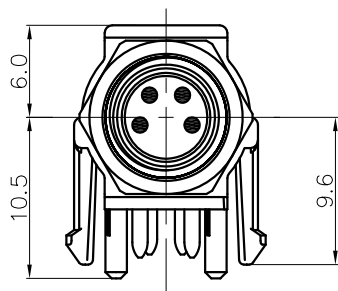

SR-M8A-XXP-MM-SF7005-00A(H)

Pin number: 03,04

NOTES:

- Rated voltage/current : 3pin: 60V / 3A
4pin: 60V / 3A
- Withstanding voltage : 850V
- Levels of protection: IP67
- Wire connection mode: soldering(PCB)
- Operating temperature: -40°C~+105°C
- For Panel Thickness Max: 1.0~2.5mm
- For PCB Thickness Max: 1.6mm
- RoHS Compliance
- Tolerance :

.X	±0.25mm
.XX	±0.1mm
∠	±1°

3pin A Coding

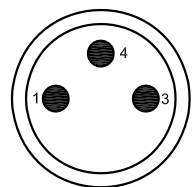

Pin Assignment Front View

4pin A Coding

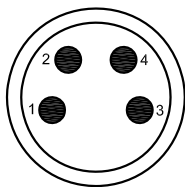

Pin Assignment Front View

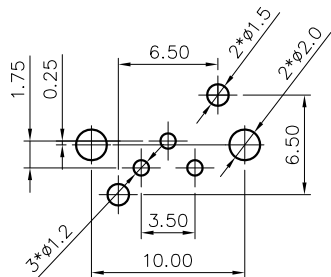

PCB layout

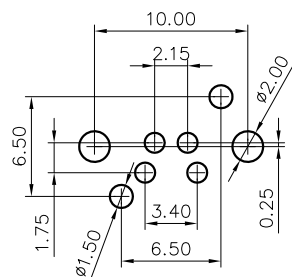

PCB layout

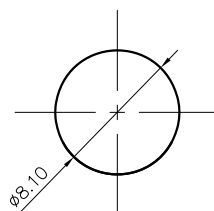

Panel cut

DETACHED LISTS	PART NO.:	宁波高松电子有限公司 NINGBO DEGSON ELECTRICAL CO., LTD			
	APPD:	NAME: SR-M8A-XXP-MM-SF7005-00A(H)			
	CHKD:				
	DRFT: SQ 2019.11.20	TITLE: CUSTOMER DRAWING	REV: D0-1		
 THIRD ANGLE PROJECTION		DRAWING NO.: XXXXXXXX-XX-CXX	SHEET: 1/1		
		 MM (INCH)	DO NOT SCALE DRAWING	SCALE: 1:1	