

SLVU2.8-4 Low Voltage TVS Diode Array



Description

The SLVU2.8-4 TVS diode is a low capacitance TVS(Transient Voltage Suppressor) device designed to protect low voltage components such as Ethernet transceivers, laser diodes, ASICs, and high-speed RAM from transients caused by electrostatic discharge(ESD), cable discharge events(CDE), lightning and other induced voltage surges.

The SLVU2.8-4 is in an SO-8 package and can be used to protect two high-speed line pair. The "flow-thru" design minimizes trace inductance and reduces voltage overshoot associated with ESD events. The low clamping voltage of the SLVU2.8-4 minimizes the stress on the protected IC.

Circuit Diagram

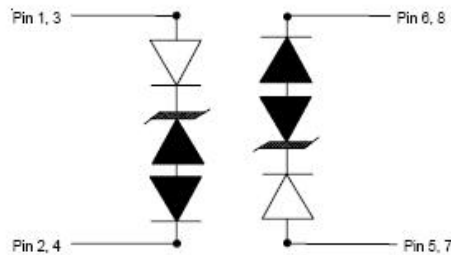

Features

- 600 Watts peak pulse power(tp=8/20us)
- Transient protection for high speed data lines
IEC 61000-4-2(ESD)±15KV(air),±8KV(contact)
IEC 61000-4-4(EFT) 40A (5/50ns)
IEC 61000-4-5(Lightning) 30A (8/20us)
- Low capacitance
- Low leakage current
- Low operating and clamping voltages
- Protects two line pairs(four lines)

Schematic and Pin Configuration

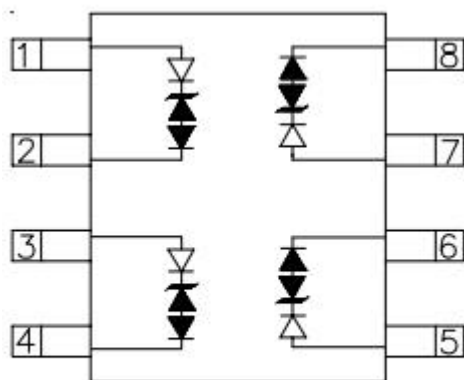

SO-8 (Top View)

Applications

- 10/100 Ethernet
- WAN/LAN Equipment
- Switching Systems
- Desktops, Servers and Notebooks
- Instrumentation
- Analog Inputs
- Base Stations

Mechanical Characteristics

- SO-8 package
- Marking: Part number, date code
- Packaging: Tape and Reel
- Molding compound flammability rating: UL 94V-0

Ordering Information:

Device	Package	Shipping
SLVU2.8-4	SO-8(Pb-Free)	2500pcs/ reel

For information on tape and reel specifications, including part orientation and tape sizes, please refer to our tape and reel packaging specification.

Maximum Ratings

Characteristics	Symbol	Max.	Units
Peak Pulse Power (tp=8/20us)	P _{PK}	600	Watts
Peak Pulse Current (tp=8/20us)	I _{PP}	30	A
ESD per IEC61000-4-2 (air)	V _{ESD}	25	KV
ESD per IEC61000-4-2 (contact)		15	
Lead Soldering Temperature	T _L	260(10 seconds)	°C
Operating Temperature	T _J	-55 to +125	°C
Storage Temperature	T _{STG}	-55 to +150	°C

Electrical Characteristics

Characteristics	Symbol	Condition	Min.	Typ.	Max.	Units
Reverse Stand-Off Voltage	V _{RWM}				2.8	V
Punch-Through Voltage	V _{PT}	I _{PT} =2uA	3.0			V
Snap-Back Voltage	V _{SB}	I _{SB} =50mA	2.8			V
Reverse Leakage Current	I _R	V _{RWM} =2.8V, T=25°C (Each Line)		0.01	1	uA
Clamping Voltage	V _C	I _{PP} =5A, tp=8/20us (Each Line)			8.5	V
Clamping Voltage	V _C	I _{PP} =10A, tp=8/20us (Each Line)			12	V
Clamping Voltage	V _C	I _{PP} =30A, tp=8/20us (Each Line)			20	V
Junction Capacitance	C _j	V _R =0V, f=1MHz (Each Line)		5		pF

Ratings and Characteristics Curves

Non-Repetitive Peak Pulse Power vs. Pulse Time

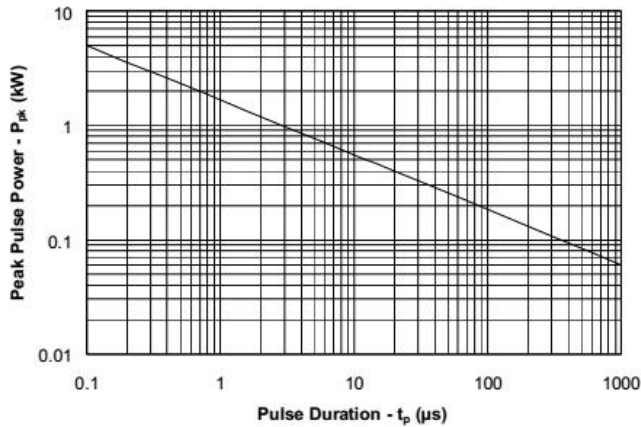

Power Derating Curve

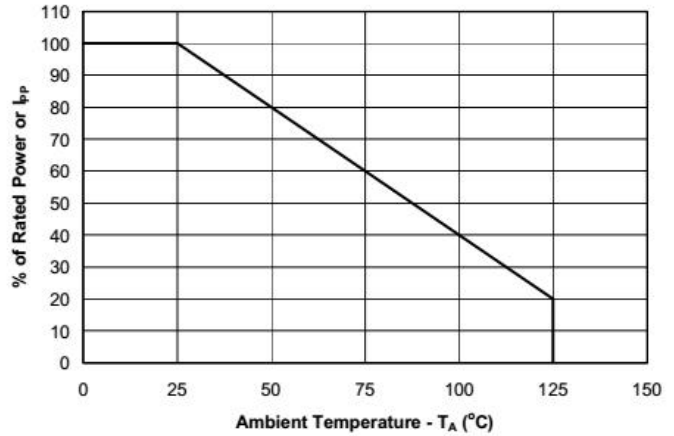

Pulse Waveform

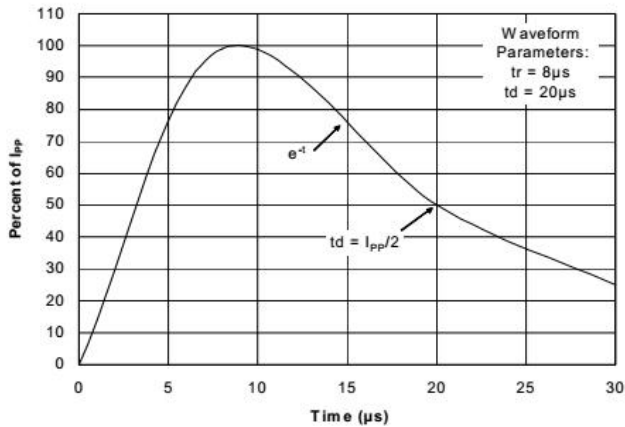

Clamping Voltage vs. Peak Pulse Current

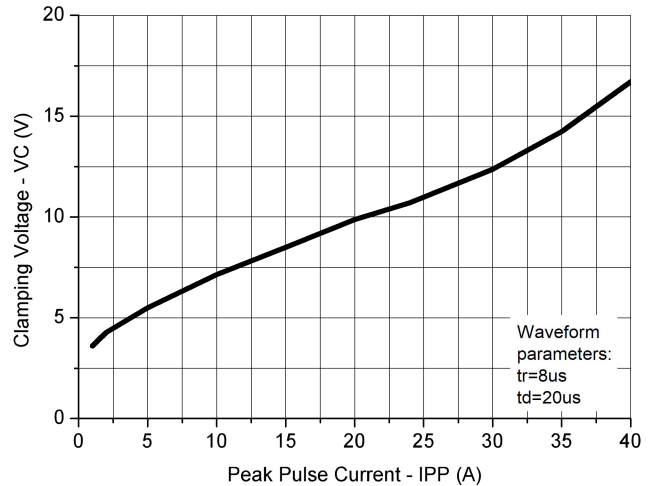

Capacitance vs. Reverse Voltage

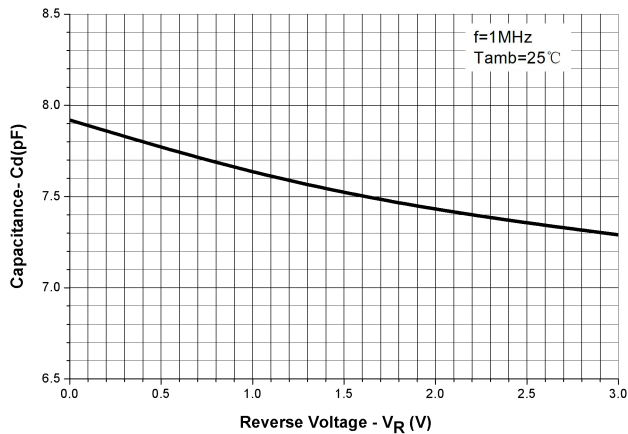

Circuit Diagram

The SLVU2.8-4 is designed to protect four data lines of sensitive components from damage and latch-up which may result from transients. Data line I/Os are connected at pin 1 and 2, 3 and 4, 5 and 6, 7 and 8.

The SLVU2.8-4 is also designed to protect two high-speed line pair. The line pairs enter at pins 1 and 2, pin 3 and 4, and exit at pin 8 and 7, pin 6 and 5.

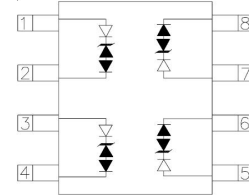

Mechanical Dimensions

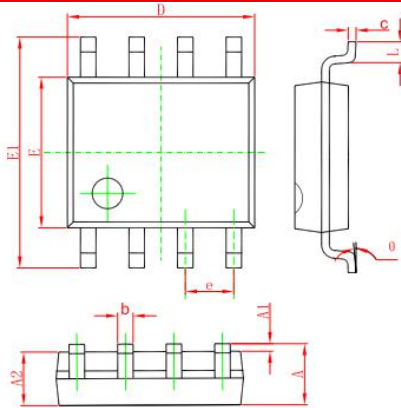

字符	Dimension In Millimeters	
	Min	Max
A	1.500	1.700
A1	0.040	0.120
A2	1.350	1.550
b	0.300	0.500
c	0.190	0.250
D	4.800	5.000
E	3.840	4.040
E1	5.900	6.100
e	1.27 (BSC)	
L	0.520	0.720
θ	0°	8°

Carrier Tape Specification

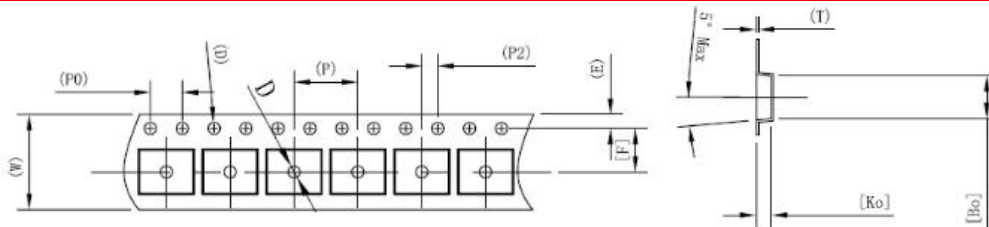

ITEM	W	A0	A1	B0	B1	K0	K1	E	F	P	P0	P2	D0	D1	T
DIM	12.0	6.55	0.00	5.40	0.00	1.90	0.00	1.75	5.50	8.0	4.0	2.0	1.50	1.50	0.25
TOLE	+0.30 -0.30	±0.10	±0.10	±0.10	±0.10	±0.10	±0.10	±0.10	±0.10	±0.10	±0.10	±0.10	+0.10 -0.00	+0.10 -0.00	±0.05

unit: mm

Marking Diagram

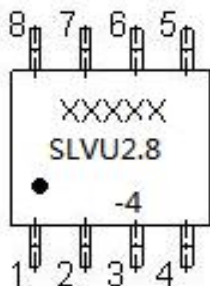

Where XXXXX is YYWWL

- SLVU2.8-4 = Part Number
- YY = Year
- WW = Week
- L = Lot Number

DISCLAIMER:

- 1- The information given herein, including the specifications and dimensions, is subject to change without prior notice to improve product characteristics. Before ordering, purchasers are advised to contact the SMC Diode Solutions sales department for the latest version of the datasheet(s).
- 2- In cases where extremely high reliability is required (such as use in nuclear power control, aerospace and aviation, traffic equipment, medical equipment, and safety equipment), safety should be ensured by using semiconductor devices that feature assured safety or by means of users' fail-safe precautions or other arrangement.
- 3- In no event shall SMC Diode Solutions be liable for any damages that may result from an accident or any other cause during operation of the user's units according to the datasheet(s). SMC Diode Solution assumes no responsibility for any intellectual property claims or any other problems that may result from applications of information, products or circuits described in the datasheets.
- 4- In no event shall SMC Diode Solutions be liable for any failure in a semiconductor device or any secondary damage resulting from use at a value exceeding the absolute maximum rating.
- 5- No license is granted by the datasheet(s) under any patents or other rights of any third party or SMC Diode Solutions.
- 6- The datasheet(s) may not be reproduced or duplicated, in any form, in whole or part, without the expressed written permission of SMC Diode Solutions.
- 7- The products (technologies) described in the datasheet(s) are not to be provided to any party whose purpose in their application will hinder maintenance of international peace and safety nor are they to be applied to that purpose by their direct purchasers or any third party. When exporting these products (technologies), the necessary procedures are to be taken in accordance with related laws and regulations.