

# SEMiX453GB12M7p



SEMiX® 3p

## Trench IGBT Modules

### SEMiX453GB12M7p

#### Features\*

- Homogeneous Si
- Trench = Trenchgate technology
- $V_{CE(sat)}$  with positive temperature coefficient
- High overload capability
- Low loss high density IGBTs
- Press-fit pins as auxiliary contacts
- UL recognized, file no. E63532

#### Typical Applications

- AC inverter drives
- UPS
- Renewable energy systems

#### Remarks

- Product reliability results are valid for  $T_j=150^\circ\text{C}$  (recommended  $T_{j,op}=-40\dots+150^\circ\text{C}$ )
- $V_{isol}$  between temperature sensor and power section is only 2500V
- For storage and case temperature with TIM see document "TP(\*) SEMiX 3p"

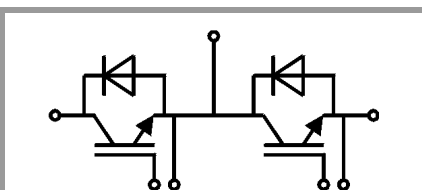

GB

Absolute Maximum Ratings				
Symbol	Conditions	Values	Unit	
<b>IGBT</b>				
$V_{CES}$	$T_j = 25^\circ\text{C}$	1200	V	
$I_C$	$T_j = 175^\circ\text{C}$	$T_c = 25^\circ\text{C}$	601	A
		$T_c = 80^\circ\text{C}$	457	A
$I_{Cnom}$		450	A	
$I_{CRM}$		900	A	
$V_{GES}$		-20 ... 20	V	
$t_{psc}$	$V_{CC} = 800\text{ V}$ $V_{GE} \leq 15\text{ V}$ $V_{CES} \leq 1200\text{ V}$	$T_j = 150^\circ\text{C}$	8	$\mu\text{s}$
$T_j$		-40 ... 175	$^\circ\text{C}$	
<b>Inverse diode</b>				
$V_{RRM}$	$T_j = 25^\circ\text{C}$	1200	V	
$I_F$	$T_j = 175^\circ\text{C}$	$T_c = 25^\circ\text{C}$	554	A
		$T_c = 80^\circ\text{C}$	415	A
$I_{FRM}$		900	A	
$I_{FSM}$	$t_p = 10\text{ ms, sin } 180^\circ, T_j = 25^\circ\text{C}$	2430	A	
$T_j$		-40 ... 175	$^\circ\text{C}$	
<b>Module</b>				
$I_{t(RMS)}$		600	A	
$T_{stg}$	module without TIM	-40 ... 125	$^\circ\text{C}$	
$V_{isol}$	AC sinus 50Hz, $t = 1\text{ min}$	4000	V	

Characteristics					
Symbol	Conditions	min.	typ.	max.	Unit
<b>IGBT</b>					
$V_{CE(sat)}$	$I_C = 450\text{ A}$ $V_{GE} = 15\text{ V}$ chipelevel	$T_j = 25^\circ\text{C}$	1.55	1.88	V
		$T_j = 150^\circ\text{C}$	1.80		V
$V_{CE0}$	chipelevel	$T_j = 25^\circ\text{C}$	0.87	0.95	V
		$T_j = 150^\circ\text{C}$	0.76		V
$r_{CE}$	$V_{GE} = 15\text{ V}$ chipelevel	$T_j = 25^\circ\text{C}$	1.51	2.1	$\text{m}\Omega$
		$T_j = 150^\circ\text{C}$	2.3		$\text{m}\Omega$
$V_{GE(th)}$	$V_{CE} = 10\text{ V}, I_C = 45\text{ mA}$	5.4	6	6.6	V
$I_{CES}$	$V_{GE} = 0\text{ V}, V_{CE} = 1200\text{ V}, T_j = 25^\circ\text{C}$			4.5	$\text{mA}$
$C_{ies}$	$V_{CE} = 10\text{ V}$ $V_{GE} = 0\text{ V}$	$f = 1\text{ MHz}$	90.0		nF
$C_{oes}$		$f = 1\text{ MHz}$	2.74		nF
$C_{res}$		$f = 1\text{ MHz}$	0.96		nF
$Q_G$	$V_{GE} = -8\text{ V} \dots +15\text{ V}$		4020		nC
$R_{Gint}$	$T_j = 25^\circ\text{C}$		1.0		$\Omega$
$t_{d(on)}$	$V_{CC} = 600\text{ V}$ $I_C = 450\text{ A}$	$T_j = 150^\circ\text{C}$	280		ns
$t_r$	$V_{GE} = +15/-15\text{ V}$	$T_j = 150^\circ\text{C}$	75		ns
$E_{on}$	$R_{G on} = 1.1\ \Omega$	$T_j = 150^\circ\text{C}$	39		mJ
$t_{d(off)}$	$R_{G off} = 1.1\ \Omega$	$T_j = 150^\circ\text{C}$	410		ns
$t_f$	$di/dt_{on} = 6300\text{ A}/\mu\text{s}$ $di/dt_{off} = 3800\text{ A}/\mu\text{s}$	$T_j = 150^\circ\text{C}$	100		ns
$E_{off}$	$dv/dt = 5250\text{ V}/\mu\text{s}$ $L_s = 25\text{ nH}$	$T_j = 150^\circ\text{C}$	49		mJ
$R_{th(j-c)}$	per IGBT			0.083	K/W
$R_{th(c-s)}$	per IGBT ( $\lambda_{grease}=0.81\text{ W}/(\text{m}^2\text{K})$ )		0.03		K/W
$R_{th(c-s)}$	per IGBT, pre-applied phase change material		0.021		K/W



SEMiX® 3p

## Trench IGBT Modules

### SEMiX453GB12M7p

#### Features\*

- Homogeneous Si
- Trench = Trenchgate technology
- $V_{CE(sat)}$  with positive temperature coefficient
- High overload capability
- Low loss high density IGBTs
- Press-fit pins as auxiliary contacts
- UL recognized, file no. E63532

#### Typical Applications

- AC inverter drives
- UPS
- Renewable energy systems

#### Remarks

- Product reliability results are valid for  $T_j=150^\circ\text{C}$  (recommended  $T_{j,op}=-40\dots+150^\circ\text{C}$ )
- $V_{isol}$  between temperature sensor and power section is only 2500V
- For storage and case temperature with TIM see document "TP(\*) SEMiX 3p"

Characteristics						
Symbol	Conditions		min.	typ.	max.	Unit
<b>Inverse diode</b>						
$V_F = V_{EC}$	$I_F = 450\text{ A}$ $V_{GE} = 0\text{ V}$ chipelevel	$T_j = 25^\circ\text{C}$		2.14	2.46	V
		$T_j = 150^\circ\text{C}$		2.07	2.38	V
$V_{F0}$	chipelevel	$T_j = 25^\circ\text{C}$		1.30	1.50	V
		$T_j = 150^\circ\text{C}$		0.90	1.10	V
$r_F$	chipelevel	$T_j = 25^\circ\text{C}$		1.87	2.1	m $\Omega$
		$T_j = 150^\circ\text{C}$		2.6	2.8	m $\Omega$
$I_{RRM}$	$I_F = 450\text{ A}$	$T_j = 150^\circ\text{C}$		430		A
$Q_{rr}$	$di/dt_{off} = 6400\text{ A}/\mu\text{s}$	$T_j = 150^\circ\text{C}$		76		$\mu\text{C}$
$E_{rr}$	$V_{GE} = -15\text{ V}$ $V_{CC} = 600\text{ V}$	$T_j = 150^\circ\text{C}$		35		mJ
$R_{th(j-c)}$	per diode				0.107	K/W
$R_{th(c-s)}$	per diode ( $\lambda_{grease}=0.81\text{ W}/(\text{m}^2\text{K})$ )			0.045		K/W
$R_{th(c-s)}$	per diode, pre-applied phase change material			0.036		K/W
<b>Module</b>						
$L_{CE}$				20		nH
$R_{CC+EE}$	measured per switch	$T_C = 25^\circ\text{C}$		0.95		m $\Omega$
		$T_C = 125^\circ\text{C}$		1.25		m $\Omega$
$R_{th(c-s)1}$	calculated without thermal coupling			0.009		K/W
$R_{th(c-s)2}$	including thermal coupling, $T_s$ underneath module ( $\lambda_{grease}=0.81\text{ W}/(\text{m}^2\text{K})$ )			0.014		K/W
$R_{th(c-s)2}$	including thermal coupling, $T_s$ underneath module, pre-applied phase change material			0.010		K/W
$M_s$	to heat sink (M5)		3		6	Nm
$M_t$		to terminals (M6)	3		6	Nm
						Nm
$w$					350	g
<b>Temperature Sensor</b>						
$R_{100}$	$T_c=100^\circ\text{C}$ ( $R_{25}=5\text{ k}\Omega$ )			$493 \pm 5\%$		$\Omega$
$B_{100/125}$	$R_{(T)}=R_{100}\exp[B_{100/125}(1/T-1/T_{100})]$ ; $T[\text{K}]$ ;			$3550 \pm 2\%$		K



GB

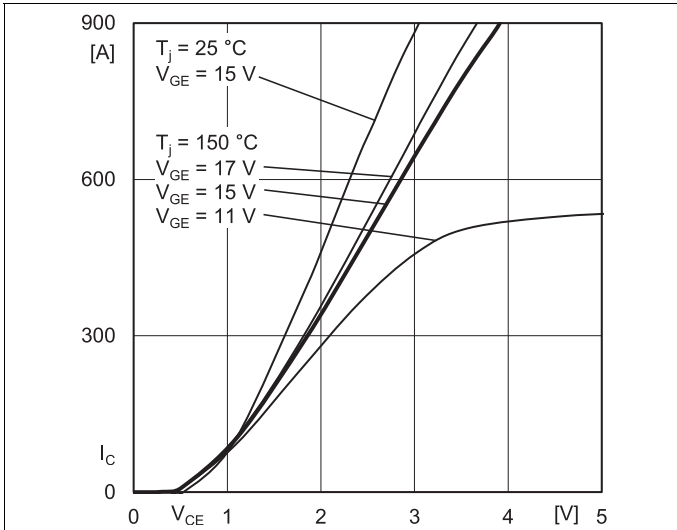

Fig. 1: Typ. output characteristic, inclusive  $R_{CC'+EE'}$

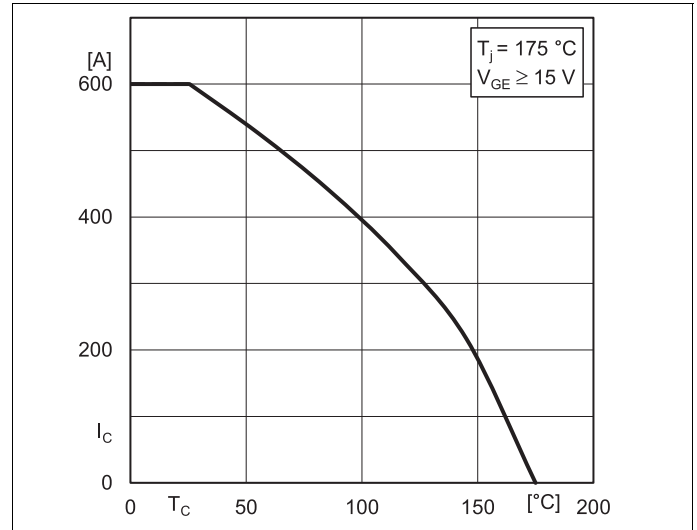

Fig. 2: Rated current vs. temperature  $I_C = f(T_C)$

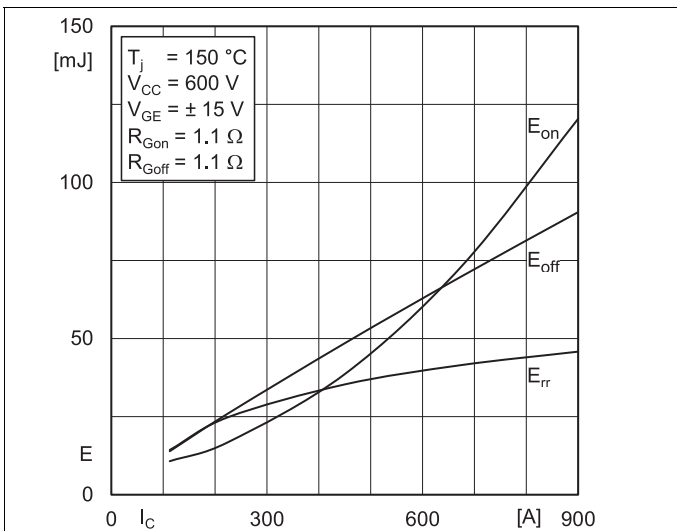

Fig. 3: Typ. turn-on /-off energy =  $f(I_C)$

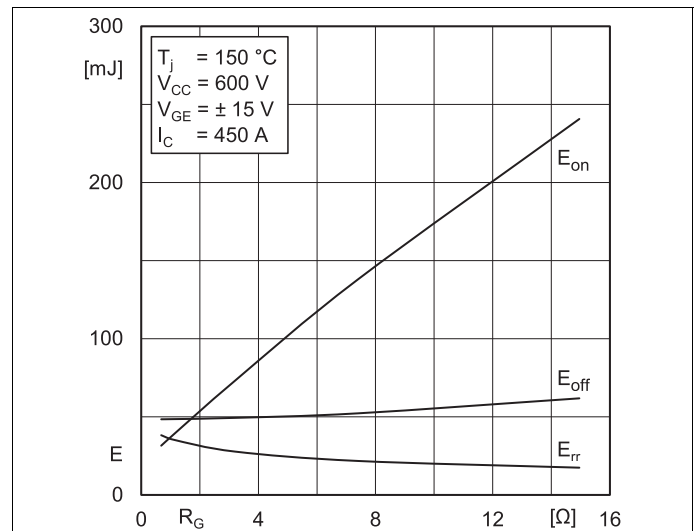

Fig. 4: Typ. turn-on /-off energy =  $f(R_G)$

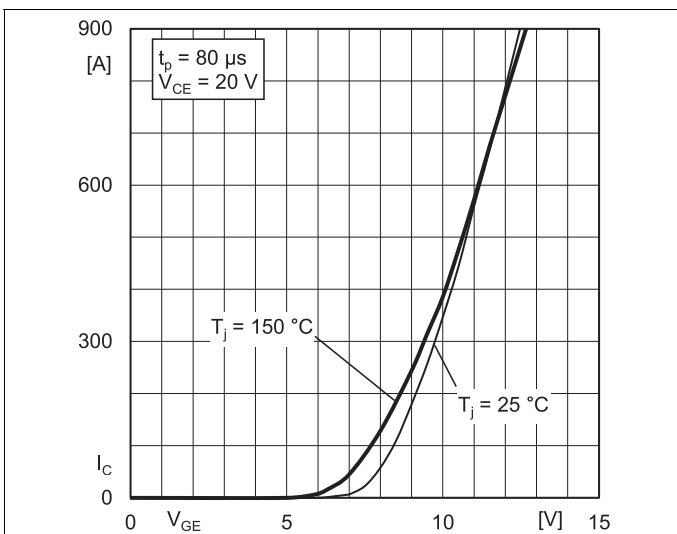

Fig. 5: Typ. transfer characteristic

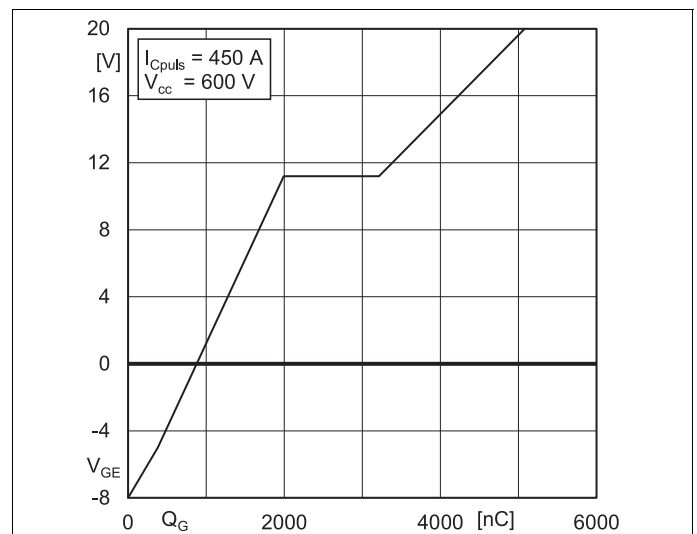
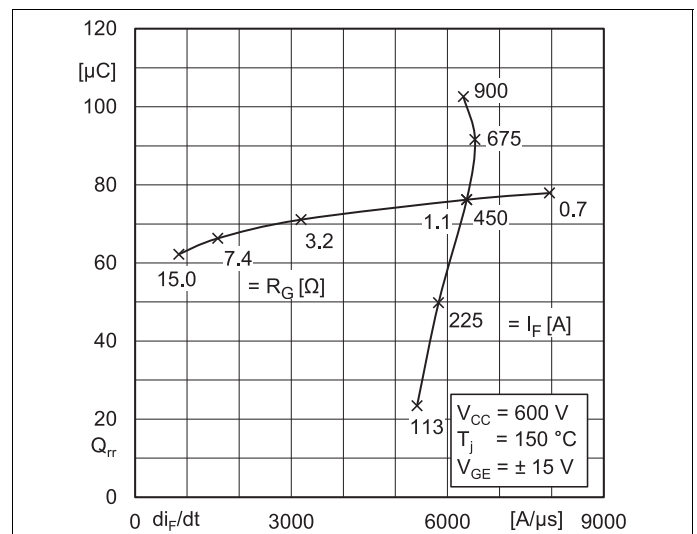
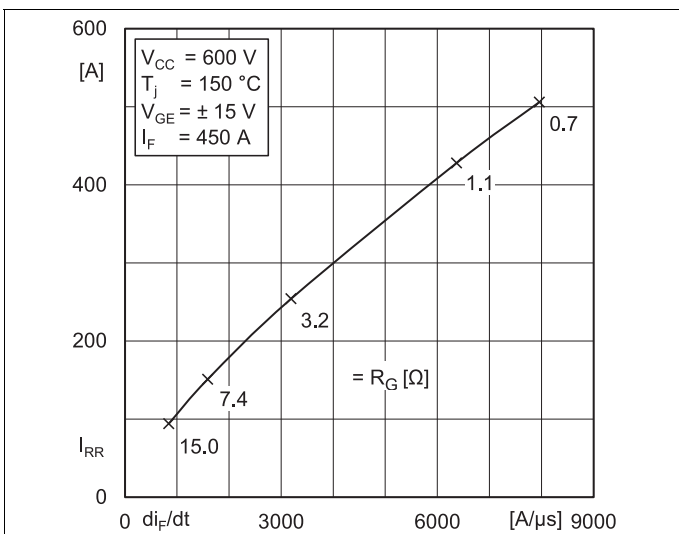
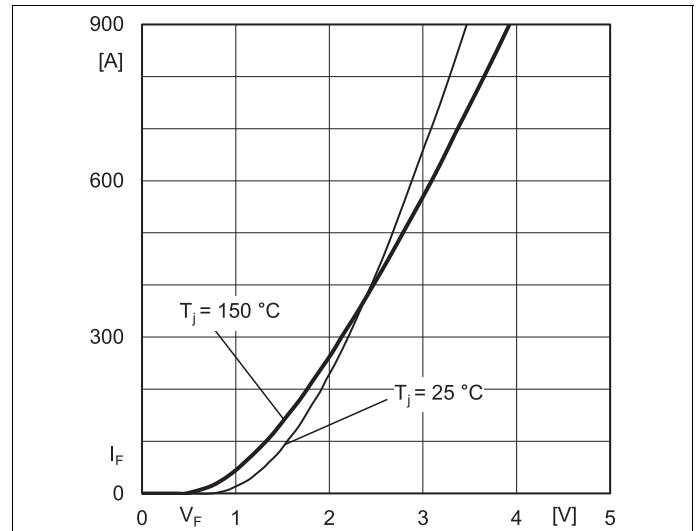
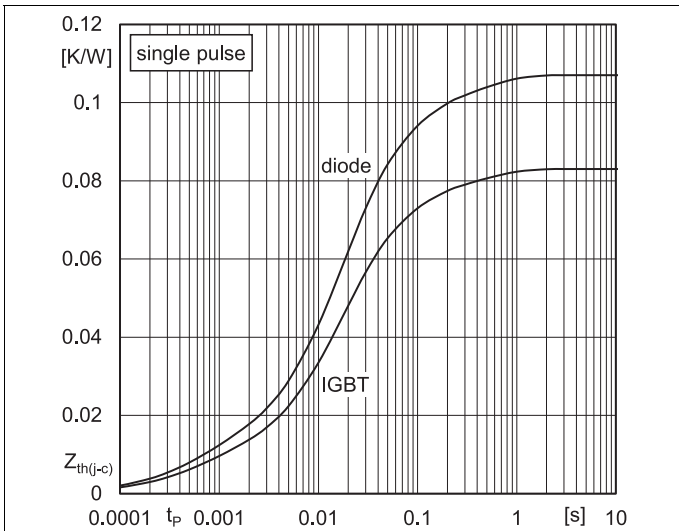
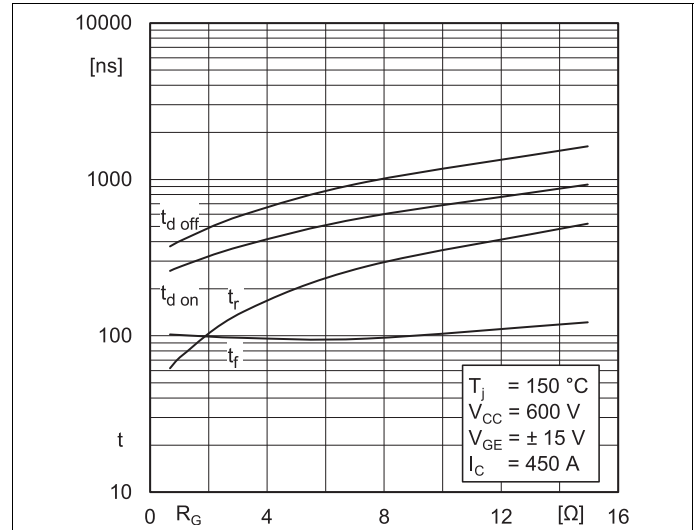
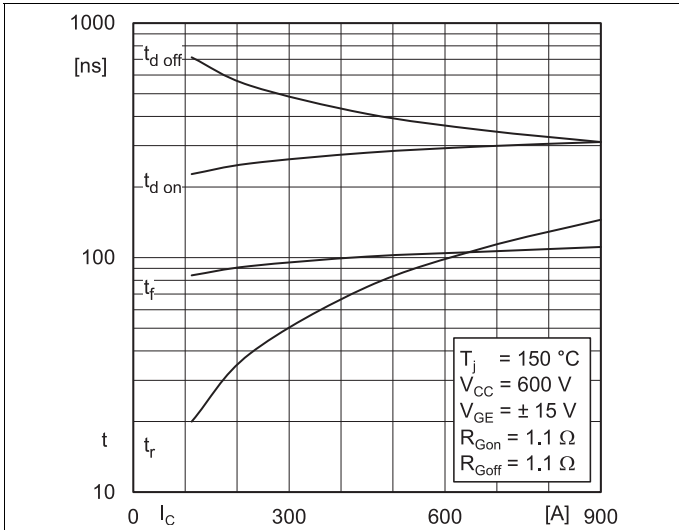

Fig. 6: Typ. gate charge characteristic



# SEMiX453GB12M7p

Package outline

	0,3 connector 3-4/10-11
	0,2 each single connector A

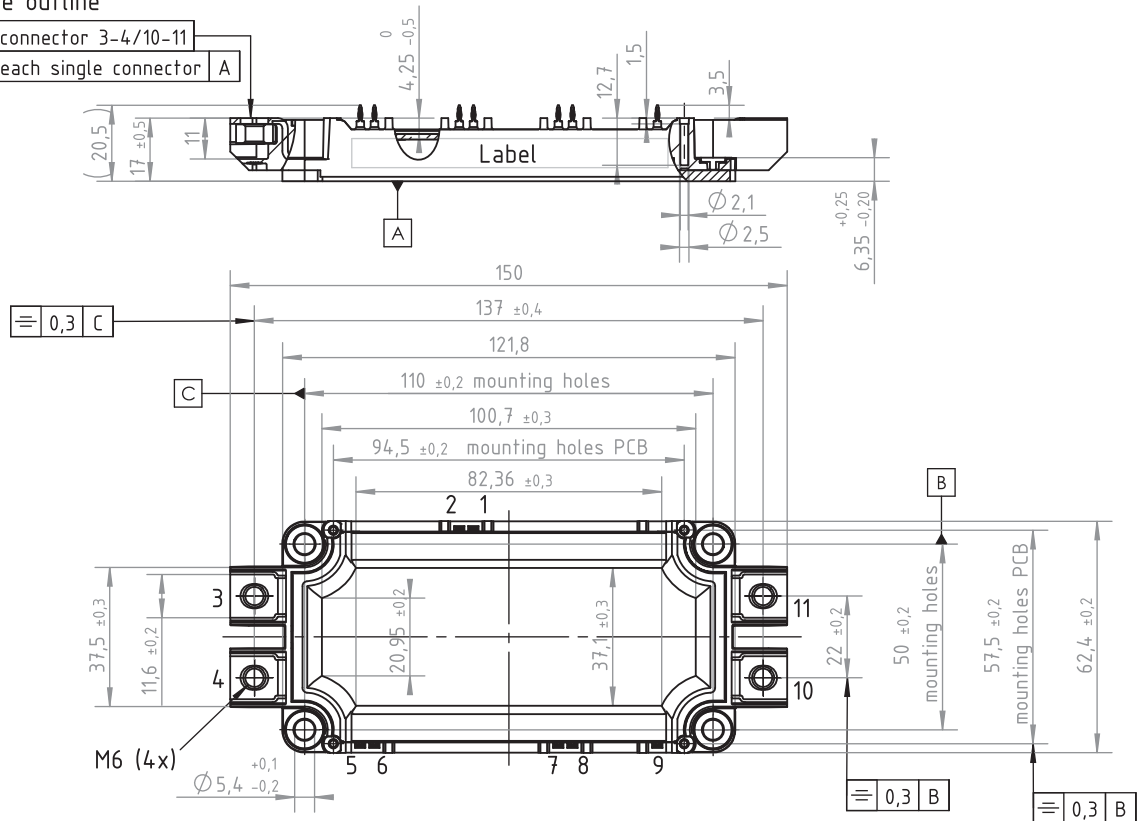

PCB drillhole pattern

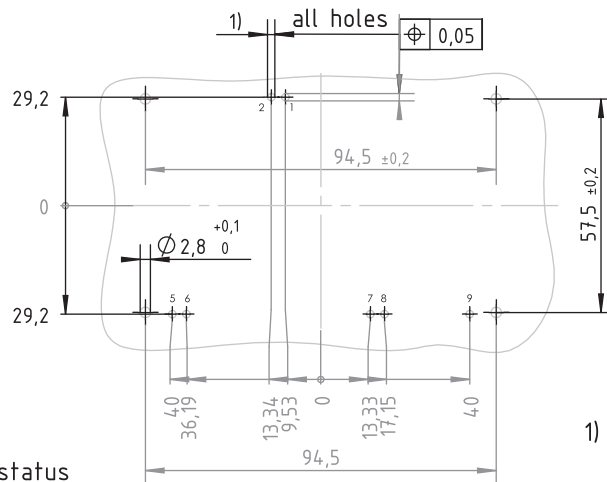

Dimensions in mm

Dimensions valid in mounted status

1) PCB hole specification see Mounting Instructions SEMiX press-fit

SEMiX 3p

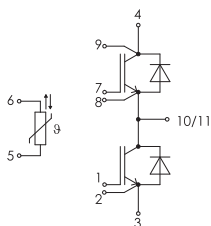

pinout

This is an electrostatic discharge sensitive device (ESDS) due to international standard IEC 61340.

## **\*IMPORTANT INFORMATION AND WARNINGS**

The specifications of SEMIKRON products may not be considered as guarantee or assurance of product characteristics ("Beschaffenheitsgarantie"). The specifications of SEMIKRON products describe only the usual characteristics of products to be expected in typical applications, which may still vary depending on the specific application. Therefore, products must be tested for the respective application in advance. Application adjustments may be necessary. The user of SEMIKRON products is responsible for the safety of their applications embedding SEMIKRON products and must take adequate safety measures to prevent the applications from causing a physical injury, fire or other problem if any of SEMIKRON products become faulty. The user is responsible to make sure that the application design is compliant with all applicable laws, regulations, norms and standards. Except as otherwise explicitly approved by SEMIKRON in a written document signed by authorized representatives of SEMIKRON, SEMIKRON products may not be used in any applications where a failure of the product or any consequences of the use thereof can reasonably be expected to result in personal injury. No representation or warranty is given and no liability is assumed with respect to the accuracy, completeness and/or use of any information herein, including without limitation, warranties of non-infringement of intellectual property rights of any third party. SEMIKRON does not assume any liability arising out of the applications or use of any product; neither does it convey any license under its patent rights, copyrights, trade secrets or other intellectual property rights, nor the rights of others. SEMIKRON makes no representation or warranty of non-infringement or alleged non-infringement of intellectual property rights of any third party which may arise from applications. Due to technical requirements our products may contain dangerous substances. For information on the types in question please contact the nearest SEMIKRON sales office. This document supersedes and replaces all information previously supplied and may be superseded by updates. SEMIKRON reserves the right to make changes.