

# BCP53 Series

## PNP Silicon Epitaxial Transistors

This PNP Silicon Epitaxial transistor is designed for use in audio amplifier applications. The device is housed in the SOT-223 package which is designed for medium power surface mount applications.

- High Current
- NPN Complement is BCP56
- The SOT-223 Package can be soldered using wave or reflow.  
The formed leads absorb thermal stress during soldering, eliminating the possibility of damage to the die
- Device Marking:  
BCP53T1G = AH  
BCP53-10T1G = AH-10  
BCP53-16T1G = AH-16
- S and NSV Prefix for Automotive and Other Applications Requiring Unique Site and Control Change Requirements; AEC-Q101 Qualified and PPAP Capable
- These Devices are Pb-Free, Halogen Free/BFR Free and are RoHS Compliant

### MAXIMUM RATINGS (T<sub>C</sub> = 25°C unless otherwise noted)

Rating	Symbol	Value	Unit
Collector-Emitter Voltage	V <sub>CEO</sub>	-80	Vdc
Collector-Base Voltage	V <sub>CBO</sub>	-100	Vdc
Emitter-Base Voltage	V <sub>EBO</sub>	-5.0	Vdc
Collector Current	I <sub>C</sub>	1.5	Adc
Total Power Dissipation @ T <sub>A</sub> = 25°C (Note 1) Derate above 25°C	P <sub>D</sub>	1.5 12	W mW/°C
Operating and Storage Temperature Range	T <sub>J</sub> , T <sub>stg</sub>	-65 to +150	°C

Stresses exceeding those listed in the Maximum Ratings table may damage the device. If any of these limits are exceeded, device functionality should not be assumed, damage may occur and reliability may be affected.

1. Device mounted on a glass epoxy printed circuit board 1.575 in. x 1.575 in. x 0.059 in.; mounting pad for the collector lead min. 0.93 sq. in.

### THERMAL CHARACTERISTICS

Characteristic	Symbol	Max	Unit
Thermal Resistance, Junction-to-Ambient (Surface Mounted)	R <sub>θJA</sub>	83.3	°C/W
Lead Temperature for Soldering, 0.0625" from case Time in Solder Bath	T <sub>L</sub>	260 10	°C s



**ON Semiconductor®**

[www.onsemi.com](http://www.onsemi.com)

## MEDIUM POWER HIGH CURRENT SURFACE MOUNT PNP TRANSISTORS

COLLECTOR 2, 4

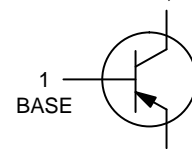

EMITTER 3

### MARKING DIAGRAM

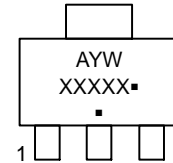

- A = Assembly Location
- Y = Year
- W = Work Week
- XXXXX = Specific Device Code
- = Pb-Free Package

(Note: Microdot may be in either location)

### ORDERING INFORMATION

Device	Package	Shipping†
BCP53T1G	SOT-223 (Pb-Free)	1000/Tape & Reel
SBCP53-10T1G	SOT-223 (Pb-Free)	1000/Tape & Reel
BCP53-10T1G	SOT-223 (Pb-Free)	1000/Tape & Reel
SBCP53-10T1G	SOT-223 (Pb-Free)	1000/Tape & Reel
BCP53-16T1G	SOT-223 (Pb-Free)	1000/Tape & Reel
SBCP53-16T1G	SOT-223 (Pb-Free)	1000/Tape & Reel
BCP53-16T3G	SOT-223 (Pb-Free)	4000/Tape & Reel
NSVBCP53-16T3G	SOT-223 (Pb-Free)	4000/Tape & Reel

†For information on tape and reel specifications, including part orientation and tape sizes, please refer to our Tape and Reel Packaging Specifications Brochure, BRD8011/D.

## BCP53 Series

### ELECTRICAL CHARACTERISTICS ( $T_A = 25^\circ\text{C}$ unless otherwise noted)

Characteristics	Symbol	Min	Typ	Max	Unit
-----------------	--------	-----	-----	-----	------

#### OFF CHARACTERISTICS

Collector–Base Breakdown Voltage ( $I_C = -100\ \mu\text{Adc}$ , $I_E = 0$ )	$V_{(BR)CBO}$	-100	-	-	Vdc
Collector–Emitter Breakdown Voltage ( $I_C = -1.0\ \text{mAdc}$ , $I_B = 0$ )	$V_{(BR)CEO}$	-80	-	-	Vdc
Collector–Emitter Breakdown Voltage ( $I_C = -100\ \mu\text{Adc}$ , $R_{BE} = 1.0\ \text{k}\Omega$ )	$V_{(BR)CER}$	-100	-	-	Vdc
Emitter–Base Breakdown Voltage ( $I_E = -10\ \mu\text{Adc}$ , $I_C = 0$ )	$V_{(BR)EBO}$	-5.0	-	-	Vdc
Collector–Base Cutoff Current ( $V_{CB} = -30\ \text{Vdc}$ , $I_E = 0$ )	$I_{CBO}$	-	-	-100	nAdc
Emitter–Base Cutoff Current ( $V_{EB} = -5.0\ \text{Vdc}$ , $I_C = 0$ )	$I_{EBO}$	-	-	-100	nAdc

#### ON CHARACTERISTICS

DC Current Gain ( $I_C = -5.0\ \text{mAdc}$ , $V_{CE} = -2.0\ \text{Vdc}$ ) All Part Types	$h_{FE}$	25	-	-	-
( $I_C = -150\ \text{mAdc}$ , $V_{CE} = -2.0\ \text{Vdc}$ ) BCP53, SBCP53		40	-	250	
BCP53–10, SBCP53–10		63	-	160	
BCP53–16, SBCP53–16, NSVBCP53–16		100	-	250	
( $I_C = -500\ \text{mAdc}$ , $V_{CE} = -2.0\ \text{Vdc}$ ) All Part Types		25	-	-	
Collector–Emitter Saturation Voltage ( $I_C = -500\ \text{mAdc}$ , $I_B = -50\ \text{mAdc}$ )	$V_{CE(sat)}$	-	-	-0.5	Vdc
Base–Emitter On Voltage ( $I_C = -500\ \text{mAdc}$ , $V_{CE} = -2.0\ \text{Vdc}$ )	$V_{BE(on)}$	-	-	-1.0	Vdc

#### DYNAMIC CHARACTERISTICS

Current–Gain – Bandwidth Product ( $I_C = -10\ \text{mAdc}$ , $V_{CE} = -5.0\ \text{Vdc}$ , $f = 35\ \text{MHz}$ )	$f_T$	-	50	-	MHz
---	-------	---	----	---	-----

Product parametric performance is indicated in the Electrical Characteristics for the listed test conditions, unless otherwise noted. Product performance may not be indicated by the Electrical Characteristics if operated under different conditions.

# BCP53 Series

## TYPICAL CHARACTERISTICS

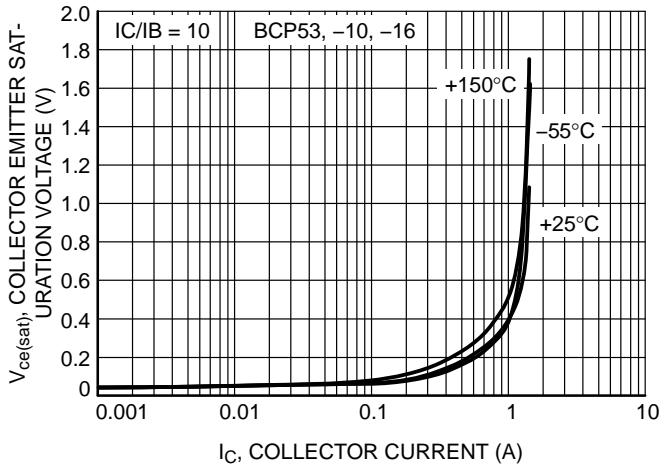

**Figure 1. Collector Emitter Saturation Voltage vs. Collector Current**

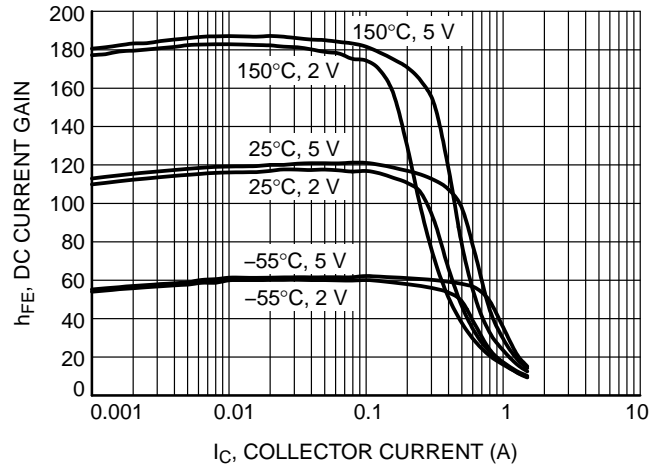

**Figure 2. DC Current Gain vs. Collector Current (BCP53)**

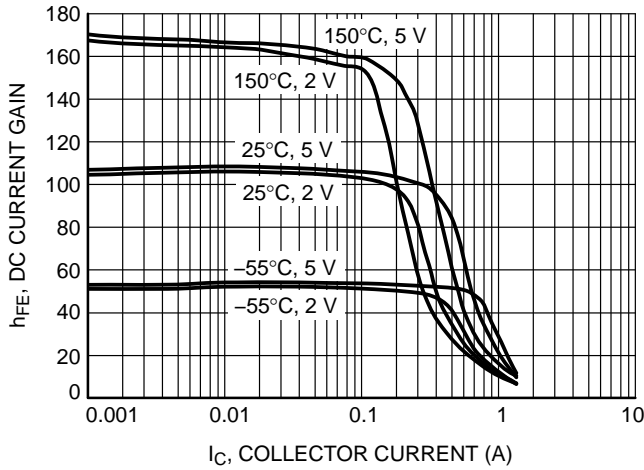

**Figure 3. DC Current Gain vs. Collector Current (BCP53-10)**

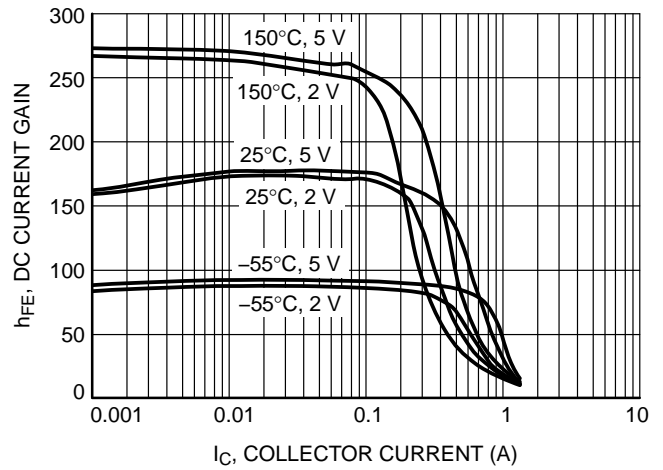

**Figure 4. DC Current Gain vs. Collector Current (BCP53-16)**

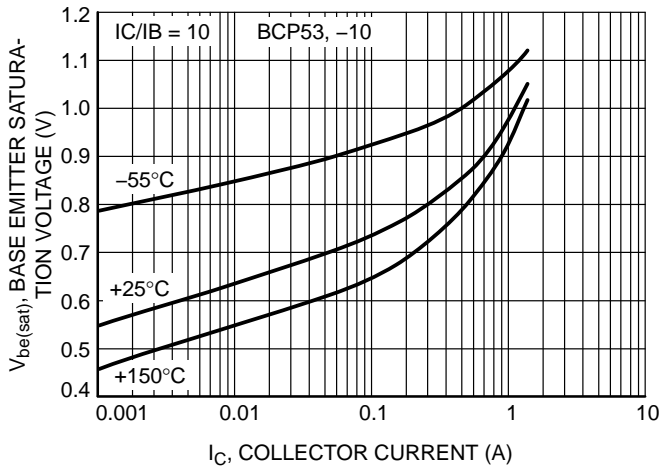

**Figure 5. BCP53, -10 Base Emitter Saturation Voltage vs. Collector Current**

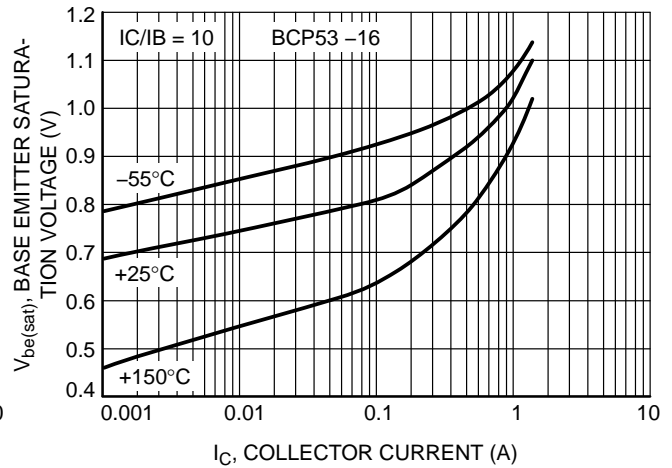

**Figure 6. BCP53-16 Base Emitter Saturation Voltage vs. Collector Current**

# BCP53 Series

## TYPICAL CHARACTERISTICS

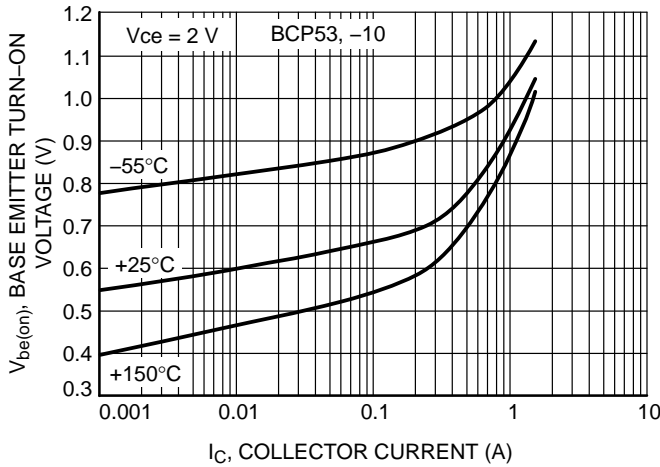

**Figure 7. BCP53, -10 Base Emitter Turn-On Voltage vs. Collector Current  $V_{BE(on)}$**

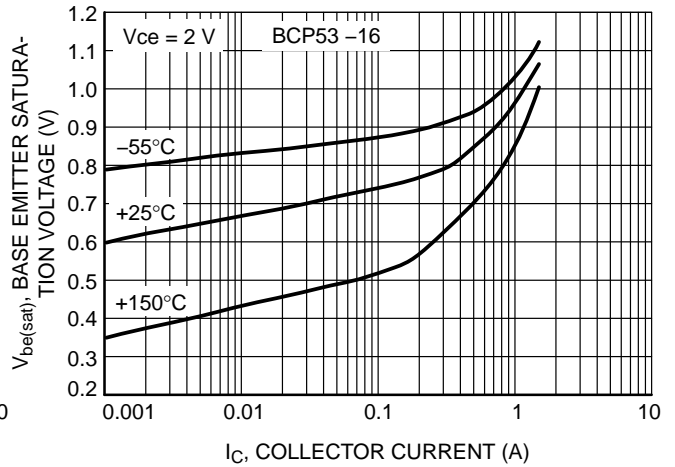

**Figure 8. BCP53-16 Base Emitter Turn-On Voltage vs. Collector Current**

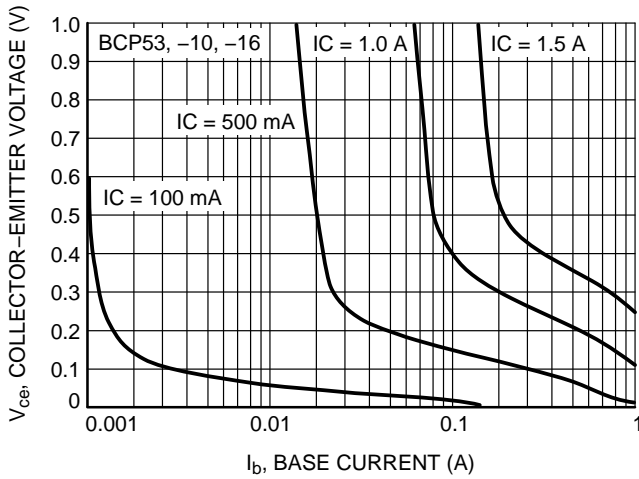

**Figure 9. BCP53, -10, -16 Saturation Region**

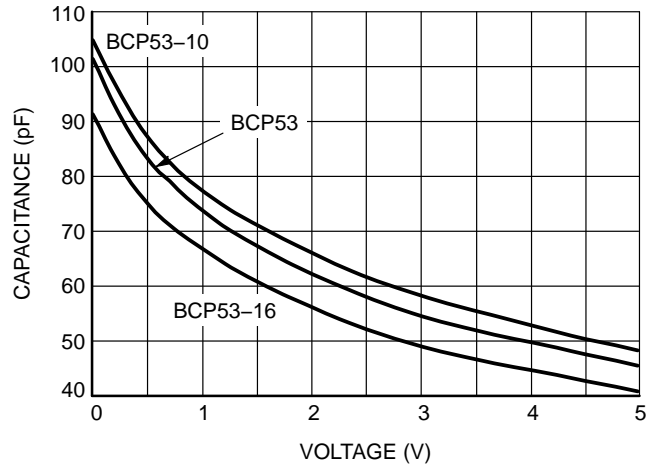

**Figure 10. Input Capacitance**

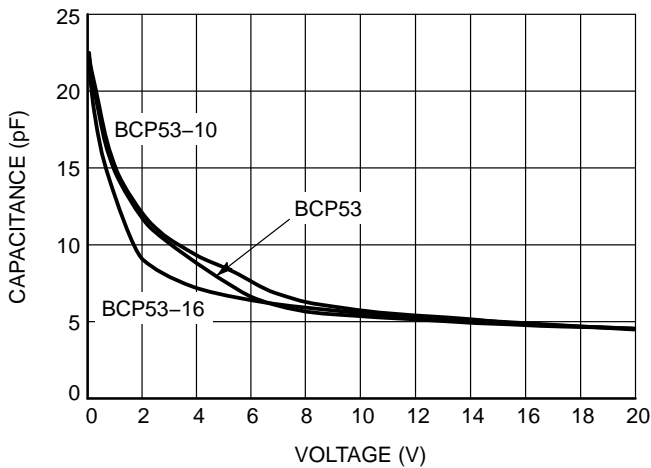

**Figure 11. Output Capacitance**

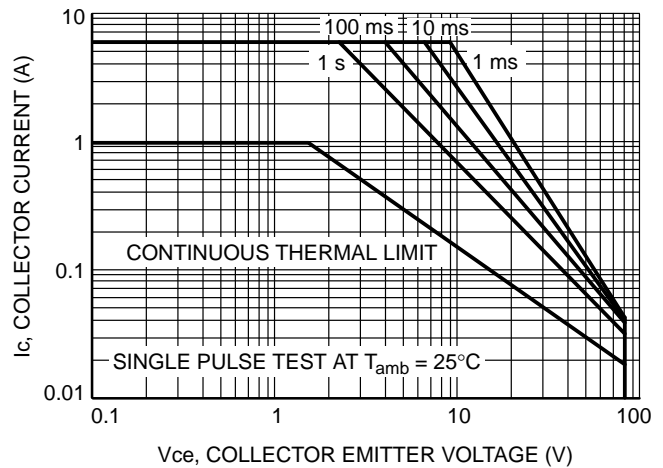
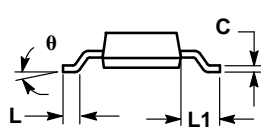
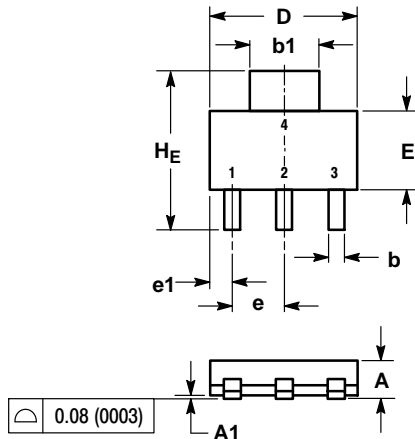

**Figure 12. Standard Operating Area**

# BCP53 Series

## PACKAGE DIMENSIONS

### SOT-223 (TO-261) CASE 318E-04 ISSUE N



- NOTES:
1. DIMENSIONING AND TOLERANCING PER ASME Y14.5M, 1994.
  2. CONTROLLING DIMENSION: INCH.

DIM	MILLIMETERS			INCHES		
	MIN	NOM	MAX	MIN	NOM	MAX
A	1.50	1.63	1.75	0.060	0.064	0.068
A1	0.02	0.06	0.10	0.001	0.002	0.004
b	0.60	0.75	0.89	0.024	0.030	0.035
b1	2.90	3.06	3.20	0.115	0.121	0.126
c	0.24	0.29	0.35	0.009	0.012	0.014
D	6.30	6.50	6.70	0.249	0.256	0.263
E	3.30	3.50	3.70	0.130	0.138	0.145
e	2.20	2.30	2.40	0.087	0.091	0.094
e1	0.85	0.94	1.05	0.033	0.037	0.041
L	0.20	---	40°	0.008	---	40°
L1	1.50	1.75	2.00	0.060	0.069	0.078
HE	6.70	7.00	7.30	0.264	0.276	0.287
θ	-			-		

- STYLE 1:
1. BASE
  2. COLLECTOR
  3. EMITTER
  4. COLLECTOR

### SOLDERING FOOTPRINT\*

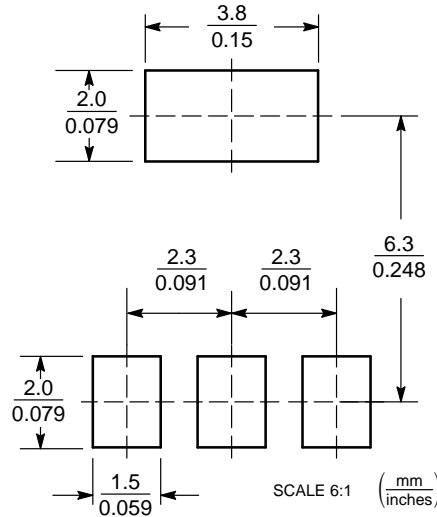

\*For additional information on our Pb-Free strategy and soldering details, please download the ON Semiconductor Soldering and Mounting Techniques Reference Manual, SOLDERRM/D.

ON Semiconductor and are trademarks of Semiconductor Components Industries, LLC dba ON Semiconductor or its subsidiaries in the United States and/or other countries. ON Semiconductor owns the rights to a number of patents, trademarks, copyrights, trade secrets, and other intellectual property. A listing of ON Semiconductor's product/patent coverage may be accessed at [www.onsemi.com/site/pdf/Patent-Marking.pdf](http://www.onsemi.com/site/pdf/Patent-Marking.pdf). ON Semiconductor reserves the right to make changes without further notice to any products herein. ON Semiconductor makes no warranty, representation or guarantee regarding the suitability of its products for any particular purpose, nor does ON Semiconductor assume any liability arising out of the application or use of any product or circuit, and specifically disclaims any and all liability, including without limitation special, consequential or incidental damages. Buyer is responsible for its products and applications using ON Semiconductor products, including compliance with all laws, regulations and safety requirements or standards, regardless of any support or applications information provided by ON Semiconductor. "Typical" parameters which may be provided in ON Semiconductor data sheets and/or specifications can and do vary in different applications and actual performance may vary over time. All operating parameters, including "Typicals" must be validated for each customer application by customer's technical experts. ON Semiconductor does not convey any license under its patent rights nor the rights of others. ON Semiconductor products are not designed, intended, or authorized for use as a critical component in life support systems or any FDA Class 3 medical devices or medical devices with a same or similar classification in a foreign jurisdiction or any devices intended for implantation in the human body. Should Buyer purchase or use ON Semiconductor products for any such unintended or unauthorized application, Buyer shall indemnify and hold ON Semiconductor and its officers, employees, subsidiaries, affiliates, and distributors harmless against all claims, costs, damages, and expenses, and reasonable attorney fees arising out of, directly or indirectly, any claim of personal injury or death associated with such unintended or unauthorized use, even if such claim alleges that ON Semiconductor was negligent regarding the design or manufacture of the part. ON Semiconductor is an Equal Opportunity/Affirmative Action Employer. This literature is subject to all applicable copyright laws and is not for resale in any manner.

### PUBLICATION ORDERING INFORMATION

**LITERATURE FULFILLMENT:**  
Literature Distribution Center for ON Semiconductor  
19521 E. 32nd Pkwy, Aurora, Colorado 80011 USA  
**Phone:** 303-675-2175 or 800-344-3860 Toll Free USA/Canada  
**Fax:** 303-675-2176 or 800-344-3867 Toll Free USA/Canada  
**Email:** [orderlit@onsemi.com](mailto:orderlit@onsemi.com)

**N. American Technical Support:** 800-282-9855 Toll Free  
USA/Canada  
**Europe, Middle East and Africa Technical Support:**  
Phone: 421 33 790 2910

**ON Semiconductor Website:** [www.onsemi.com](http://www.onsemi.com)  
**Order Literature:** <http://www.onsemi.com/orderlit>

For additional information, please contact your local Sales Representative