



RAYSTAR

RAYSTAR Optronics, Inc.
曜凌光電股份有限公司



曜凌光電股份有限公司 Raystar Optronics, Inc.

42881台中市大雅區科雅路25號5樓
5F, No. 25, Keya Road, Daya Dist., Taichung City 42881, Taiwan
T : +886-4-2565-0761 | F : +886-4-2565-0760
sales@raystar-optronics.com | www.raystar-optronics.com

RL0F00050000FGDAASA00

SPECIFICATION

CUSTOMER:

APPROVED BY	
PCB VERSION	
DATE	

FOR CUSTOMER USE ONLY

SALES BY	APPROVED BY	CHECKED BY	PREPARED BY

Release DATE:

TFT Display Inspection Specification: <https://www.raystar-optronics.com/download/products.htm>
Precaution in use of TFT module: <https://www.raystar-optronics.com/download/declaration.htm>

Revision History

VERSION	DATE	REVISED PAGE NO.	Note
0	2021/12/14		First issue
A	2022/01/05	16	Modify the firmware description.
		7	Add more SPEC of PCBA
B	2022/04/15	9	Add PCBA Part number
		15	Add description of default selection

Contents

1. Smart Display Classification Information
2. Summary
3. Product information
4. Contour Drawing
5. Absolute Maximum Ratings
6. Electrical Characteristics
7. BOM
8. Block diagram
9. Interface
10. Reliability
11. Product inspection check list
12. Display Usage
13. Example Screen Layout (Industry application)
14. Example Screen Layout (Vehicle automotive)
15. Example Screen Layout (Medical application)
16. References

1. Smart Display Classification Information

R	L	0F	000500	00F	G	D	AA	S	A	00
①	②	③	④	⑤	⑥	⑦	⑧	⑨	⑩	⑪

①	R: RAYSTAR products									
②	Type: L:Standard K:Customization									
③	Display Type:	Standard:	0H: Character STN 0X: Graphic STN (TAB/COF) 0F: TFT EH: Character OLED EX: OLED (TAB/COF)	0G: Graphic STN 0P: Graphic STN (COG) EG: Graphic OLED EP: OLED (COG)						
		Customization:	DH: Character DN: Graphic ED: OLED	DG: Graphic STN OJ: TFT						
④	Display size: (diagonal) / Display format: (resolution)	Character STN:	e.g., 8x1: 000801 16x2: 001602 24x4: 002404							
		Graphic STN:	e.g., 128x64: 012864 320x240: 320240							
		TFT Size (inch):	000096-0.96" / 000350-3.5" / 000430-4.3" / 000570-5.7" 000700-7.0" / 000800-8.0" / 001020-10.2" / 001210-12.1" (The last two digits are two digits after the decimal point)							
	OLED:	e.g., 128x64: 012864 Customization: 0001XX								
⑤	Serial No:	0A1 ~ 0ZZ	Customization STN: 000							

⑥	Touch Panel Type:	N: Without TP T: RTP G: CTP			
⑦	Model Interface:	A: CAN B: Bluetooth C: Controller Specified D: RS485 E: RS232 F: USART G: Logic I/O	H: HDMI R: Memory Specified N: Ethernet J: Analog I/O K: USB L: WIFI M: Zigbee	X: Combined Y: Proprietary interface	
⑧	Interface Serial No.:	AA ~ ZZ			
⑨	Control Category:	S: Smart Display E: Entry N: Non-specified			
⑩	Special Code:	A ~ Z			
⑪	Model code:	00 ~ ZZ			

2. Summary

5 Inch Smart Display Feature

1. DC 5V working voltage, low power consumption for USB to drive.
2. Self testing after booting function.
3. RS485 communication interface.
4. Built in flash memory, store the font and Object Dictionary Data.
5. Support capacitive touch panel (CTP).
6. Smart Display scenario is slave device display and action from Master Device instruction.
7. Embedded buzzer controlled by Master Device.
8. Demo set HOST can be used on multiple platforms, such as Computer (with USB to RS-485 Dongle), MCU.

3. Product information

3.1 Mechanical Data

Item	Standard Value	Unit
LCD panel	120.7(W)*75.8(H)*4.475	mm
PCB	135.7(W)*82.4(H)*1.6	mm
Housing outline	NA	mm

3.2 General information

Item	Standard Value	Unit
Operating voltage	5	Vdc
Communication Interface	RS485 differential \pm 3.3	Vpp
MCU	STM32F429	N/A
Flash Memory	16	MB
SDRAM Frequency	90	MHz
LCD display size	5.0	inch
Dot Matrix	800 \times 3(RGB) \times 480	dot
Module dimension	120.7(W) \times 75.8(H) \times 4.475	mm
Active area	108(W) \times 64.8 (H)	mm
Dot pitch	0.135(W) \times 0.135(H)	mm
LCD type	TFT, Normally Black, Transmissive	
View Direction	80/80/80/80	
Aspect Ratio	16:9	
With /Without TP	With CTP	
Surface	Glare	

4. Contour Drawing

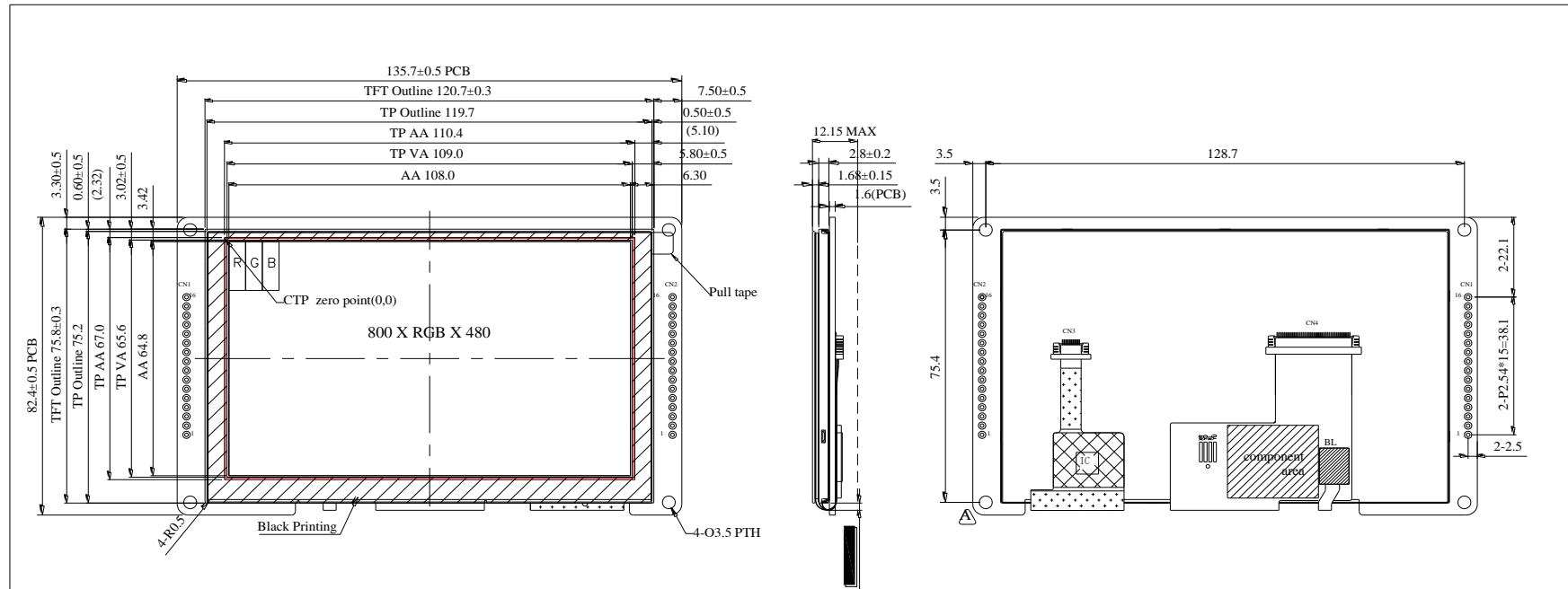

1	Lcd Type	TFT
2	View Angle	80/80/80/80
3	Surface	Glare
4	Screen size	5.0"(diagonal)
5	Display format	800 x RGB x 480
6	Operating Temperature	-30°C ~80°C B
7	Storage Temperature	-30°C ~80°C
8	Active area	108.0(H) x 64.8(V) mm
9	Pixel pitch	0.135(H) x 0.135(V) mm
10	Color arrangement	RGB-STRIFE
11	Brightness	300min. 400typ. cd/m2
12	CTP IC	ILI2130 or equivalent
13	CTP Resolution	16384*16384

CN2	
PIN	SYMBOL
1	VDD3V
2	TAG_SWCLK
3	GND
4	TAG_SWDIO
5	NRST
6	GND

CN1	
PIN	SYMBOL
1	5V
2	GND
3	NC
4	NC
5	GND
6	GND
7	NC
8	NC
9	VDD_5V
10	USART1_RX
11	USART1_TX
12	GND
13	VDD_5V
14	RS485_B
15	RS485_A
16	GND

The non-specified tolerance of dimension is ±0.3 mm .

5. Absolute Maximum Ratings

Item	Symbol	Min	Typ	Max	Unit
Operating Temperature	TOP	-30	—	+80	°C
Storage Temperature	TST	-30	—	+80	°C

Note: Device is subject to be damaged permanently if stresses beyond those absolute maximum ratings listed above
1. Temp. $\leq 60^{\circ}\text{C}$, 90% RH MAX. Temp. $> 60^{\circ}\text{C}$, Absolute humidity shall be less than 90% RH at 60°C

6. Electrical Characteristics

Item	Symbol	Condition	Min	Typ	Max	Unit
Supply Voltage	VCI	—	4.75	5	5.5	V
Supply current	IOVCC	—	3.234	3.30	3.367	mA

7. BOM

Item	Description	Remark
LCM	RFF500F-AWW-DNG	
PCBA	SV10005R000FD00N0100	

8. Block diagram

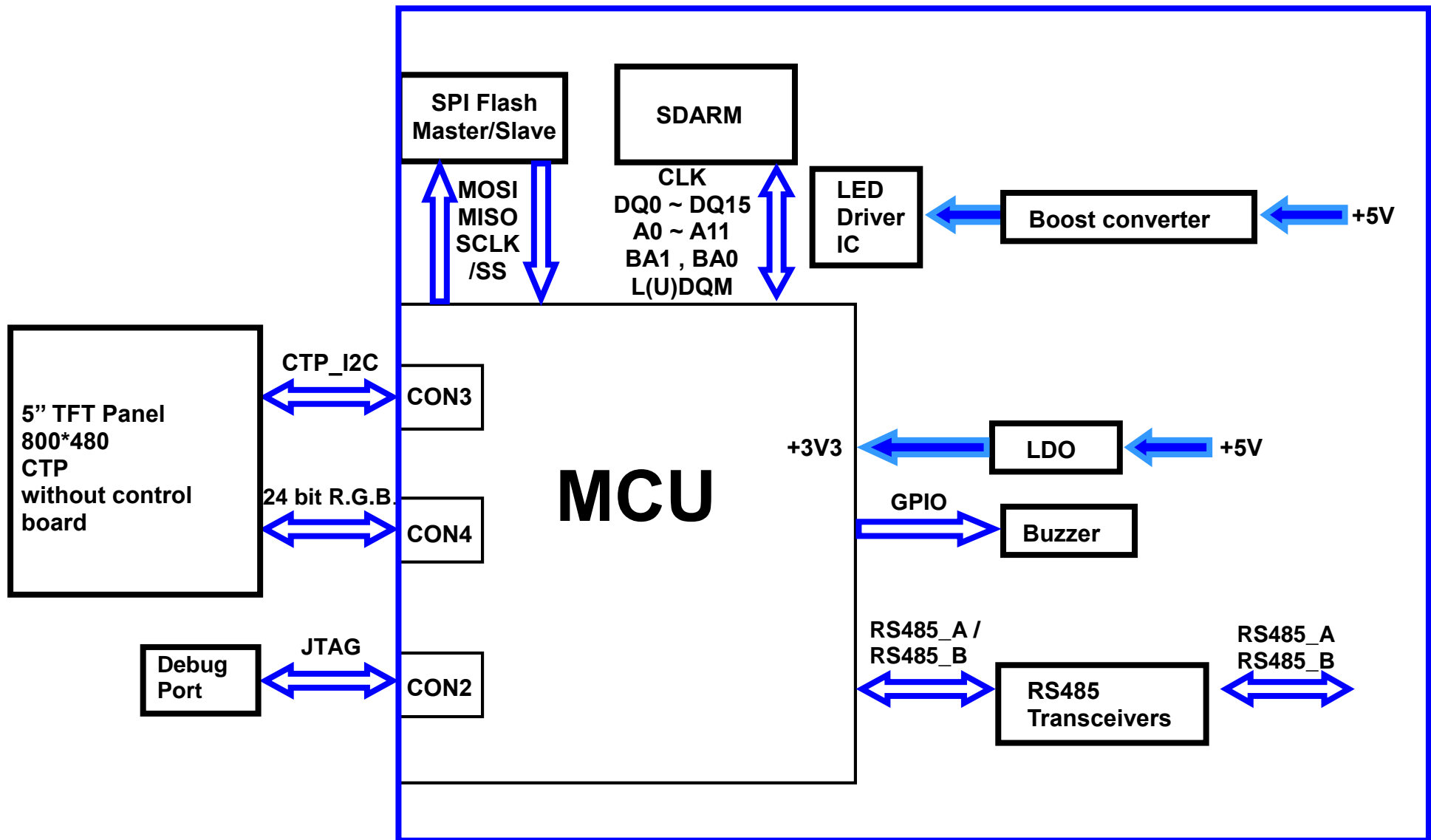

9. Interface

CN1 definition:

Pin	Symbol	Function	Remark
1	+5V	Power supply 5V input	Input
2	GND	Power supply GND input	Input
3	NC	Connection	-
4	NC	Connection	-
5	GND	Power supply GND input	Input
6	GND	Power supply GND input	Input
7	NC	Connection	-
8	NC	Connection	-
9	VDD_5V	5V output for USART interface	Output
10	USART1_RX	USART RX interface	Reserve
11	USART1_TX	USART TX interface	Reserve
12	GND	GND for USART interface	Output
13	VDD_5V	5V output for USART interface	Output
14	RS485_B	RS485 DATA-	I/O
15	RS485_A	RS485 DATA+	I/O
16	GND	Power supply GND input	Input

CN2 definition:

Pin	Symbol	Function	Remark
1	VMCU	3.3V power for JTAG interface	Output
2	JTAG_SWCLK	CLK pin for JTAG interface	Input
3	GND	GND for JTAG interface	Output
4	JTAG_SWDIO	Data pin for JTAG interface	I/O
5	NRST	Reset pin for JTAG interface	Input
6	GND	GND	Output
7-16	NC	Connection	-

10. Reliability

Content of Reliability Test (Wide temperature, -30°C~80°C)

Environmental Test			
Test Item	Content of Test	Test Condition	Note
High Temperature storage	Endurance test applying the high storage temperature for a long time.	80°C 96hrs	2
Low Temperature storage	Endurance test applying the low storage temperature for a long time.	-30°C 96hrs	1,2
High Temperature Operation	Endurance test applying the electric stress (Voltage & Current) and the thermal stress to the element for a long time.	80°C 96hrs	—
Low Temperature Operation	Endurance test applying the electric stress under low temperature for a long time.	-30°C 96hrs	1
High Temperature/ Humidity Operation	The module should be allowed to stand at 40°C,90%RH max	40°C,90%RH 96hrs	1,2
Thermal shock resistance	The sample should be allowed stand the following 10 cycles of operation <div style="text-align: center;"> <p style="margin: 0;">-20°C 25°C 70°C</p> <p style="margin: 0;">30min 5min 30min</p> <p style="margin: 0;">1 cycle</p> </div>	-20°C/70°C 10 cycles	—
Vibration test	Endurance test applying the vibration during transportation and using.	Total fixed amplitude : 1.5mm Vibration Frequency : 10~55Hz One cycle 60 seconds to 3 directions of X,Y,Z for Each 15 minutes	3
Static electricity test	Endurance test applying the electric stress to the terminal.	VS= ±2kV~±6kV(contact), ±2kV~±8kV(air), RS=330Ω CS=150pF 10 times	—

Note1: No dew condensation to be observed.

Note2: The function test shall be conducted after 4 hours storage at the normal Temperature and humidity after remove from the test chamber.

Note3: The packing have to including into the vibration testing.

11. Product inspection check list

Check samples by meter V_{IN} , I_{system}

Item	No 1	No 2	No 3	Note
V_{IN} (V)	5	5	5	
I_{system} (mA)	443	445	447	

Check sample Reliability Test

Item	Result	Note
Thermal shock	—	-20°C/70°C 20 cycles
High Temperature Operation	PASS_20211016	70°C 96hrs
Low Temperature Operation	PASS_20211109	-20°C 96hrs
Static electricity test	—	$V_S = \pm 2kV \sim \pm 6kV$ (contact), $\pm 2kV \sim \pm 8kV$ (air), $R_S = 330\Omega$ $C_S = 150pF$ 10 times
Vibration test	—	Total fixed amplitude : 1.5mm Vibration Frequency : 10~55Hz One cycle 60 seconds to 3 directions of X,Y,Z for Each 15 minutes

- Prepare sets for testing

12. Display Usage

Functional description

Smart Display can be used to display the coordinate, status and data information provided by the connected HOST device. Customers can configure the position coordinates they want to display in normal operation mode (Device Address = 0x7B).

The Display is designed to be easily connected to a controller network, and to use the register type of Holding Register.

Splash Screen

The default splash image is shown below.

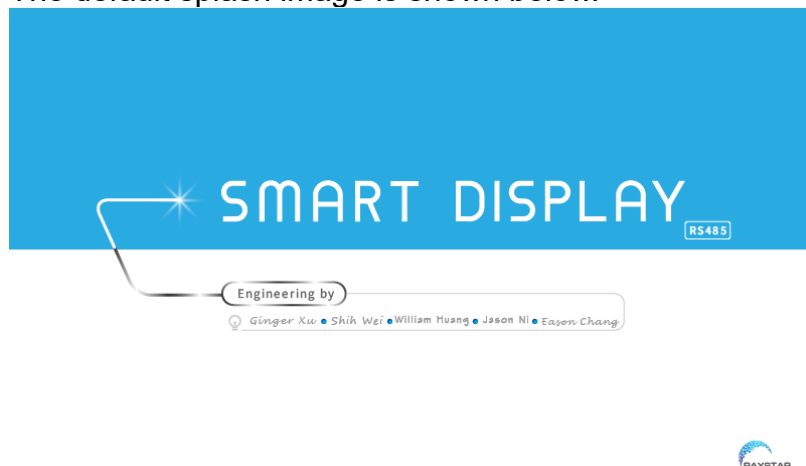

- ✓ This product is produced as a generic product. If you require a custom splash image for your application, contact us to discuss.

Default Selection

Press the preferred application and hold for 3 seconds for the first time power on.



Acquisition of Displayed Data

Smart Display uses the Modbus protocol to get and send the data.

On Config mode, customers can set the coordinates or type of objects; On Display mode, customers can send and get data of objects.

Configuring the Display

Raystar Smart Display RS-485 series offers an out-of-the-box Modbus development experience that will lower customers' development costs and speed time-to-market expectations.

The Smart Display can use wide-temperature are designed to support control applications in harsh operating conditions, which designed to be connected to a variety of different situation combinations, such as automotive, marine, power generation and oil-and-gas.

The Smart Display comes with standard UI objects to get customers project off the ground quickly. If customers need custom UI objects support, our engineers are here to help. Send over your contents in PNG/JPG format, we will send over a new set of UI objects within 3~5 working days.

The Smart Display is defined as a slave device, which is controlled by master device via RS-485 command to render display content on the display screen and return touch event data with protocol objects.

Device Address when Standalone

If the display is powered up standalone, the node id will default to 0x7B.

Configuring the Main Screen

The screen on the display is 800 x 480 pixels.

The co-ordinate system used to specify the location of an item on the screen is shown in the diagram below. The coordinates are (x,y) where 'x' is the horizontal offset from the left, and 'y' is the vertical offset from the top.

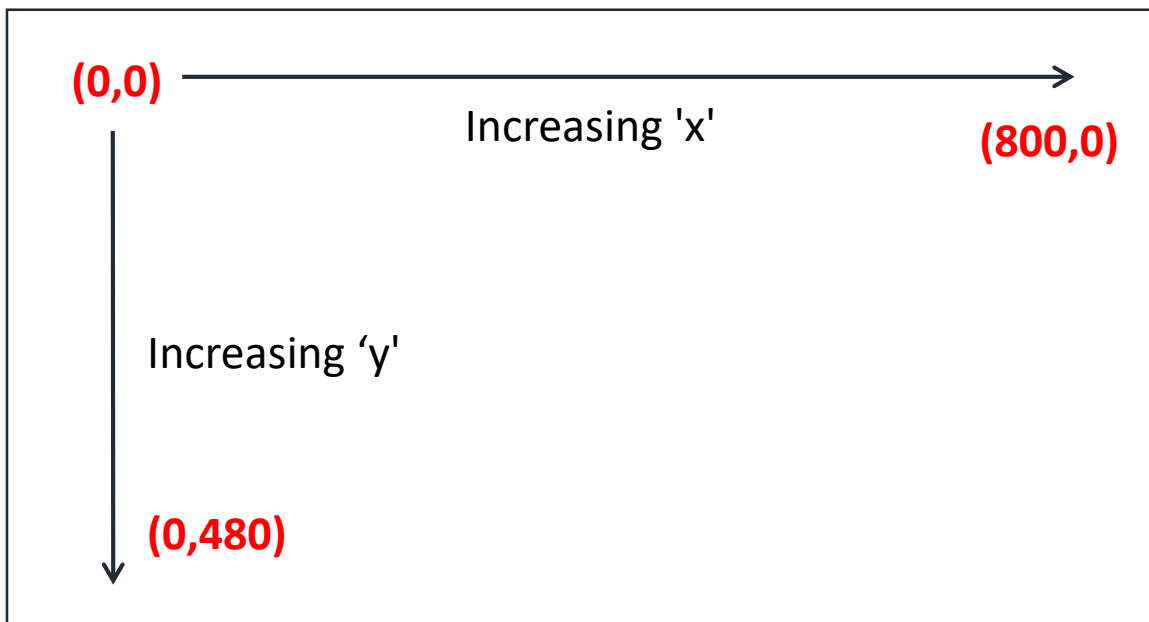

Item Object Dictionary

There are 64 objects entries which are for configuration of the items that can be displayed on the screen in the latest F/W version. Each object fully defines one screen item.

Each object has indexed items that are used to control the coordinates of the object. The exact functionality varies depending on the type of item selected. The template object is shown below:

RLOF00050000FGDAASA00

Object List

The below address is designed to Holding Registers using the MODBUS RTU protocol in RS-485.

This holding Register is defined as 16 bits, can be read/written by using the function code 0x03 (read multiple registers) and function code 0x06 (write a single register) that follow MODBUS RTU protocol.

If you want to learn more about how communication between host and smart display via RS485, please reference the GUI builder communication log.





Address(Dec)	Name	Remark
0	Type	Obj01
1	Reserve	
2	Pos X	
3	Pos Y	
4	Style	
5	Reserve	
6	value1	Insert data
7	value2	Get data
8-57	Buffer	Show strings (Unicode)max to 50 Character
100	Type	Obj02
101	Reserve	
102	Pos X	
103	Pos Y	
104	Style	
105	Reserve	
106	value1	Insert data
107	value2	Get data
108-157	Buffer	Show strings (Unicode)max to 50 Character
...
900	Type	Obj10
901	Reserve	
902	Pos X	
903	Pos Y	
904	Style	
905	Reserve	
906	value1	Insert data
907	value2	Get data
908-957	Buffer	Show strings (Unicode)max to 50 Character



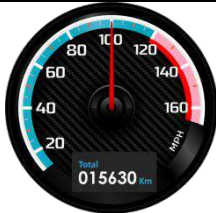

Address(Dec)	Name	Remark
11000	Type	Obj011
11001	Reserve	
11002	Pos X	
11003	Pos Y	
11004	Style	
11005	Reserve	
11006	value1	Insert data
11007	value2	Get data
11008-11057	Buffer	Show strings (Unicode)max to 50 Character
11100	Type	Obj012
11101	Reserve	
11102	Pos X	
11103	Pos Y	

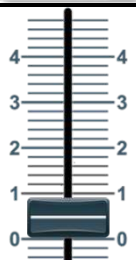
11104	Style	
11105	Reserve	
11106	value1	Insert data
11107	value2	Get data
11108-11057	Buffer	Show strings (Unicode)max to 50 Character
...
16300	Type	Obj064
16301	Reserve	
16302	Pos X	
16303	Pos Y	
16304	Style	
16305	Reserve	
16306	value1	Insert data
16307	value2	Get data
16308-16357	Buffer	Show strings (Unicode)max to 50 Character

Object Type – Type

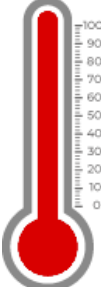
The item type is selected according to the table below:

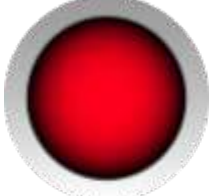
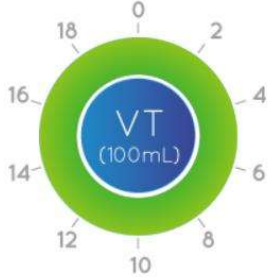
Type Data(Dec)	Description	Example Image
0	No Item This entry is not used	
1	Reserve	
2	Gauge	
3	Reserve	
4	Button	
5	Toggle Button	
6	Vertical Slider	
7	Horizontal Slider	
8	Check Botton	

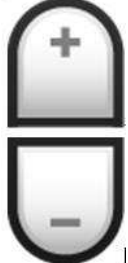
9	Temperature	
10	Battery	
11	Graph	
12	Indicator	
13	CircleProgress	
14	ImageProgress	
15	Radio Button	
16	Reserve	
17	Number String	65535





18	Text String	ABC
19	Reserve	
20	Digital Clock	AM 00:45 2021/09/17
21	Reserve	
22	MultiState	

X and Y position – Pos X/Y

Each item is drawn on screen by setting a draw rectangle. This rectangle is a bounding rectangle sized to fully enclose the item that is being drawn. The co-ordinates specify the position of the top left of this bounding rectangle.

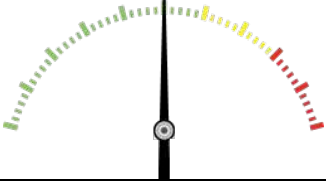
Object Style - Style

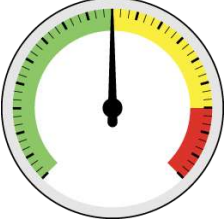



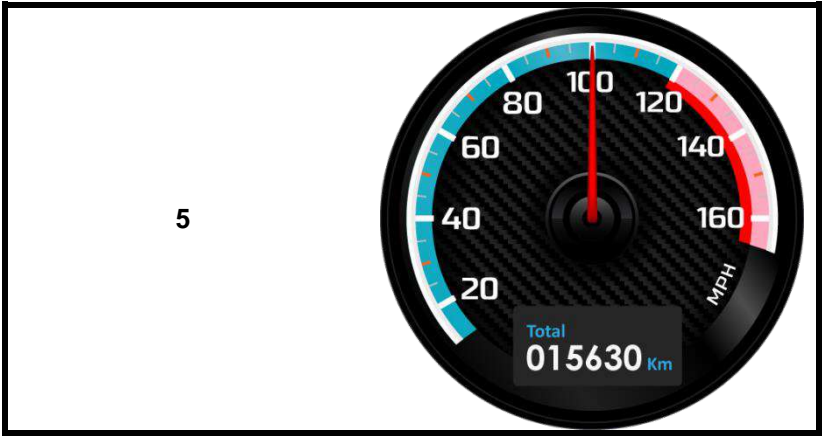

Various types of icons

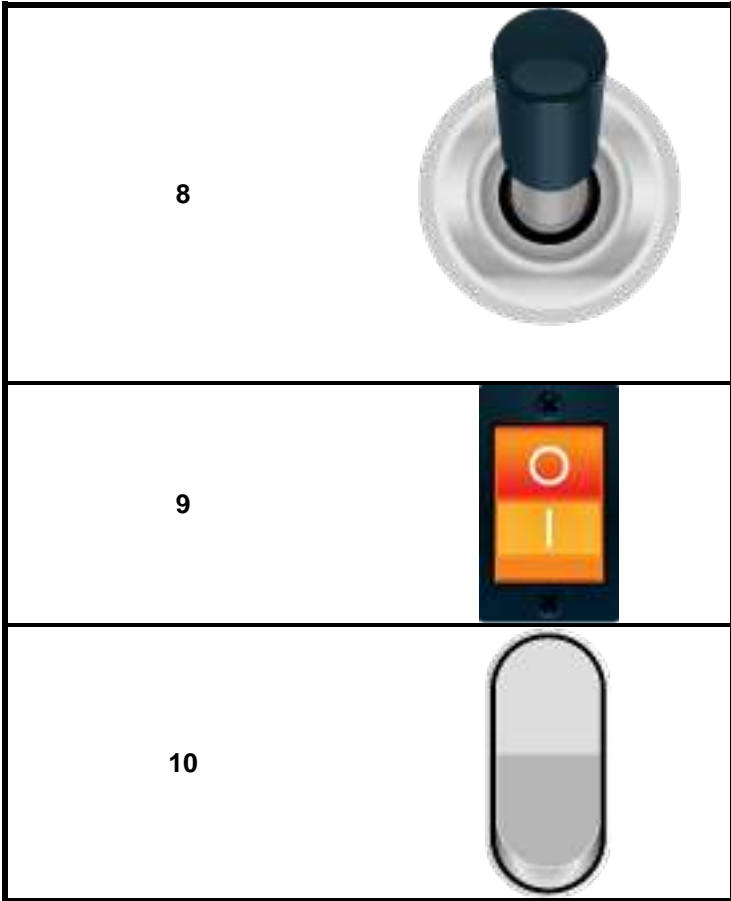
Gauge(Dec)	icon
0	
1	
2	
3	
4	





Button(Dec)	icon
0	
1	
2	
3	
4	
5	
6	
7	

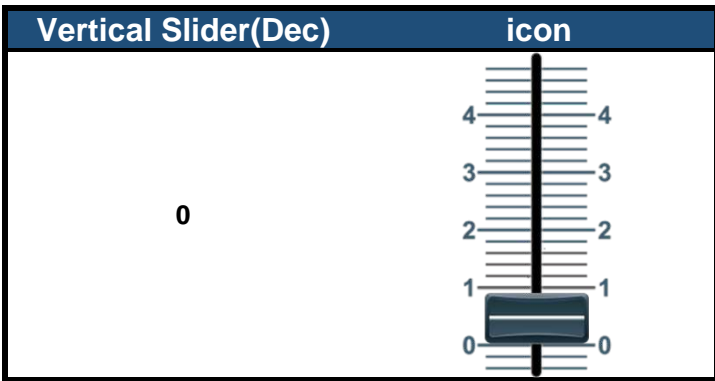
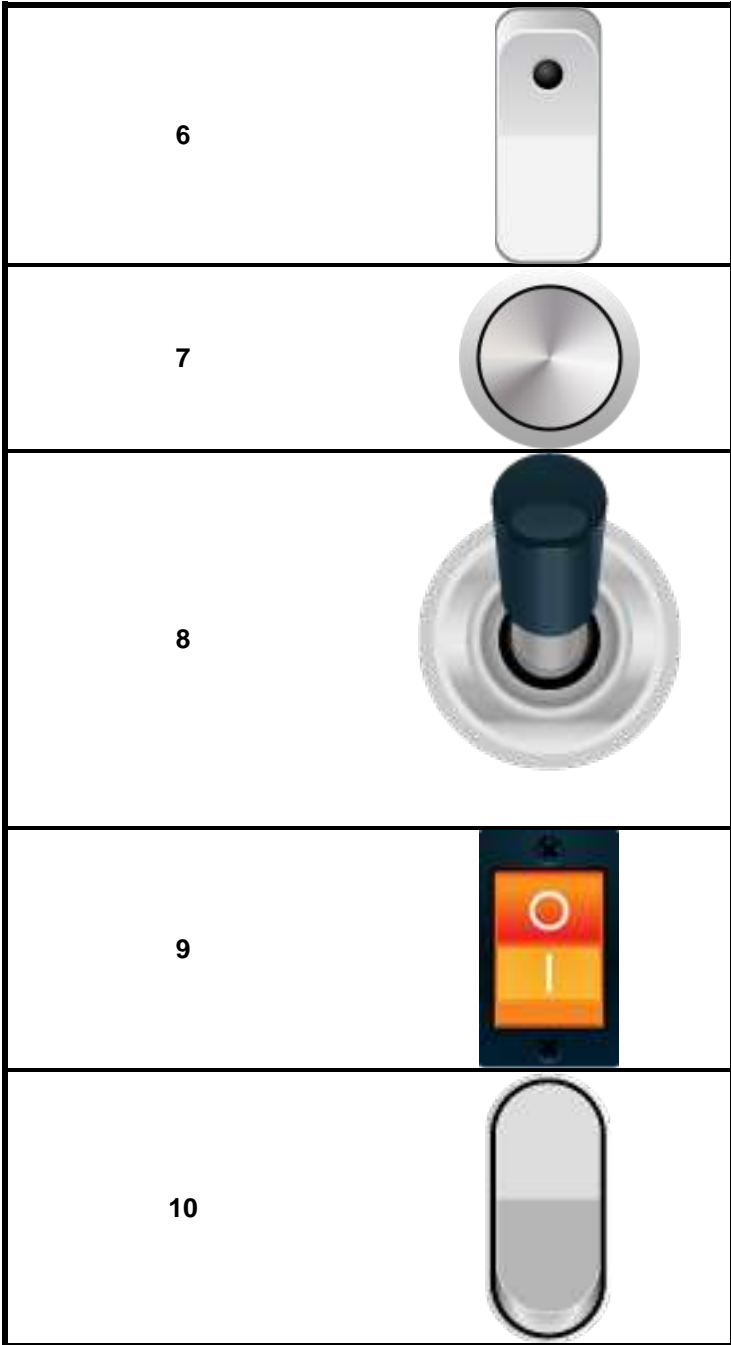

Toggle Button (Dec)	icon
0	
1	
2	
3	
4	
5	



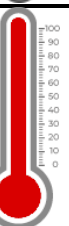
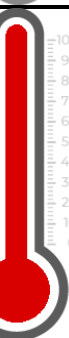
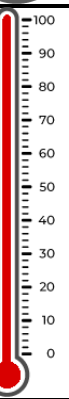

Check Botton (Dec)	icon
0	
1	

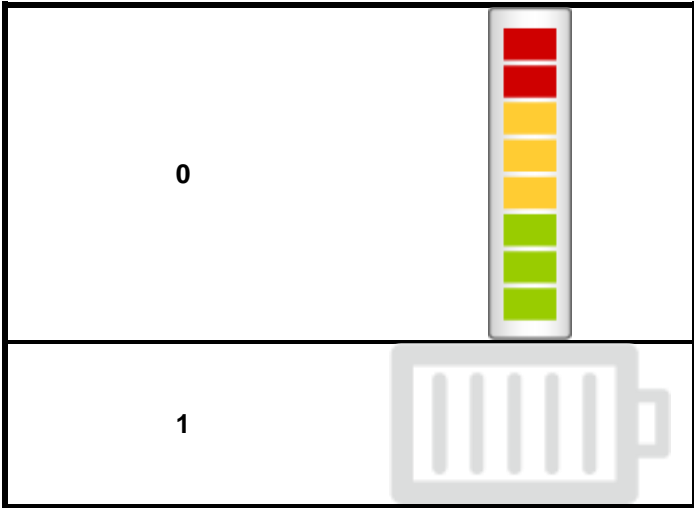

Temperature(Dec)	icon
0	
1	
2	
3	

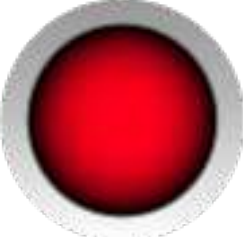
Battery(Dec)	icon
--------------	------

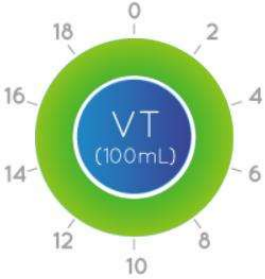
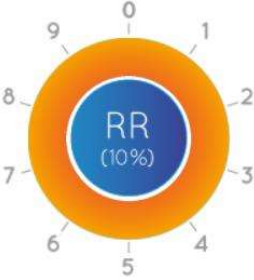

Indicator(Dec)	icon
0	
1	

CircleProgress(Dec)	icon
0	
1	

ImageProgress(Dec)	icon
0	
1	

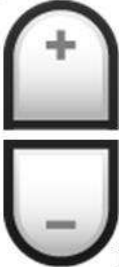
Radio Button (Dec)	icon
0	

Number String(Dec)	icon
0	65535
1	65535
2	65535

Text String(Dec)	icon
0	ABC
1	ABC
2	ABC
3	ABC
4	ABC
5	ABC

Digital Clock (Dec)	icon
0	00:00
1	AM 00:45 2021/09/17

Multi State (Dec)	icon
0	

Transmission and reception of data – Value1 / Value2

HOST sends numeric data to Value1 to control Smart Display objects another HOST receives numerical data from Value2.

Value2 Mapping - Customers can use this register to obtain batch data.

Address(Dec)	Name	Remark
2000~2009	Value2 Mapping	Value2 data from Obj1~Obj10
2010~2063	Value2 Mapping	Value2 data from Obj11~Obj64

Background

Address(Dec)	Name	Remark
2110	Background Index	0~2

Brightness

Address(Dec)	Name	Remark
2111	Brightness	Value(0~100)

Buzzer

Address(Dec)	Name	Remark
2100	Buzzer Cycle	
2101	Buzzer High	
2102	Buzzer Low	
2103	Buzzer Active	Send reverse status to turn on the buzzer. Ex: If the current active bit is true, send false bit and the buzzer is turned on.

Page Number

Address(Dec)	Name	Remark
2112	Jump to the specified page number	
2113	Get Page Count	

Mode

Address(Dec)	Name	Remark
2502	Device State	0: Config Mode 1: Display Mode

13. Example Screen Layout (Industry application)

Example Layout

The screen layout described in this section is intended to demonstrate the settings of screen items that can be used in an industry application situation.

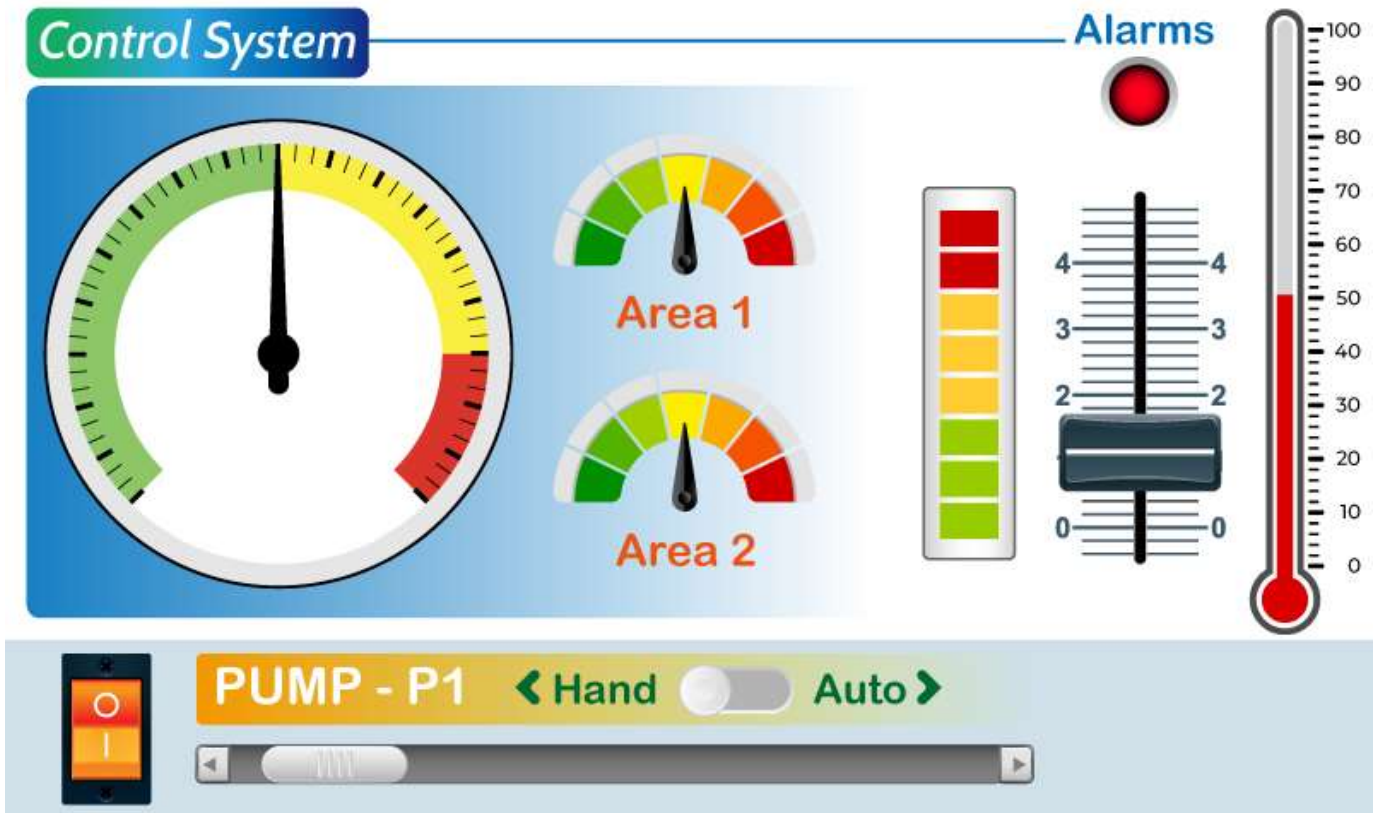

14. Example Screen Layout (Vehicle automotive)

Example Layout

The screen layout described in this section is intended to demonstrate the settings of screen items that can be used in a vehicle automotive situation.

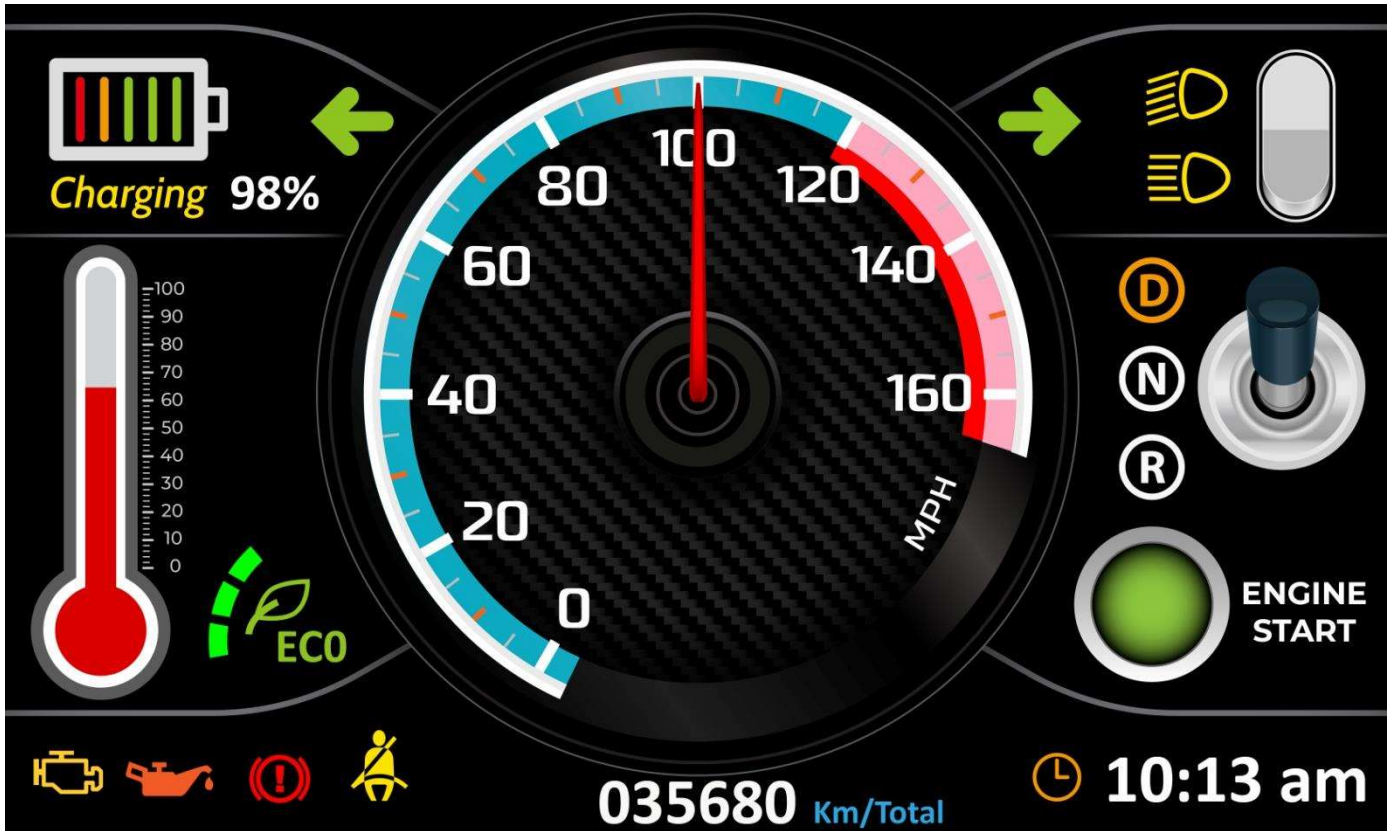

15. Example Screen Layout (Medical application)

Example Layout

The screen layout described in this section is intended to demonstrate the settings of screen items that can be used in a Medical application situation.

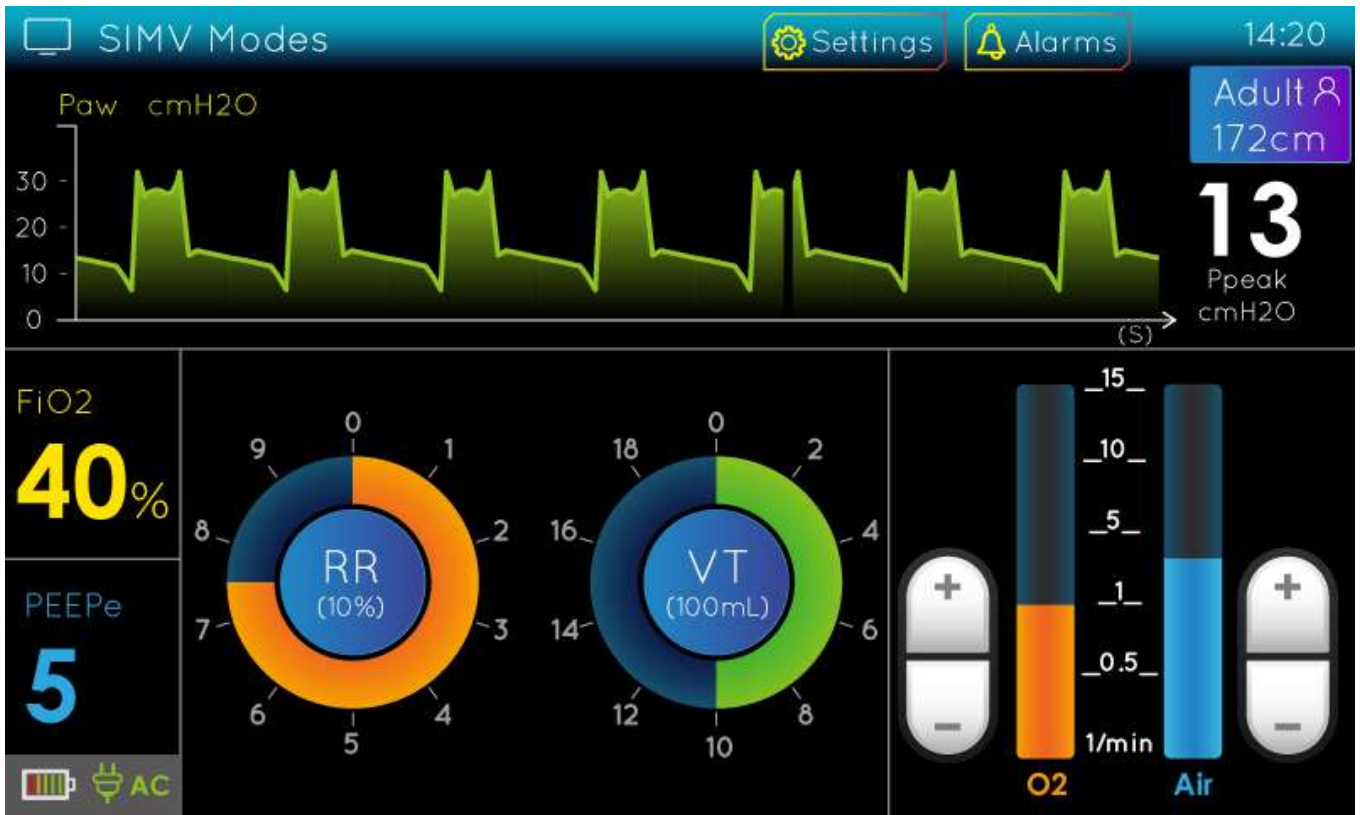

16. References