

Autonics

INDUCTIVE PROXIMITY SENSOR(SQUARE DC 3WIRE)

PSN SERIES

INSTRUCTION MANUAL

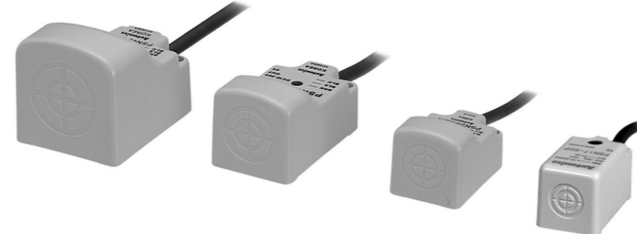

Thank you for choosing our Autonics product.
Please read the following safety considerations before use.

■ Safety Considerations

- ※ Please observe all safety considerations for safe and proper product operation to avoid hazards.
- ※ ⚠ symbol represents caution due to special circumstances in which hazards may occur.
- ⚠ Warning** Failure to follow these instructions may result in serious injury or death.
- ⚠ Caution** Failure to follow these instructions may result in personal injury or product damage.

⚠ Warning

- Fail-safe device must be installed when using the unit with machinery that may cause serious injury or substantial economic loss.** (e.g. nuclear power control, medical equipment, ships, vehicles, railways, aircraft, combustion apparatus, safety equipment, crime/disaster prevention devices, etc.) Failure to follow this instruction may result in fire, personal injury, or economic loss.
- Do not disassemble or modify the unit.** Failure to follow this instruction may result in fire.
- Do not connect, repair, or inspect the unit while connected to a power source.** Failure to follow this instruction may result in fire.
- Check 'Connections' before wiring.** Failure to follow this instruction may result in fire.

⚠ Caution

- Use the unit within the rated specifications.** Failure to follow this instruction may result in fire or product damage.
- Use dry cloth to clean the unit, and do not use water or organic solvent.** Failure to follow this instruction may result in fire.
- Do not use the unit in the place where flammable/explosive/corrosive gas, humidity, direct sunlight, radiant heat, vibration, impact, or salinity may be present.** Failure to follow this instruction may result in fire or explosion.

■ Ordering Information

P SN 17 - 8 DN U F

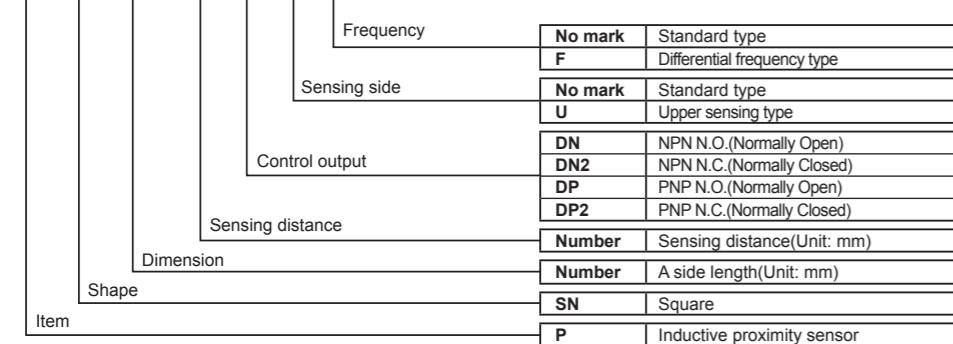

■ Control Output Diagram & Load Operation

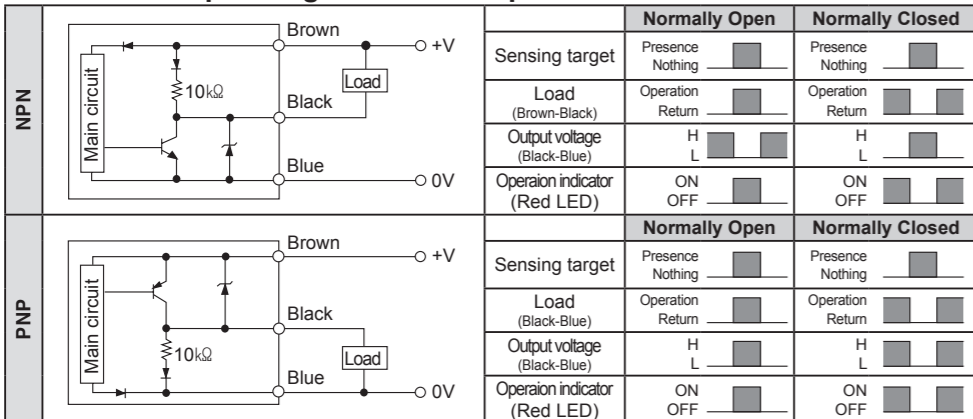

※ The above specifications are subject to change and some models may be discontinued without notice.
※ Be sure to follow cautions written in the instruction manual and the technical descriptions (catalog, homepage).

■ Specifications

Model	PSN17-5DN PSN17-5DP PSN17-5DN2 PSN17-5DP2 PSN17-5DNU PSN17-5DN2U PSN17-5DPU PSN17-5DP2U PSN17-5DN-F PSN17-5DP-F	PSN17-8DN PSN17-8DP PSN17-8DN2 PSN17-8DP2 PSN17-8DNU PSN17-8DN2U PSN17-8DP2U PSN17-8DN-F PSN17-8DP-F PSN17-8DN2-F PSN17-8DP2-F PSN17-8DNU-F PSN17-8DPU-F PSN17-8DN2U-F PSN17-8DP2U-F	PSN25-5DN PSN25-5DP PSN25-5DN2 PSN25-5DP2	PSN30-10DN PSN30-10DP PSN30-10DN2 PSN30-10DP2	PSN30-15DN PSN30-15DP PSN30-15DN2 PSN30-15DP2	PSN40-20DN PSN40-20DP PSN40-20DN2 PSN40-20DP2
Sensing distance	5mm	8mm	5mm	10mm	15mm	20mm
Hysteresis	Max. 10% of sensing distance					
Standard sensing target	18×18×1mm(Iron)	25×25×1mm(Iron)		30×30×1mm(Iron)	45×45×1mm(Iron)	60×60×1mm(Iron)
Setting distance	0 to 3.5mm	0 to 5mm	0 to 3.5mm	0 to 7mm	0 to 10.5mm	0 to 14mm
Power supply (Voltage range)	12-24VDC (=) (10-30VDC =)					
Current consumption	Max. 10mA					
Response frequency ^{※1}	700Hz	200Hz	350Hz	250Hz	200Hz	100Hz
Residual voltage	Max. 1.5V					
Effect by Temp.	Within ±10°C max. of sensing distance at 20°C in temperature range of -25 to 70°C					
Control output	Max. 200mA					
Insulation resistance	Min. 50MΩ(at 500VDC megger)					
Dielectric strength	1,500VAC 50/60Hz for 1minute					
Vibration	1mm amplitude at frequency of 10 to 55Hz in each of X, Y, Z directions for 2 hours					
Shock	500m/s ² (approx. 50G) in X, Y, Z directions for 3 times					
Indicator	Operation indicator(Red LED)					
Environment	Ambient temperature: -25 to 70°C, Storage: -30 to 80°C					
	Ambient humidity: 35 to 95%RH, Storage: 35 to 95%RH					
Protection circuit	Surge protection circuit, Overload & Short protection circuit, Reverse polarity protection circuit					
Protection	IP67(IEC standard)					
Cable ^{※2}	ø4mm, 3 cores, 2m (AWG22, core diameter: 0.08mm, number of cores: 60, insulator diameter: Ø1.25mm)					
Materials	Case: Heat-resistant ABS, Standard cable(Black): Polyvinyl chloride(PVC).					
Approval	CE					
Unit Weight	Approx. 71g	Approx. 70g		Approx. 111g		Approx. 158g

※1: The response frequency is the average value. The sensing condition is using the standard sensing target. The interval is set as 2 times of the standard sensing target, and the setting distance is set for 1/2 of the sensing distance.
 ※2: Do not pull the cable with a tensile strength of 30N or over. It may result in fire due to the broken wire.
 When extending wire, use AWG22 cable or over within 200m.
 ※Environment resistance is rated at no freezing or condensation.

■ Dimensions

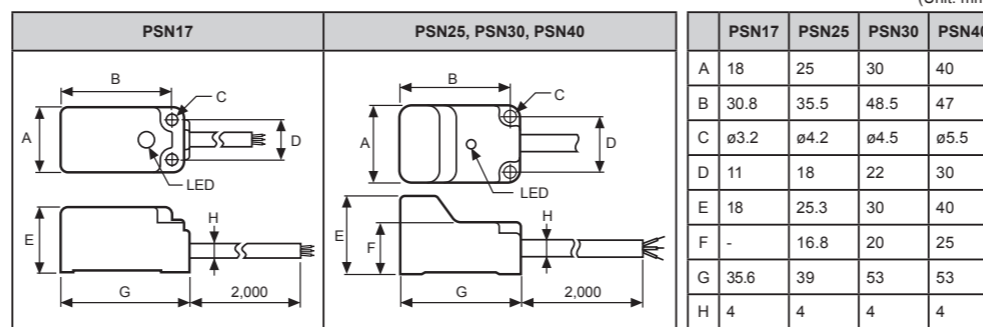

※When installing the product, tighten the screw with a tightening torque of 0.98N·m. (PSN17: 0.49N·m)

○ Bracket

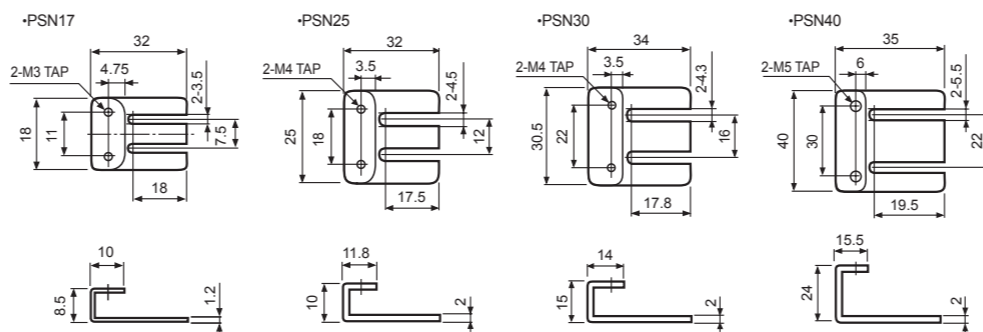

■ Mutual-interference & Influence by Surrounding Metals

○ Mutual-interference

When several proximity sensors are mounted closely, malfunction of sensor may be caused due to mutual interference. Therefore, be sure to keep a minimum distance between the two sensors as below chart.

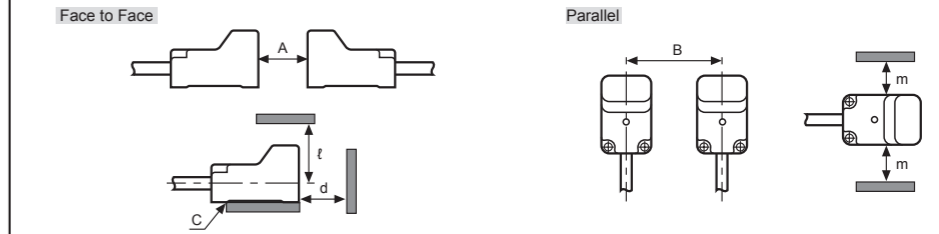

○ Differential frequency type

When install several proximity sensor closely, it may cause malfunction due to mutual interference. Therefore please use differential frequency as below picture.
 ※Differential frequency type is only for PSN17.

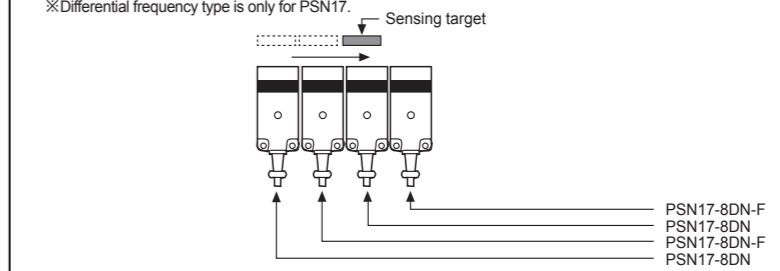

○ Influence by surrounding metals

When sensors are mounted on metallic panel, it is required to protect the sensors from malfunction by any metallic object. Therefore, be sure to keep a minimum distance as below chart.

(Unit: mm)

Item	Model	PSN17		PSN25	PSN30		PSN40
		5mm	8mm		10mm	15mm	
A	30	48	30	60	90	120	
B	36	40	40	50	65	70	
C	5	5	5	5	5	5	
d	15	24	15	30	45	60	
t	24	33	25	30	45	45	
m	18	20	20	25	35	35	

■ Setting Distance

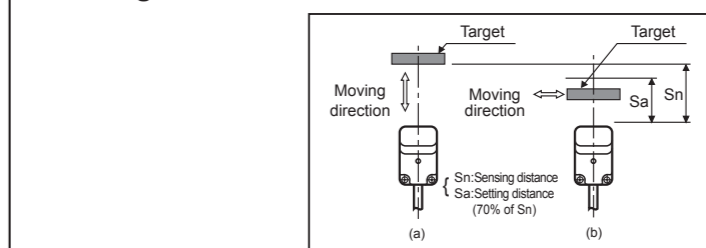

- Sensing distance can be changed by the shape, size or material of the target. Therefore please check the sensing distance as (a), then pass the target within range of setting distance(Sa) as (b).
- Setting distance(Sa) = Sensing distance(Sn) × 70%
 E.g.) PSN30-10DN
 Setting distance(Sa) = 10mm × 0.7 = 7mm

■ Caution during Use

- Follow instructions in 'Cautions during Use'. Otherwise, it may cause unexpected accidents.
- 12-24VDC power supply should be insulated and limited voltage/current or Class 2, SELV power supply device.
- Use the product, after 0.8 sec of supplying power.
- Wire as short as possible and keep away from high voltage lines or power lines, to prevent surge and inductive noise.
 Do not use near the equipment which generates strong magnetic force or high frequency noise (transceiver, etc.).
 In case installing the product near the equipment which generates strong surge (motor, welding machine, etc.), use diode or varistor to remove surge.
- This unit may be used in the following environments.
 - Indoors (in the environment condition rated in 'Specifications')
 - Altitude max. 2,000m
 - Pollution degree 2
 - Installation category II

■ Major Products

- Photoelectric Sensors
- Fiber Optic Sensors
- Door Sensors
- Door Side Sensors
- Area Sensors
- Proximity Sensors
- Pressure Sensors
- Rotary Encoders
- Connectors/Sockets
- Switching Mode Power Supplies
- Control Switches/Lamps/Buzzers
- I/O Terminal Blocks & Cables
- Stepper Motors/Drivers/Motion Controllers
- Temperature Controllers
- Temperature/Humidity Transducers
- SSRs/Power Controllers
- Counters
- Timers
- Panel Meters
- Tachometers/Pulse(Rate) Meters
- Display Units
- Sensor Controllers
- Field Network Devices
- Laser Marking System(Fiber, CO₂, Nd:YAG)
- Laser Welding/Cutting System

Autonics Corporation
<http://www.autonics.com>

HEADQUARTERS:
 18, Bansong-ro 513beon-gil, Haeundae-gu, Busan, South Korea, 48002
 TEL: 82-51-519-3232
 E-mail: sales@autonics.com