



12-24 VOLT  
CONNECTING SYSTEMS  
[www.pro-car.de](http://www.pro-car.de)

# 25 Years

## INNOVATION EXPERTISE PARTNER



For 25 years we have been developing, producing, and distributing high quality connecting systems in the 12-24 Volt range, providing customers with safe connections for on-board electrical systems in cars, trucks, mobile homes, motorbikes and boats.

Adding products, which have been especially developed for mobile applications through modern LED lighting technology as well as USB charging technology.

In year 2011 PRO CAR has acquired the manufacture of Paroli heated laminated fabrics as well as heated carpets- and mats for the mobile leisure market.

For more than 15 years, Paroli heating fabric has been used in the original equipment and retrofitting of underfloor heating in camper vans, caravans, at home and in the workplace, where it has proven its worth.

Customers' needs and demands, and our own experience and ideas keep our company up to date and dynamic, whereupon the quality of our products has the highest priority.

PRO CAR and their business partner are exhibiting at all important national and international trade fairs, which provides us with a wide range of detailed and specific customer information and feedback.

### Our sales programme for OEMs, industry and trade:

- Universal and safety universal plugs 1 A – 16 A for cigarette lighter and standard sockets
- Universal angular plugs with function control for mobile phone network and electrical accessories 7.5 A according to DIN EN ISO 4165
- Socket connectors, twin socket connectors, triple sockets and extension cables with contacts according to DIN ISO EN 4165
- Connectors with large socket connector (internal Ø 21 mm)
- Custom-made assemblies
- Hand, reading and supplementary lights and innovative LED technology
- Electronic alarm devices
- Charging cable with USB connector and USB sockets
- Heating fabric 12 V-230 V for use as a floor heating in recreation vans and caravans
- Heating mats and carpets 12 V and 230 V



For further information visit our web-site: [www.pro-car.de](http://www.pro-car.de)



All items also available in single packaging (SP).





swing-out puller tool



optionally with LED

or without LED



with maze-like strain relief



or with screwed strain relief

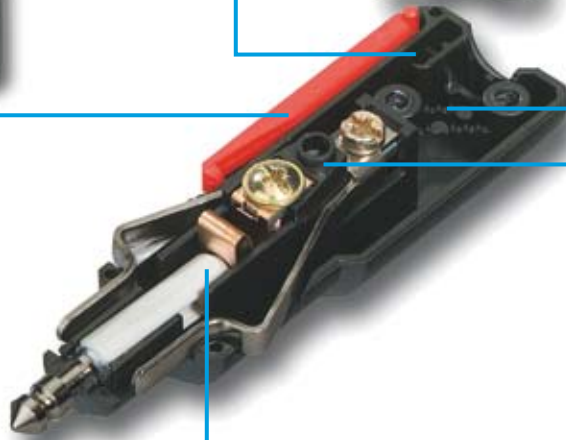

screw terminal for cables up to 2,5 mm<sup>2</sup>

available as safety universal plug fused up to 16 A

or as unfused universal plug



adaptor can be firmly positioned by a bayonet catch hence offering an excellent contact in the cigarette lighter socket





**Universal Plug with screwed strain relief**

8 and 16 A, 12-24 V, fitting for cigarette lighter and standard sockets, screw terminals for cables up to 2.5 mm<sup>2</sup>, adaptor that can be firmly positioned by a bayonet catch, swing-out puller tool.

	BP	SP
	SU = 500	SU = 60
<b>8 A</b>	67711000	67721000
<b>16 A TÜV certified</b>	67711010	67721010



**Universal Plug with maze-like strain relief**

8 and 16 A, 12-24 V, fitting for cigarette lighter and standard sockets, screw terminals for cables up to 2.5 mm<sup>2</sup>, adaptor that can be firmly positioned by a bayonet catch, swing-out puller tool.

	BP	SP
	SU = 500	SU = 60
<b>8 A</b>	67713000	67723000
<b>16 A TÜV certified</b>	67713010	67723010



**Safety Universal Plug with screwed strain relief**

With integrated, interchangeable fuse from 1-16 A, 12-24 V, fitting for cigarette lighter and standard sockets, screw terminals for cables up to 2.5 mm<sup>2</sup>, adaptor that can be firmly positioned by a bayonet catch, swing-out puller tool.

fused	BP	SP
	SU = 500	SU = 60
<b>1 A</b>	67712001	67722001
<b>2 A</b>	67712002	67722002
<b>5 A</b>	67712005	67722005
<b>8 A</b>	67712000	67722000
<b>16 A TÜV certified</b>	67712010	67722010



**Safety Universal Plug with maze-like strain relief**

With integrated, interchangeable fuse from 1-16 A, 12-24 V, fitting for cigarette lighter and standard sockets, screw terminals for cables up to 2.5 mm<sup>2</sup>, adaptor that can be firmly positioned by a bayonet catch, swing-out puller tool.

fused	BP	SP
	SU = 500	SU = 60
<b>1 A</b>	67714001	67724001
<b>2 A</b>	67714002	67724002
<b>5 A</b>	67714005	67724005
<b>8 A</b>	67714000	67724000
<b>16 A TÜV certified</b>	67714010	67724010

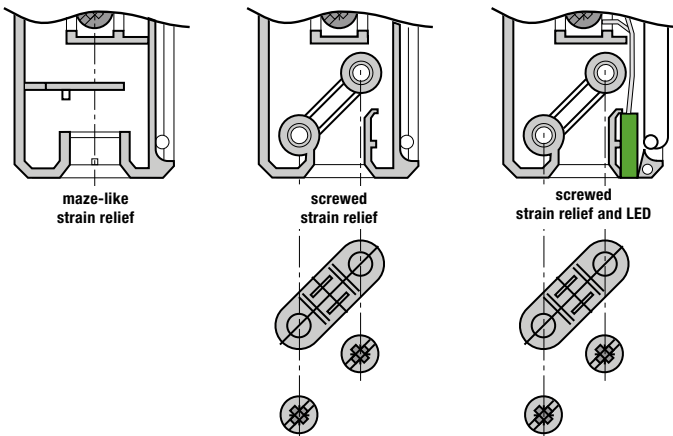



**Universal Plug with screwed strain relief and LED**

8 and 16 A, 12-24 V, fitting for cigarette lighter and standard sockets, screw terminals for cables up to 2.5 mm<sup>2</sup>, adaptor that can be firmly positioned by a bayonet catch, swing-out puller tool.

	BP	SP
	SU = 500	SU = 60
<b>8 A</b>	67711100	67721100
<b>16 A TÜV certified</b>	67711110	67721110



**Buckling Protective Sleeve**

for universal plug and safety universal plug, standard internal Ø 4 mm.

	BP
	80106000

... great contact  
and easy  
to connect!



**Safety Universal Plug with screwed strain relief and LED**

With integrated, interchangeable fuse from 1-16 A, 12-24 V, fitting for cigarette lighter and standard sockets, screw terminals for cables up to 2.5 mm<sup>2</sup>, adaptor that can be firmly positioned by a bayonet catch, swing-out puller tool.

	BP	SP
	SU = 500	SU = 60
<b>fused</b>		
<b>1 A</b>	67712101	67722101
<b>2 A</b>	67712102	67722102
<b>5 A</b>	67712105	67722105
<b>8 A</b>	67712100	67722100
<b>16 A TÜV certified</b>	67712110	67722110



**Power Plug 20 A max. / 12-24 V**

Assembled with cable 2 x 2.5 mm<sup>2</sup>, length 1.2 m. Fitting for cigarette lighter and power sockets. For connecting coffee makers, kettles, heaters etc.

Special versions on request.

	BP	SP
	SU = 100	SU = 60
<b>max. 20 A</b>	67101284	67101285



**Universal Angular Plug**

With operational check by diode. 7.5 A / 12-24 V, adaptor that can be firmly positioned by a bayonet catch, screwed strain relief, cable cross-section max. 1.5 mm<sup>2</sup>, Ø 8 mm, fitting for cigarette lighter and standard sockets according to DIN EN ISO 4165.

	BP	SP
	SU = 100	SU = 20
<b>7,5 A</b>	57730000	57730001



### Bendable Universal Plug

Bendable up to 180°, with screw terminals, with or without strain relief, adaptor that can be firmly positioned by a bayonet catch, 12-24 V, fitting for cigarette lighter and standard sockets.

	BP	SP
	SU = 100	SU = 60
8 A with screwed strain relief	67741000	67741500
8 A without strain relief	67741100	-

### Bendable Safety Universal Plug

Bendable up to 180°, with screw terminals, with or without strain relief, adaptor that can be firmly positioned by a bayonet catch, 12-24 V, fitting for cigarette lighter and standard sockets. With integrated, interchangeable fuse from 1-8 A / 12-24 V.

fused	BP	SP
	SU = 100	SU = 60
1 A with screwed strain relief	67742001	-
2 A with screwed strain relief	67742002	-
8 A with screwed strain relief	67742000	67742500
1 A without strain relief	67742101	-
2 A without strain relief	67742102	-
8 A without strain relief	67742100	-



### Example of use

Offering sufficient space for your electronics.

dimensions for pcb:

- with screwed strain relief = 28.5 x 26.5 x 1.5 mm
- strain relief by prommet = 35.5 x 26.5 x 1.5 mm



### Bendable Universal Plug with Switch

8 A / 12-24 V, with single-pole circuit breaker 8 A, rocker switch imprinted with 0-I. The plug is bendable up to 180°, with screw terminals, adaptor that can be firmly positioned by a bayonet catch, fitting for cigarette lighter and standard sockets.

	BP	SP
	SU = 100	SU = 60
8 A	67746000	67746500

### Bendable Safety Universal Plug with Switch

8 A / 12-24 V, with single-pole circuit breaker 8 A, rocker switch imprinted with 0-I. The plug is bendable up to 180°, with screw terminals, adaptor that can be firmly positioned by a bayonet catch. With integrated, interchangeable fuse 8 A, fitting for cigarette lighter and standard sockets.

fused	BP	SP
	SU = 100	SU = 60
8 A	67747000	67747500



### Bendable Universal Plug with Switch

8 A / 12-24 V, with single-pole circuit breaker 8 A, rocker switch imprinted with 0-I, assembled with cable 2 x 0.75 mm<sup>2</sup>, length 2.0 m. The plug is bendable up to 180°, with screw terminals, adaptor that can be firmly positioned by a bayonet catch, fitting for cigarette lighter and standard sockets.

	BP	SP
	SU = 100	SU = 60
8 A	67745000	67745500

### Bendable Safety Universal Plug with Switch

8 A / 12-24 V, with single-pole circuit breaker 8 A, rocker switch imprinted with 0-I, assembled with cable 2 x 0.75 mm<sup>2</sup>, length 2.0 m. The plug is bendable up to 180°, with screw terminals, adaptor that can be firmly positioned by a bayonet catch. With integrated, interchangeable fuse 8 A, fitting for cigarette lighter and standard sockets.

fused	BP	SP
	SU = 100	SU = 60
8 A	67748000	67748500



### Standard Plug 8 A

With soldering contacts and maze-like strain relief, for connecting any type of 8 A accessory, 12-24 V, fitting for all standard sockets according to DIN EN ISO 4165.

	BP	SP
	SU = 500	SU = 60
<b>8 A</b>	67751000	67751500



### Standard Plug 15 A

With screw terminals, for connecting any type of 15 A accessory, 12-24 V, easy to assemble, optimal contact, fitting for all standard sockets according to DIN EN ISO 4165.

	BP	BP
	SU = 500	SU = 60
<b>15 A</b>	53005000	53005001

... fits well  
great connections!



### Standard Plug 12 A

With screw terminals and strain relief. For connecting any type of 12 A accessory, 12-24 V, fitting for all standard sockets according to DIN EN ISO 4165.

	BP	SP
	SU = 500	SU = 60
<b>12 A</b>	58078300	58078301



### DIN-Socket-Adaptor 16 A

12-24 V Adaptor for use of devices with cigarette lighter plug in standard sockets. Straight type, one side internal Ø 21mm fitting for cigarette lighter plugs, other side fitting for standard sockets according to DIN EN ISO 4165.

	BP	SP
	SU = 200	SU = 60
<b>16 A</b>	67872900	67882900



**DIN-Standard Built-In Socket**

With 6.3 mm flat terminals. Fastening by hexagon nut, fitting for standard and universal plug, internal Ø 12 mm, 16 A / 12-24 V max., TÜV certified and monitored, with contacts according to DIN EN ISO 4165. Port for installation 18 mm.

	BP	SP
	SU = 500	SU = 60
<b>16 A</b>	57607000	57607001



**DIN-Standard Built-In Socket with Mounting Plate**

With 6.3 mm flat terminals. Fastening by hexagon nut, fitting for standard and universal plug, internal Ø 12 mm, 16 A / 12-24 V max., TÜV certified and monitored, with contacts according to DIN EN ISO 4165. Port for installation 18 mm.

	BP	SP
	SU = 500	SU = 60
<b>with protective cap</b>	57607032	57607033
<b>without protective cap</b>	57607030	57607031



**DIN-Standard Built-In Socket with Protective Cap**

Dust and splash-proof version. With 6.3 mm flat terminals. Fastening by hexagon nut, fitting for standard and universal plug, internal Ø 12 mm, 16 A / 12-24 V max., TÜV certified and monitored, with contacts according to DIN EN ISO 4165. Port for installation 18 mm.

	BP	SP
	SU = 500	SU = 60
<b>16 A</b>	57607002	57607003



**DIN-Standard Built-In Socket, Metal, with Protective Cap**

With 6.3 mm flat terminals. Fastening by hexagon nut, fitting for standard and universal plug, internal Ø 12 mm, 16 A / 12-24 V max. Port for installation 18 mm.

	BP	SP
	SU = 100	SU = 60
<b>16 A</b>	53114320	53114321



**DIN Built-In Socket, waterproof**

12-24 V, waterproof to IP 67, cables are waterproof encapsulated, with screw cap, 16 A / 12-24 V max., internal Ø 12 mm, contacts according to DIN EN ISO 4165, ready-made 300 mm cable. Fastening by hexagon nut. Port for installation 18.0 mm. Temperature resistant -40°C to 105°C.

	BP	SP
	SU = 50	SU = 20
<b>16 A</b>	52005000	52005001



**Triple Built-In Socket**

Three standard sockets, 12-24 V, fitting for standard and universal plug. Connection with 6.3 mm flat terminals. Overall load up of all three sockets 16 A / 12-24 V max., internal Ø 12 mm, with contacts according to DIN EN ISO 4165.

	BP	SP
	SU = 100	SU = 60
<b>16 A</b>	57612002	57612003





### Surface Mounted Socket

With 6.3 mm flat terminals, fitting for standard and universal plug, 16 A / 12-24 V max., internal Ø 12 mm, TÜV certified and monitored, with contacts according to DIN EN ISO 4165.

	BP	SP
	SU = 100	SU = 60
<b>16 A</b>	57608000	57608001



### Surface Mounted Socket with Protective Cap

Dust-proof and splash-proof version. With 6.3 mm flat terminals, fitting for standard and universal plug, 16 A / 12-24 V max., internal Ø 12 mm, TÜV certified and monitored, with contacts according to DIN EN ISO 4165.

	BP	SP
	SU = 100	SU = 60
<b>16 A</b>	57608002	57608003



### Surface Mounted Power Socket

12-24 V. Current-carrying capacity: 20 A based on a cable cross section of 2.5 mm<sup>2</sup>, 16 A based on a cable cross section of 1.5 mm<sup>2</sup>. Internal Ø 21 mm, with 6.3 mm flat terminals, fitting for universal plug.

	BP	SP
	SU = 100	SU = 60
<b>12-24 V / max. 20 A</b>	67604000	67614000



### Triple Surface Mounted Power Socket

12-24 V, 20 A max. based on a cable cross section of 2.5 mm<sup>2</sup>, 16 A based on a cable cross section of 1.5 mm<sup>2</sup>. Internal Ø 21 mm. Mounting screws included.

	BP	SP
	SU = 100	SU = 20
<b>12-24 V</b>	67601000	67611000



### Power Socket Connector

12-24 V, 20 A max. based on a cable cross section of 2.5 mm<sup>2</sup>, 16 A based on a cable cross section of 1.5 mm<sup>2</sup>, for constructing overhung connection. Internal Ø 21 mm, with 6.3 mm flat terminals, fitting for universal plug.

	BP	SP
	SU = 100	SU = 60
<b>12-24 V / max. 20 A, with base plate</b>	67604500	67614500



### Triple Power Socket

With universal plug 16 A, connection possible to all cigarette lighter sockets and DIN standard sockets, 12-24 V, 16 A max. with three sockets. Internal Ø 21 mm. Cable 2 x 1.5 mm<sup>2</sup> flat cable. Length 2.0 m.

	BP	SP
	SU = 50	SU = 20
<b>12-24 V / 16 A</b>	67601500	67611500



**Power Socket with screw thread or clamp sleeve**

Designed to operate electrical devices in cars, boats and caravans. Current-carrying capacity 20 A based on a cable cross section of 2.5 mm<sup>2</sup>, 16 A based on a cable cross section of 1.5 mm<sup>2</sup>. Internal Ø 21 mm, port for installation 27.8 mm. Fastening by hexagon nut or clamp sleeve.

	BP	SP
	SU = 160	SU = 60
12-24 V, screw thread black	68040800	68140800
12-24 V, screw thread red	68040810	68140810
12-24 V, screw thread green	68040820	68140820
12 V, clamp sleeve clear, illuminated	68040740	68140740
12 V, clamp sleeve red, illuminated	68040750	68140750
12 V, clamp sleeve green, illuminated	68040760	68140760
24 V, clamp sleeve clear, illuminated	68040770	68140770
24 V, clamp sleeve red, illuminated	68040780	68140780
24 V, clamp sleeve green, illuminated	68040790	68140790
12-24 V, clamp sleeve green, without illuminated	68040860	68140860



**Motorcycle Socket with snap-on lid**

12 V / 10 A, for connecting battery chargers, navigation systems, PDA's and other devices. Fitting for universal and safety universal plug, weather and splash-proof, assembled with approx. 50 cm cable, internal Ø 21 mm.

	BP	SP
	SU = 50	SU = 20
12 V / 10 A	57607050	57607550



**Power Socket with Mounting Plate**

12-24 V with clamp sleeve, without illumination, with mounting plate for front installation in e.g. thick-walled wood panels. Designed to operate electrical devices in cars, boats and mobile homes. Current-carrying capacity 20 A based on a cable cross section of 2.5 mm<sup>2</sup>, 16 A based on a cable cross section of 1.5 mm<sup>2</sup>. Internal Ø 21 mm, port for installation 32 mm. Fastening by clamp sleeve snapped into the mounting plate, length 60 mm, width 45 mm, height 2.2 mm. Mounting screws included.

	BP	SP
	SU = 160	SU = 60
12-24 V, clamp sleeve green, with mounting plate	68041000	68141000



**Cigarette Lighter with screw thread or clamp sleeve**

12 and 24 V. With 6.3 mm flat terminals. Port for installation 27.8 mm. Fastening by hexagon nut. All versions also available for 24 V.

	BP	SP
	SU = 160	SU = 60
12 V, small knob, screw thread black	68031170	68131170
12 V, small knob, screw thread red	68031180	68131180
12 V, small knob, screw thread green	68031190	68131190
12 V, large knob, screw thread black	68031200	68131200
12 V, large knob, screw thread red	68031210	68131210
12 V, large knob, screw thread green	68031220	68131220
12 V, small knob, clamp sleeve clear, illuminated	68031050	68131050
12 V, small knob, clamp sleeve red, illuminated	68031060	68131060
12 V, small knob, clamp sleeve green, illuminated	68031070	68131070
12 V, large knob, clamp sleeve clear, illuminated	68031080	68131080
12 V, large knob, clamp sleeve red, illuminated	68031090	68131090
12 V, large knob, clamp sleeve green, illuminated	68031100	68131100



### Power USB Built-In Socket

12-24 V DC / 5 V DC, 3,000 mA with integrated power voltage converter. For charging and operating sat navs, mobile phones, smart phones, digital cameras, PAD's and devices that are suitable for charging by 5 Volt USB.

Fastening by plastic screw nut, installation dimensions  $\varnothing$  27.8 mm, pre-assembled cable connection approx. 15 cm.

Input voltage 8-34 Volt, E1 certificate, Current consumption < 5 mA, Cable connection 15 cm, Cable cross section 0.5 mm<sup>2</sup>, Panel thickness 2-8 mm, Install dimensions 27.8 mm +/- 0.1 mm, Output current max. 3 A

	BP	SP
	SU = 100	SU = 60
12-24 V, without mounting plate	67331000	67331500
12-24 V, with mounting plate, incl. screws	67332000	67332500



### Power Double USB Socket

12-24 V DC / 5 V DC, 5,000 mA (2 x 2,500 mA) with integrated power voltage converter.

For charging and operating sat navs, mobile phones, smart phones, digital cameras, PAD's and devices that are suitable for charging by 5 Volt USB.

Fastening by plastic screw nut, installation dimensions  $\varnothing$  27.8 mm, pre-assembled cable connection approx. 15 cm.

Input voltage 8-34 Volt, E1 certificate, Current consumption < 5 mA, Cable connection 15 cm, Cable cross section 0.5 mm<sup>2</sup>, Panel thickness 2-8 mm, Install dimensions 27.8 mm +/- 0.1 mm, Output current max. 5 A (2 x 2,500 mA), Output current duration 4.4 A (2 x 2,200 mA)

	BP	SP
	SU = 100	SU = 60
12-24 V, without mounting plate	67321000	67321500
12-24 V, with mounting plate, incl. screws	67322000	67322500



### Power USB Built-In Socket with Cap

12-24 V DC / 5 V DC, 3,000 mA with integrated power voltage converter. For charging and operating sat navs, mobile phones, smart phones, digital cameras, PAD's and devices that are suitable for charging by 5 Volt USB.

Fastening by plastic screw nut, installation dimensions  $\varnothing$  27.8 mm, pre-assembled cable connection appr. 15 cm.

Input voltage 8-34 Volt, E1 certificate, Current consumption < 5 mA, Cable connection 15 cm, Cable cross section 0.5 mm<sup>2</sup>, Panel thickness 2-8 mm, Install dimensions 27.8 mm +/- 0.1 mm, Output current max. 3 A

	BP	SP
	SU = 100	SU = 60
12-24 V, without mounting plate	67331100	67331600
12-24 V, with mounting plate, incl. screws	67332100	67332600



### Power Double USB Socket with Cap

12-24 V DC / 5 V DC, 5,000 mA (2 x 2,500 mA) with integrated power voltage converter.

For charging and operating sat navs, mobile phones, smart phones, digital cameras, PAD's and devices that are suitable for charging by 5 Volt USB.

Fastening by plastic screw nut, installation dimensions  $\varnothing$  27.8 mm, pre-assembled cable connection appr. 15 cm.

Input voltage 8-34 Volt, E1 certificate, Current consumption < 5 mA, Cable connection 15 cm, Cable cross section 0.5 mm<sup>2</sup>, Panel thickness 2-8 mm, Install dimensions 27.8 mm +/- 0.1 mm, Output current max. 5 A (2 x 2,500 mA), Output current duration 4.4 A (2 x 2,200 mA)

	BP	SP
	SU = 100	SU = 60
12-24 V, without mounting plate	67321100	67321600
12-24 V, with mounting plate, incl. screws	67322100	67322600



**Power USB Surface Mounted Socket**

12-24 V DC / 5 V DC, 3,000 mA with integrated power voltage converter. For charging and operating sat navs, mobile phones, smart phones, digital cameras, PAD's and devices that are suitable for charging by 5 Volt USB.

Fastening by two screws. Pre-assembled cable connection approx. 15 cm.

Input voltage 8-34 Volt,  
E1 certificate,  
Current consumption < 5 mA,  
Cable connection 15 cm,  
Cable cross section 0.5 mm<sup>2</sup>,  
Output current max. 3 A

	BP	SP
	SU = 100	SU = 60
<b>12-24 V</b>	67333000	67333500



**Power Double USB Surface Mounted Socket**

12-24 V DC / 5 V DC, 5,000 mA (2 x 2,500 mA) with integrated power voltage converter. For charging and operating sat navs, mobile phones, smart phones, digital cameras, PAD's and devices that are suitable for charging by 5 Volt USB.

Fastening by two screws. Pre-assembled cable connection approx. 15 cm.

Input voltage 8-34 Volt,  
E1 certificate,  
Current consumption < 5 mA,  
Cable connection 15 cm,  
Cable cross section 0.5 mm<sup>2</sup>,  
Output current max. 5 A (2 x 2,500 mA),  
Output current duration 4.4 A (2 x 2,200 mA)

	BP	SP
	SU = 100	SU = 60
<b>12-24 V</b>	67323000	67323500



**Surface Mounted Triple Socket with 2 Power Sockets and 1 Power USB Socket**

Two power sockets for cooling boxes or devices that are suitable to be operated by 12-24 volt.  
Power USB socket 12-24 V DC / 5 V DC, 3,000 mA with integrated power voltage converter.

For charging and operating sat navs, mobile phones, smart phones, digital cameras, PAD's and devices that are suitable for charging by 5 Volt USB. Fastening by two screws. Pre-assembled cable connection approx. 15 cm.

Input voltage 8-34 Volt, E1 certificate,  
Current consumption < 5 mA,  
Cable connection 15 cm,  
Cable cross section 0.5 mm<sup>2</sup>,  
Output current max. 3 A

	BP	SP
	SU = 100	SU = 20
<b>12-24 V</b>	67334000	67334500



**Surface Mounted Triple Socket with 2 Power Sockets and 1 Power Double USB Socket**

Two power sockets for cooling boxes or devices that are suitable to be operated by 12-24 volt.  
Power Double USB socket 12-24 V DC / 5 V DC, 5,000 mA (2 x 2,500 mA) with integrated power voltage converter.

For charging and operating sat navs, mobile phones, smart phones, digital cameras, PAD's and devices that are suitable for charging by 5 Volt USB. Fastening by two screws. Pre-assembled cable connection approx. 15 cm.

Input voltage 8-34 Volt, E1 certificate,  
Current consumption < 5 mA,  
Cable connection 15 cm,  
Cable cross section 0.5 mm<sup>2</sup>,  
Output current max. 5 A (2 x 2,500 mA),  
Output current duration 4.4 A (2 x 2,200 mA)

	BP	SP
	SU = 100	SU = 20
<b>12-24 V</b>	67324000	67324500



**Triple Socket with 2 Power Sockets and 1 Power USB Socket**

Two power sockets for cooling boxes or devices that are suitable to be operated by 12-24 volt.  
 Power USB socket 12-24 V DC / 5 V DC, 3,000 mA with integrated power voltage converter.  
 For charging and operating sat navs, mobile phones, smart phones, digital cameras, PAD's and devices that are suitable for charging by 5 Volt USB.  
 Fastening by two screws.  
 Connection with universal plug fits in cigarette lighter and standard sockets, cable length 2 m.

Input voltage 8-34 Volt,  
 E1 certificate,  
 Current consumption < 5 mA,  
 Output current max. 3 A

	BP	SP
	SU = 50	SU = 20
<b>12-24 V</b>	67335000	67335500



**Triple Socket with 2 Power Sockets and 1 Power Double USB Socket**

Two power sockets for cooling boxes or devices that are suitable to be operated by 12-24 volt.  
 Power Double USB socket 12-24 V DC / 5 V DC, 5,000 mA (2 x 2,500 mA) with integrated power voltage converter.  
 For charging and operating sat navs, mobile phones, smart phones, digital cameras, PAD's and devices that are suitable for charging by 5 Volt USB.  
 Fastening by two screws.  
 Connection with universal plug fits in cigarette lighter and standard sockets, cable length 2 m.

Input voltage 8-34 Volt,  
 E1 certificate,  
 Current consumption < 5 mA,  
 Output current max. 5 A (2 x 2,500 mA),  
 Output current duration 4,4 A (2 x 2,200 mA)

	BP	SP
	SU = 50	SU = 20
<b>12-24 V</b>	67325000	67325500



**Bendable Double USB Charging Plug**

12-24 V DC / 5 V DC 5,000 mA (2 x 2,500 mA) for charging and operating mobile phones, sat navs, MP3 players, digital cameras, tablets and other devices that are suitable for charging by 5 V USB.  
 Connection possible to all cigarette lighter sockets and DIN standard sockets at 12-24 V electric circuit of cars, caravans and boats.  
 Input voltage 8-34 Volt, E1 certificate, Output current max. 5 A (2 x 2,500 mA),  
 Output current duration 4,4 A (2 x 2,200 mA)

	BP	SP
	SU = 100	SU = 60
<b>12-24 V</b>	67302100	67302500

... mature technology  
 for original equipment!

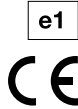

**Charging Cable with Micro USB Plug**

12-24 V, output 5 V, 2,000 mA. For charging and operating sat navs, mobile phones, smart phones, PDAs, digital cameras and devices that are suitable for charging by 5 V USB. With high-performance flyback converter and integrated protection against short-circuit, polarity reversal and overload. Fitting for cigarette lighter and standard socket by using an up to 180° bendable universal plug, cable length approx. 1.80 m.

	BP	SP
	SU = 100	SU = 60
<b>12-24 V</b>	67303000	67303100

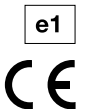

**Charging Cable with Mini USB Plug**

12-24 V, output 5 V, 2,000 mA. For charging and operating sat navs, mobile phones, smart phones, PDAs, digital cameras and devices that are suitable for charging by 5 V USB. With high-performance flyback converter and integrated protection against short-circuit, polarity reversal and overload. Fitting for cigarette lighter and standard socket by using an up to 180° bendable universal plug, cable length approx. 1.80 m.

	BP	SP
	SU = 100	SU = 60
<b>12-24 V</b>	67854800	67864800

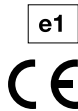

**Charging Cable with Micro USB Plug for Motorbikes**

12-24 V / 5 V 2,000 mA. For charging and operating sat navs, mobile phones, smart phones, PDAs, digital cameras and devices that are suitable for charging by 5 V. With high-performance flyback converter and integrated protection against short-circuit, polarity reversal and overload.

	BP	SP
	SU = 100	SU = 60
<b>12-24 V</b>	68302550	68302650

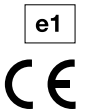

**Charging Cable with Mini USB Plug for Motorbikes**

12-24 V / 5 V 2,000 mA. For charging and operating sat navs, mobile phones, smart phones, PDAs, digital cameras and devices that are suitable for charging by 5 V. With high-performance flyback converter and integrated protection against short-circuit, polarity reversal and overload.

	BP	SP
	SU = 100	SU = 60
<b>12-24 V</b>	68302500	68302600



**USB Extension Cable**

With 2 A safety universal plug, input voltage 12 V battery power, output voltage USB 5 V DC 1,000 mA. For charging and operating sat navs, mobile phones, smart phones and devices that are suitable for charging by 5 Volt USB.

	BP	SP
	SU = 100	SU = 60
<b>12 V</b>	68302050	68302150



**USB Charger Connector 5 V with Protective Cover**

Input voltage 12 V battery power / output voltage USB 5 V DC 1,000 mA. For charging and operating sat navs, mobile phones, smart phones and devices that are suitable for charging by 5 Volt USB.

	BP	SP
	SU = 100	SU = 60
<b>12 V</b>	68302010	68302110



**Extension Cable**

2 x 0.75 mm<sup>2</sup> helix cable. Length 0.6 m to 3.0 m.  
With 8 A safety universal plug (integrated fuse) and socket connector, internal Ø 21 mm, 12-24 V.

	BP	SP
	SU = 100	SU = 20
<b>8 A</b>	67818100	67828100



**Extension Cable**

2 x 0.75 mm<sup>2</sup> flat cable.  
With 8 A safety universal plug (integrated fuse) and socket connector, internal Ø 21 mm, 12-24 V.

	BP	SP
	SU = 100	SU = 20
<b>8 A, cable length 4.0 m</b>	67814100	67824100
<b>8 A, cable length 1.8 m</b>	67814110	67824110



**Extension Cable**

2 x 0.75 mm<sup>2</sup> flat cable. Length 4.0 m. With 8 A safety universal plug (integrated fuse) and fracture-proof socket connector with contacts according to DIN EN ISO 4165, fitting for standard and universal plug.

	BP	SP
	SU = 100	SU = 20
<b>8 A</b>	67814000	67824000



**Connector**

8 A, internal Ø 21 mm, with 1.0 m feeder and crocodile clips.

	BP	SP
	SU = 150	SU = 60
<b>8 A</b>	67874000	67884000



**Helix Cable**

2 x 0.75 mm<sup>2</sup> helix cable. Length 0.6 m to 3.0 m. With 8 A safety universal plug (integrated fuse) or universal plug. Standard version 8 A. Special versions on request.

	BP	SP
	SU = 100	SU = 20
with safety universal plug 8 A	67838000	67848000
with universal plug 8 A	67837000	67847000



**Flat Cable**

2 x 0.75 mm<sup>2</sup> flat cable. Length 4.0 m. With 8 A safety universal plug (integrated fuse) or universal plug. Standard version 8 A. Special versions on request.

	BP	SP
	VSU = 100	SU = 60
with safety universal plug 8 A	67834000	67844000
with universal plug 8 A	67833000	67843000



**Flat Cable**

2 x 0.75 mm<sup>2</sup> flat cable. Length 1.8 m. With socket connector, internal Ø 21 mm, 12-24 V, 8 A max.

	BP	SP
	SU = 150	SU = 20
<b>8 A</b>	67877000	67887000



**Helix Cable**

2 x 0.75 mm<sup>2</sup> helix cable. Length 0.6 m to 3.0 m. With socket connector, internal Ø 21 mm, 12-24 V, 8 A max

	BP	SP
	SU = 100	SU = 20
<b>8 A</b>	67878000	67888000



**Adaptor**

With standard plug and socket connector, internal Ø 21 mm, 12-24 V, 8 A max., 2 x 0.75 mm<sup>2</sup> flat cable, length 0.25 m.

	BP	SP
	SU = 200	SU = 60
<b>8 A</b>	67872000	67882000



**Adaptor with Power Plug**

With socket connector, internal Ø 12 mm, according to DIN EN ISO 4165, 12-24 V, 16 A max. Flat cable 2 x 1.5 mm<sup>2</sup>, length 0.25 m.

	BP	SP
	SU = 200	SU = 60
<b>16 A</b>	67801000	67801500

... manufacturing  
and trade!



**Socket Connector**

To install individual extensions for supplying power to electric accessories and lights, 16 A / 12-24 V max., with contacts according to DIN EN ISO 4165.

	BP	SP
	SU = 100	SU = 60
<b>16 A</b>	57620000	57620001





### Twin Socket Connector

With two standard sockets to connect two electric accessories, flexible connection to the board system using the TÜV certified safety universal plug with interchangeable 16 A fuse, with contacts according to DIN EN ISO 4165.

	BP	SP
	SU = 50	SU = 20
<b>16 A</b>	67652000	67662000



### Power Twin Socket Connector

With universal plug 16 A, permits connection in all cigarette lighters sockets and DIN standard sockets, 12-24 V, max. 16 A with two socket-connectors, internal Ø 21mm. Sturdy design.

	BP	SP
	SU = 60	SU = 20
<b>16 A</b>	67654000	67664000



### Twin Socket Connector

Connection is possible in all sockets for cigarette lighters, two large sockets, internal Ø 21 mm, 12-24 V, 2 x 8 A max. Integrated interchangeable 16 A fuse. 2 x 0.75 mm<sup>2</sup> flat cable, length 0.25 m.

	BP	SP
	SU = 100	SU = 20
<b>16 A</b>	67879000	67889000



### Triple Socket Connector

3 x 5 A, 12-24 V, for operating 3 consumers at the same time with 12-24 Volt plugs in cars, mobile homes, trucks and boats.

Three large socket connectors, internal Ø 21 mm, sturdy version, max. overall load 3 x 5 A.

Fits standard and cigarette lighter sockets when used with red adapter.

	BP	SP
	SU = 100	SU = 20
<b>3 x 5 A</b>	67879050	67889050



### Appliance Cable 2 A

Safety universal plug 2 A assembled with cable 2 x 0.4 mm<sup>2</sup>, length 2 m and DC connector, angled.

	BP	SP
	SU = 200	SU = 60
DC connector 2.1 x 5.5 mm	67854900	67864900
DC connector 2.5 x 5.5 mm	67854910	67864910



### Appliance Cable 8 A

Safety universal plug 8 A assembled with cable 2 x 0.75 mm<sup>2</sup>, length 2 m and DC connector, straight.

	BP	SP
	SU = 200	SU = 60
DC connector 2.1 x 5.5 mm	67854930	67864930
DC connector 2.5 x 5.5 mm	67854920	67864920



**Battery Control**

Protects the battery from excessive discharge caused by electrical appliances such as coolboxes, seat heatings, fans, etc. by automatic cut-out of the power supply. Renewed cut-in with the return of normal voltage conditions. Fitting for cigarette lighter and standard socket, with LED operational check and short circuit protection. 1.0 m feeder with connector, internal Ø 21 mm, bendable and therefore adjustable to various space conditions around the cigarette lighter.

rated voltage 12 V, operation current 8 A, cut-out voltage 11.5 +/- 0.2 V, cut-in voltage 12.6 +/- 0.2 V, natural current consumption ON/OFF 20/5 mA

	BP	SP
	SU = 100	SU = 10
<b>12 V / 8 A</b>	67301000	67301100



**Dimmer 12 Volt DC and 12/24 Volt DC**

Automatic switching between 12 V and 24 V operation. Regulates from 1.5 W up to 140 W 12 V DC and up to 280 W in 24 V DC systems. The dimmer is equipped with a unique output limiter, which maximizes the output to the nominal value for 12 and 24 V lamps and with a constant lighting feature. Short-circuit proof and protected against overloading, overvoltage, overtemperature and faulty connection. Dimensions 60 x 60 x 35 mm, opening for installation Ø 46 mm.

	Volt	Watt	SP
			SU = 50
<b>white</b>	12 V	70 W	50021000
<b>brown</b>	12 V	70 W	50021010
<b>black</b>	12 V	70 W	50021020
<b>white</b>	12 / 24 V	max. 140 / 280 W	50022000
<b>brown</b>	12 / 24 V	max. 140 / 280 W	50022010
<b>black</b>	12 / 24 V	max. 140 / 280 W	50022020

Further colors on request.

... electronics  
for your safety!



**k.o.-Gasalarm 12-24 Volt**

The protection against attacks with narcotic gases in mobile homes, cars and trucks.

Warning by loud signal, long before the gas effects.

- warns for narcotic gases
- with 1.8 m cable and bendable universal plug with switch for multiple use in 12 V sockets for cigarette lighter and standard built-in sockets
- audible and optical signal
- dimensions 130 x 75 x 40 mm
- wall mounting included

	SP
	SU = 50
<b>12-24 V</b>	52002005



**Voltage Converter**

24 V DC / 12 V DC, with 1.2 m connection cable. Allows the use of your 12 V cool box in your truck or boat. The voltage converter simply plugs in between the on-board outlet and any 12 V 60 W device - not just cool boxes.

The Pro Car voltage converter is ideal for using portable navigation systems, CD players, television sets, electric mugs, etc.

Output power plug, internal Ø 21 mm, 72 W (120 W short time), cool current switch mode design with 88% efficiency level, low quiescent current (< 30 mA), internal protection against over-load, voltage peaks and over-heating.

	SP
	SU = 10
<b>24 V</b>	68305000



### Reading Light „Pilot Light“

Ready for use without assembly. Light unit with slide switch, antiglare screen, integrated reflector, flexible arm moveable in all directions and safety universal plug. With integrated 8 A fuse to protect the board system, according to DIN EN ISO 4165. Connection to cigarette lighter and standard sockets without any problems.

	BP	SP
	SU = 100	SU = 60
<b>12 V / 10 W</b>	57406005	57406006



### Supplementary Light „Backseat Light“

8 A, best as reading light in the passenger car's backseat, ideal for boats and caravans as well. Easy assembly by use of the enclosed assembly kit. Light unit with slide switch, antiglare screen and integrated reflector. Flexible light arm moveable in all directions.

	BP	SP
	SU = 50	SU = 20
<b>12 V / 10 W</b>	57405002	57405003



### Superlux Halogen Hand and Reading Light

All-round light for cars, boats and caravans. 12 V / 10 W halogen incandescent lamp and computer calculated reflector, optimal antiglare light distribution by prismatic lens, helix cable 0.6 to 3.0 m, safety universal plug, 8 A.

	BP	SP
	SU = 50	SU = 20
<b>12 V / 10 W</b>	57415002	57415001



Example of use  
spot not included in delivery!



### Power LED illuminant

with G4 pin base on the side, 1.5 W. 12-24 V DC / 12 V AC, Ø 30 mm, Light-color warm-white 2,700 K. Keeps stable at voltage 9-28 V DC / 9-20 V AC.

	BP	SP
	SU = 100	SU = 60
<b>12-24 V</b>	57429010	57429060



### Ambiance LED round

8-30 V battery current / 1 W. Flat, all-purpose LED light. Easy installation with glue or screws. Can be used in cars, boats and mobile homes. When used at home, a 230 V power supply unit for LEDs can be connected. Measurements Ø 52 mm x 6 mm, light color warm-white, 3,200 K, housing plastic with silver coated frame.

	BP	SP
	VKE = 50	VKE = 20
<b>1 W</b>	57402000	57402500



### Ambiance LED square

8-30 V battery current / 1 W. Flat, all-purpose LED light. Easy installation with glue or screws. Can be used in cars, boats and mobile homes. When used at home, a 230 V power supply unit for LEDs can be connected. Measurements 70 x 70 x 6 mm, light color warm-white, 3,200 K, housing plastic with silver coated frame.

	BP	SP
	VKE = 50	VKE = 20
<b>1 W</b>	57403000	57403500



### Mini LED Spot

8-30 V battery current. The ballast is integrated in the lamp base. Can be pivoted and swivelled, high luminance, making it ideal as a reading and spotlight in mobile homes, trucks, boats. When used at home a 230 V power supply unit can be connected. Light color warm-white 2,700 K, housing aluminium-matt.

	BP	SP
	SU = 20	SU = 20
<b>without switch-key, 2.5 W</b>	57421010	57421510
<b>with switch-key, 2.5 W</b>	57421111	57421611
<b>Power LED Spot, 6 W, without switch-key, dimmable</b>	57421200	-
<b>Power LED Spot, 6 W, with switch-key, dimmable</b>	57421220	-

### Surface Mounted / Built-In Power LED

8-30 V battery current / 3 W. All-purpose surface mounted / built-in LED light, with integrated ballast, pleasant warm white light colour, large radiation angle of 160°, extremely slim design, making it ideal for installation in/under cupboards and as an energy-saving light in mobile homes, trucks, boats. When used at home a 230 V power supply unit can be connected. Light color warm-white, housing aluminium-matt.

	BP	SP
	SU = 50	SU = 40
<b>without switch-key</b>	57423000	57423500
<b>with switch-key</b>	57423011	57423511

All dimensions in mm

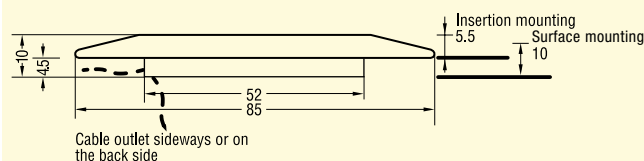

Diameter	85 mm
Height	10 mm
Operating voltage	8-30 V
Current consumption	0.25 A (at 12 V)
Power consumption	3 W
LED Power	2.5 W
Color temperature	2,700 Kelvin
Angle of reflected beam	150°

... future  
LED technology



Ø 70 mm, 9 mm flat



□ 70 mm, 9 mm flat

### Surface Mounted Power LED

8-30 V battery current / 3.6 W. Flat, all-purpose LED light with a large radiation angle of 160°, and an extremely slim design, making it ideal for installation in/under cupboards and as an energy-saving light in mobile homes, trucks, and boats. When used at home a 230 V power supply unit can be connected. Mounting via adhesive pads. Light color warm-white, 2,700 K, housing aluminium-matt.

	BP	SP
	SU = 20	SU = 20
<b>round</b>	57425000	57425500
<b>square</b>	57426000	57426500



### Surface Mounted Power LED Maxi

11-30 V battery current / 6 W. All-purpose surface mounted Power LED light. Its large angle of reflected beam and its high capacity makes it perfect for illuminating rooms. For use in cars, boats, and mobile homes. When used at home a 230 V power supply unit can be connected. Measurements diameter 120 mm, height 10.5 mm. Light color warm-white, housing aluminium-matt.

	BP	SP
	VSU = 20	SU = 20
<b>6 W</b>	57424000	57424500

... saves up to  
80% energy!

Resolve a tyre puncture easier, faster and more effectively and enables you to continue driving within 3 minutes. Upon pressing a button the sealant is pumped in the tyre and the minimum air pressure for continue driving is established.

Instead of conventional latex products, PREMIUM SEAL uses a completely newly developed microfibre substance which can be quickly and easily rinsed out. No more sticky tyres and rims.

- seals punctures up to 5 mm
- water pollution class 1 (biodegradable substance)
- DEKRA tested



Easy and fast application of PS REPA



**Repair Set for Cars and Motorcycles**

for car tyres with an air pressure up to 2.5 bar and a tyre size till 245 mm.

1 can of PS REPA SET 650 ml.

SP  
 SU = 10  
 54002530

**Repair Set for Transporters and Caravans**

for an air pressure up to 4.8 bar and a tyre size till 245 mm.  
 2 can PS REPA SET 650 ml.

SP  
 SU = 10  
 54002540



**Repair Set for Transporters and Caravans**

for an air pressure up to 4.8 bar and a tyre size till 205 mm.  
 1 can PS REPA SET 650 ml and 1 can fuel gas 500 ml.

SP  
 SU = 10  
 54002550

# 25 Years

## INNOVATION EXPERTISE PARTNER

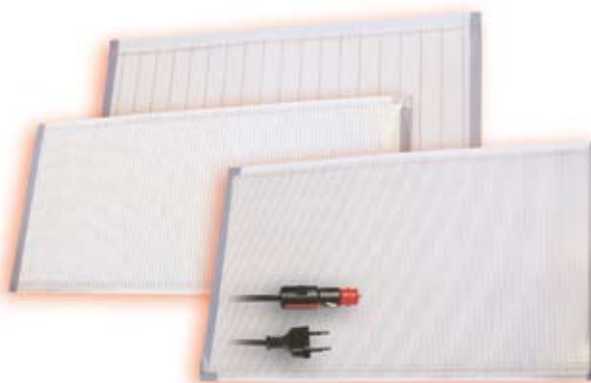

### Heating Fabric, 12 volt, 32 volt and 230 volt

For more than 15 years, heating fabric has been used in the original equipment and retrofitting of underfloor heating in camper vans, caravans, at home and in the workplace (office, workshop or market stall), where it has proven its worth.

The heating fabric, less than 1 mm thick, is flexible and ideally suited for heating surfaces, stone slabs, tiles, mirrors, carpets, laminate and almost all floorings, which are also designed for underfloor heating. The glass fibre fabric consists of heat-conducting carbon fibres, which generate pleasant heat within a few minutes.

Available by the metre or ready to connect, the surface heating system is available in diverse dimensions and in voltages of 12, 32 and 230 volt for industry, trade and trades and craft professions. We also offer appropriate transformers for the low-voltage versions.

The heated fabric is also used in our heating carpets and PVC mats.

### Technical specifications

for standard versions, ready assembled with power cord:

Voltage	Output	Width	Length up to max.
12 volt	approx. 160 watt/m <sup>2</sup>	50 cm	150 cm
32 volt	approx. 160 watt/m <sup>2</sup>	60 cm	400 cm
		80 cm	320 cm
230 volt	approx. 160 watt/m <sup>2</sup>	30, 50, 60, 75 cm	–

### Power cable assembly:

- 12 volt = approx. 2.0 m power cord, with universal plug
- 32 volt = approx. 2.5 m power cord, end open
- 230 volt = approx. 2.5 m power cord, with flat two-pin plug

### Heating Fabric

Voltage	Width	Art. No.
12 volt	50 cm	20105000
32 volt	60 cm	22106000
32 volt	80 cm	22108000
230 volt	30 cm	25103000
230 volt	50 cm	25105000
230 volt	60 cm	25106000
230 volt	75 cm	25107500

Output approx. 160 watt / m<sup>2</sup>.

Please give required length to nearest 10 cm.

Heating fabric incl. power cord assembly.

### Advantages and properties:

- Short heating up time
- Low power consumption
- Low cost purchase and operation (use)
- Flexible and easy to lay (ready to connect)
- Maintenance free
- Silent
- No raised dust





### Heating Carpet, 12 volt and 230 volt

Just put down and enjoy the heat. The new version of these carpets convince by their two-sided design, one side carpet and the other side anti-slip material. The high-quality heating carpets are available in four standard sizes and

6 different colors. After a short starting-up time (approx. 10 min.), a pleasant foot temperature of up to approx. 30 °C develops. Special sizes available on request.

	Size	Art.-No.					
		silver	dark grey	brown	light brown	blue	grew/brown plaid
<b>12 Volt</b>							
ca. 25W	60 x 40 cm	20203500	20203501	20203521	20203520	20203512	20203530
ca. 50W	60 x 70 cm	20206000	20206001	20206021	20206020	20206012	20206030
ca. 70W	60 x 100 cm	20209000	20209001	20209021	20209020	20209012	20209030
<b>230 Volt</b>							
ca. 25W	60 x 40 cm	25203500	25203501	25203521	25203520	25203512	25203530
ca. 50W	60 x 70 cm	25206000	25206001	25206021	25206020	25206012	25206030
ca. 70W	60 x 100 cm	25209000	25209001	25209021	25209020	25209012	25209030
ca. 100W	80 x 90 cm	25201100	25201101	25201121	25201120	25201112	25201130



### Velour Heating Carpet, 12 volt and 230 volt

Just put down and enjoy the heat. The new version of these carpets convince by their two-sided design, one side carpet and the other side anti-slip material. The high-quality heating carpets are available in four standard sizes. After a short starting-up time (approx. 10 min.), a pleasant foot temperature of up to approx. 30 °C develops. Special sizes available on request.

	Size	Art.-No.
<b>12 Volt</b>		<b>light beige</b>
ca. 25 W	60 x 40 cm	20203522
ca. 50 W	60 x 70 cm	20206022
ca. 70 W	60 x 100 cm	20209022
<b>230 Volt</b>		
ca. 25 W	60 x 40 cm	25203522
ca. 50 W	60 x 70 cm	25206022
ca. 70 W	60 x 100 cm	25209022
ca. 100 W	80 x 90 cm	25201122

### Bathroom Heating Carpet 12 volt and 230 volt

Pleasantly warm feet in the bathroom. The upper material consists of a super soft pile and an anti-slip material on the back. The heated bathroom carpets are available in 3 standard sizes and 2 colors. The heating fabric can be removed using a zip, enabling the carpet to be cleaned in the washing machine at up to 60 °C.

	Size	Art.-No.	
<b>12 Volt</b>		<b>blue</b>	<b>white</b>
ca. 30 W	55 x 40 cm	20404012	20404001
ca. 50 W	55 x 65 cm	20407012	20407001
ca. 70 W	55 x 95 cm	20401012	20401001
<b>230 Volt</b>			
ca. 30 W	55 x 40 cm	25404012	25404001
ca. 50 W	55 x 65 cm	25407012	25407001
ca. 70 W	55 x 95 cm	25401012	25401001

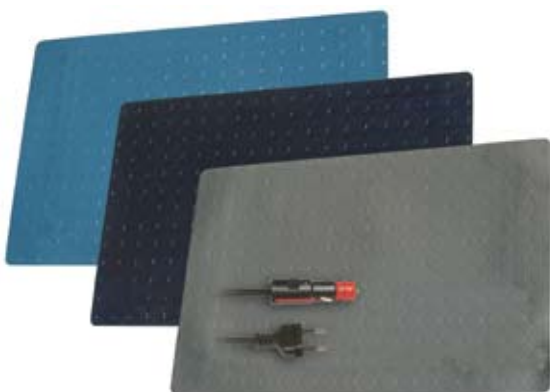

### PVC Heating Mats, 12 volt and 230 volt

The robust PVC heating mats can be used on both sides and are available in 4 standard sizes and 3 colors. After a short starting-up time (approx. 10 min.), a pleasant foot temperature of up to approx. 30° develops. Special sizes available on request.

12 volt	Size	Art.-No.		
	cm	blue	grey	black
approx. 25 W	60 x 40	20213512	20213563	20213560
approx. 50 W	60 x 70	20216012	20216063	20216060
approx. 70 W	60 x 100	20219012	20219063	20219060
<b>230 volt</b>				
approx. 25 W	60 x 40	25213512	25213563	25213560
approx. 50 W	60 x 70	25216012	25216063	25216060
approx. 70 W	60 x 100	25219012	25219063	25219060
approx. 100 W	80 x 90	25211112	25211163	25211160



### Heatable Auto Carpet

12 V for the driver side left or passenger side right, incl. power cord assembly with 1 m cable for connecting to a cigarette lighter and standard socket through the 12 V electric circuit. This auto carpet can be used anywhere; it includes a auto carpet surface and a anti-slip bottom. After a short starting-up time (approx. 10 min.), a pleasant foot temperature of up to approx. 30 °C develops. Dimensions 54 x 40 cm, approx. 22 Watt

	Art.-No.
Driver side, left	20201011
Passenger side, right	20201010



### Heating Auto Carpet 12 V suitable for Fiat Ducato 2014

incl. power cord assembly with 1.2 m cable for connecting to a cigarette lighter and standard socket trough the 12 V electric circuit. The top of the heating carpet is auto carpet and the bottom is anti-slip material. After a short starting-up time (approx. 10 min.), a pleasant foot temperature of up to approx. 30 °C develops.

Output approx. 80 watt, color dark grey

	Art.-No.
Fiat Ducato 2014	20201020



### Heating Auto Carpet 12 V suitable for VW T5

incl. power cord assembly with 1.2 m cable for connecting to a cigarette lighter and standard socket trough the 12 V electric circuit. The top of the heating carpet is auto carpet and the bottom is anti-slip material. After a short starting-up time (approx. 10 min.), a pleasant foot temperature of up to approx. 30 °C develops.

Output approx. 65 watt, color dark grey

	Art.-No.
VW T5	20201021





After a short heating time pleasant heat spreads, especially in the seat and back areas particularly sensitive to cold, hence also protects against health problems. When camping, on the terrace or in the garden, even cooler evenings can be enjoyed for a long, pleasant period.

The heater is run with 12 volt and requires only approx. 60 watt. The heat, around 35 °C, is uniformly distributed by a non-woven with stitched on copper steel conductors, and therefore very robust. It is connected using the universal plug, which fits in 12 volt DIN and cigarette lighter sockets.

With a transformer (available in the accessories), the cushions can also be used with a 230 volt supply.



**Heated Seat Cushion, 12 volt**

The cushion covers are made of approx. 66% cotton and approx. 34% acrylic and are fitted with a zip for easy removal; washable at 30°.

12 volt, 5 A with approx. 2.0 m power cord with universal plug.

Colors blue and grey.

Other colors available on request.

Watt	Size	Art.-No.	
		blue	grey
approx. 60	120 x 50 x 4 cm	20700210	20700264



**EisEx Heating Cable, 12 volt, 24 volt and 48 volt**

Adapts itself to every water pipe bend and quickly thaws out even frozen pipes and outlet valves.

Can be used in all pipes at risk from frost and for special solutions. Ideal for winter camping in caravans and camper vans.

The heating cable is laid or wound around pipes. It can be directly connected to the vehicle's 12 volt electrical system.

Can also be used via 230 volt with a transformer.

Orders must be for twice the length of the pipe to be heated. Special lengths and outputs available on request.

**Lengths longer than 1 m available in 10 cm steps.**

**Output approx. 7.5 watt per metre.**

Volt	Art.-No.
12	20500000
24	21500000
48	23500000





**12 Volt Transformers**

For connecting 12 Volt devices, e.g., electric coolers, lighting, PRO CAR heating cushion, bathroom and heating carpets, and PVC heating mats.

	<b>Art.-No.</b>
230 V/12 V~ 100 VA	20901001
230 V/12 V~ 200 VA	20902001

**Electric socket power supply 60 W**

230 V AC input / 12 V DC 5A output with approx. 1.2 m cable and connector, internal Ø 21 mm.

For connecting 12 Volt devices, e.g., electric coolers, lighting, PRO CAR heating cushion, bathroom and heating carpets, and PVC heating mats.

	<b>IV</b>	<b>EV</b>
	VKE = 50	VKE = 20
	20900700	20900750

... accessories for  
bathroom and heating carpets,  
as well  
as other consumer.



**Euro Flat Plug**

with integrated black ON/OFF rocker switch, 23 cm cable and Euro socket connector.

For operating PRO CAR heating carpets and other 230 Volt devices.

	<b>IV</b>	<b>EV</b>
	VKE = 100	VKE = 60
	20901010	20901011