



ProLight PQ2A-4FxE-xxFC
4W Power LED
Technical Datasheet
Version: 2.0

ProLight Opto © PQ2A Series

Features

- Best Moisture Sensitivity:JEDEC Level 1
- RoHS compliant
- Very wide Viewing Angle

Main Applications

- Entertainment Lighting
- Commercial Lighting
- Indoor Lighting
- Outdoor Lighting
- Stage Lighting
- Consumer Portable
- Architectural
- High-End Portable

Introduction

- ProLight 1616, is one of the smallest high power LED footprint available by ProLight Opto, has offered extended solid-state lighting design possibilities. The 1616's combination of consistent design across all configurations and its small size permit improved color mixing and optical control, compared to the larger 3535 LED. ProLight 1616 is designed with ProLight unique packaging technology which providing high stability reliability.
- 1616 qualifies as the JEDEC Level 1 MSL sensitivity level and suitable for SMD process, Pb free reflow soldering capability, and full compliance with EU education of Hazardous Substances (RoHS) legislation.

Emitter Mechanical Dimensions

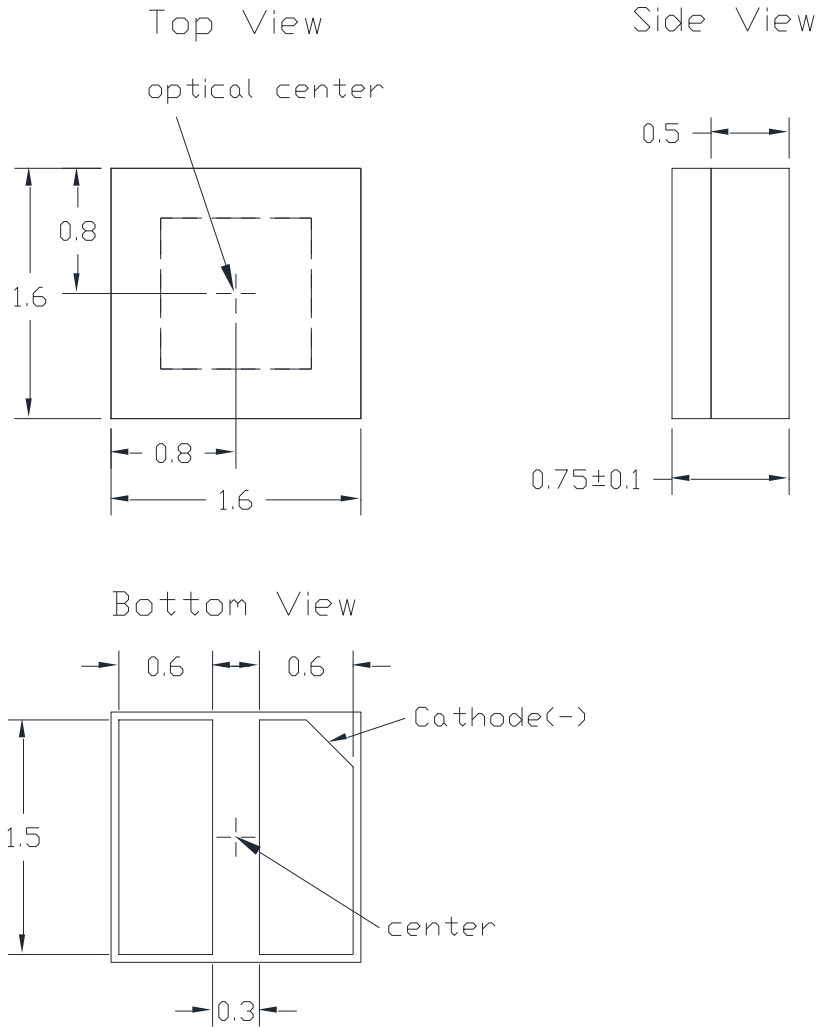

Notes:

1. Drawing not to scale.
2. All dimensions are in millimeters.
3. Unless otherwise indicated, tolerances are ± 0.10 mm.
4. Please do not solder the emitter by manual hand soldering, otherwise it will damage the emitter.
5. **Please do not use a force of over 0.3kgf impact or pressure on the lens of the LED, otherwise it will cause a catastrophic failure.**

Flux Characteristics, $T_j = 25^\circ\text{C}$

Color	Part Number Emitter	Luminous Flux Φ_v (lm)					
		@350mA		Refer @700mA		Refer @1000mA	
		Min.	Typ.	Min.	Typ.	Min.	Typ.
White	PQ2A-4FWE-FC	110	125	200	228	248	281
Neutral White	PQ2A-4FNE-FC	110	120	200	219	248	270
Warm White	PQ2A-4FVE-FCR8	90	100	164	182	203	225
PC Amber	PQ2A-4FPE-AFC	70	80	126	144	156	180
PC Yellow Green	PQ2A-4FPE-YGFC	110	128	200	233	248	288

- ProLight maintains a tolerance of $\pm 7\%$ on flux and power measurements.
- Please do not drive at rated current more than 1 second without proper heat sink.

Electrical Characteristics, $T_j = 25^\circ\text{C}$

Color	Forward Voltage V_F (V)					Thermal Resistance Junction to Slug ($^\circ\text{C}/\text{W}$)
	Min.	@350mA		Refer	Refer	
		Typ.	Max.	@700mA Typ.	@1000mA Typ.	
White	2.8	3.0	3.4	3.2	3.3	6
Neutral White	2.8	3.0	3.4	3.2	3.3	6
Warm White	2.8	3.0	3.4	3.2	3.3	6
PC Amber	2.8	3.0	3.4	3.2	3.3	6
PC Yellow Green	2.8	3.0	3.4	3.2	3.3	6

- ProLight maintains a tolerance of $\pm 0.1\text{V}$ for Voltage measurements.

Optical Characteristics at 350mA, $T_j = 25^\circ\text{C}$

Radiation Pattern	Color	Dominant Wavelength λ_D or Color Temperature CCT			Total included Angle (degrees)	Viewing Angle (degrees)
		Min.	Typ.	Max.	$\theta_{0.90V}$	$2\theta_{1/2}$
			White	4800 K	5600 K	6450 K
	Neutral White	4200 K	4500 K	4800 K	160	130
Lambertian	Warm White	2580 K	2900 K	3250 K	160	130
	PC Amber	587.5 nm	589.7 nm	592.5 nm	160	130
	PC Yellow Green	566.0 nm	567.5 nm	569.0 nm	160	130

- ProLight maintains a tolerance of $\pm 1\text{nm}$ for dominant wavelength measurements.
- ProLight maintains a tolerance of $\pm 5\%$ for CCT measurements.

Absolute Maximum Ratings

Parameter	White/Neutral White/ Warm White/PC Amber/PC Yellow Green
DC Forward Current (mA)	1000
Peak Pulsed Forward Current (mA)	1500 (less than 1/10 duty cycle@1KHz)
ESD Sensitivity (HBM per MIL-STD-883E Method 3015.7)	2KV
LED Junction Temperature	125°C
Operating Board Temperature at Maximum DC Forward Current	-40°C - 105°C
Storage Temperature	-40°C - 120°C
Soldering Temperature	JEDEC 020c 260°C
Allowable Reflow Cycles	3
Reverse Voltage	Not designed to be driven in reverse bias

Photometric Luminous Flux Bin Structure at 350mA

Color	Bin Code	Minimum Photometric Flux (lm)	Maximum Photometric Flux (lm)	Available Color Bins
White	V1	110	120	All W2, W3, X1, X4 ^[1]
	V2	120	130	
	W1	130	140	
Neutral White	V1	110	120	All [1]
	V2	120	130	
Warm White	U1	90	100	All [1]
	U2	100	110	
PC Amber	T1	70	80	3 2 [1]
	T2	80	90	
	U1	90	100	
PC Yellow Green	V1	110	120	All All [1]
	V2	120	130	
	W1	130	140	

- ProLight maintains a tolerance of $\pm 7\%$ on flux and power measurements.
- The flux bin of the product may be modified for improvement without notice.
- ^[1] The rest of color bins are not 100% ready for order currently. Please ask for quote and order possibility.

Color Bin

White Binning Structure Graphical Representation

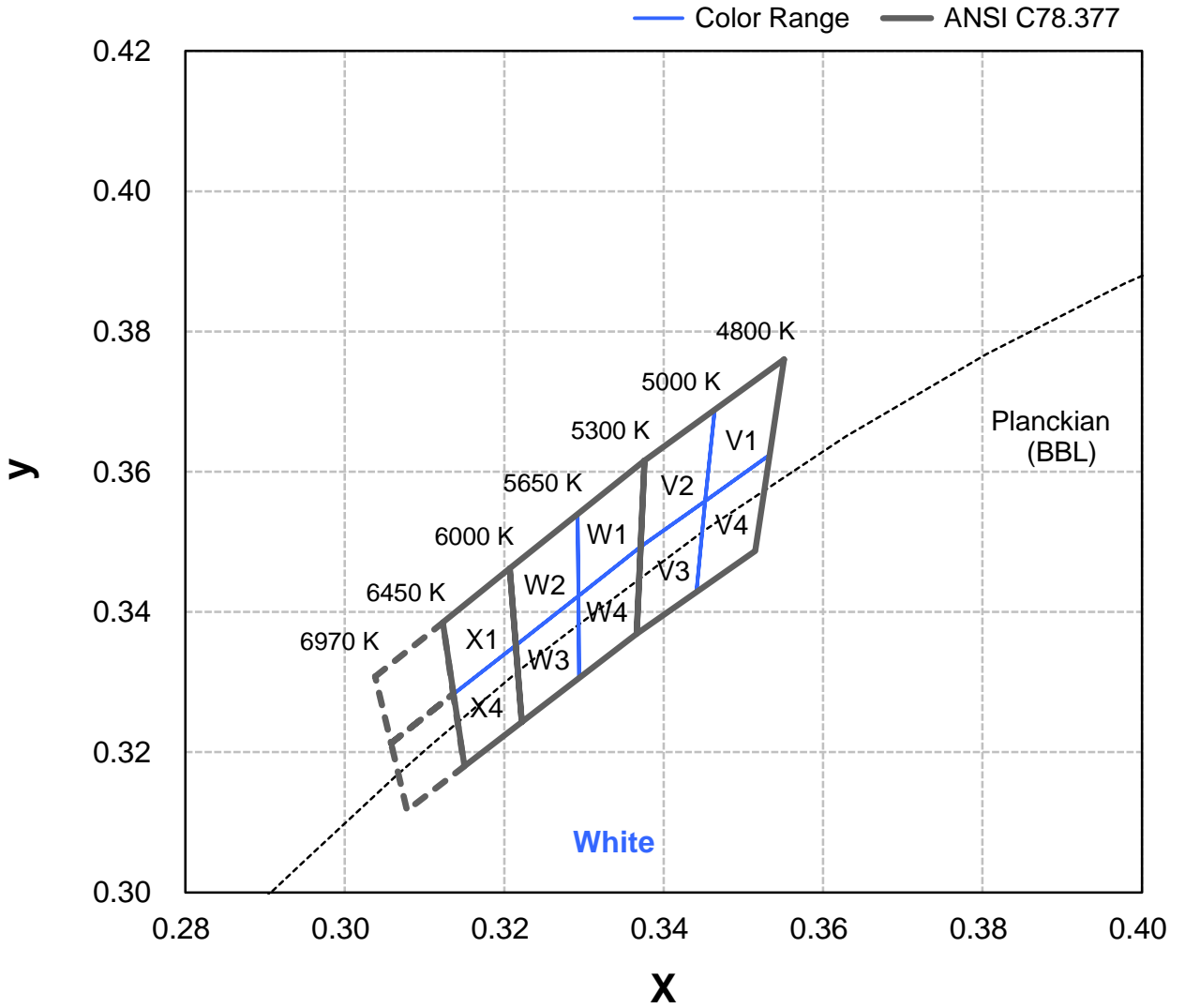

Color Bin

White Bin Structure

Bin Code	x	y	Typ. CCT (K)	Bin Code	x	y	Typ. CCT (K)
V1	0.3464	0.3688	4870	W4	0.3293	0.3423	5475
	0.3551	0.3760			0.3371	0.3493	
	0.3533	0.3624			0.3366	0.3369	
	0.3452	0.3558			0.3294	0.3306	
V4	0.3452	0.3558	4870	W2	0.3207	0.3462	5830
	0.3533	0.3624			0.3292	0.3539	
	0.3515	0.3487			0.3293	0.3423	
	0.3441	0.3428			0.3215	0.3353	
V2	0.3376	0.3616	5155	W3	0.3215	0.3353	5830
	0.3464	0.3688			0.3293	0.3423	
	0.3452	0.3558			0.3294	0.3306	
	0.3371	0.3493			0.3222	0.3243	
V3	0.3371	0.3493	5155	X1	0.3123	0.3385	6240
	0.3452	0.3558			0.3207	0.3462	
	0.3441	0.3428			0.3215	0.3353	
	0.3366	0.3369			0.3136	0.3283	
W1	0.3292	0.3539	5475	X4	0.3136	0.3283	6240
	0.3376	0.3616			0.3215	0.3353	
	0.3371	0.3493			0.3222	0.3243	
	0.3293	0.3423			0.3150	0.3180	

- Tolerance on each color bin (x , y) is ± 0.005

Color Bin

Neutral White Binning Structure Graphical Representation

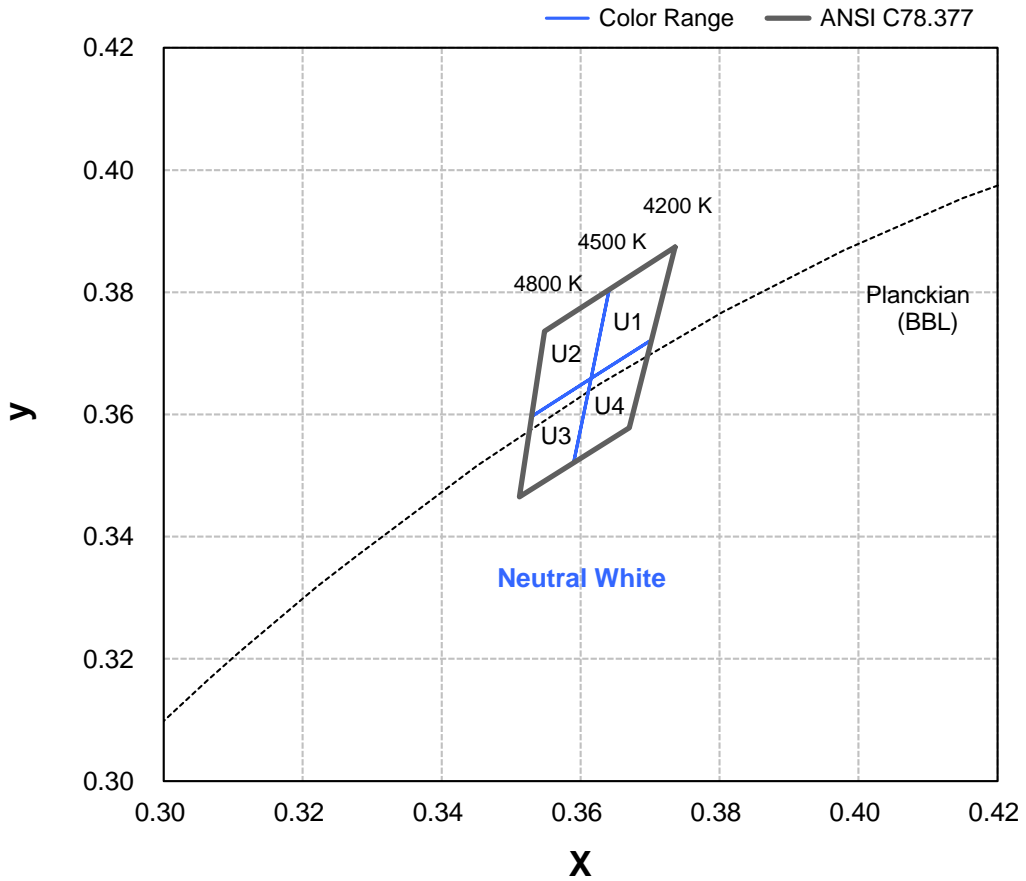

Neutral White Bin Structure

Bin Code	x	y	Typ. CCT (K)	Bin Code	x	y	Typ. CCT (K)
U1	0.3641	0.3804	4350	U2	0.3548	0.3736	4650
	0.3736	0.3874			0.3641	0.3804	
	0.3702	0.3722			0.3615	0.3659	
U4	0.3615	0.3659	4350	U3	0.353	0.3597	4650
	0.3615	0.3659			0.3530	0.3597	
	0.3702	0.3722			0.3615	0.3659	
	0.3670	0.3578			0.3590	0.3521	
	0.3590	0.3521			0.3512	0.3465	

- Tolerance on each color bin (x , y) is ± 0.005

Color Bin

Warm White Binning Structure Graphical Representation

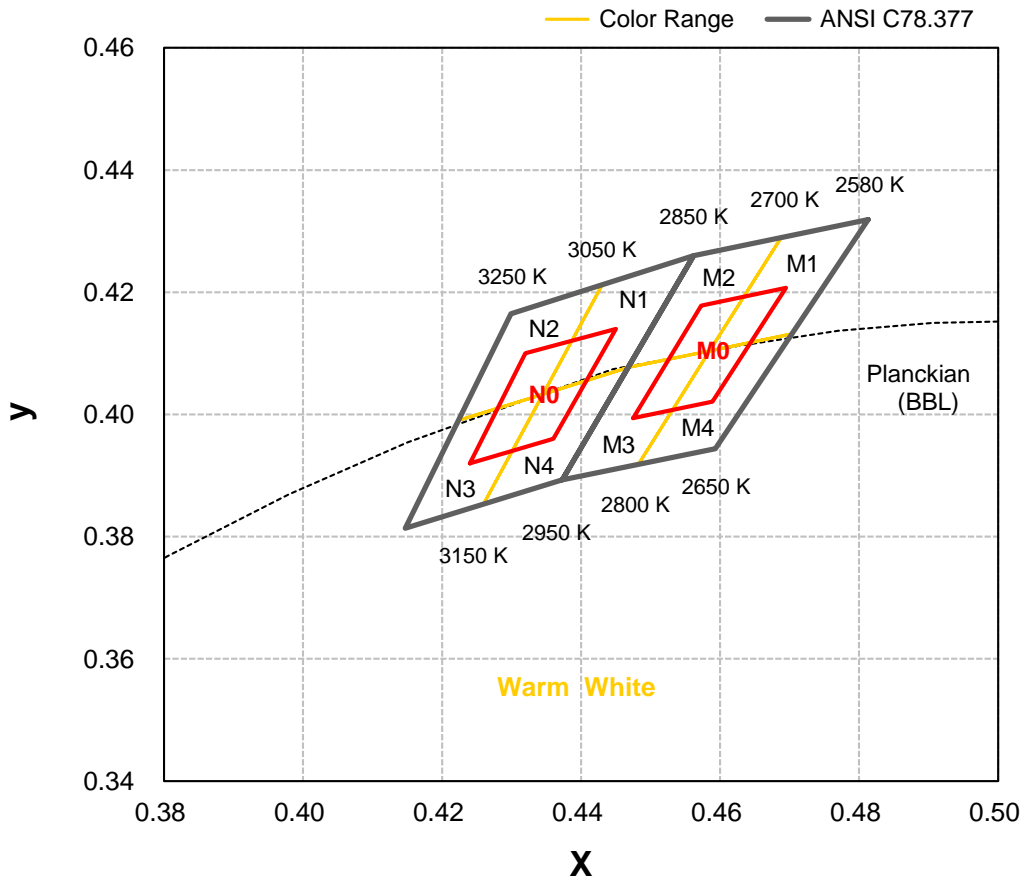

Color Bin

Warm White Bin Structure

Bin Code	x	y	Typ. CCT (K)	Bin Code	x	y	Typ. CCT (K)
M1	0.481	0.432	2650	N1	0.443	0.421	2950
	0.469	0.429			0.456	0.426	
	0.459	0.410			0.447	0.408	
	0.470	0.413			0.435	0.403	
M4	0.470	0.413	2650	N4	0.435	0.403	2950
	0.459	0.410			0.447	0.408	
	0.448	0.392			0.437	0.389	
	0.459	0.394			0.426	0.385	
M0	0.448	0.399	2700	N0	0.424	0.392	3050
	0.457	0.418			0.432	0.410	
	0.470	0.421			0.445	0.414	
	0.459	0.402			0.436	0.396	
M2	0.469	0.429	2800	N2	0.430	0.417	3150
	0.456	0.426			0.443	0.421	
	0.447	0.408			0.435	0.403	
	0.459	0.410			0.422	0.399	
M3	0.459	0.410	2800	N3	0.422	0.399	3150
	0.447	0.408			0.435	0.403	
	0.437	0.389			0.426	0.385	
	0.448	0.392			0.415	0.381	

- Tolerance on each color bin (x , y) is ± 0.005

Note:

1. Although several bins are outlined, product availability in a particular bin varies by production run and by product performance. Not all bins are available in all colors.
2. ProLight **SmartBin** is working to make the color bin smarter, by selecting that intelligence is infused into major **M0 , N0** bin with minor M1-M4 , N1-N4 bins and processes that make assembly easily

Color Bins

PC Amber Binning Structure Graphical Representation

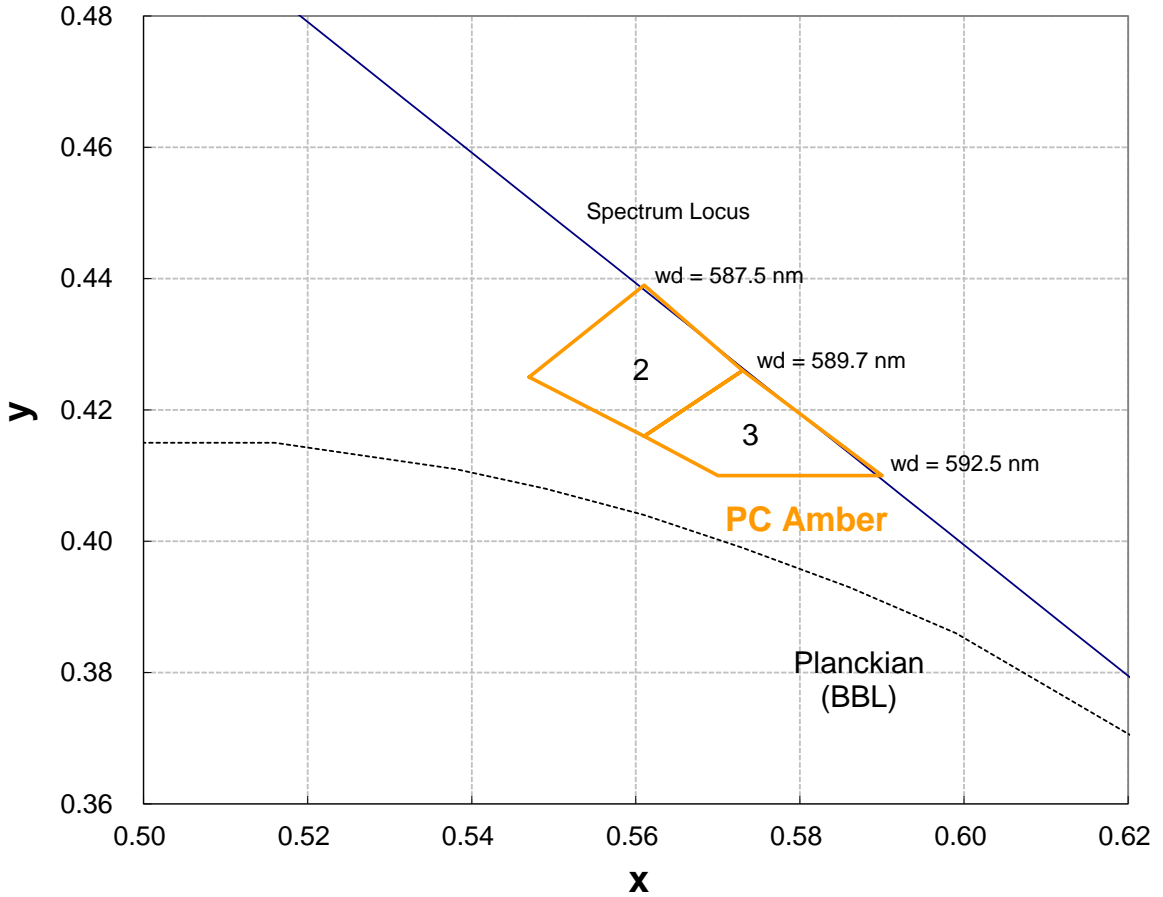

PC Amber Bin Structure

Bin Code	x	y	Bin Code	x	y
2	0.5470	0.4250	3	0.5610	0.4160
	0.5610	0.4160		0.5730	0.4260
	0.5730	0.4260		0.5900	0.4100
	0.5610	0.4390		0.5700	0.4100

- Tolerance on each color bin (x , y) is ± 0.005

Color Bin

PC Yellow Green Binning Structure Graphical Representation

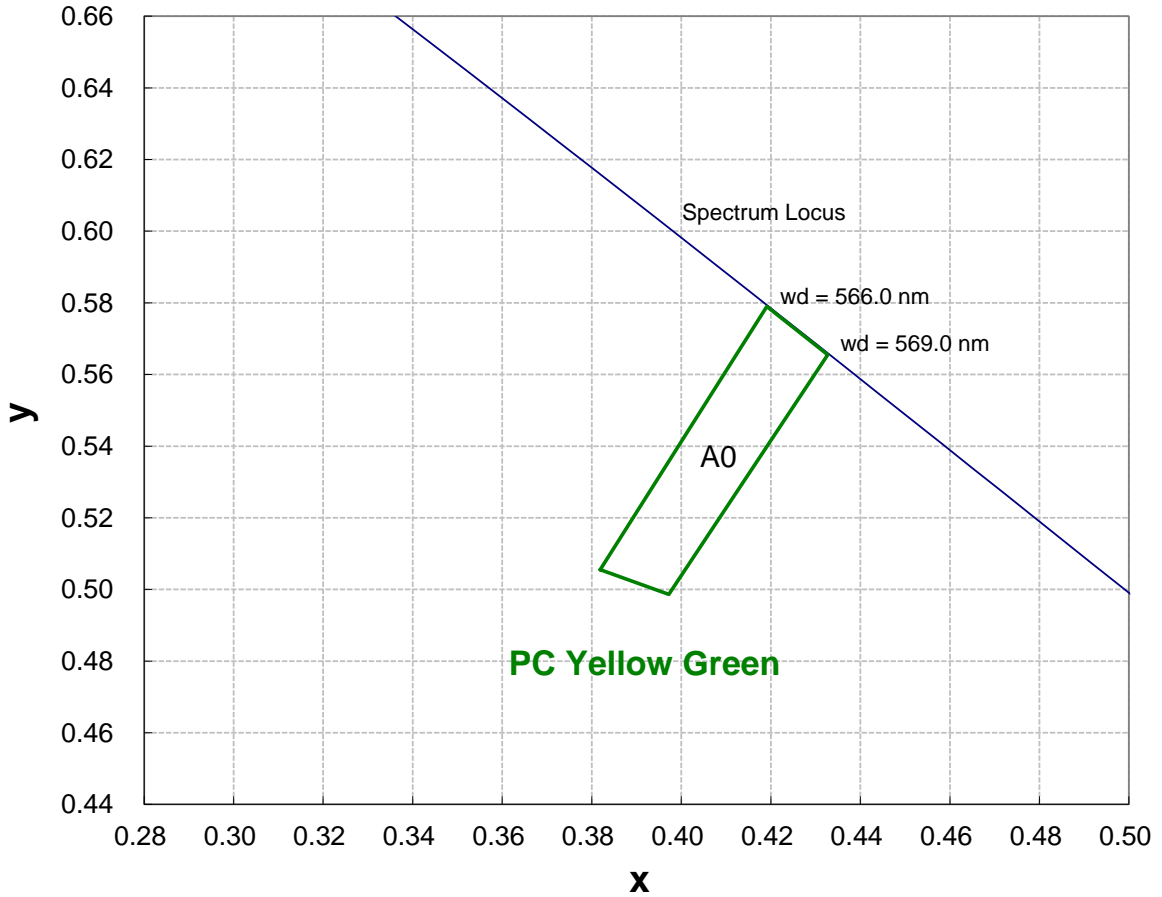

PC Yellow Green Bin Structure

Bin Code	x	y
A0	0.3819	0.5055
	0.4191	0.5790
	0.4327	0.5655
	0.3972	0.4986

- Tolerance on each color bin (x , y) is ± 0.005

Forward Voltage Bin Structure at 350mA

Color	Bin Code	Minimum Voltage (V)	Maximum Voltage (V)
White	A	2.8	3.0
	B	3.0	3.2
	D	3.2	3.4
Neutral White	A	2.8	3.0
	B	3.0	3.2
	D	3.2	3.4
Warm White	A	2.8	3.0
	B	3.0	3.2
	D	3.2	3.4
PC Amber	A	2.8	3.0
	B	3.0	3.2
	D	3.2	3.4
PC Yellow Green	A	2.8	3.0
	B	3.0	3.2
	D	3.2	3.4

- ProLight maintains a tolerance of $\pm 0.1V$ for Voltage measurements.

Note: Although several bins are outlined, product availability in a particular bin varies by production run and by product performance. Not all bins are available in all colors.

Color Spectrum, $T_j = 25^\circ\text{C}$

1. White

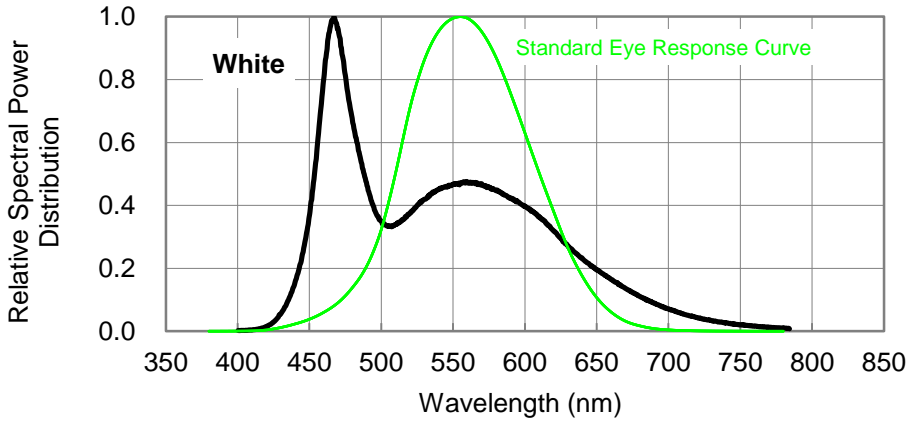

2. Neutral White

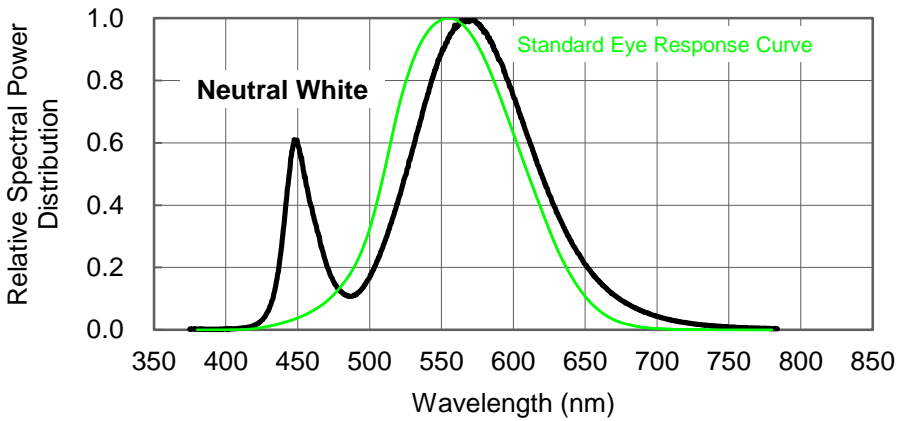

3. Warm White

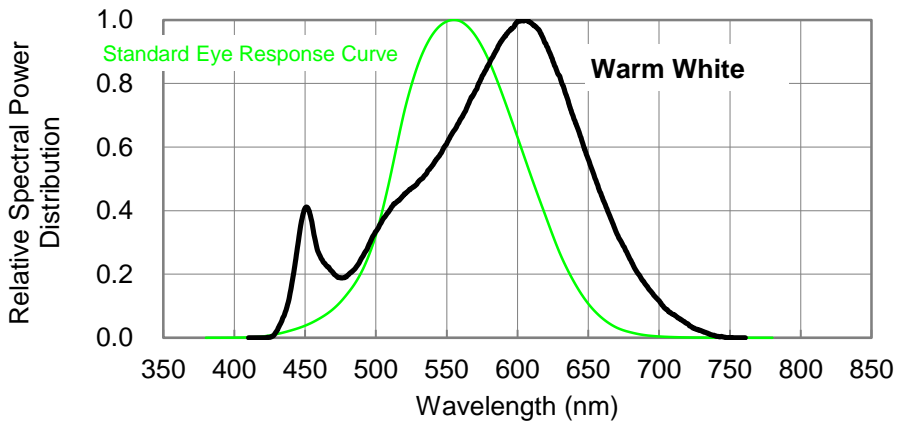

Color Spectrum, $T_j = 25^\circ\text{C}$

4. PC Amber

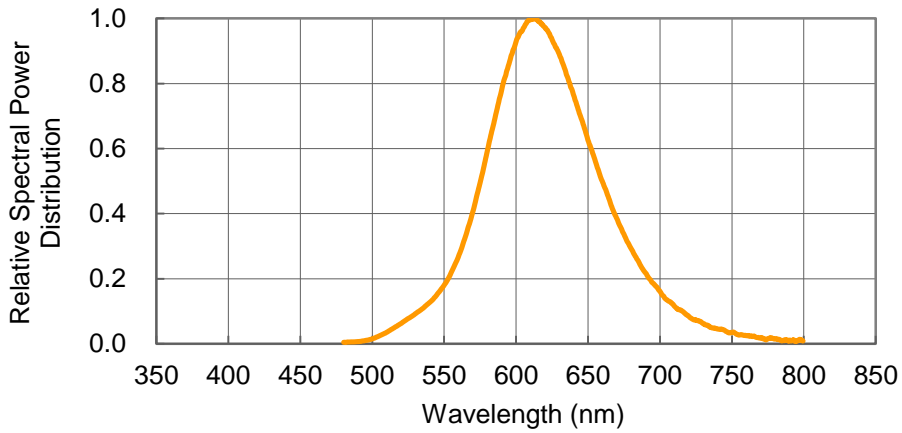

5. PC Yellow Green

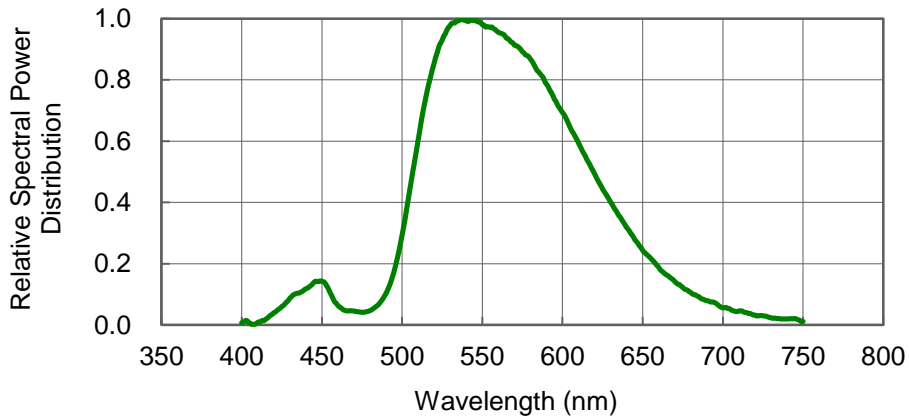

Light Output Characteristics

Relative Light Output vs. Junction Temperature at 350mA

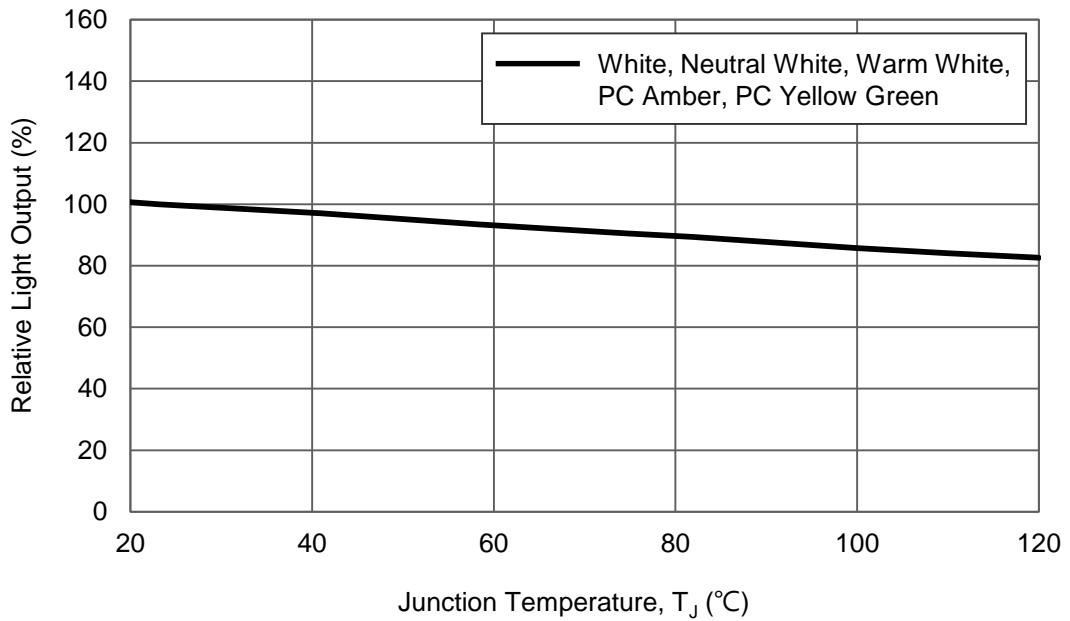

Forward Current Characteristics, $T_J = 25^\circ\text{C}$

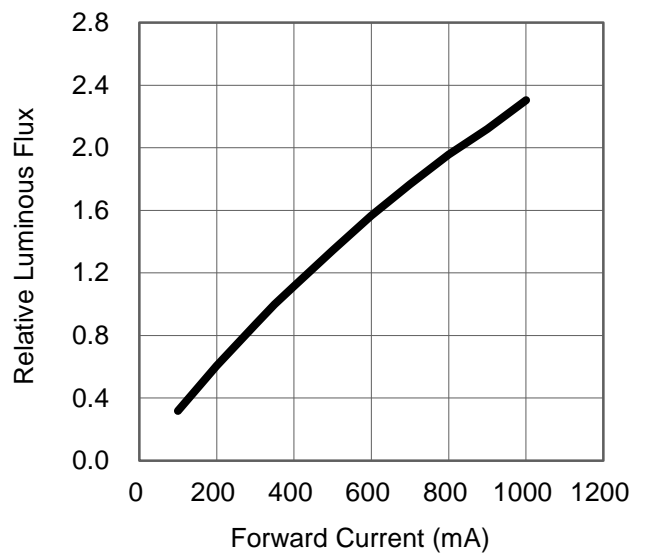
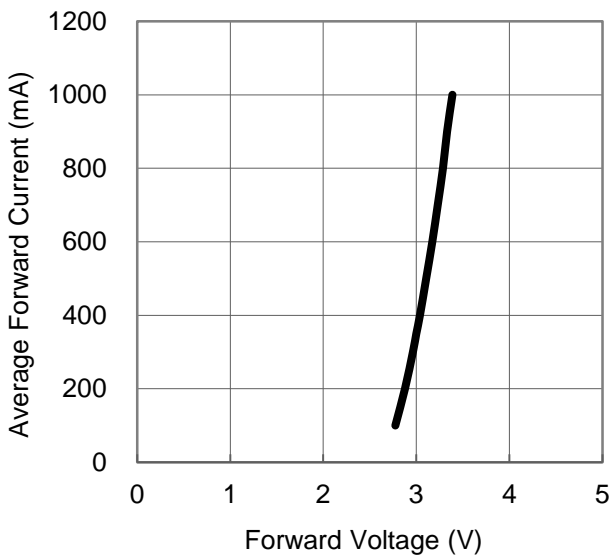

Typical Representative Spatial Radiation Pattern

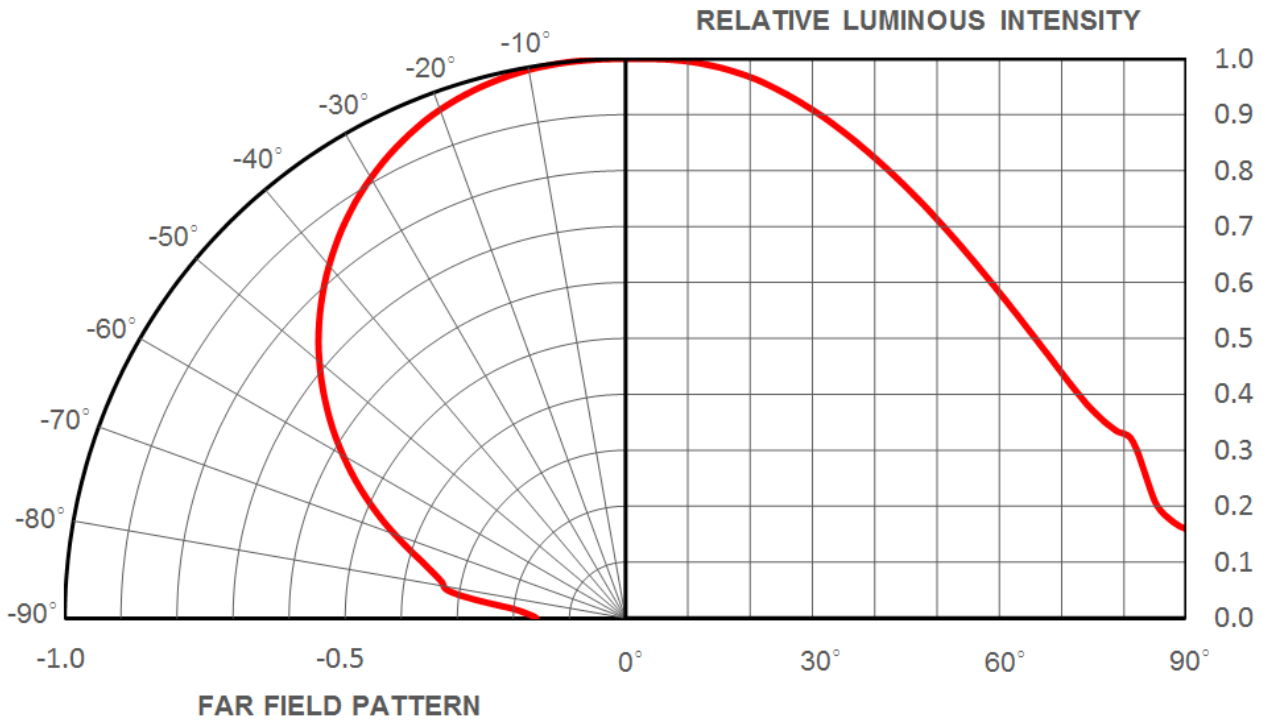

Moisture Sensitivity Level - JEDEC Level 1

Level	Floor Life		Soak Requirements			
			Standard		Accelerated Environment	
	Time	Conditions	Time (hours)	Conditions	Time (hours)	Conditions
1	Unlimited	≤30°C / 85% RH	168 +5/-0	85°C / 85% RH	NA	NA

- The standard soak time includes a default value of 24 hours for semiconductor manufacture's exposure time (MET) between bake and bag and includes the maximum time allowed out of the bag at the distributor's facility.
- Table below presents the moisture sensitivity level definitions per IPC/JEDEC's J-STD-020C.

Level	Floor Life		Soak Requirements			
			Standard		Accelerated Environment	
	Time	Conditions	Time (hours)	Conditions	Time (hours)	Conditions
1	Unlimited	≤30°C / 85% RH	168 +5/-0	85°C / 85% RH	NA	NA
2	1 year	≤30°C / 60% RH	168 +5/-0	85°C / 60% RH	NA	NA
2a	4 weeks	≤30°C / 60% RH	696 +5/-0	30°C / 60% RH	120 +1/-0	60°C / 60% RH
3	168 hours	≤30°C / 60% RH	192 +5/-0	30°C / 60% RH	40 +1/-0	60°C / 60% RH
4	72 hours	≤30°C / 60% RH	96 +2/-0	30°C / 60% RH	20 +0.5/-0	60°C / 60% RH
5	48 hours	≤30°C / 60% RH	72 +2/-0	30°C / 60% RH	15 +0.5/-0	60°C / 60% RH
5a	24 hours	≤30°C / 60% RH	48 +2/-0	30°C / 60% RH	10 +0.5/-0	60°C / 60% RH
6	Time on Label (TOL)	≤30°C / 60% RH	Time on Label (TOL)	30°C / 60% RH	NA	NA

Qualification Reliability Testing

Stress Test	Stress Conditions	Stress Duration	Failure Criteria
Room Temperature Operating Life (RTOL)	25°C, $I_F = \text{max DC}$ (Note 1)	1000 hours	Note 2
Wet High Temperature Operating Life (WHTOL)	85°C/60%RH, $I_F = \text{max DC}$ (Note 1)	1000 hours	Note 2
Wet High Temperature Storage Life (WHTSL)	85°C/85%RH, non-operating	1000 hours	Note 2
High Temperature Storage Life (HTSL)	110°C, non-operating	1000 hours	Note 2
Low Temperature Storage Life (LTSL)	-40°C, non-operating	1000 hours	Note 2
Non-operating Temperature Cycle (TMCL)	-40°C to 120°C, 30 min. dwell, <5 min. transfer	200 cycles	Note 2
Mechanical Shock	1500 G, 0.5 msec. pulse, 5 shocks each 6 axis		Note 3
Natural Drop	On concrete from 1.2 m, 3X		Note 3
Variable Vibration Frequency	10-2000-10 Hz, log or linear sweep rate, 20 G about 1 min., 1.5 mm, 3X/axis		Note 3
Solder Heat Resistance (SHR)	260°C ± 5°C, 10 sec.		Note 3
Solderability	Steam age for 16 hrs., then solder dip at 260°C for 5 sec.		Solder coverage on lead

Notes:

1. Depending on the maximum derating curve.
2. Criteria for judging failure

Item	Test Condition	Criteria for Judgement	
		Min.	Max.
Forward Voltage (V_F)	$I_F = \text{max DC}$	--	Initial Level x 1.1
Luminous Flux or Radiometric Power (Φ_V)	$I_F = \text{max DC}$	Initial Level x 0.7	--
Reverse Current (I_R)	$V_R = 5V$	--	50 μA

* The test is performed after the LED is cooled down to the room temperature.

3. A failure is an LED that is open or shorted.

Recommended Solder Pad Design

Standard Emitter

TYPE A.

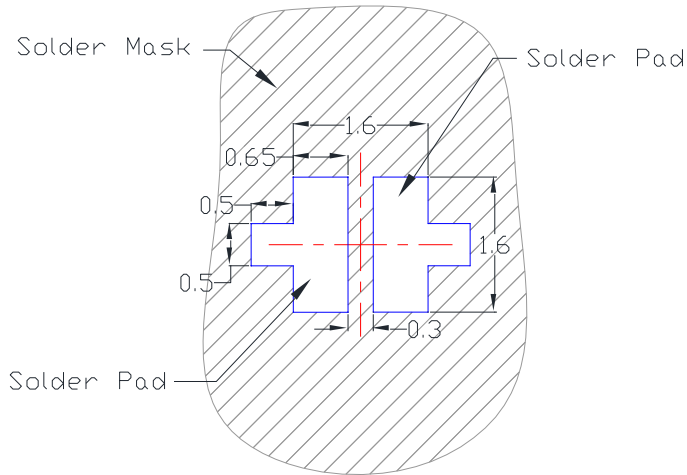

TYPE B.

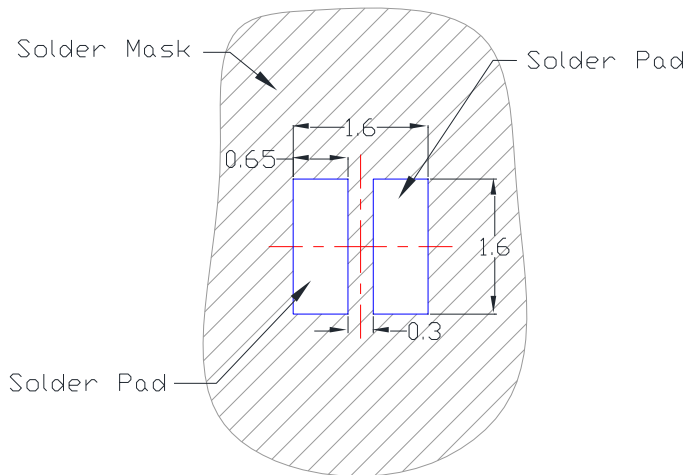

- All dimensions are in millimeters.

Reflow Soldering Condition

Profile Feature	Sn-Pb Eutectic Assembly	Pb-Free Assembly
Average Ramp-Up Rate (T_{Smax} to T_p)	3°C / second max.	3°C / second max.
Preheat <ul style="list-style-type: none"> – Temperature Min (T_{Smin}) – Temperature Max (T_{Smax}) – Time (t_{Smin} to t_{Smax}) 	100°C 150°C 60-120 seconds	150°C 200°C 60-180 seconds
Time maintained above: <ul style="list-style-type: none"> – Temperature (T_L) – Time (t_L) 	183°C 60-150 seconds	217°C 60-150 seconds
Peak/Classification Temperature (T_p)	240°C	260°C
Time Within 5°C of Actual Peak Temperature (t_p)	10-30 seconds	20-40 seconds
Ramp-Down Rate	6°C/second max.	6°C/second max.
Time 25°C to Peak Temperature	6 minutes max.	8 minutes max.

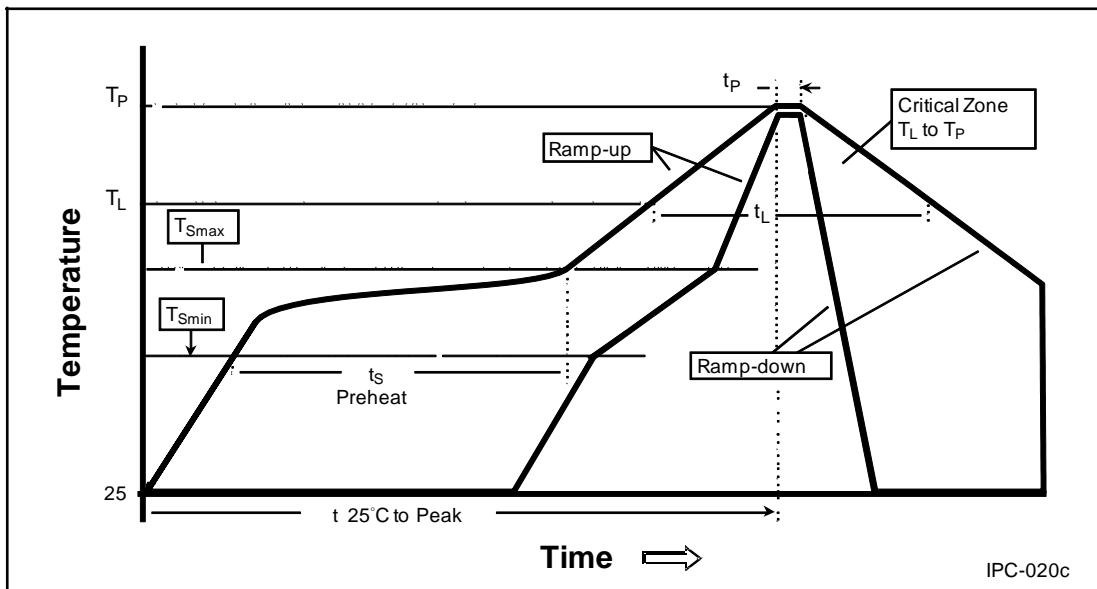

- We recommend using the M705-S101-S4 solder paste from SMIC (Senju Metal Industry Co., Ltd.) for lead-free soldering.
- Do not use solder pastes with post reflow flux residue > 47%. (58Bi-42Sn eutectic alloy, etc) This kind of solder pastes may cause a reliability problem to LED.
- All temperatures refer to topside of the package, measured on the package body surface.
- Repairing should not be done after the LEDs have been soldered. When repairing is unavoidable, a double-head soldering iron should be used. It should be confirmed beforehand whether the characteristics of the LEDs will or will not be damaged by repairing.
- Reflow soldering should not be done more than three times.
- When soldering, do not put stress on the LEDs during heating.
- After soldering, do not warp the circuit board.

Emitter Reel Packaging

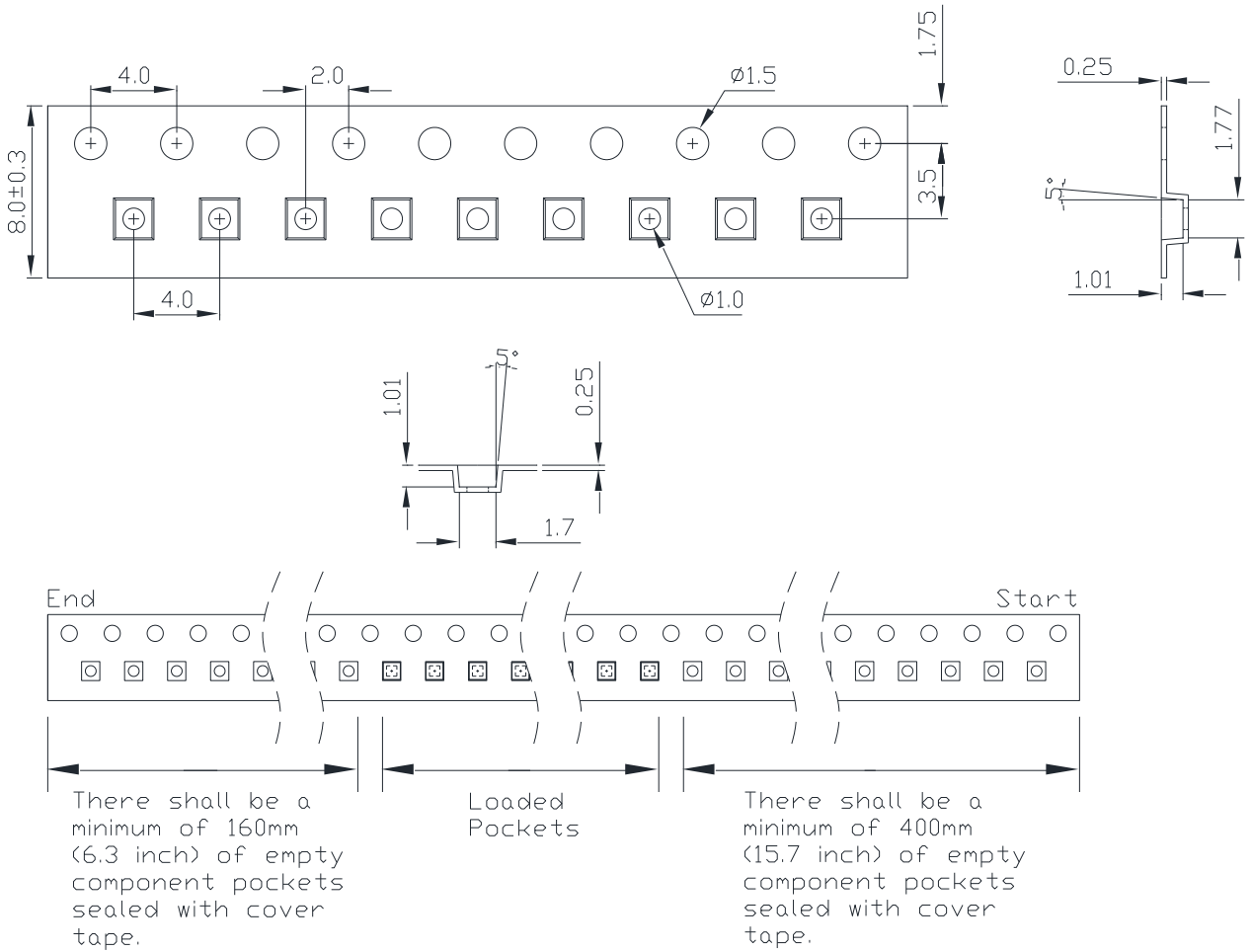

Notes:

1. Drawing not to scale.
2. All dimensions are in millimeters.
3. Unless otherwise indicated, tolerances are ± 0.10 mm.

Emitter Reel Packaging

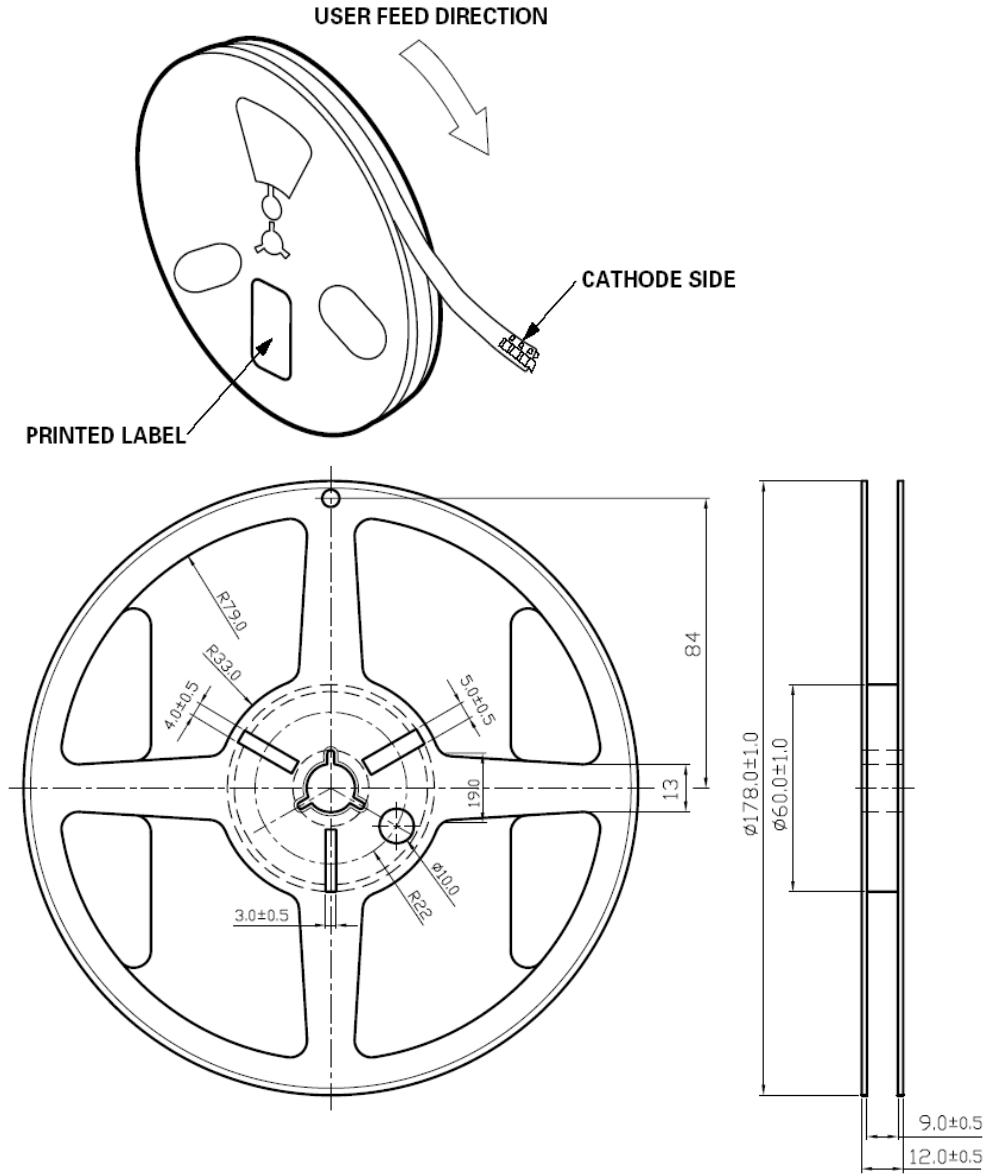

Notes:

1. Empty component pockets sealed with top cover tape.
2. 1000 and 2000 pieces per reel.
3. Drawing not to scale.
4. All dimensions are in millimeters.

Precaution for Use

- Storage
Please do not open the moisture barrier bag (MBB) more than one week. This may cause the leads of LED discoloration. We recommend storing ProLight's LEDs in a dry box after opening the MBB. The recommended storage conditions are temperature 5 to 30 °C and humidity less than 40% RH. It is also recommended to return the LEDs to the MBB and to reseal the MBB.
- The slug is is not electrically neutral. Therefore, we recommend to isolate the heat sink.
- **We recommend using the M705-S101-S4 solder paste from SMIC (Senju Metal Industry Co., Ltd.) for lead-free soldering.**
- **Do not use solder pastes with post reflow flux residue>47%. (58Bi-42Sn eutectic alloy, etc) This kind of solder pastes may cause a reliability problem to LED.**
- Any mechanical force or any excess vibration shall not be accepted to apply during cooling process to normal temperature after soldering.
- Please avoid rapid cooling after soldering.
- Components should not be mounted on warped direction of PCB.
- Repairing should not be done after the LEDs have been soldered. When repairing is unavoidable, a heat plate should be used. It should be confirmed beforehand whether the characteristics of the LEDs will or will not be damaged by repairing.
- This device should not be used in any type of fluid such as water, oil, organic solvent and etc. When cleaning is required, isopropyl alcohol should be used.
- When the LEDs are illuminating, operating current should be decide after considering the package maximum temperature.
- The appearance, specifications and flux bin of the product may be modified for improvement without notice. Please refer to the below website for the latest datasheets.
<http://www.prolightopto.com/>

Handling of Silicone Lens LEDs

Notes for handling of silicone lens LEDs

- Please do not use a force of over 0.3kgf impact or pressure on the silicone lens, otherwise it will cause a catastrophic failure.
- The LEDs should only be picked up by making contact with the sides of the LED body.
- Avoid touching the silicone lens especially by sharp tools such as Tweezers.
- Avoid leaving fingerprints on the silicone lens.
- Please store the LEDs away from dusty areas or seal the product against dust.
- When populating boards in SMT production, there are basically no restrictions regarding the form of the pick and place nozzle, except that mechanical pressure on the silicone lens must be prevented.
- Please do not mold over the silicone lens with another resin. (epoxy, urethane, etc)

