



## SPECIFICATIONS

CUSTOMER	:	_____
SAMPLE CODE	:	SH800480T033-ICB01
MASS PRODUCTION CODE	:	PH800480T033-ICB01
SAMPLE VERSION	:	01
SPECIFICATIONS EDITION	:	002
DRAWING NO. (Ver.)	:	LMD-PH800480T033-ICB01(Ver.001)
PACKAGING NO. (Ver.)	:	PKG-PH800480T033-ICB01(Ver.001)

**Customer Approved**

Date:

Approved	Checked	Designer
廖志豪 Rex Liao	張慶源 Yuan Chang	陳宗淇 Howard Chen

- Preliminary specification for design input
- Specification for sample approval

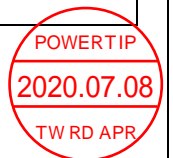

### POWERTIP TECH. CORP.

<b>Headquarters:</b> No.8, 6 <sup>th</sup> Road, Taichung Industrial Park, Taichung, Taiwan 台中市 407 工業區六路 8 號	TEL: 886-4-2355-8168 FAX: 886-4-2355-8166	E-mail: <a href="mailto:sales@powertip.com.tw">sales@powertip.com.tw</a> Http://www.powertip.com.tw
---	--	--



## Contents

### 1. SPECIFICATIONS

- 1.1 Features
- 1.2 Mechanical Specifications
- 1.3 Absolute Maximum Ratings
- 1.4 DC Electrical Characteristics
- 1.5 Optical Characteristics
- 1.6 Backlight Characteristics
- 1.7 Touch Panel Specification

### 2. MODULE STRUCTURE

- 2.1 Counter Drawing
- 2.2 Interface Pin Description
- 2.3 Timing Characteristics

### 3. QUALITY ASSURANCE SYSTEM

- 3.1 Quality Assurance Flow Chart
- 3.2 Inspection Specification

### 4. RELIABILITY TEST

- 4.1 Reliability Test Condition

### 5. PRECAUTION RELATING PRODUCT HANDLING

- 5.1 Safety
- 5.2 Handling
- 5.3 Storage
- 5.4 Terms of Warranty

Appendix : 1.LCM Drawing

2. Packing Specification

Note : For detailed information please refer to IC data sheet :

Primacy(TFT LCD):

ILITEK-- ILI6122 / ILI5960(Or compatible IC )

## 1. SPECIFICATIONS

### 1.1 Features

Item	Standard Value
Display Type	800 * 3 (RGB) * 480 Dots
LCD Type	a-Si TFT , Normally white, Transmissive type
Screen size(inch)	5.0 inch
Viewing Direction	6 O'clock ( Gray scale Inversion )*1
	12 O'clock (*2)
Color configuration	RGB-Strip
Backlight Type	LED B/L
Interface	Digital 24-bits RGB
Other(controller/driver IC)	Source IC : ILI6122 / Gate IC: ILI5960 (Or Compatible IC )
ROHS	THIS PRODUCT CONFORMS THE ROHS OF PTC Detail information please refer website : <a href="http://www.powertip.com.tw/news_detail.php?Key=1&amp;cID=1">http://www.powertip.com.tw/news_detail.php?Key=1&amp;cID=1</a>

Note:

- \*1. For saturated color display content (eg. pure-red, pure-green, pure-blue or pure-colors-combinations).
- \*2. "For display content based upon multicolor images eg. photos, RGB defined user interfaces"

## 1.2 Mechanical Specifications

Item	Standard Value	Unit
Outline Dimension	121.0(W) x 75.9 (L) x 4.2(H)	mm

### LCD panel

Item	Standard Value	Unit
Viewing Area	109.0 (W) * 65.8 (L)	mm
Active Area	108.0 (W) x 64.8 (L)	mm
Pixel Size	0.135 (W) * 0.135 (H)	mm

### Touch panel

Item	Standard Value	Unit
Viewing Area	110.4 (W) * 67.4 (L)	mm
Active Area	109.0 (W) * 65.8 (L)	mm

Note : For detailed information please refer to LCM drawing

### 1.3 Absolute Maximum Ratings

#### Module

Item	Symbol	Condition	Min.	Max.	Unit
System Power Supply Voltage	VDD	GND=0	-0.3	4.5	V
Operating Temperature	T <sub>OP</sub> (Ts)	Note 1	-20	70	°C
Storage Temperature	T <sub>ST</sub> (Ta)	Note 2	-30	80	°C
Storage Humidity	H <sub>D</sub>	Ta ≦ 60 °C	10	90	%RH

The absolute maximum rating values of this product are not allowed to be exceeded at any times. Should a module be used with any of the absolute maximum ratings exceeded, the characteristics of the module may not be recovered, or in an extreme case, the module may be permanently destroyed.

Note 1 : Ts is the temperature of panel's surface.

Note 2 : Ta is the ambient temperature of samples.

### 1.4 DC Electrical Characteristics

#### Module

GND = 0V, Ta = 25°C

Item	Symbol	Condition	Min.	Typ.	Max.	Unit
Power Supply Voltage	VDD	-	3.0	3.3	3.6	V
Input H/L Level Voltage	V <sub>IH</sub>	-	0.7VDD	-	VDD	V
	V <sub>IL</sub>	-	GND	-	0.3VDD	V
Output H/L Level Voltage	V <sub>OH</sub>	-	VDD-0.4	-	VDD	V
	V <sub>OL</sub>	-	GND	-	GND+0.4	V
Supply Current	I <sub>DD</sub>	VDD= 3.3 V Pattern=Photo	-	70	-	mA
		VDD= 3.3 V Pattern=RGB *1	-	90	140	mA

Note1:Maximum current display

## 1.5 Optical Characteristics

### TFT LCD Module

VDD= 3.3 V, Ta=25°C

Item		Symbol	Condition	Min.	Typ.	Max.	unit	-
Response time	Tr+Tf	25°C	-	-	30	45	ms	-
Viewing angle	Top	$\theta Y+$	CR $\geq$ 10		60	-	Deg.	Note 4
	Bottom	$\theta Y-$			60	-		
	Left	$\theta X-$			60	-		
	Right	$\theta X+$			60	-		
Contrast ratio		CR		500	600	-	-	Note 3
Color of CIE Coordinate (With B/L & LCD)	White	X	Ta = 25°C $\theta X, \theta Y = 0^\circ$	0.25	0.30	0.35	-	Note1
		Y		0.27	0.32	0.37		
	Red	X		0.51	0.56	0.61		
		Y		0.28	0.33	0.38		
	Green	X		0.29	0.34	0.39		
		Y		0.54	0.59	0.64		
	Blue	X		0.08	0.13	0.18		
		Y		0.03	0.08	0.13		
Average Brightness Pattern=white display (With LCD)*1		IV	IF= 40 mA	400	500	-	cd/m2	Note1
Uniformity (With LCD)*2		$\Delta B$	IF= 40 mA	70	-	-	%	Note1

Note 1:

\*1 :  $\Delta B = B(\text{min}) / B(\text{max}) * 100\%$

\*2 : Measurement Condition for Optical Characteristics:

a : Environment:  $25^{\circ}\text{C} \pm 5^{\circ}\text{C}$  /  $60 \pm 20\% \text{R.H}$  , no wind , dark room below 10 Lux at typical lamp current and typical operating frequency.

b : Measurement Distance:  $500 \pm 50$  mm , ( $\theta = 0^{\circ}$ )

c : Equipment: TOPCON BM-7 fast , (field  $1^{\circ}$ ) , after 10 minutes operation.

d : The uncertainty of the C.I.E coordinate measurement  $\pm 0.01$  , Average Brightness  $\pm 4\%$

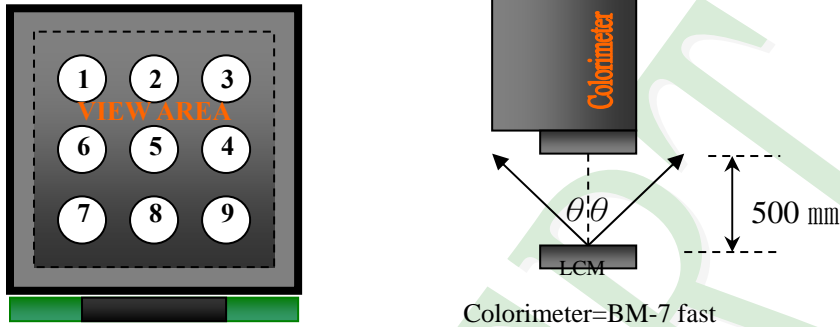

To be measured at the center area of panel with a viewing cone of  $1^{\circ}$  by Topcon luminance meter BM-7, after 10 minutes operation (module)

Note2: Definition of response time:

The output signals of photo detector are measured when the input signals are changed from "black" to "white"(falling time) and from "white" to "black"(rising time), respectively. The response time is defined as the time interval between the 10% and 90% of Amplitudes.

Refer to figure as below:

Normally White





### Normally Black

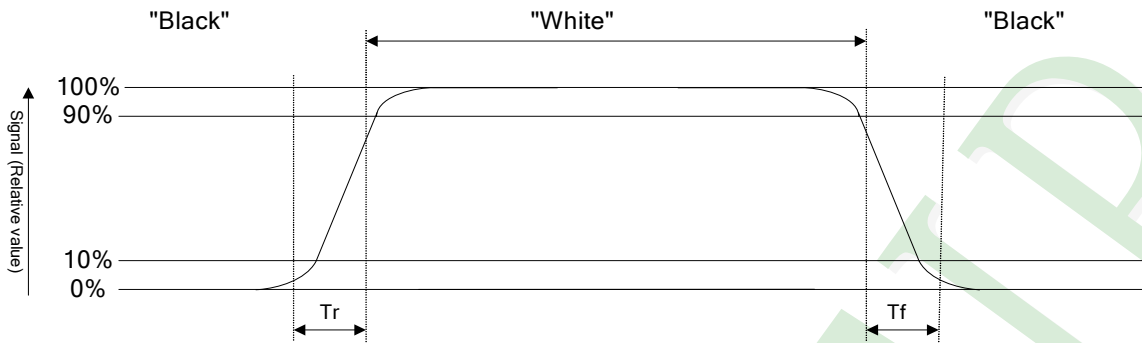

Note3: Definition of contrast ratio:

Contrast ratio is calculated with the following formula

$$\text{Contrast ratio (CR)} = \frac{\text{Photo detector output when LCD is at "White" state}}{\text{Photo detector output when LCD is at "Black" state}}$$

Note4: Definition of viewing angle:

Refer to figure as below:

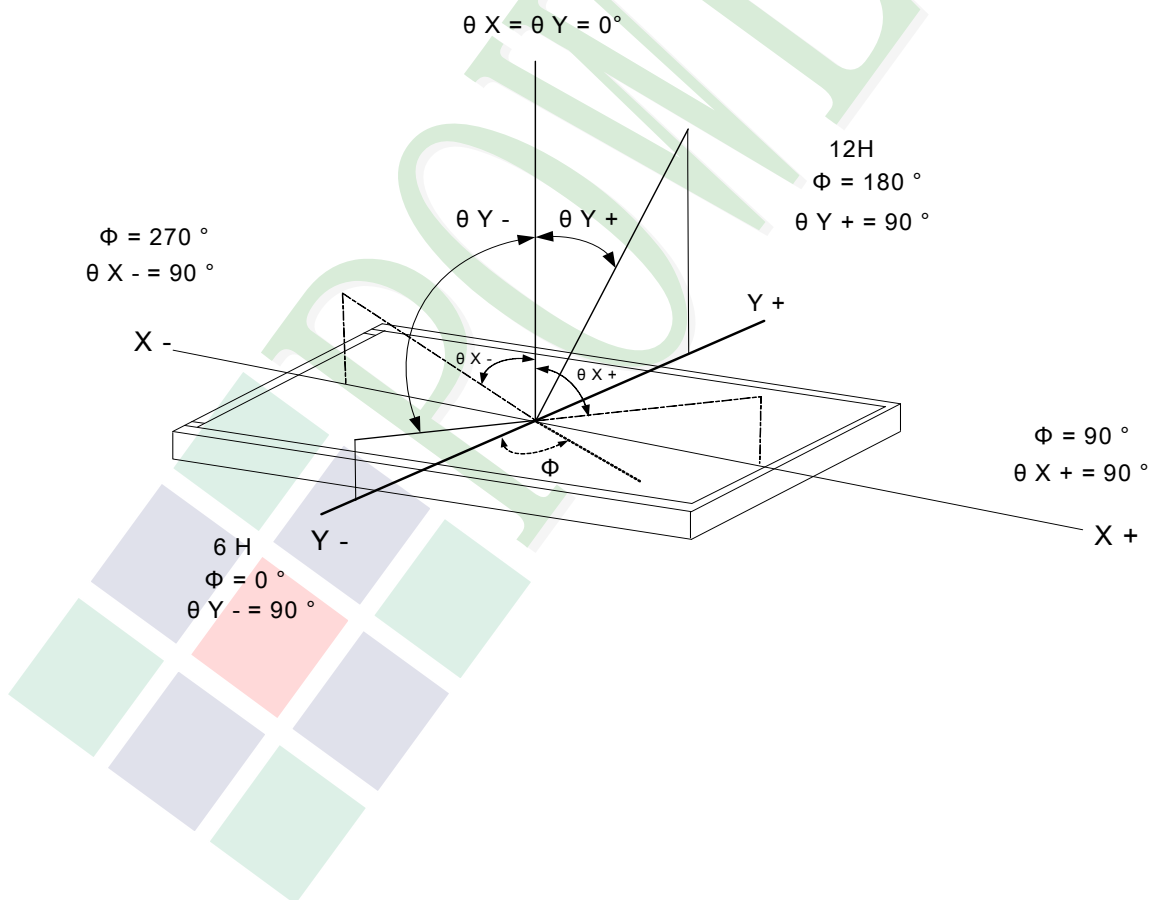

## 1.6 Backlight Characteristics

### Maximum Ratings

Item	Symbol	Conditions	Min.	Max.	Unit
LED Forward Current	IF	Ta =25°C	-	60	mA
LED Reverse Voltage	VR	Ta =25°C	-	7	V
Power Dissipation	PD	Ta =25°C	-	1782	mW

### Electrical / Optical Characteristics

Item	Symbol	Conditions	Min.	Typ.	Max.	Unit
Forward Voltage	VF	IF=40 mA	26.1	27.9	-	V
Average Brightness (Without LCD )	IV		13500	15500	-	cd/m <sup>2</sup>
CIE Color Coordinate (Without LCD )	X		0.25	0.28	0.31	-
	Y		0.25	0.28	0.31	
Color		White				

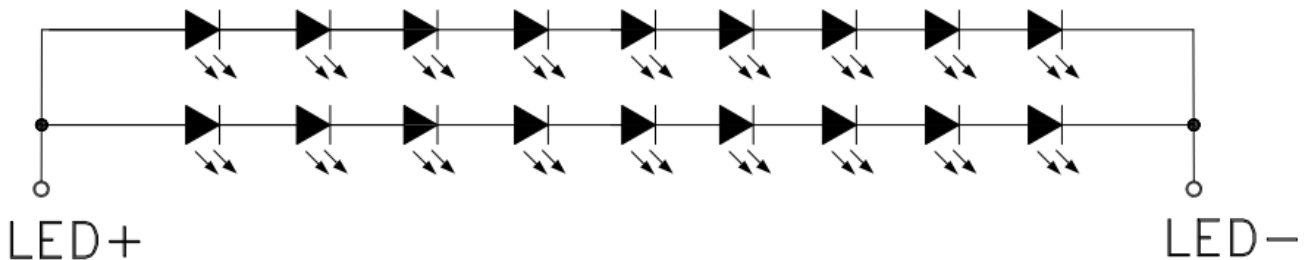

### Other Description

Item	Conditions	Description
Life Time	Ta =25°C IF= 40mA	50,000 hrs

## 1.7 Touch Panel Specification

### 1.7.1 Optical Characteristics

Item	Specification
1. Transparency	78% Min

### 1.7.2 Mechanical Characteristic

Item	Specification
1. Input Method	Finger or stylus pen
2. Hardness of surface	3H -pressure 500g of ,45deg.
3. Activation Force	120gf less individual point with stylus pen(R0.8) Activation force guarantee area:3.0mm inside of Active Area.
4. Linearity Force	120gf less input with stylus pen(R0.8) Activation force guarantee area:3.0mm inside of Active Area.

### 1.7.3 Electrical Characteristics

Item	Specification
1. Rated Voltage	DC 5V(DC 7V Max)
2. Resistance Between Terminals.	Direction X (Film side): 200Ω~ 1050Ω
	Direction Y (Glass side): 100Ω~ 900Ω
3. Insulation Resistance	20 MΩ or more (DC 25V 1min)
4. Linearity	±1.5%. Linearity(%)= $\Delta V / (EV - SV) * 100$ . $\Delta V$ : The difference between the ideal voltage and measured voltage on the each measuring line. SV: Voltage of starting Points. EV: Voltage of Ending Points. (Test condition refers to 1.7.2 item4)
5. Bouncing	<10ms (Tip R 3.75mm, hardness 10°~20° ,silicon rubber ,500gf operation : 40 mm/sec )

#### 1.7.4 Reliability Characteristic

NO	Test Item	Test Condition	Test Result
1	Hitting Durability	1,000,000times min.(R 8 mm Silicon Rubber Hardness 60°250gf 3times/sec).	Follow 1.7.3 item2 and item4.
2	Pen Sliding Durability	100,000 times min (TipR0.8mm).	Follow 1.7.3 item2 and item4.
3	Impact Resistance	φ9mm steel ball is dropped on the surface from 30 cm height at 1 time.	No Crack
4	Flexible pattern Bending Resistance	Bending 3 times by bending radius R1.0 mm	Follow 1.7.3 item2.

### 1.7.5 Touch Panel Design/Handing Guide

(1) Keep the gap, for example 0.2 to 0.3mm, between bezel edge and T/P edge.

The reason is to avoid the bezel edge from contacting T/P surface that may cause “short” with bottom layer

(2) Insertion a cushion material is recommended.

(3) The cushion material should be limited on the busbar insulation paste area. If it is over the transparent insulation paste area, a “short” may be occurred.

(4) Do not to use an adhesive tape to bond it on the front of T/P and hang it to the housing bezel.

(5) Never expand the T/P top layer (PET Film) like a balloon by internal air pressure. The life of the T/P will extremely decreasing.

(6) Top layer, PET, dimension is changing base on environment temperature and humidity. Please avoid a stress from housing bezel to top layer, because it may cause “waving”.

(7) The input to the Touch Panel sometimes distorts touch panel itself.

(8) To use the stylus pen or fingernail sliding at the edge of the housing is prohibited. It would cause the cracking of the ITO coating and damage the touch panel. It also request not to press this area while assembling

(9) Purpose: In order to prevent accidental use and performance deterioration, please keep the following precautions.

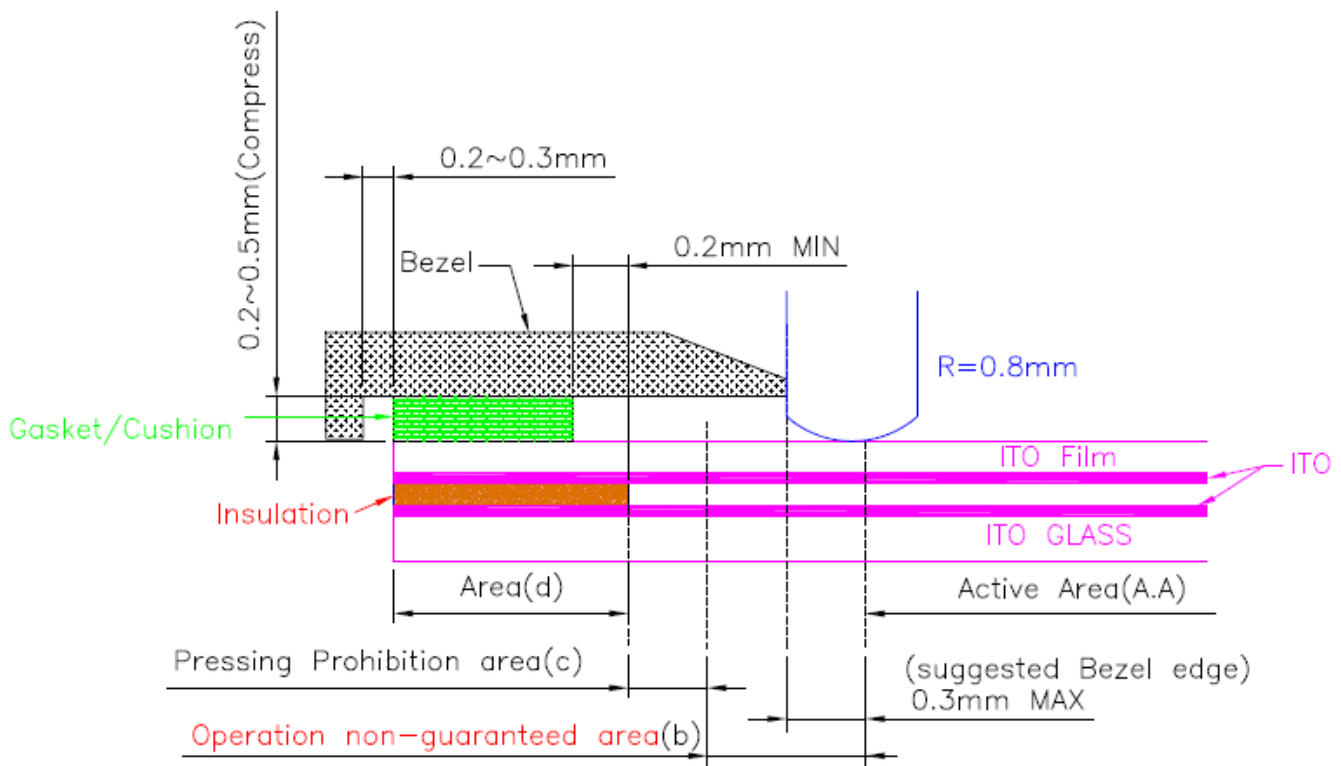

In order to prevent unusual performance degradation and malfunction of a touch panel, please carry out the set case designing and a touch panel assembling method after surely considering the definition of each area illustrated in above figure.

## 2. MODULE STRUCTURE

### 2.1 Counter Drawing

#### 2.1.1 LCM Mechanical Diagram

\* See Appendix

#### 2.1.2 Block Diagram

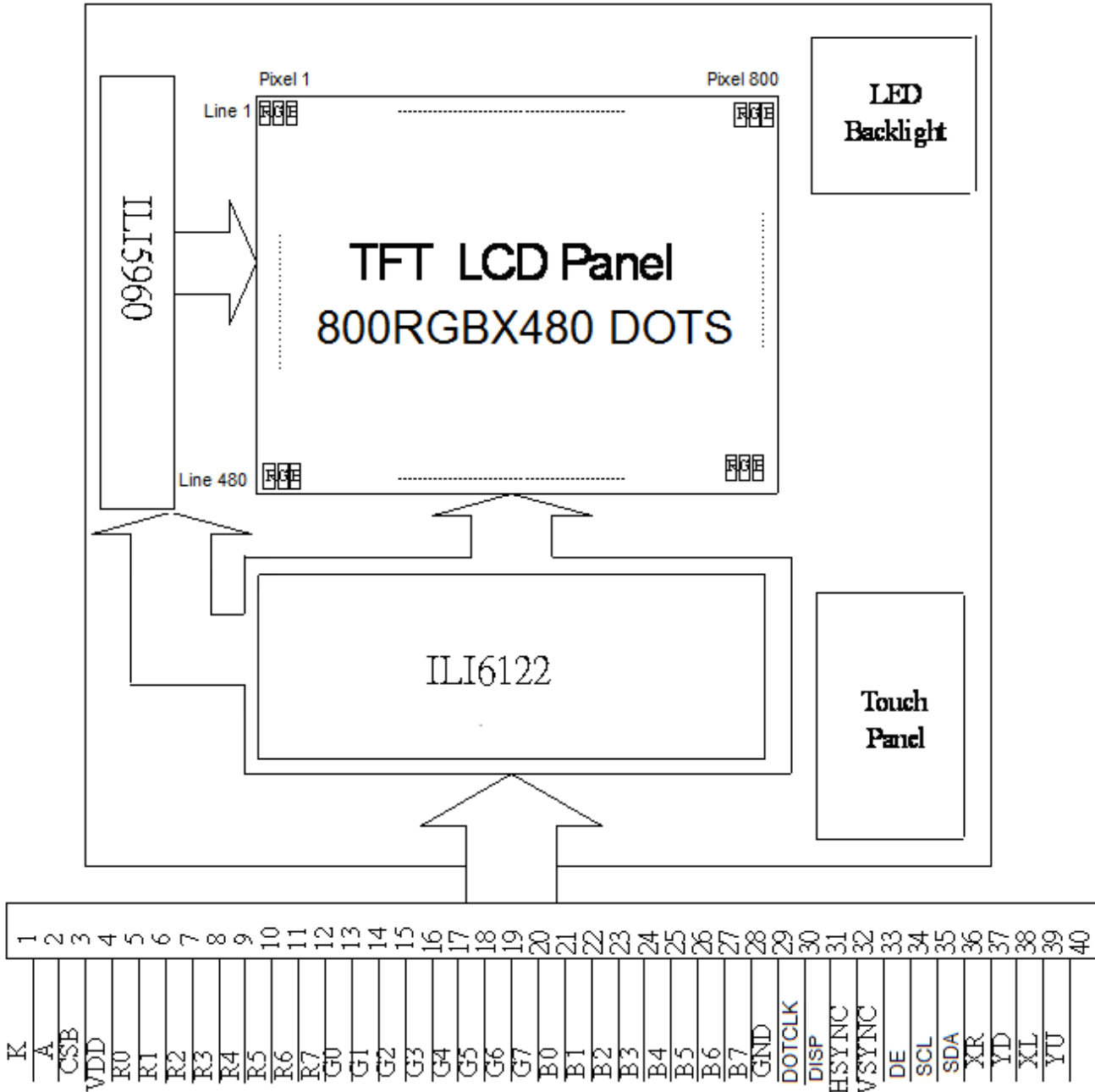

## 2.2 Interface Pin Description

Pin No.	Symbol	Function
1	LED-	Power supply for LED Backlight cathode input
2	LED+	Power supply for LED Backlight anode input
3	CS(NC)	Chip select pin of serial interface.
4	VDD	Digital power
5	R0	Red data bit 0
6	R1	Red data bit 1
7	R2	Red data bit 2
8	R3	Red data bit 3
9	R4	Red data bit 4
10	R5	Red data bit 5
11	R6	Red data bit 6
12	R7	Red data bit 7
13	G0	Green data bit 0
14	G1	Green data bit 1
15	G2	Green data bit 2
16	G3	Green data bit 3
17	G4	Green data bit 4
18	G5	Green data bit 5
19	G6	Green data bit 6
20	G7	Green data bit 7

Pin No.	Symbol	Function
21	B0	Blue data bit 0
22	B1	Blue data bit 1
23	B2	Blue data bit 2
24	B3	Blue data bit 3
25	B4	Blue data bit 4
26	B5	Blue data bit 5
27	B6	Blue data bit 6
28	B7	Blue data bit 7
29	GND	Ground
30	DOTCLK	Dot data clock, latching data at the rising edge
31	DISP	Display on/ off
32	HSYNC	Horizontal sync input, Default DE Mode Please Connect to GND
33	VSYNC	Vertical sync input, Default DE Mode Please Connect to GND
34	DE	Data enable
35	SCL(NC)	Data input and output in Serial communication/No connection when no using serial communication
36	SDA(NC)	Clock input in Serial communication / No connection when no using serial communication
37	XR	TP: X right
38	YD	TP: Y bottom
39	XL	TP: X left
40	YU	TP: Y top



## 2.3 Timing Characteristics

### 2.3.1 Vertical input timing

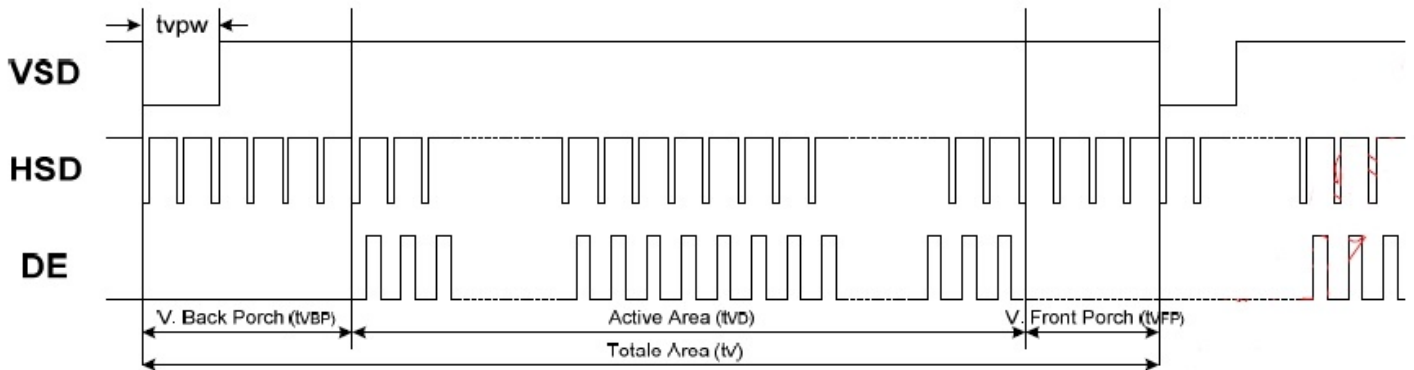

Parameter	Symbol	Value			Unit
		Min	Typ	Max	
Vertical display area	tvd		480		H
VSD period time	tv	510	525	650	H
VSD pulse width	tvpw	1	-	20	H
VSD Back Porch(Blanking)	tvb	23	23	23	H
VSD Front Proch	tvfb	7	22	147	H

### 2.3.2 Horizontal input timing

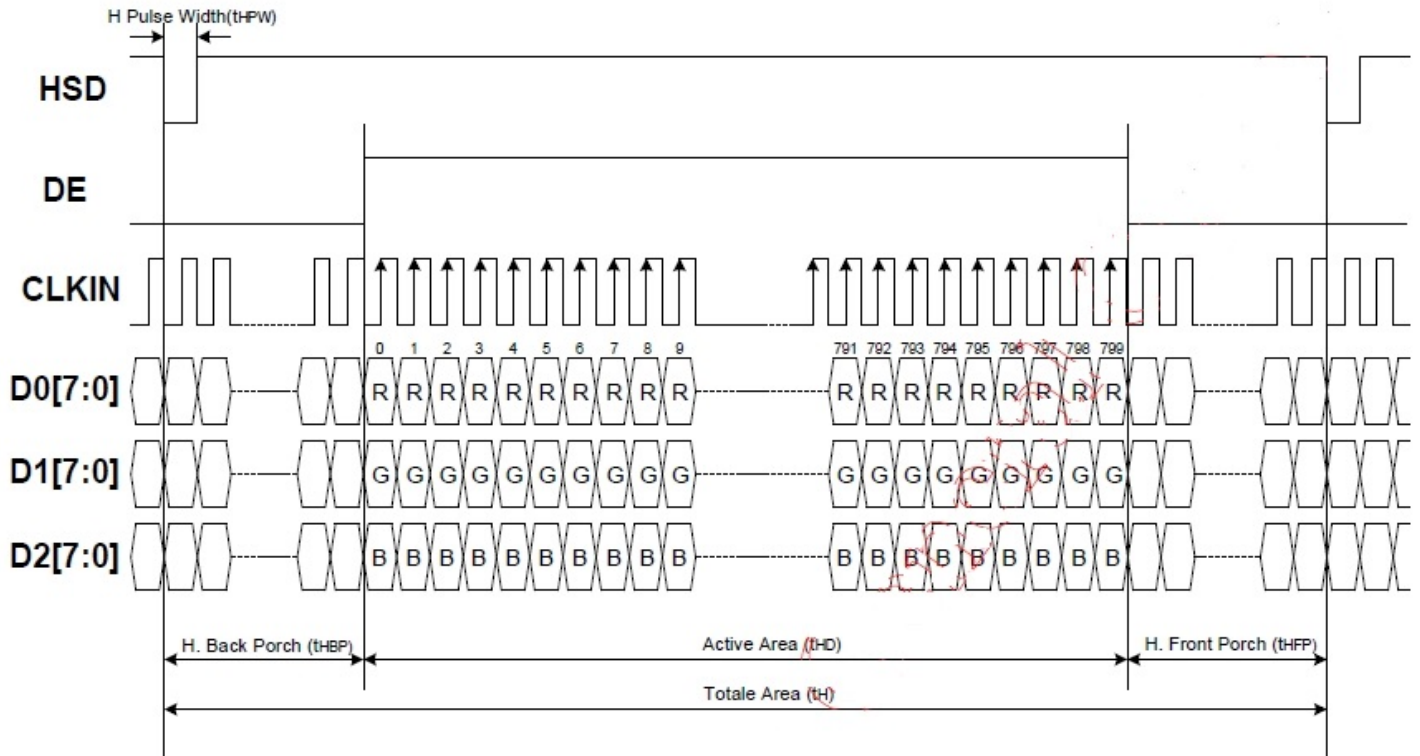

Parameter	Symbol	Value			Unit
		Min	Typ	Max	
Horizontal display area	thd		800		DCLK
DCLK frequency	fclk	-	33.3	50	MHz
1 Horizontal Line	th	862	1056	1200	DCLK
HSD pulse width	Min	-	1		
	Typ	-	-		
	Max	-	40		
HSD Back Porch (Blacking)	thp	46	46	46	
HSD Front Proch	thfb	16	210	354	

### 2.3.3 Input Clock and Data Timing DE Mode

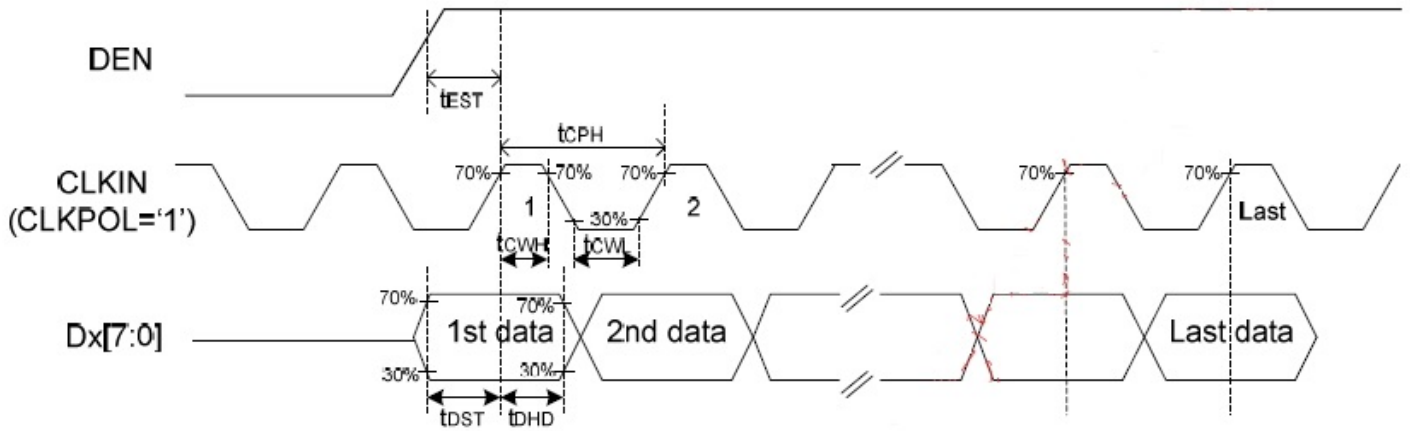

### SYNC Mode

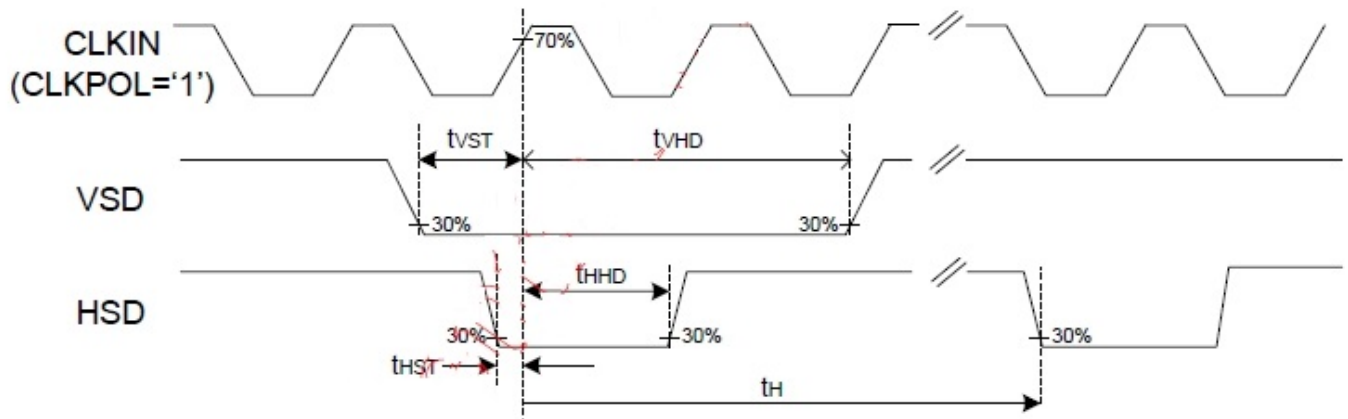

Parameter	Symbol	SPEC			Unit	Conditions
		Min	Typ.	Max		
VDD Power ON slew rate	tPOR	--	--	20	ms	0V ~ 0.9VDD
RSTB pulse width	tRST	10	--	--	us	CLKIN=50MHz
CLKIN cycle time	tCPH	20	--	--	ns	
CLKIN pulse duty	tCWH	40	50	60	%	
VSD setup time	tVST	8	--	--	ns	
VSD hold time	tVHD	8	--	--	ns	
HSD setup time	tHST	8	--	--	ns	
HSD hold time	tHHD	8	--	--	ns	
Data setup time	tDST	8	--	--	ns	D0[7:0], D1[7:0], D2[7:0] to CLKIN
Data hold time	tDHD	8	--	--	ns	D0[7:0], D1[7:0], D2[7:0] to CLKIN
DE setup time	tEST	8	--	--	ns	
DE hold time	tEHD	8	--	--	ns	
Output stable time	tSST	--	--	6	us	10% to 90% target voltage. CL=120pF, R=10KΩ
CLKIN frequency	fCLK	--	40	50	MHz	VDD=3.0 ~ 3.6V
CLKIN cycle time	tCLK	20	25	--	ns	
CLKIN pulse duty	tCWH	40	50	60	%	TCLK
Time from HSD to Source output	tHSO	--	20	--	CLKIN	
Time from HSD to LD	tHLD	--	20	--	CLKIN	Note (2)
Time from HSD to STV	tHSTV	--	2	--	CLKIN	
Time from HSD to CKV	tHCKV	--	20	--	CLKIN	
Time from HSD to OEV	tHOEV	--	4	--	CLKIN	
LD pulse width	tWLD	--	10	--	CLKIN	Note (2)
CKV pulse width	tWCKV	--	66	--	CLKIN	
OEV pulse width	tWEOEV	--	74	--	CLKIN	

Note: (1) VDD=3.0 ~ 3.6V, VDDA=6.5~13.5V, DGND=AGND=0V, Ta=-20~+85°C

(2) The contents of the data register are transferred to the latch circuit at the rising edge of LD. Then the gray scale voltage is output from the device at the falling edge of LD.

### 3. QUALITY ASSURANCE SYSTEM

#### 3.1 Quality Assurance Flow Chart

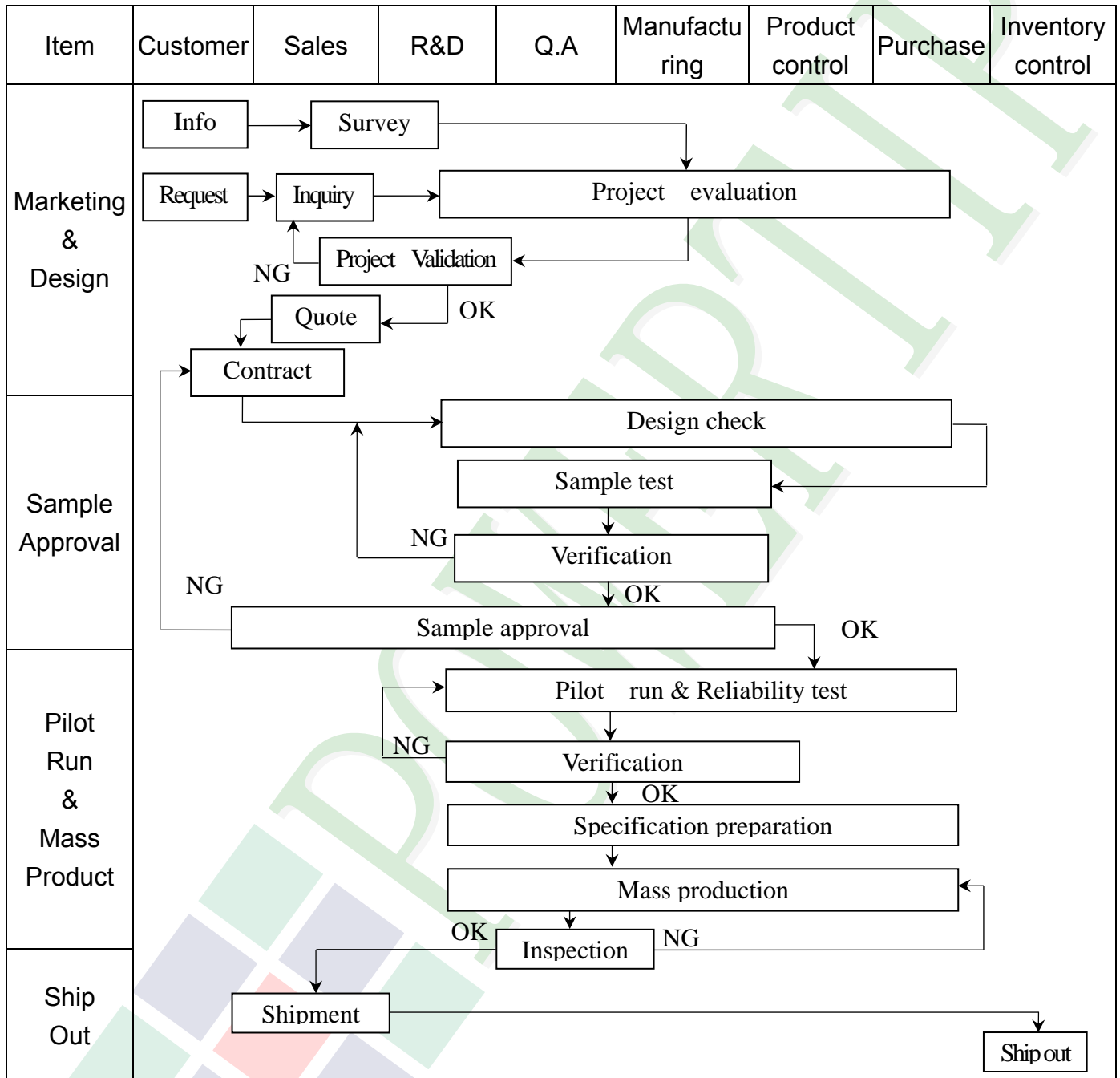

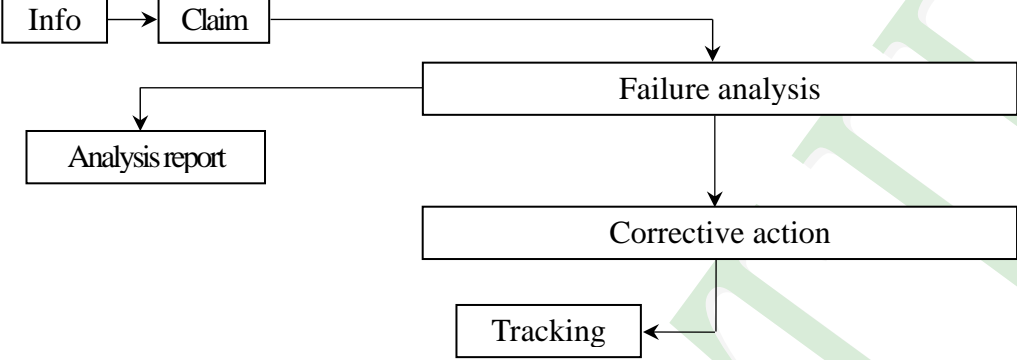
Item	Customer	Sales	R&D	Q.A	Manufacturing	Product control	Purchase	Inventory control
Sales Service	 <pre> graph TD     Info[Info] --&gt; Claim[Claim]     Claim --&gt; Failure[Failure analysis]     Failure --&gt; Analysis[Analysis report]     Failure --&gt; Corrective[Corrective action]     Corrective --&gt; Tracking[Tracking]           </pre>							
Q.A Activity	1. ISO 9001 Maintenance Activities 3. Equipment calibration 5. Standardization Management				2. Process improvement proposal 4. Education And Training Activities			

### 3.2. Inspection Specification

- ◆Scope: The document shall be applied to TFT-LCD Module for 3.5" -15" (Ver.B01).
- ◆Inspection Standard: MIL-STD-105E Table Normal Inspection Single Sampling Level II.
- ◆Equipment: Gauge, MIL-STD, Powertip Tester, Sample
- ◆Defect Level: Major Defect AQL: 0. 4; Minor Defect AQL: 1. 5
- ◆OUT Going Defect Level: Sampling.
- ◆Standard of the product appearance test:

a. Manner of appearance test:

- (1). The test best be under 20W×2 fluorescent light(about 300lux ~500lux)  
 , and distance of view must be at 30~40 cm.
- (2). The test direction is base on about around 45° of vertical line.

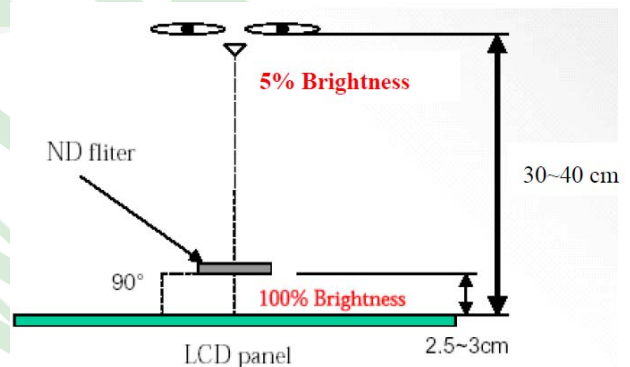
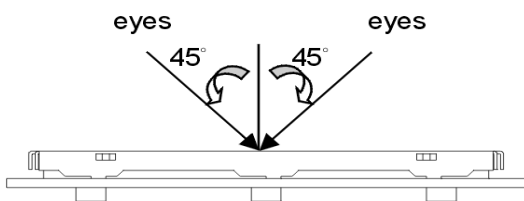

(3). Definition of area.

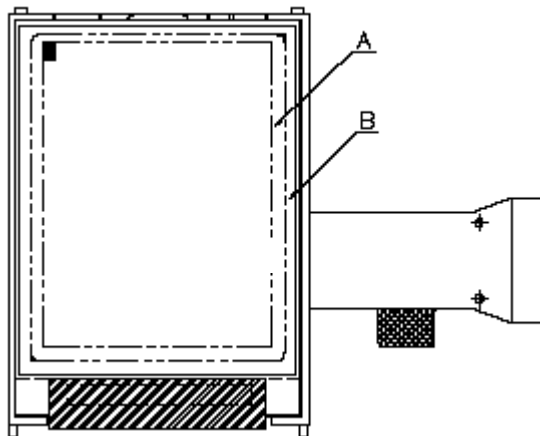

A area: viewing area

B area: Outside of viewing area

(4). Standard of inspection : (Unit : mm)

**◆Specification For TFT-LCD Module 3.5" ~15" :**
**(Ver.B01)**

NO	Item	Criterion	Level												
01	Product condition	1. 1The part number is inconsistent with work order of production.	Major												
		1. 2 Mixed product types.	Major												
		1. 3 Assembled in inverse direction.	Major												
02	Quantity	2. 1The quantity is inconsistent with work order of production.	Major												
03	Outline dimension	3. 1Product dimension and structure must conform to structure diagram.	Major												
04	Electrical Testing	4. 1 Missing line character and icon.	Major												
		4. 2 No function or no display.	Major												
		4. 3 Display malfunction.	Major												
		4. 4 LCD viewing angle defect.	Major												
		4. 5 Current consumption exceeds product specifications.	Major												
		4. 6Mura cannot be seen through 5% ND filter at 50% Gray , should be judged by the viewing angle of 90 degree.	Minor												
05	Dot defect (Bright dot, Dark dot)  On -display	<table border="1"> <thead> <tr> <th></th> <th>Item</th> <th>Acceptance (Q'ty)</th> </tr> </thead> <tbody> <tr> <td rowspan="4">Dot Defect</td> <td>Bright Dot</td> <td><math>\leq 4</math></td> </tr> <tr> <td>Dark Dot</td> <td><math>\leq 5</math></td> </tr> <tr> <td>Joint Dot</td> <td><math>\leq 3</math></td> </tr> <tr> <td>Total</td> <td><math>\leq 7</math></td> </tr> </tbody> </table>		Item	Acceptance (Q'ty)	Dot Defect	Bright Dot	$\leq 4$	Dark Dot	$\leq 5$	Joint Dot	$\leq 3$	Total	$\leq 7$	Minor
			Item	Acceptance (Q'ty)											
Dot Defect	Bright Dot	$\leq 4$													
	Dark Dot	$\leq 5$													
	Joint Dot	$\leq 3$													
	Total	$\leq 7$													
5. 1 Inspection pattern: full white, full black, Red, Green and blue screens. 5. 2 It is defined as dot defect if defect area $> 1/2$ dot. 5. 3 The distance between two dot defect $\geq 5$ mm. 5. 4 Bright dot that can not be seen through 5% ND filter.															



**◆Specification For TFT-LCD Module 3.5" ~15" :**

(Ver.B01)

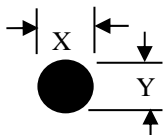
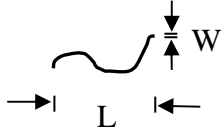
NO	Item	Criterion	Level																																																								
06	Black or white Dot, scratch, contamination  Round type    $\Phi = (x + y) / 2$  Line type  	6. 1 Round type (Non-display or display):  <table border="1"> <thead> <tr> <th rowspan="2">Dimension (diameter : <math>\Phi</math>)</th> <th colspan="2">Acceptance (Q'ty)</th> </tr> <tr> <th>A area</th> <th>B area</th> </tr> </thead> <tbody> <tr> <td><math>\Phi \leq 0.25</math></td> <td colspan="2">Ignore</td> </tr> <tr> <td><math>0.25 &lt; \Phi \leq 0.50</math></td> <td>5</td> <td rowspan="3">Ignore</td> </tr> <tr> <td><math>\Phi &gt; 0.50</math></td> <td>0</td> </tr> <tr> <td><b>Total</b></td> <td><b>5</b></td> </tr> </tbody> </table>  6. 2 Line type(Non-display or display):  <table border="1"> <thead> <tr> <th rowspan="2">module size</th> <th rowspan="2">Length (L)</th> <th rowspan="2">Width (W)</th> <th colspan="2">Acceptance (Q'ty)</th> </tr> <tr> <th>A area</th> <th>B area</th> </tr> </thead> <tbody> <tr> <td rowspan="4">3.5" to less 9"</td> <td>---</td> <td><math>W \leq 0.03</math></td> <td>Ignore</td> <td rowspan="4">Ignore</td> </tr> <tr> <td><math>L \leq 10.0</math></td> <td><math>0.03 &lt; W \leq 0.05</math></td> <td>4</td> </tr> <tr> <td><math>L \leq 5.0</math></td> <td><math>0.05 &lt; W \leq 0.10</math></td> <td>2</td> </tr> <tr> <td>---</td> <td><math>W &gt; 0.10</math></td> <td>As round type</td> </tr> <tr> <td colspan="3"><b>Total</b></td> <td><b>5</b></td> <td></td> </tr> <tr> <td rowspan="4">9" to 15"</td> <td>---</td> <td><math>W \leq 0.05</math></td> <td>Ignore</td> <td rowspan="4">Ignore</td> </tr> <tr> <td><math>L \leq 10.0</math></td> <td><math>0.05 &lt; W \leq 0.10</math></td> <td>5</td> </tr> <tr> <td>---</td> <td><math>W &gt; 0.10</math></td> <td>As round type</td> </tr> <tr> <td colspan="3"><b>Total</b></td> <td><b>5</b></td> </tr> </tbody> </table>	Dimension (diameter : $\Phi$ )	Acceptance (Q'ty)		A area	B area	$\Phi \leq 0.25$	Ignore		$0.25 < \Phi \leq 0.50$	5	Ignore	$\Phi > 0.50$	0	<b>Total</b>	<b>5</b>	module size	Length (L)	Width (W)	Acceptance (Q'ty)		A area	B area	3.5" to less 9"	---	$W \leq 0.03$	Ignore	Ignore	$L \leq 10.0$	$0.03 < W \leq 0.05$	4	$L \leq 5.0$	$0.05 < W \leq 0.10$	2	---	$W > 0.10$	As round type	<b>Total</b>			<b>5</b>		9" to 15"	---	$W \leq 0.05$	Ignore	Ignore	$L \leq 10.0$	$0.05 < W \leq 0.10$	5	---	$W > 0.10$	As round type	<b>Total</b>			<b>5</b>	Minor
Dimension (diameter : $\Phi$ )	Acceptance (Q'ty)																																																										
	A area	B area																																																									
$\Phi \leq 0.25$	Ignore																																																										
$0.25 < \Phi \leq 0.50$	5	Ignore																																																									
$\Phi > 0.50$	0																																																										
<b>Total</b>	<b>5</b>																																																										
module size	Length (L)	Width (W)	Acceptance (Q'ty)																																																								
			A area	B area																																																							
3.5" to less 9"	---	$W \leq 0.03$	Ignore	Ignore																																																							
	$L \leq 10.0$	$0.03 < W \leq 0.05$	4																																																								
	$L \leq 5.0$	$0.05 < W \leq 0.10$	2																																																								
	---	$W > 0.10$	As round type																																																								
<b>Total</b>			<b>5</b>																																																								
9" to 15"	---	$W \leq 0.05$	Ignore	Ignore																																																							
	$L \leq 10.0$	$0.05 < W \leq 0.10$	5																																																								
	---	$W > 0.10$	As round type																																																								
	<b>Total</b>				<b>5</b>																																																						
07	Polarizer Bubble	<table border="1"> <thead> <tr> <th rowspan="2">Dimension (diameter: <math>\Phi</math>)</th> <th colspan="2">Acceptance (Q'ty)</th> </tr> <tr> <th>A area</th> <th>B area</th> </tr> </thead> <tbody> <tr> <td><math>\Phi \leq 0.25</math></td> <td colspan="2">Ignore</td> </tr> <tr> <td><math>0.25 &lt; \Phi \leq 0.50</math></td> <td>4</td> <td rowspan="3">Ignore</td> </tr> <tr> <td><math>0.50 &lt; \Phi \leq 0.80</math></td> <td>1</td> </tr> <tr> <td><math>\Phi &gt; 0.80</math></td> <td>0</td> </tr> <tr> <td><b>Total</b></td> <td><b>5</b></td> <td></td> </tr> </tbody> </table>	Dimension (diameter: $\Phi$ )	Acceptance (Q'ty)		A area	B area	$\Phi \leq 0.25$	Ignore		$0.25 < \Phi \leq 0.50$	4	Ignore	$0.50 < \Phi \leq 0.80$	1	$\Phi > 0.80$	0	<b>Total</b>	<b>5</b>		Minor																																						
Dimension (diameter: $\Phi$ )	Acceptance (Q'ty)																																																										
	A area	B area																																																									
$\Phi \leq 0.25$	Ignore																																																										
$0.25 < \Phi \leq 0.50$	4	Ignore																																																									
$0.50 < \Phi \leq 0.80$	1																																																										
$\Phi > 0.80$	0																																																										
<b>Total</b>	<b>5</b>																																																										

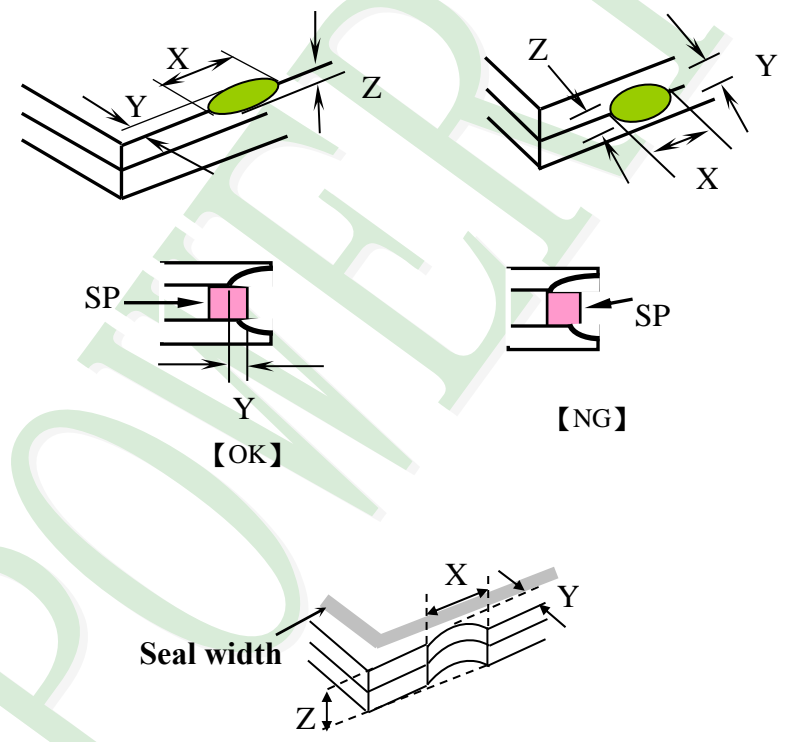
NO	Item	Criterion	Level						
08	The crack of glass	<p><b>Symbols :</b></p> <p><b>X:</b> The length of crack  <b>Z:</b> The thickness of crack  <b>t:</b> The thickness of glass</p> <p><b>Y:</b> The width of crack.  <b>W:</b> terminal length  <b>a:</b> LCD side length</p>	Minor						
		<p>8.1 General glass chip:              8.1.1 Chip on panel surface and crack between panels:</p>  <table border="1" data-bbox="539 1579 1353 1870"> <thead> <tr> <th>X</th> <th>Y</th> <th>Z</th> </tr> </thead> <tbody> <tr> <td><math>\leq a</math></td> <td>Crack can't enter viewing area</td> <td><math>\leq 1/2 t</math></td> </tr> <tr> <td><math>\leq a</math></td> <td>Crack can't exceed the half of SP width.</td> <td><math>1/2 t &lt; Z \leq 2 t</math></td> </tr> </tbody> </table>		X	Y	Z	$\leq a$	Crack can't enter viewing area	$\leq 1/2 t$
X	Y	Z							
$\leq a$	Crack can't enter viewing area	$\leq 1/2 t$							
$\leq a$	Crack can't exceed the half of SP width.	$1/2 t < Z \leq 2 t$							

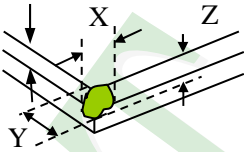
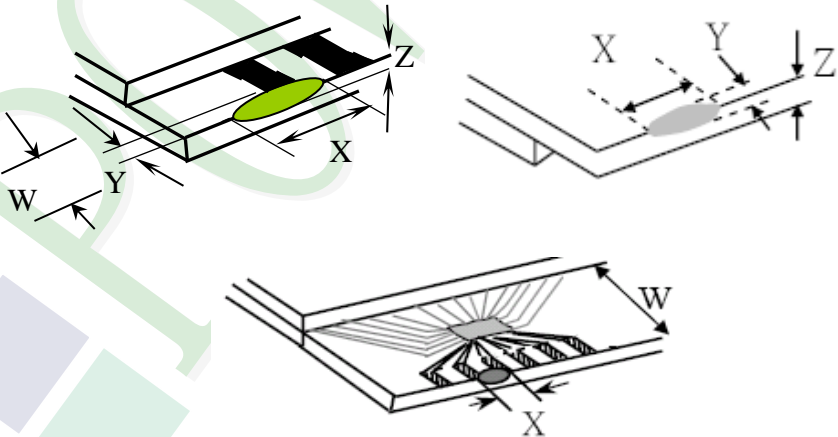
NO	Item	Criterion	Level												
08	The crack of glass	<p><b>Symbols :</b></p> <p><b>X:</b> The length of crack  <b>Z:</b> The thickness of crack  <b>t:</b> The thickness of glass</p> <p><b>Y:</b> The width of crack.  <b>W:</b> terminal length  <b>a:</b> LCD side length</p> <hr/> <p>8.1.2 Corner crack:</p>  <table border="1" data-bbox="520 763 1337 1055"> <thead> <tr> <th>X</th> <th>Y</th> <th>Z</th> </tr> </thead> <tbody> <tr> <td><math>\leq 1/5 a</math></td> <td>Crack can't enter viewing area</td> <td><math>Z \leq 1/2 t</math></td> </tr> <tr> <td><math>\leq 1/5 a</math></td> <td>Crack can't exceed the half of SP width.</td> <td><math>1/2 t &lt; Z \leq 2 t</math></td> </tr> </tbody> </table>	X	Y	Z	$\leq 1/5 a$	Crack can't enter viewing area	$Z \leq 1/2 t$	$\leq 1/5 a$	Crack can't exceed the half of SP width.	$1/2 t < Z \leq 2 t$				
		X	Y	Z											
$\leq 1/5 a$	Crack can't enter viewing area	$Z \leq 1/2 t$													
$\leq 1/5 a$	Crack can't exceed the half of SP width.	$1/2 t < Z \leq 2 t$													
		<p>8.2 Protrusion over terminal:</p> <p>8.2.1 Chip on electrode pad:</p>  <table border="1" data-bbox="560 1697 1347 1872"> <thead> <tr> <th></th> <th>X</th> <th>Y</th> <th>Z</th> </tr> </thead> <tbody> <tr> <td>Front</td> <td><math>\leq a</math></td> <td><math>\leq 1/2 W</math></td> <td><math>\leq t</math></td> </tr> <tr> <td>Back</td> <td><math>\leq a</math></td> <td><math>\leq W</math></td> <td><math>\leq 1/2 t</math></td> </tr> </tbody> </table>		X	Y	Z	Front	$\leq a$	$\leq 1/2 W$	$\leq t$	Back	$\leq a$	$\leq W$	$\leq 1/2 t$	Minor
	X	Y	Z												
Front	$\leq a$	$\leq 1/2 W$	$\leq t$												
Back	$\leq a$	$\leq W$	$\leq 1/2 t$												



**◆ Specification For TFT-LCD Module 3.5" ~15" :**
**(Ver.B01)**

NO	Item	Criterion	Level
09	Backlight elements	9. 1 Backlight can't work normally.	Major
		9. 2 Backlight doesn't light or color is wrong.	Major
		9. 3 Illumination source flickers when lit.	Major
10	General appearance	10. 1 Pin type 、 quantity 、 dimension must match type in structure diagram.	Major
		10. 2 No short circuits in components on PCB or FPC.	Major
		10. 3 Parts on PCB or FPC must be: no wrong parts, missing parts or excess parts.	Major
		10. 4 Product packaging must the same as specified on packaging specification sheet.	Minor
		10. 5 The folding and peeled off in polarizer are not acceptable.	Minor
		10. 6 The PCB or FPC between B/L assembled distance(PCB or FPC ) is $\leq 1.5$ mm.	Minor



## 5. PRECAUTION RELATING PRODUCT HANDLING

### 5.1 SAFETY

- 5.1.1 If the LCD panel breaks , be careful not to get the liquid crystal to touch your skin.
- 5.1.2 If the liquid crystal touches your skin or clothes , please wash it off immediately by using soap and water.

### 5.2 HANDLING

- 5.2.1 Avoid any strong mechanical shock which can break the glass.
- 5.2.2 Avoid static electricity which can damage the CMOS LSI—When working with the module , be sure to ground your body and any electrical equipment you may be using.
- 5.2.3 Do not remove the panel or frame from the module.
- 5.2.4 The polarizing plate of the display is very fragile. So , please handle it very carefully, do not touch , push or rub the exposed polarizing with anything harder than an HB pencil lead (glass , tweezers , etc.)
- 5.2.5 Do not wipe the polarizing plate with a dry cloth , as it may easily scratch the surface of plate.
- 5.2.6 Do not touch the display area with bare hands , this will stain the display area.
- 5.2.7 Do not use ketonics solvent & aromatic solvent. Use with a soft cloth soaked with a cleaning naphtha solvent.
- 5.2.8 To control temperature and time of soldering is  $320 \pm 10^{\circ}\text{C}$  and 3-5 sec.
- 5.2.9 To avoid liquid (include organic solvent) stained on LCM
- 5.2.10 Caution! ( LCM products with Capacitive Touch Panel)
  - Strong EMI-sources such as switch-mode power supplies (SMPS) can lead to touch malfunction (e.g. ghost-touches).
  - Therefore, the touch needs to be thoroughly tested inside the target application.
- 5.2.11 Caution: Continuously displaying same static image will result in high possibility of image sticking/image burn-in effect due to TFT panel characteristic.

### 5.3 STORAGE

- 5.3.1 Store the panel or module in a dark place where the temperature is  $25^{\circ}\text{C} \pm 5^{\circ}\text{C}$  and the humidity is below 65% RH.
- 5.3.2 Do not place the module near organics solvents or corrosive gases.
- 5.3.3 Do not crush , shake , or jolt the module.

### 5.4 TERMS OF WARRANTY

- 5.4.1 Applicable warrant period
  - The period is within thirteen months since the date of shipping out under normal using and storage conditions.
- 5.4.2 Unaccepted responsibility
  - This product has been manufactured to your company's specification as a part for use in your company's general electronic products. It is guaranteed to perform according to delivery specifications. For any other use apart from general electronic equipment, we cannot take responsibility if the product is used in nuclear power control equipment, aerospace equipment , fire and security systems or any other applications in which there is a direct risk to human life and where extremely







1. 包裝材料規格表 (Packaging Material) : (per carton)

No.	Item	Model	Dimensions (mm)	1Pcs Weight	Quantity	Total Weight
1	成品 (LCM)	PH800480T024-ICB01	121.0 X 75.9	0.0747	144	10.7568
2	多層薄膜(1)POF	OTFILM0BA03ABA	19"X350X0.015	—	6	—
3	TRAY 盤 (2)Tray	TYSG000000187	352 X 260 X 12.8	0.0965	42	4.053
4	舒美墊(3) EPE	FOAM000000047	350 X 255 X 5	0.011	6	0.066
5	內盒(4)Product Box	BX36627063ABBA	383 X 270 X 66	0.182	6	1.092
6	保利龍板(5)Polylon board	OTPLB00PL08ABA	550 X 393 X 20	0.0284	2	0.0568
7	外紙箱(6)Carton	BX57041027CCBA	570 X 410 X 265	1.0	1	1.0
8						
9						

2. 一整箱總重量 (Total LCD Weight in carton) : 17.02 Kg±10%

3. 單箱數量規格表 (Packaging Specifications and Quantity) :

(1) LCM quantity per box : no per tray	4	x no of tray	6	=	24
(2) Total LCM quantity in carton : quantity per box	24	x no of boxes	6	=	144

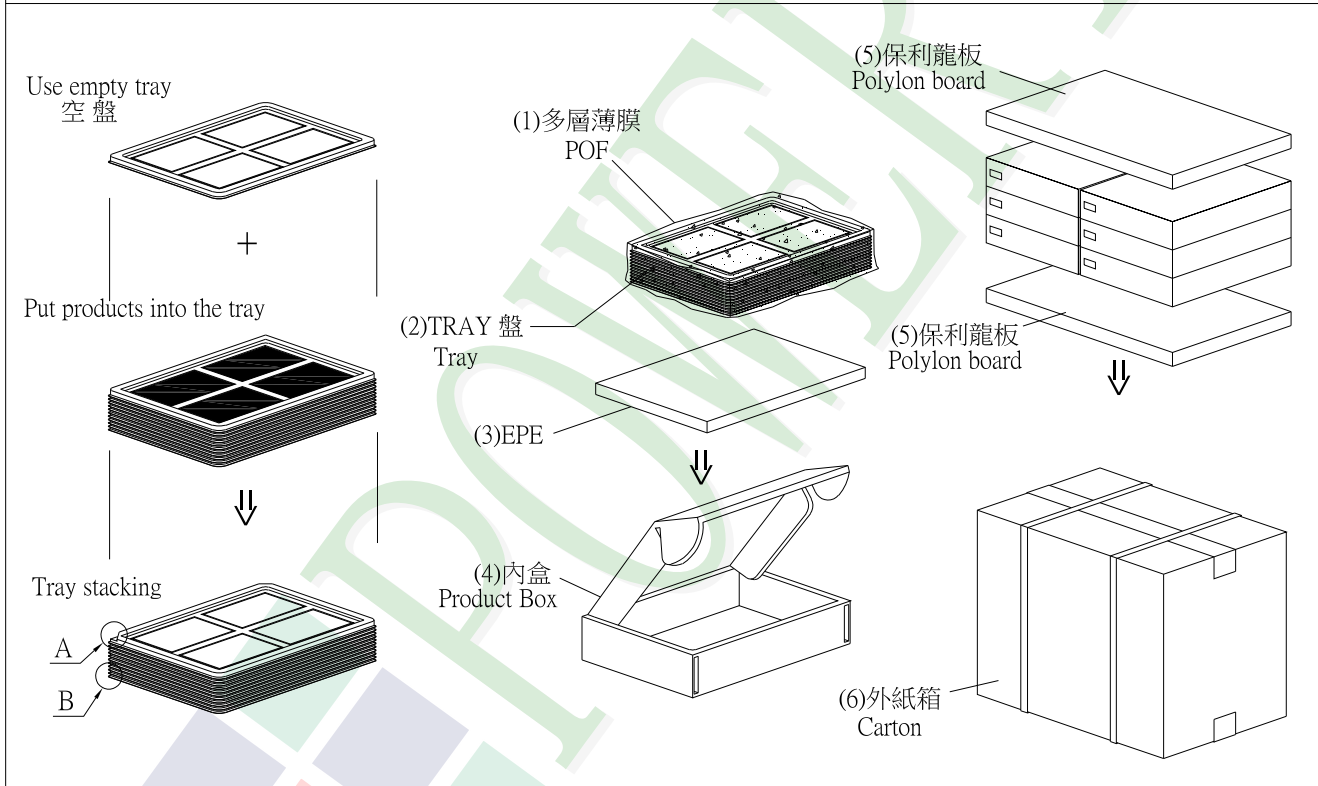

特 記 事 項 (REMARK)

	<p>5. 外購Tray: TY00000000308 自製Tray: TYSG000000187</p>	
<p>4. TRAY盤相疊時, 需旋轉180度, 請詳見B視圖 Rotate tray 180 degrees and place on top of stack. Check the tray stack using Fig. B.</p>		