

SPECIFICATIONS

CUSTOMER	:	_____
SAMPLE CODE	:	SH800480T013-IHA06
MASS PRODUCTION CODE	:	PH800480T013-IHA06
SAMPLE VERSION	:	01
SPECIFICATIONS EDITION	:	002
DRAWING NO. (Ver.)	:	LMD-PH800480T013-IHA06 (Ver.001)
PACKAGING NO. (Ver.)	:	PKG-PH800480T013-IHA06 (Ver.001)

Customer Approved

Date:

Approved	Checked	Designer
黃秋源 Oliver Huang	石建莊 Stone Shin	王聖硯 Stephen Wang

- Preliminary specification for design input
- Specification for sample approval

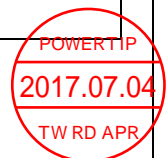

POWERTIP TECH. CORP.

Headquarters:

No.8, 6th Road, Taichung Industrial Park,
Taichung, Taiwan
台中市 407 工業區六路 8 號

TEL: 886-4-2355-8168
FAX: 886-4-2355-8166

E-mail: sales@powertip.com.tw
[Http://www.powertip.com.tw](http://www.powertip.com.tw)

History of Version

Date (mm / dd / yyyy)	Ver.	Edi.	Description	Page	Design by
05/19/2017	01	001	New Sample	-	Stephen
07/03/2017	01	002	Modify Outline Dimension	4	Stephen

Total: 28 Page

Contents

1. SPECIFICATIONS

- 1.1 Features
- 1.2 Mechanical Specifications
- 1.3 Absolute Maximum Ratings
- 1.4 DC Electrical Characteristics
- 1.5 Optical Characteristics
- 1.6 Backlight Characteristics

2. MODULE STRUCTURE

- 2.1 Counter Drawing
- 2.2 Interface Pin Description
- 2.3 HDMI Characteristics

3. QUALITY ASSURANCE SYSTEM

- 3.1 Quality Assurance Flow Chart
- 3.2 Inspection Specification

4. RELIABILITY TEST

- 4.1 Reliability Test Condition

5. PRECAUTION RELATING PRODUCT HANDLING

- 5.1 Safety
- 5.2 Handling
- 5.3 Storage
- 5.4 Terms of Warranty

Appendix : LCM Drawing.
LCM Packaging Specifications

1. SPECIFICATIONS

1.1 Features

Item	Standard Value
Display Resolution	800 *3 (RGB) * 480 Dots
LCD Type	a-Si TFT , Normally white , Transmissive type
Screen size(inch)	7.0 inch
Viewing Direction	6 O'clock
LCD Surface treatment	Anti-Glare
Color configuration	R.G.B. Vertical Stripe
Backlight Type	White LED B/L
Interface	HDMI Interface
ROHS	THIS PRODUCT CONFORMS THE ROHS OF PTC Detail information please refer website : http://www.powertip.com.tw/news_detail.php?Key=1&cID=1

1.2 Mechanical Specifications

Item	Standard Value	Unit
Outline Dimension	164.9 (W) * 100.0 (L) * 18.56 (H)	mm

LCD panel

Item	Standard Value	Unit
Active Area	154.08 (W) * 85.92 (L)	mm

Note : For detailed information please refer to LCM drawing.

1.3 Absolute Maximum Ratings

Module

Item	Symbol	Condition	Min.	Max.	Unit
Power Supply for Digital circuit	V5V	GND=0V	-0.3	+6.0	V
Power Supply for Analog circuit	V12V	GND=0V	-0.3	+26.0	V
Operating Temperature	T _{OP}	-	-20	+70	°C
Storage Temperature	T _{ST}	-	-30	+80	°C

The absolute maximum rating values of this product are not allowed to be exceeded at any times. Should a module be used with any of the absolute maximum ratings exceeded, the characteristics of the module may not be recovered, or in an extreme case, the module may be permanently destroyed.

1.4 DC Electrical Characteristics

Module

GND = 0V, Ta = 25 °C

Item	Symbol	Min.	Typ.	Max.	Unit	Remark
Input signal Voltage	V _{12V}	11.5	12.0	12.5	V	-
Supply Current	I _{V12V}	-	-	1500	mA	Pattern = Full Display

1.5 Optical Characteristics

TFT LCD Module

Ta=25°C

Item		Symbol	Condition	Min.	Typ.	Max.	unit	
Response time	Rise	Tr	Ta = 25°C θX, θY = 0°	-	10	20	ms	Note 2
	Fall	Tf		-	15	30		
Viewing angle	Top	θY+	CR ≥ 10	40	50	-	Deg.	Note 4
	Bottom	θY-		60	70	-		
	Left	θX-		60	70	-		
	Right	θX+		60	70	-		
Contrast ratio		CR		400	500	-	-	Note 3
Color of CIE Coordinate (With B/L)	White	X	Ta = 25°C θX , θY = 0°	0.24	0.29	0.34	-	Note1
		Y		0.27	0.32	0.37		
	Red	X		0.52	0.57	0.62		
		Y		0.30	0.35	0.40		
	Green	X		0.29	0.34	0.39		
		Y		0.54	0.59	0.64		
	Blue	X		0.09	0.14	0.19		
		Y		0.03	0.08	0.13		
Average Brightness Pattern=white display (With LCD) *1		IV	V12V=12.0V PWM="High" (Duty=100%)	800	1000	-	cd/m ²	Note1
Uniformity (With LCD) *2		△B		70	-	-	%	Note1

Note 1:

*1 : $\Delta B = B(\min) / B(\max) * 100\%$

*2 : Measurement Condition for Optical Characteristics:

a : Environment: $25^{\circ}\text{C} \pm 5^{\circ}\text{C}$ / $60 \pm 20\% \text{R.H}$, no wind , dark room below 10 Lux at typical lamp current and typical operating frequency.

b : Measurement Distance: $500 \pm 50 \text{ mm}$, ($\theta = 0^{\circ}$)

c : Equipment: TOPCON BM-7 fast , (field 1°) , after 10 minutes operation.

d : The uncertainty of the C.I.E coordinate measurement ± 0.01 , Average Brightness $\pm 4\%$

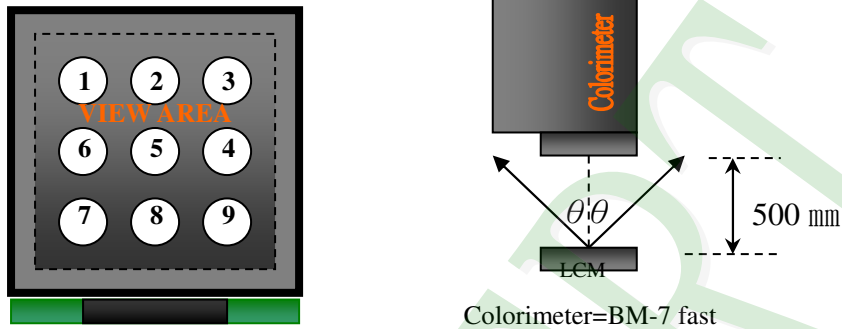

To be measured at the center area of panel with a viewing cone of 1° by Topcon luminance meter BM-7, after 10 minutes operation (module)

Note2: Definition of response time:

The output signals of photo detector are measured when the input signals are changed from "black" to "white"(falling time) and from "white" to "black"(rising time), respectively. The response time is defined as the time interval between the 10% and 90% of Amplitudes.

Refer to figure as below:

Normally White



Normally Black

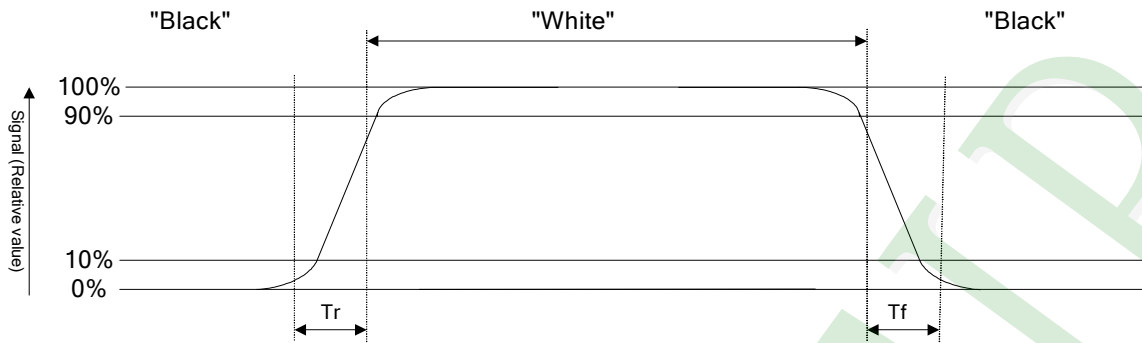

Note3: Definition of contrast ratio:

Contrast ratio is calculated with the following formula

$$\text{Contrast ratio (CR)} = \frac{\text{Photo detector output when LCD is at "White" state}}{\text{Photo detector output when LCD is at "Black" state}}$$

Note4: Definition of viewing angle:

Refer to figure as below:

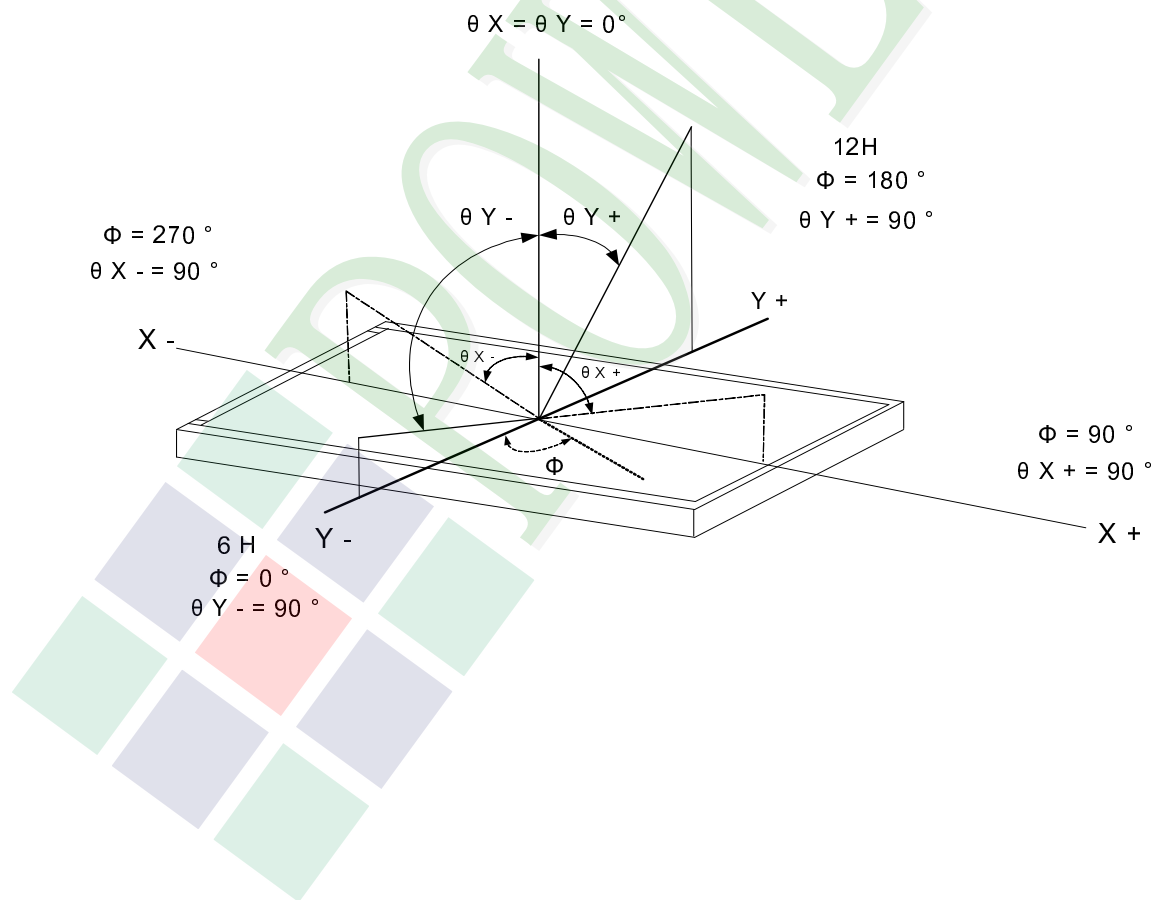

1.6 Backlight Characteristics

Maximum Ratings

Item	Symbol	Min.	Max.	Unit	Remark
LED Forward Current	I_F	35		mA	One LED
LED Reverse Voltage	V_R	10		V	

Electrical / Optical Characteristics

Item	Symbol	Condition	Min.	Typ.	Max.	Unit	Remark
LED Voltage	V_L	$I_L=140\text{mA}$	14.7	18.0	19.2	V	Note1
LED life time	-		50000	-	-	hr	Note2

Note 1: The LED Supply Voltage is defined by the number of LED at $T_a=25\text{ }^\circ\text{C}$.

Note 2: The "LED life time" is defined as the module brightness decrease to 50% original brightness at $T_a=25\text{ }^\circ\text{C}$ and $I_L=140\text{ mA}$. The LED life time could be decreased if operating I_L is larger than 140 mA.

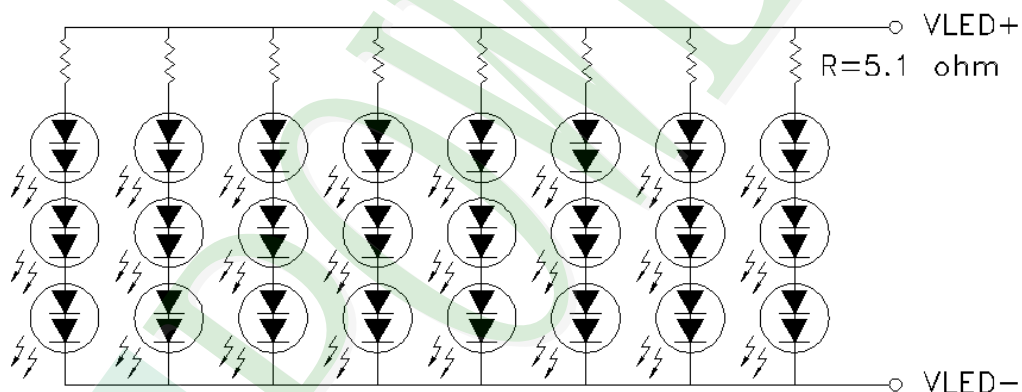

2. MODULE STRUCTURE

2.1 Counter Drawing

2.1.1 LCM Mechanical Diagram

* See Appendix

2.1.2 Block Diagram

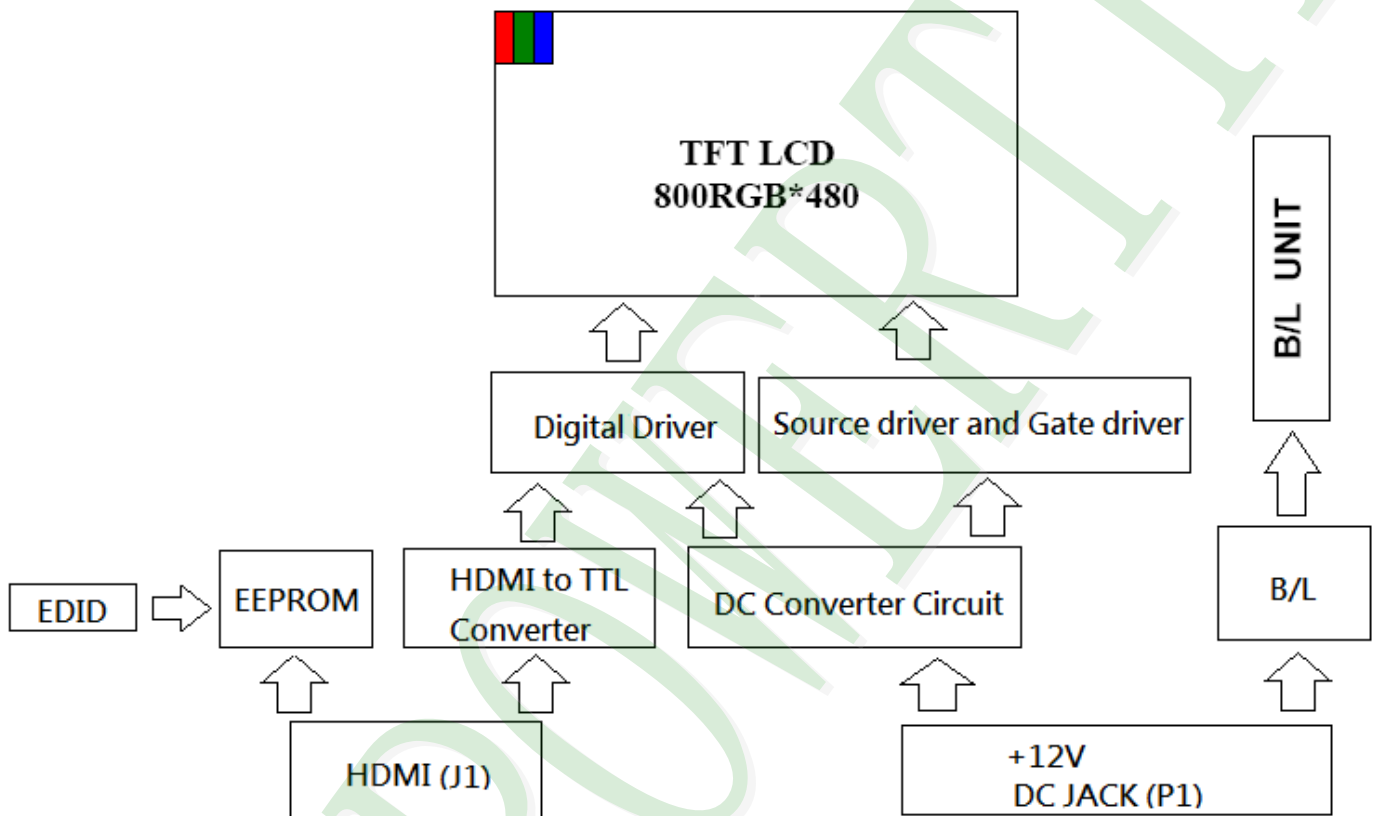

2.2 Interface Pin Description

2.2.1 (J1:HDMI 1.3 A type Interface)

Pin#	Name	Description
1	TX2+	TMDS Data 2+
2	TX2 Shield	TMDS Data 2 Shield
3	TX2-	TMDS Data 2-
4	TX1+	TMDS Data 1+
5	TX1 Shield	TMDS Data 1 Shield
6	TX1-	TMDS Data 1-
7	TX0+	TMDS Data 0+
8	TX0 Shield	TMDS Data 0 Shield
9	TX0-	TMDS Data 0-
10	TXC+	TMDS Clock+
11	TXC Shield	TMDS Clock Shield
12	TXC-	TMDS Clock-
13	CEC	CEC
14	NC	No connection
15	SCL	Serial Clock for DDC
16	SDA	Serial Data for DDC
17	GND	Power ground
18	V5V	+5V Power
19	Hot Plug Detect	Hot Plug Detect

2.2.2 (PJ1:POWER DC JACK Interface)

PJ1

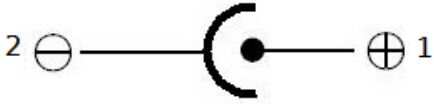

Hold $\Phi 6.4\text{mm}$ / Center Pin $\Phi 2.0\text{mm}$

Pin#	Name	Description
1	V12V	+12V Power
2	GND	Power ground

2.3 HDMI Characteristics

2.3.1 Signal DC&AC Characteristics

DC ELECTRICAL CHARACTERISTICS

over operating free-air temperature range (unless otherwise noted)

PARAMETER	TEST CONDITIONS	MIN	TYP	MAX	UNIT
V _{ID}	Analog input differential voltage ⁽¹⁾	75		1200	mV
V _{IC}	Analog input common-mode voltage ⁽¹⁾	AV _{DD} - 300		AV _{DD} - 37	mV
V _{I(OC)}	Open-circuit analog input voltage	AV _{DD} - 10		AV _{DD} + 10	mV
I _{DD(2PIX)}	Normal 2-pix/clock power supply current ⁽²⁾	ODCK = 82.5 MHz, 2-pix/clock		370	mA
I _{PD}	Power-down current ⁽³⁾	\overline{PD} = low		10	mA
I _{PDO}	Output drive power-down current ⁽³⁾	\overline{PDO} = low		35	mA

(1) Specified as dc characteristic with no overshoot or undershoot

(2) Alternating 2-pixel black/2-pixel white pattern. ST = high, STAG = high, QE[23:0] and QO[23:0] C_L = 10 pF.

(3) Analog inputs are open circuit (transmitter is disconnected from TFP401/401A).

AC ELECTRICAL CHARACTERISTICS

over recommended operating free-air temperature range (unless otherwise noted)

PARAMETER	TEST CONDITIONS	MIN	TYP	MAX	UNIT
V _{ID(2)}	Differential input sensitivity ⁽¹⁾	150		1560	mV _{p-p}
t _{ps}	Analog input intra-pair (+ to -) differential skew ⁽²⁾			0.4	t _{bit} ⁽³⁾
t _{ccs}	Analog input inter-pair or channel-to-channel skew ⁽²⁾			1	t _{pix} ⁽⁴⁾
t _{jit}	Worst-case differential input clock jitter tolerance ⁽²⁾⁽⁵⁾	50			ps
t _{r1}	Fall time of data and control signals ⁽⁶⁾⁽⁷⁾	ST = low, C _L = 5 pF		2.4	ns
		ST = high, C _L = 10 pF		1.9	
t _{r1}	Rise time of data and control signals ⁽⁶⁾⁽⁷⁾	ST = low, C _L = 5 pF		2.4	ns
		ST = high, C _L = 10 pF		1.9	
t _{r2}	Rise time of ODCK clock ⁽⁶⁾	ST = low, C _L = 5 pF		2.4	ns
		ST = high, C _L = 10 pF		1.9	
t _{r2}	Fall time of ODCK clock ⁽⁶⁾	ST = low, C _L = 5 pF		2.4	ns
		ST = high, C _L = 10 pF		1.9	
t _{su1}	Setup time, data and control signal to falling edge of ODCK	1 pixel/clock, PIXS = low, OCK_INV = low	1.8		ns
		2 pixel/clock, PIXS = high, STAG = high, OCK_INV = low	3.8		
		2 pixel and STAG, PIXS = high, STAG = low, OCK_INV = low	0.7		
t _{h1}	Hold time, data and control signal to falling edge of ODCK	1 pixel/clock, PIXS = low, OCK_INV = low	0.6		ns
		2 pixel and STAG, PIXS = high, STAG = low, OCK_INV = low	2.5		
		2 pixel/clock, PIXS = high, STAG = high, OCK_INV = low	2.9		

(1) Specified as ac parameter to include sensitivity to overshoot, undershoot and reflection.

(2) By characterization

(3) t_{bit} is 1/10 the pixel time, t_{pix}

(4) t_{pix} is the pixel time defined as the period of the RxC input clock. The period of ODCK is equal to t_{pix} in 1-pixel/clock mode or 2t_{pix} when in 2-pixel/clock mode.

(5) Measured differentially at 50% crossing using ODCK output clock as trigger

(6) Rise and fall times measured as time between 20% and 80% of signal amplitude.

(7) Data and control signals are QE[23:0], QO[23:0], DE, HSYNC, VSYNC. and CTL[3:1].

AC ELECTRICAL CHARACTERISTICS (continued)

over recommended operating free-air temperature range (unless otherwise noted)

PARAMETER		TEST CONDITIONS	MIN	TYP	MAX	UNIT
t_{su2}	Setup time, data and control signal to rising edge of ODCK	1 pixel/clock, PIXS = low, OCK_INV = high	2.1			ns
		2 pixel/clock, PIXS = high, STAG = high, OCK_INV = high	4			
		2 pixel and STAG, PIXS = high, STAG = low, OCK_INV = high	1.5			
t_{h2}	Hold time, data and control signal to rising edge of ODCK	1 pixel/clock, PIXS = low, OCK_INV = high	0.5			ns
		2 pixel and STAG, PIXS = high, STAG = low, OCK_INV = high	2.4			
		2 pixel/clock, PIXS = high, STAG = high, OCK_INV = high	2.1			
f_{ODCK}	ODCK frequency	PIX = low (1-PIX/CLK)	25		165	MHz
		PIX = high (2-PIX/CLK)	12.5		82.5	
	ODCK duty-cycle		40%	50%	60%	
$t_{pd(PDL)}$	Propagation delay time from \overline{PD} low to Hi-Z outputs				9	ns
$t_{pd(PDOL)}$	Propagation delay time from \overline{PDO} low to Hi-Z outputs				9	ns
$t_{t(HSC)}$	Transition time between DE transition to SCDT low ⁽⁸⁾			1e6		t_{pix}
$t_{t(FSC)}$	Transition time between DE transition to SCDT high ⁽⁸⁾			1600		t_{pix}
$t_{d(st)}$	Delay time, ODCK latching edge to QE[23:0] data output	\overline{STAG} = low, PIXS = high		0.25		t_{pix}

(8) Link active or inactive is determined by amount of time detected between DE transitions. SCDT indicates link activity.

2.3.2 Parameter Measurement Information

PARAMETER MEASUREMENT INFORMATION

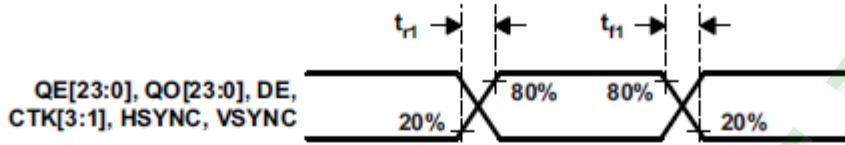

Figure 1. Rise and Fall Times of Data and Control Signals

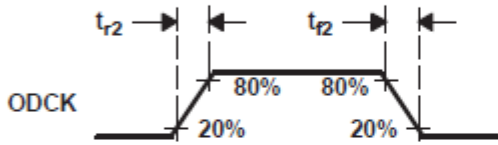

Figure 2. Rise and Fall Times of ODCK

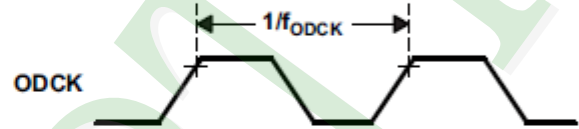

Figure 3. ODCK Frequency

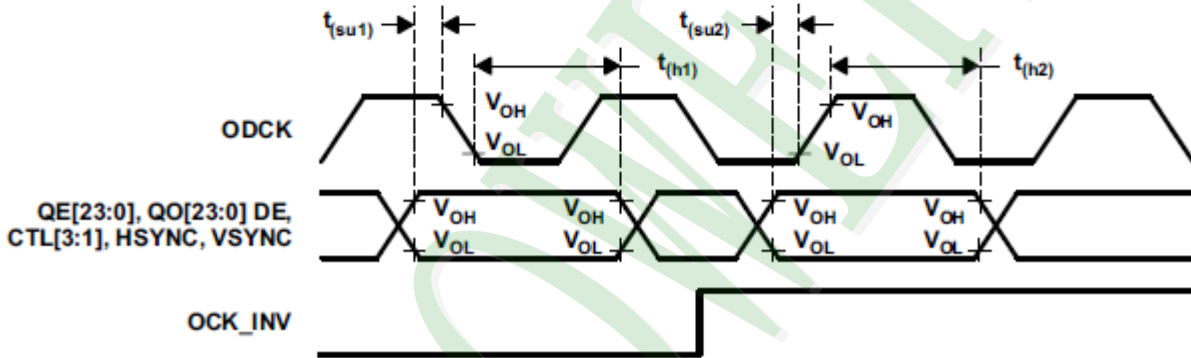

Figure 4. Data Setup and Hold Times to Rising and Falling Edges of ODCK

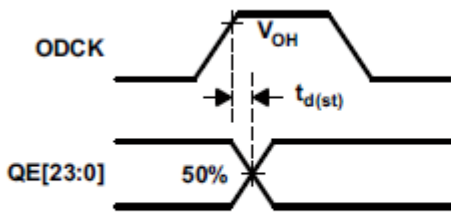

Figure 5. ODCK High to QE[23:0] Staggered Data Output

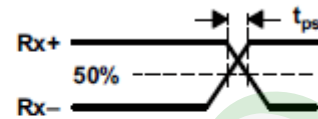

Figure 6. Analog Input Intra-Pair Differential Skew

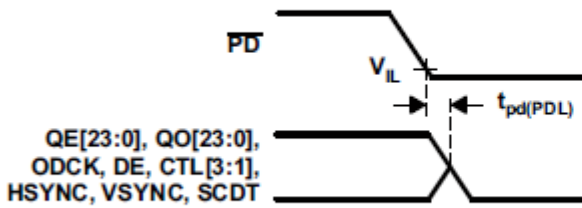

Figure 7. Delay From \overline{PD} Low to Hi-Z Outputs

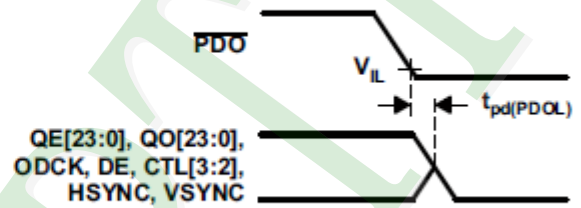

Figure 8. Delay From \overline{PDO} Low to Hi-Z Outputs

PARAMETER MEASUREMENT INFORMATION (continued)

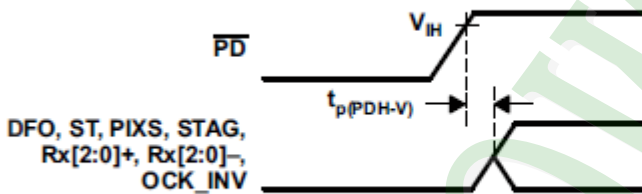

Figure 9. Delay From \overline{PD} Low to High Before Inputs Are Active

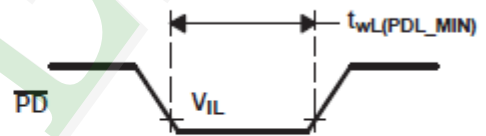

Figure 10. Minimum Time \overline{PD} Low

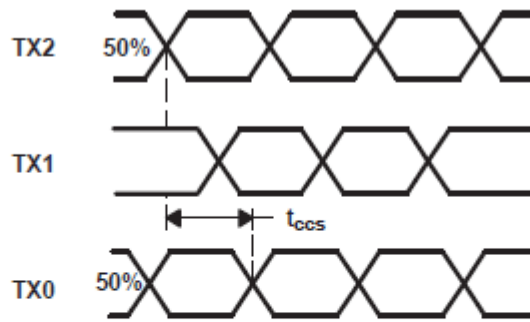

Figure 11. Analog Input Channel-to-Channel Skew

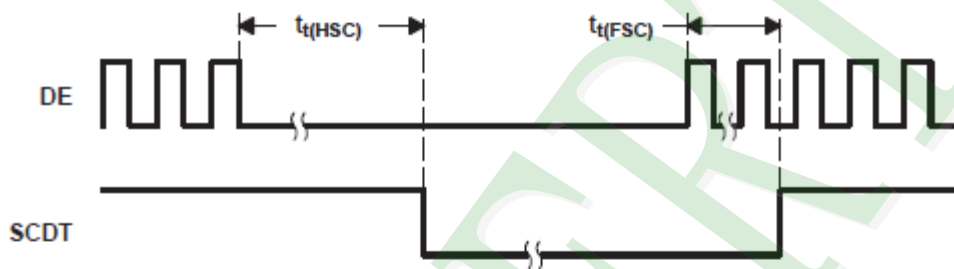

Figure 12. Time Between DE Transitions to SCDT Low and SCDT High

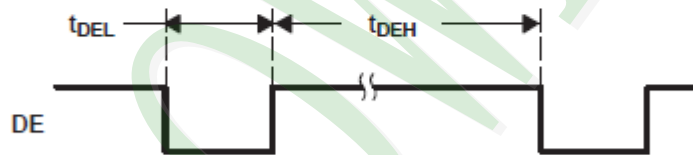

Figure 13. Minimum DE Low and Maximum DE High

DETAILED DESCRIPTION

2.3.3 Power Sequence

POWER ON

a. Power on:

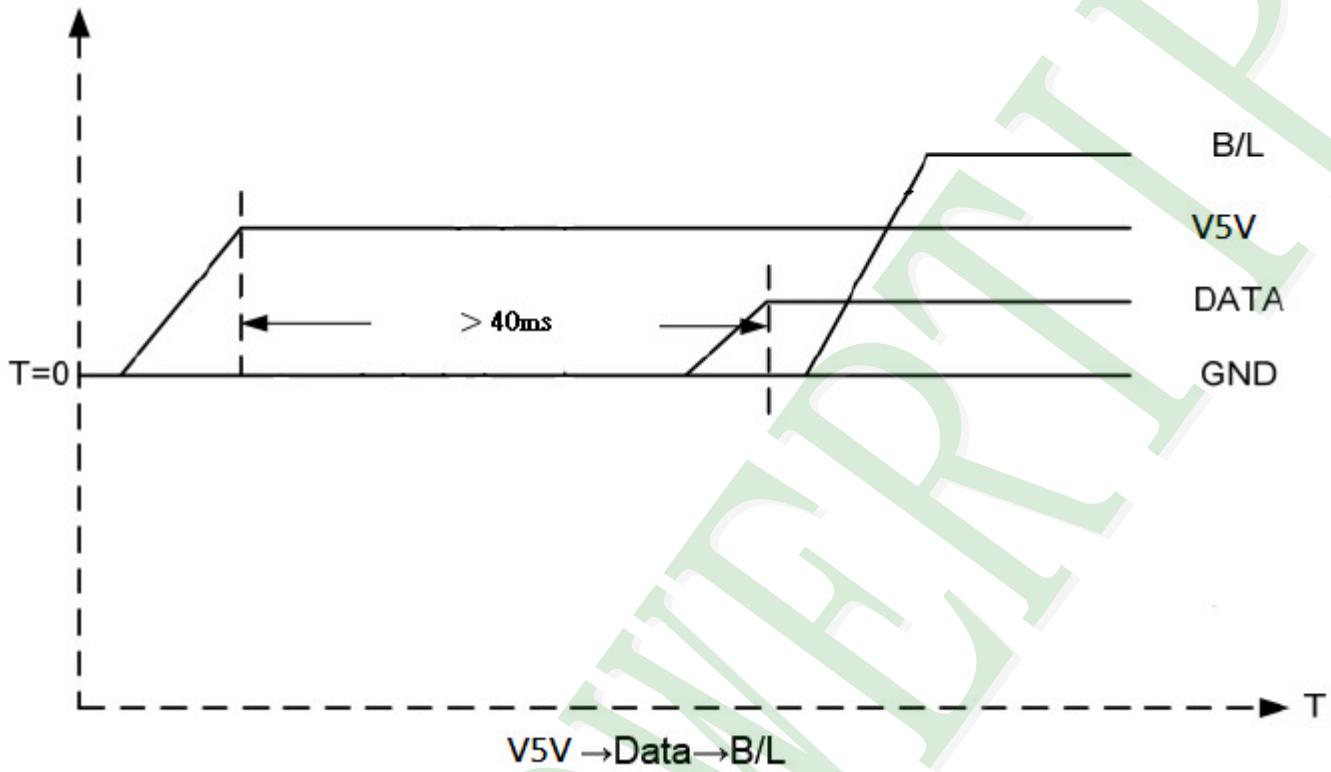

POWER OFF

b. Power off:

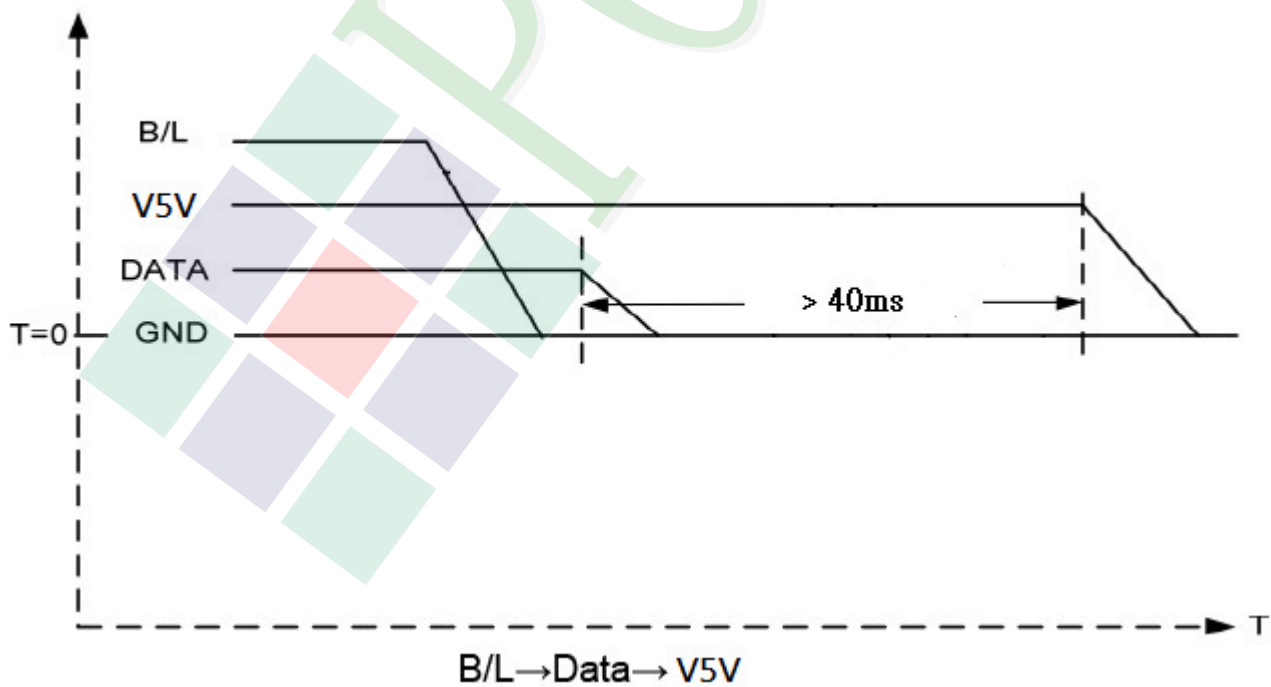

3. QUALITY ASSURANCE SYSTEM

3.1 Quality Assurance Flow Chart

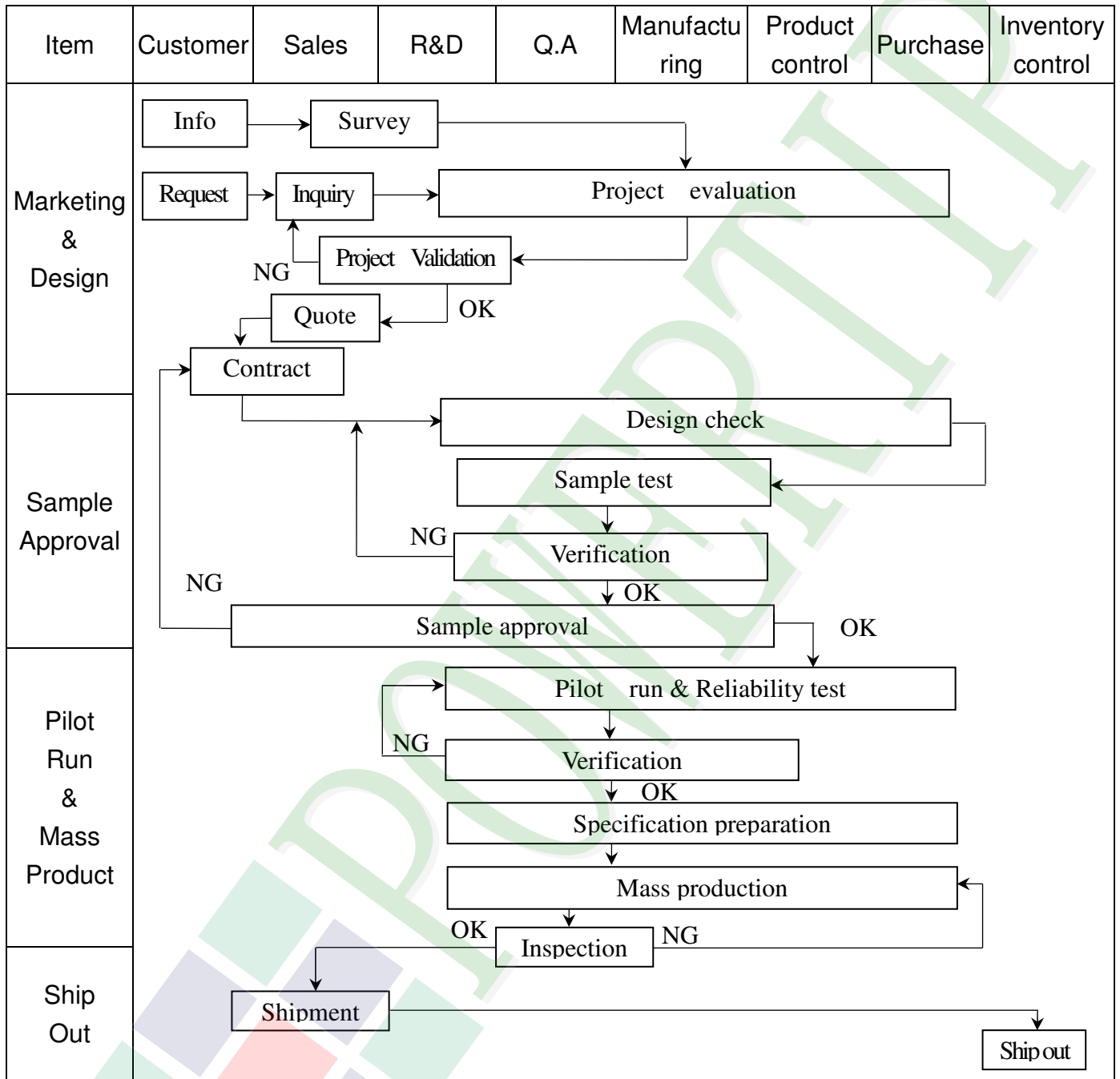

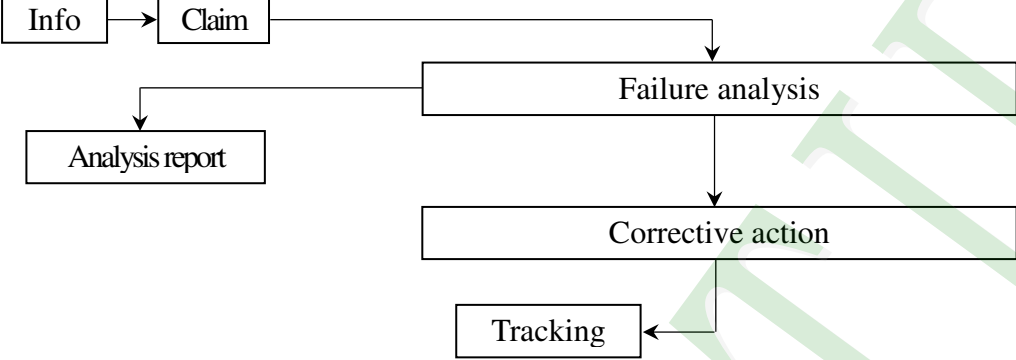
Item	Customer	Sales	R&D	Q.A	Manufacturing	Product control	Purchase	Inventory control
Sales Service	 <pre> graph TD Info[Info] --> Claim[Claim] Claim --> Failure[Failure analysis] Failure --> Report[Analysis report] Failure --> Action[Corrective action] Action --> Tracking[Tracking] </pre>							
Q.A Activity	1. ISO 9001 Maintenance Activities 3. Equipment calibration 5. Standardization Management				2. Process improvement proposal 4. Education And Training Activities			

3.2. Inspection Specification

- ◆Scope : The document shall be applied to TFT-LCD Module for 3.5" ~10" (Ver.B01).
- ◆Inspection Standard : MIL-STD-105E Table Normal Inspection Single Sampling Level II.
- ◆Equipment : Gauge 、 MIL-STD 、 Powertip Tester 、 Sample
- ◆Defect Level : Major Defect AQL : 0.4 ; Minor Defect AQL : 1.5
- ◆OUT Going Defect Level : Sampling.
- ◆Standard of the product appearance test :

a. Manner of appearance test :

- (1). The test best be under 20W×2 fluorescent light , and distance of view must be at 30 cm.
- (2). The test direction is base on about around 45° of vertical line.

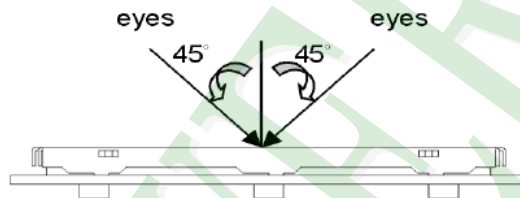

(3). Definition of area.

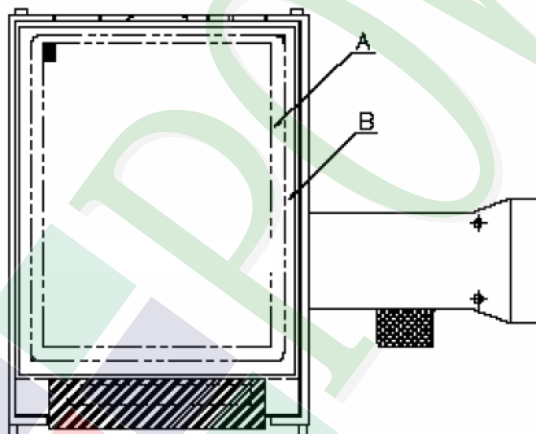

A area : viewing area

B area : Outside of viewing area

(4). Standard of inspection : (Unit : mm)

◆ Specification For TFT-LCD Module 3.5" ~10" :

(Ver.B01)

NO	Item	Criterion	Level										
01	Product condition	1. 1 The part number is inconsistent with work order of production.	Major										
		1. 2 Mixed product types.	Major										
		1. 3 Assembled in inverse direction.	Major										
02	Quantity	2. 1 The quantity is inconsistent with work order of production.	Major										
03	Outline dimension	3. 1 Product dimension and structure must conform to structure diagram.	Major										
04	Electrical Testing	4. 1 Missing line character and icon.	Major										
		4. 2 No function or no display.	Major										
		4. 3 Display malfunction.	Major										
		4. 4 LCD viewing angle defect.	Major										
		4. 5 Current consumption exceeds product specifications.	Major										
05	Dot defect (Bright dot 、 Dark dot) On -display	<table border="1"> <thead> <tr> <th>Item</th> <th>Acceptance (Q'ty)</th> </tr> </thead> <tbody> <tr> <td>Bright Dot</td> <td>≤ 4</td> </tr> <tr> <td>Dark Dot</td> <td>≤ 5</td> </tr> <tr> <td>Joint Dot</td> <td>≤ 3</td> </tr> <tr> <td>Total</td> <td>≤ 7</td> </tr> </tbody> </table>	Item	Acceptance (Q'ty)	Bright Dot	≤ 4	Dark Dot	≤ 5	Joint Dot	≤ 3	Total	≤ 7	Minor
		Item	Acceptance (Q'ty)										
		Bright Dot	≤ 4										
		Dark Dot	≤ 5										
		Joint Dot	≤ 3										
Total	≤ 7												
5. 1 Inspection pattern : full white , full black , Red , Green and blue screens.													
5. 2 It is defined as dot defect if defect area $> 1/2$ dot.													
5. 3 The distance between two dot defect ≥ 5 mm.													

◆ Specification For TFT-LCD Module 3.5" ~10" :

(Ver.B01)

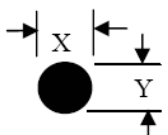
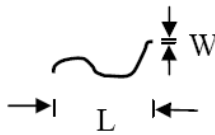
NO	Item	Criterion	Level																																								
06	<p>Black or white dot、scratch、contamination</p> <p>Round type</p>  <p>$\Phi = (x+y) / 2$</p> <p>Line type</p> 	<p>6.1 Round type (Non-display or display) :</p> <table border="1"> <thead> <tr> <th rowspan="2">Dimension (diameter : Φ)</th> <th colspan="2">Acceptance (Q'ty)</th> </tr> <tr> <th>A area</th> <th>B area</th> </tr> </thead> <tbody> <tr> <td>$\Phi \leq 0.25$</td> <td colspan="2">Ignore</td> </tr> <tr> <td>$0.25 < \Phi \leq 0.50$</td> <td>5</td> <td rowspan="3">Ignore</td> </tr> <tr> <td>$\Phi > 0.50$</td> <td>0</td> </tr> <tr> <td>Total</td> <td>5</td> </tr> </tbody> </table> <p>6.2 Line type(Non-display or display) :</p> <table border="1"> <thead> <tr> <th rowspan="2">Length (L)</th> <th rowspan="2">Width (W)</th> <th colspan="2">Acceptance (Q'ty)</th> </tr> <tr> <th>A area</th> <th>B area</th> </tr> </thead> <tbody> <tr> <td>--</td> <td>$W \leq 0.03$</td> <td colspan="2">Ignore</td> </tr> <tr> <td>$L \leq 10.0$</td> <td>$0.03 < W \leq 0.05$</td> <td>4</td> <td rowspan="3">Ignore</td> </tr> <tr> <td>$L \leq 5.0$</td> <td>$0.05 < W \leq 0.10$</td> <td>2</td> </tr> <tr> <td>--</td> <td>$W > 0.10$</td> <td colspan="2">As round type</td> </tr> <tr> <td colspan="2">Total</td> <td>5</td> <td></td> </tr> </tbody> </table>	Dimension (diameter : Φ)	Acceptance (Q'ty)		A area	B area	$\Phi \leq 0.25$	Ignore		$0.25 < \Phi \leq 0.50$	5	Ignore	$\Phi > 0.50$	0	Total	5	Length (L)	Width (W)	Acceptance (Q'ty)		A area	B area	--	$W \leq 0.03$	Ignore		$L \leq 10.0$	$0.03 < W \leq 0.05$	4	Ignore	$L \leq 5.0$	$0.05 < W \leq 0.10$	2	--	$W > 0.10$	As round type		Total		5		Minor
Dimension (diameter : Φ)	Acceptance (Q'ty)																																										
	A area	B area																																									
$\Phi \leq 0.25$	Ignore																																										
$0.25 < \Phi \leq 0.50$	5	Ignore																																									
$\Phi > 0.50$	0																																										
Total	5																																										
Length (L)	Width (W)	Acceptance (Q'ty)																																									
		A area	B area																																								
--	$W \leq 0.03$	Ignore																																									
$L \leq 10.0$	$0.03 < W \leq 0.05$	4	Ignore																																								
$L \leq 5.0$	$0.05 < W \leq 0.10$	2																																									
--	$W > 0.10$	As round type																																									
Total		5																																									
07	<p>Polarizer Bubble</p>	<table border="1"> <thead> <tr> <th rowspan="2">Dimension (diameter : Φ)</th> <th colspan="2">Acceptance (Q'ty)</th> </tr> <tr> <th>A area</th> <th>B area</th> </tr> </thead> <tbody> <tr> <td>$\Phi \leq 0.25$</td> <td colspan="2">Ignore</td> </tr> <tr> <td>$0.25 < \Phi \leq 0.50$</td> <td>4</td> <td rowspan="3">Ignore</td> </tr> <tr> <td>$0.50 < \Phi \leq 0.80$</td> <td>1</td> </tr> <tr> <td>$\Phi > 0.80$</td> <td>0</td> </tr> <tr> <td>Total</td> <td>5</td> <td></td> </tr> </tbody> </table>	Dimension (diameter : Φ)	Acceptance (Q'ty)		A area	B area	$\Phi \leq 0.25$	Ignore		$0.25 < \Phi \leq 0.50$	4	Ignore	$0.50 < \Phi \leq 0.80$	1	$\Phi > 0.80$	0	Total	5		Minor																						
Dimension (diameter : Φ)	Acceptance (Q'ty)																																										
	A area	B area																																									
$\Phi \leq 0.25$	Ignore																																										
$0.25 < \Phi \leq 0.50$	4	Ignore																																									
$0.50 < \Phi \leq 0.80$	1																																										
$\Phi > 0.80$	0																																										
Total	5																																										

◆ Specification For TFT-LCD Module 3.5" ~10" :

(Ver.B01)

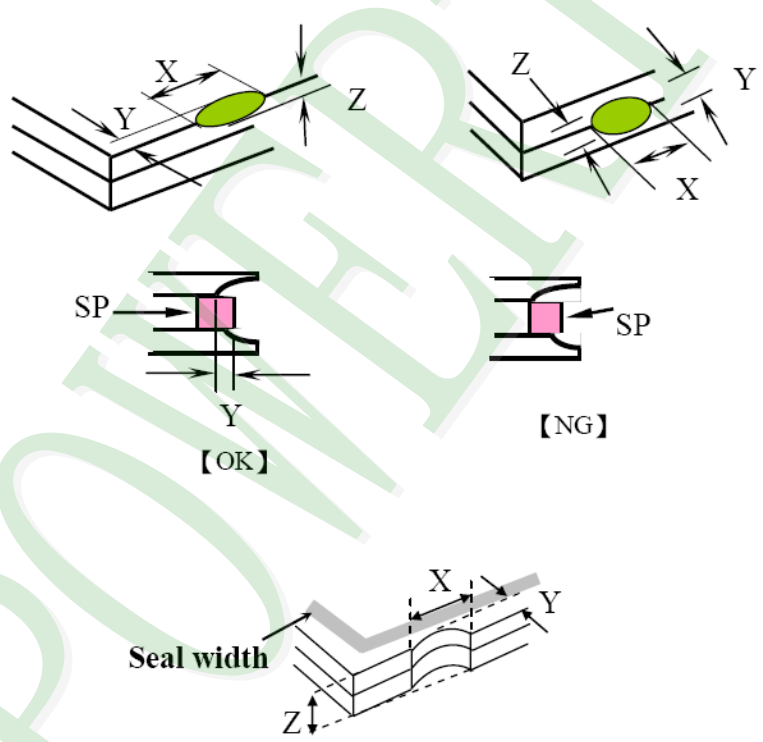
NO	Item	Criterion	Level									
08	The crack of glass	<p>Symbols :</p> <p>X : The length of crack Z : The thickness of crack t : The thickness of glass</p> <p>Y : The width of crack. W : terminal length a : LCD side length</p> <hr/> <p>8.1 General glass chip : 8.1.1 Chip on panel surface and crack between panels:</p>  <table border="1" data-bbox="542 1545 1340 1836"> <thead> <tr> <th>X</th> <th>Y</th> <th>Z</th> </tr> </thead> <tbody> <tr> <td>$\leq a$</td> <td>Crack can't enter viewing area</td> <td>$\leq 1/2 t$</td> </tr> <tr> <td>$\leq a$</td> <td>Crack can't exceed the half of SP width.</td> <td>$1/2 t < Z \leq 2 t$</td> </tr> </tbody> </table>	X	Y	Z	$\leq a$	Crack can't enter viewing area	$\leq 1/2 t$	$\leq a$	Crack can't exceed the half of SP width.	$1/2 t < Z \leq 2 t$	Minor
X	Y	Z										
$\leq a$	Crack can't enter viewing area	$\leq 1/2 t$										
$\leq a$	Crack can't exceed the half of SP width.	$1/2 t < Z \leq 2 t$										

◆ Specification For TFT-LCD Module 3.5" ~10" :

(Ver.B01)

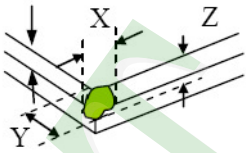
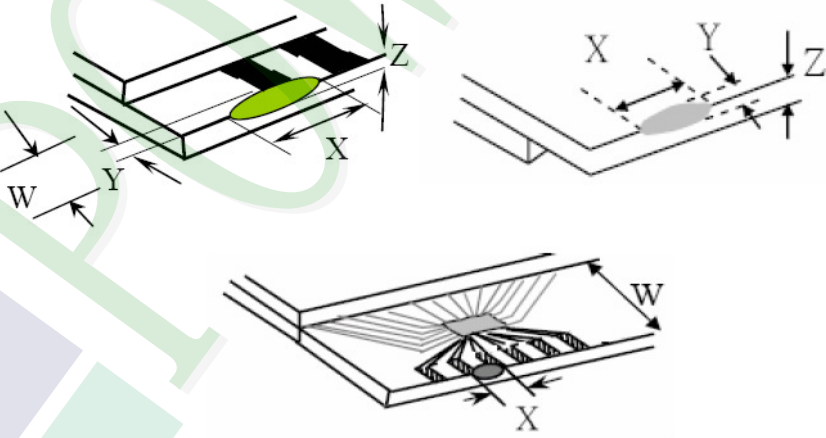
NO	Item	Criterion	Level												
08	The crack of glass	<p>Symbols :</p> <p>X : The length of crack Z : The thickness of crack t : The thickness of glass</p> <p>Y : The width of crack. W : terminal length a : LCD side length</p> <hr/> <p>8.1.2 Corner crack :</p>  <table border="1" data-bbox="525 757 1334 1048"> <thead> <tr> <th>X</th> <th>Y</th> <th>Z</th> </tr> </thead> <tbody> <tr> <td>$\leq 1/5 a$</td> <td>Crack can't enter viewing area</td> <td>$Z \leq 1/2 t$</td> </tr> <tr> <td>$\leq 1/5 a$</td> <td>Crack can't exceed the half of SP width.</td> <td>$1/2 t < Z \leq 2 t$</td> </tr> </tbody> </table>	X	Y	Z	$\leq 1/5 a$	Crack can't enter viewing area	$Z \leq 1/2 t$	$\leq 1/5 a$	Crack can't exceed the half of SP width.	$1/2 t < Z \leq 2 t$				
		X	Y	Z											
$\leq 1/5 a$	Crack can't enter viewing area	$Z \leq 1/2 t$													
$\leq 1/5 a$	Crack can't exceed the half of SP width.	$1/2 t < Z \leq 2 t$													
		<p>8.2 Protrusion over terminal :</p> <p>8.2.1 Chip on electrode pad :</p>  <table border="1" data-bbox="563 1680 1343 1850"> <thead> <tr> <th></th> <th>X</th> <th>Y</th> <th>Z</th> </tr> </thead> <tbody> <tr> <td>Front</td> <td>$\leq a$</td> <td>$\leq 1/2 W$</td> <td>$\leq t$</td> </tr> <tr> <td>Back</td> <td>$\leq a$</td> <td>$\leq W$</td> <td>$\leq 1/2 t$</td> </tr> </tbody> </table>		X	Y	Z	Front	$\leq a$	$\leq 1/2 W$	$\leq t$	Back	$\leq a$	$\leq W$	$\leq 1/2 t$	Minor
	X	Y	Z												
Front	$\leq a$	$\leq 1/2 W$	$\leq t$												
Back	$\leq a$	$\leq W$	$\leq 1/2 t$												

◆ Specification For TFT-LCD Module 3.5" ~10" :

(Ver.B01)

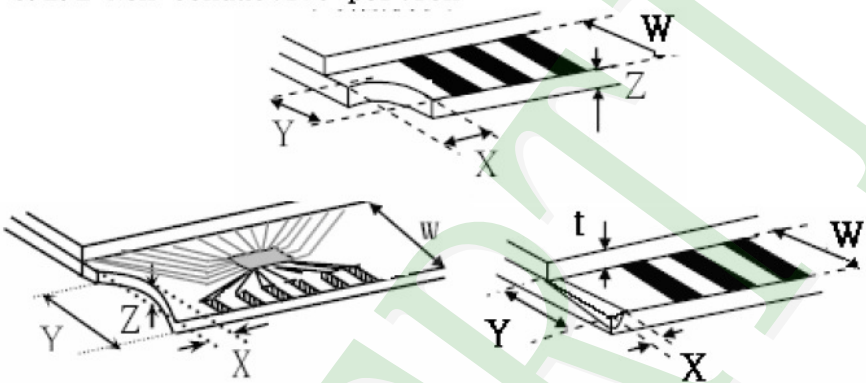
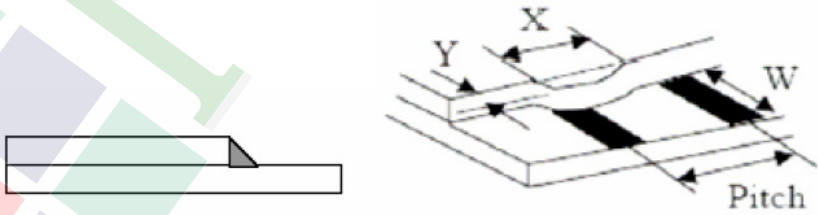
NO	Item	Criterion	Level												
08	The crack of glass	<p>Symbols :</p> <p>X : The length of crack Y : The width of crack. Z : The thickness of crack W : terminal length t : The thickness of glass a : LCD side length</p> <hr/> <p>8.2.2 Non-conductive portion :</p>  <table border="1" data-bbox="630 963 1260 1120"> <thead> <tr> <th>X</th> <th>Y</th> <th>Z</th> </tr> </thead> <tbody> <tr> <td>$\leq 1/3 a$</td> <td>$\leq W$</td> <td>$\leq t$</td> </tr> </tbody> </table> <p>⊙ If the chipped area touches the ITO terminal, over 2/3 of the ITO must remain and be inspected according to electrode terminal specifications.</p> <p>8.2.3 Glass remain :</p>  <table border="1" data-bbox="550 1736 1244 1881"> <thead> <tr> <th>X</th> <th>Y</th> <th>Z</th> </tr> </thead> <tbody> <tr> <td>$\leq a$</td> <td>$\leq 1/3 W$</td> <td>$\leq t$</td> </tr> </tbody> </table>	X	Y	Z	$\leq 1/3 a$	$\leq W$	$\leq t$	X	Y	Z	$\leq a$	$\leq 1/3 W$	$\leq t$	Minor
		X	Y	Z											
$\leq 1/3 a$	$\leq W$	$\leq t$													
X	Y	Z													
$\leq a$	$\leq 1/3 W$	$\leq t$													

5. PRECAUTION RELATING PRODUCT HANDLING

5.1 SAFETY

- 5.1.1 If the LCD panel breaks , be careful not to get the liquid crystal to touch your skin.
- 5.1.2 If the liquid crystal touches your skin or clothes , please wash it off immediately by using soap and water.

5.2 HANDLING

- 5.2.1 Avoid any strong mechanical shock which can break the glass.
- 5.2.2 Avoid static electricity which can damage the CMOS LSI—When working with the module , be sure to ground your body and any electrical equipment you may be using.
- 5.2.3 Do not remove the panel or frame from the module.
- 5.2.4 The polarizing plate of the display is very fragile. So , please handle it very carefully ,do not touch , push or rub the exposed polarizing with anything harder than an HB pencil lead (glass , tweezers , etc.)
- 5.2.5 Do not wipe the polarizing plate with a dry cloth , as it may easily scratch the surface of plate.
- 5.2.6 Do not touch the display area with bare hands , this will stain the display area.
- 5.2.7 Do not use ketonics solvent & aromatic solvent. Use with a soft cloth soaked with a cleaning naphtha solvent.
- 5.2.8 To control temperature and time of soldering is $320\pm 10^{\circ}\text{C}$ and 3-5 sec.
- 5.2.9 To avoid liquid (include organic solvent) stained on LCM .

5.3 STORAGE

- 5.3.1 Store the panel or module in a dark place where the temperature is $25^{\circ}\text{C} \pm 5^{\circ}\text{C}$ and the humidity is below 65% RH.
- 5.3.2 Do not place the module near organics solvents or corrosive gases.
- 5.3.3 Do not crush , shake , or jolt the module.

5.4 TERMS OF WARRANTY

- 5.4.1 Applicable warrant period
The period is within thirteen months since the date of shipping out under normal using and storage conditions.
- 5.4.2 Unaccepted responsibility
This product has been manufactured to your company's specification as a part for use in your company's general electronic products. It is guaranteed to perform according to delivery specifications. For any other use apart from general electronic equipment , we cannot take responsibility if the product is used in nuclear power control equipment , aerospace equipment , fire and security systems or any other applications in which there is a direct risk to human life and where extremely high levels of reliability are required.

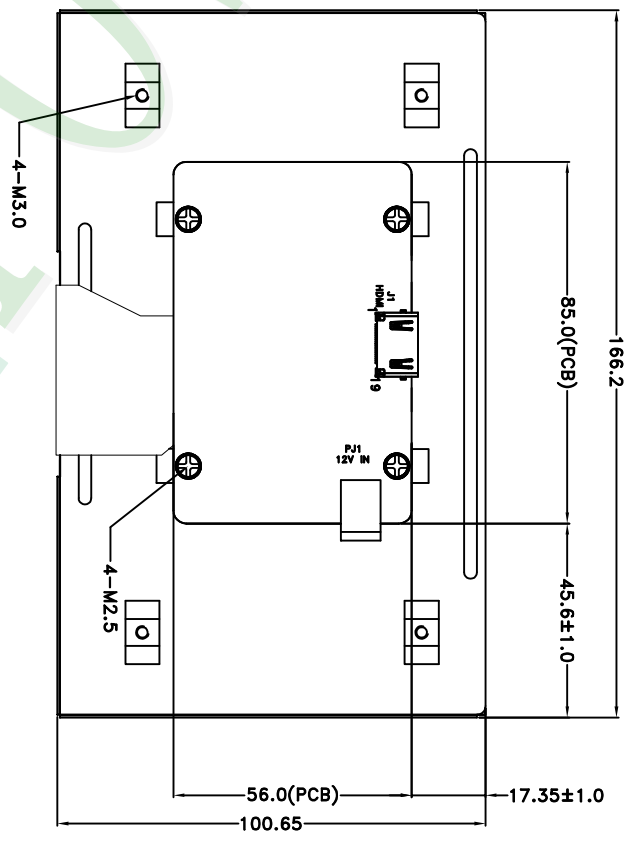
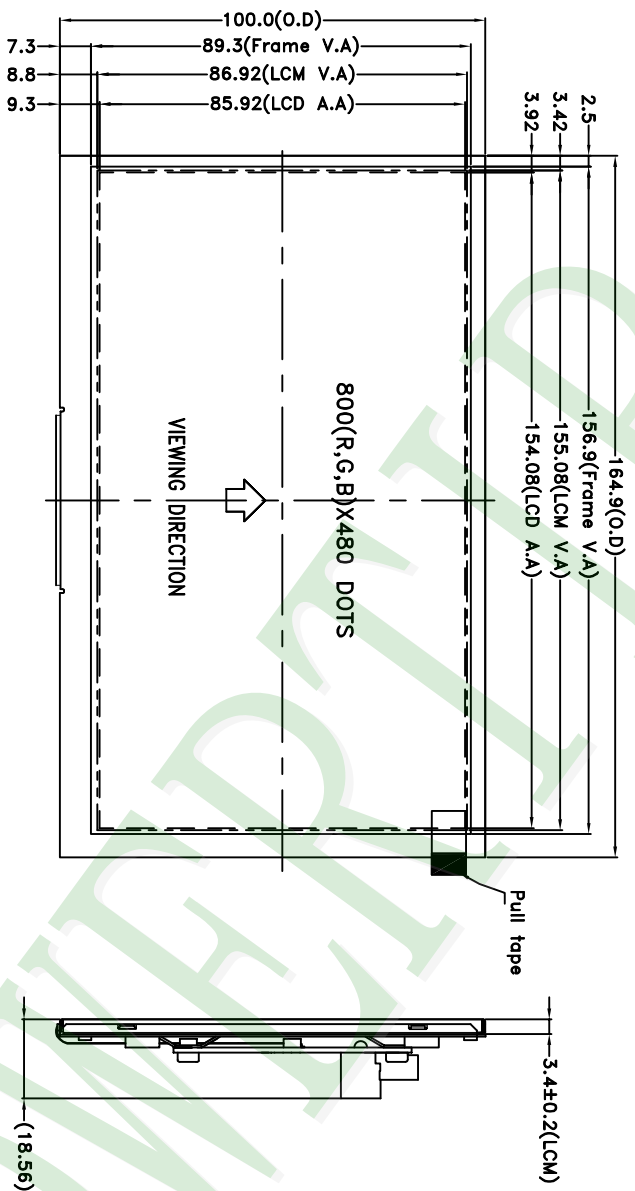

NOTES:
 1.LCD TYPE: TFT LCD
 2.LCD DISPLAY: POSITIVE/TRANSMISSIVE
 3.The tolerance unless classified $\pm 0.3\text{mm}$
 4.J1 : mollex SD-47151-001 OR EQUIVALENT
 5.P11 : KD-014-(DC JACK2.0mm ROHS) OR EQUIVALENT.

007			
006			
005			
004			
003			
002			
001	NEW DRAWING	Kevin	2017/05/16
REV	REV BY	REVISER	DATE

PART NO:	PH800480T013-IHA06
DRAWING NAME:	LMD-PH800480T013-IHA06
TITLE:	LCD MODULE DRAWING

Design		Kevin	久正光电股份有限公司 POWER TIP TECHNOLOGY CORPORATION	Surface	Material	Thickness	Quantity	Precision Level
Check	Approve	Stone						
Unit	MM	(3)						
Scale	1:1							
Page	1/1							
Length (mm)	1 ~ 4							
Width (mm)	4 ~ 16							
Thickness (mm)	16 ~ 63							
	63 ~ 250							
	250 ~ 1000							

LCM包裝規格書

LCM Packaging Specifications

Documents NO. PKG-PH800480T013-IHA06

Approve	Check	Contact
Oliver	Stone	Kevin

1. 包裝材料規格表 (Packaging Material) : (per carton)

No.	Item	Model	Dimensions (mm)	1Pcs Weight	Quantity	Total Weight
1	成品 (LCM)	PH800480T013-IHA06	164.9 X 100.0	0.205	14	2.87
2	抗靜電氣泡袋(1)Bubble Bag	BAG200160BRABA	200X 160	0.0096	14	0.1344
3	A6隔板(2)A6 Partition	BX33800012BZBA	338 X 125 X 3	0.038	16	0.608
4	B6隔板(3)B6 Partition	BX29800012BZBA	298 X 125 X 3	0.023	4	0.092
5	海綿墊(4)Foam Rubber Cushion	OTFOAM00005ABA	330 X 290 X 10	0.025	4	0.1
6	舒美墊(5)EPE	OTFOAMT0006ABA	218 X 125 X 20	0.012	4	0.048
7	C4內盒(6)Product Box	BX36031014AABA	360 X 310 X 142	0.406	2	0.812
8	外紙箱(8)Carton	BX39432432CCBA	394 X 324 X 321	0.884	1	0.884
9						

2. 一 整箱總重量 (Total LCD Weight in carton) : 5.55 Kg±10%

3. 單箱數量規格表 (Packaging Specifications and Quantity) :

(1)Quantity Of Spacer : A6隔板 X 8 , B6隔板 X 2

(2)Total LCM quantity in carton : quantity per box 7 x no of boxes 2 = 14

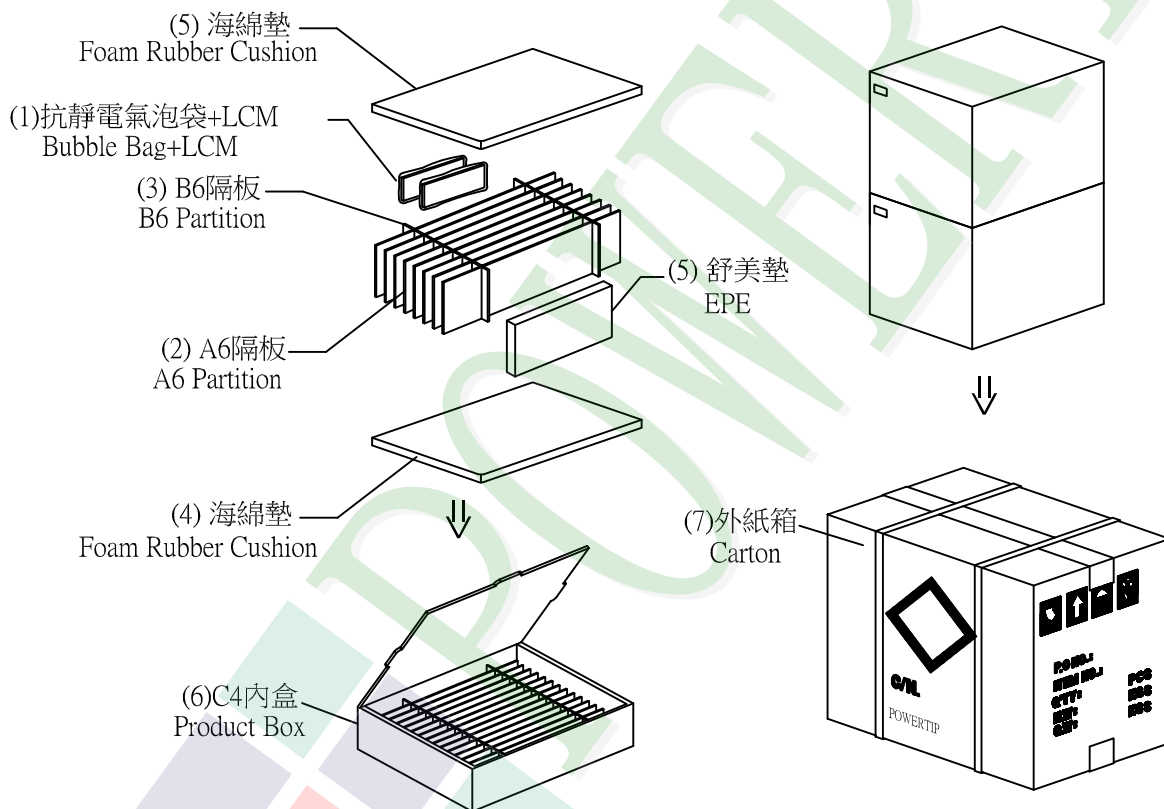

特 記 事 項 (REMARK)

4. Label Specifications :

TYPE			
ID.NO		S/O	
Q'TY	Pcs	Date	
Lot.NO			
Note			

參照"成品包裝點檢作業標準書"內容

5. 每個間隔放1片模組，前後間隔不放置模組。(如示意圖)

5. 1 LCM are placed on every other slot of the divider.

Note: First and last slot should be empty.
(See remarks 6 on packaging specifications)

6. 放置格示意圖:

6. Each divider is placed inside a product Box

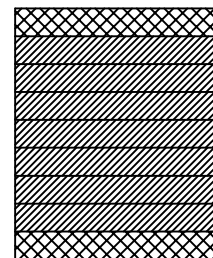

▨ 模組(LCM) X 1pcs.

⊠ 舒美墊(EPE)