



SPECIFICATIONS

CUSTOMER	:	_____
SAMPLE CODE	:	SH720128T004-ZBC11
MASS PRODUCTION CODE	:	PH720128T004-ZBC11
SAMPLE VERSION	:	01
SPECIFICATIONS EDITION	:	002
DRAWING NO. (Ver.)	:	LMD-PH720128T004-ZBC11 (Ver.001)
PACKAGING NO. (Ver.)	:	PKG-PH720128T004-ZBC11(Ver.001)

Customer Approved

Date: _____

Approved	Checked	Designer
廖志豪 Rex Liao	陳宗淇 Howard Chen	張慶源 Yuan Chang

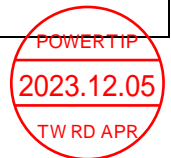

- Preliminary specification for design input
- Specification for sample approval

POWERTIP TECH. CORP.

Headquarters:

No.8, 6th Road, Taichung Industrial Park,
Taichung, Taiwan
台中市 407 工業區六路 8 號

TEL: 886-4-2355-8168
FAX: 886-4-2355-8166

E-mail: sales@powertip.com.tw
[Http://www.powertip.com.tw](http://www.powertip.com.tw)

History of Version

Date (mm / dd / yyyy)	Ver.	Edi.	Description	Page	Design by
04/26/2021	01	001	New Sample	-	Yuan
12/04/2023	01	002	Modify Inspection Specification	31~37	Yuan

Contents

1. SPECIFICATIONS

- 1.1 Features
- 1.2 Mechanical Specifications
- 1.3 Absolute Maximum Ratings
- 1.4 DC Electrical Characteristics
- 1.5 Optical Characteristics
- 1.6 Backlight Characteristics
- 1.7 Touch Panel Characteristics

2. MODULE STRUCTURE

- 2.1 Counter Drawing
- 2.2 Interface Pin Description
- 2.3 AC Electrical Characteristics
- 2.4 Refer Initial Code

3. QUALITY ASSURANCE SYSTEM

- 3.1 Quality Assurance Flow Chart
- 3.2 Inspection Specification

4. RELIABILITY TEST

- 4.1 Reliability Test Condition

5. PRECAUTION RELATING PRODUCT HANDLING

- 5.1 Safety
- 5.2 Handling
- 5.3 Storage
- 5.4 Terms of Warranty

Appendix :

- 1.LCM Drawing
- 2. LCM Packaging Specifications

1. SPECIFICATIONS

1.1 Features

Item	Standard Value
Display Type	720 * (RGB) * 1280
LCD Type	Full Viewing Angle , Normally Black , Transmissive type
Touch panel	True Multi-Touch Capacitive Touch Panel True Multi-touch with up to 5 Points of Absolution
Screen size(inch)	5.0 inch
Backlight Type	LED B/L
Weight	91g
Control IC	ILI9881C
Interface	MIPI Interface
ROHS	THIS PRODUCT CONFORMS THE ROHS OF PTC Detail information please refer website : http://www.powertip.com.tw/news_detail.php?Key=1&clD=1

1.2 Mechanical Specifications

Item	Standard Value	Unit
Outline Dimension	91.46 (W) * 143.4 (L) * 5.22 (H)	mm
Viewing Area	63.1 (W) * 111.4 (L)	mm
Active Area	62.1 (W) * 110.4 (L)	mm

Note : For detailed information please refer to LCM drawing

1.3 Absolute Maximum Ratings

Item	Symbol	Condition	Min.	Max.	Unit	Remark
Supply Voltage	VDD	GND=0	-0.3	+3.8	V	-
Supply Voltage	VCI	GND=0	-0.3	+7.0	V	
Operating Temperature	T _{OP} (Ts)	Note 1	-20	+70	°C	
Storage Temperature	T _{ST} (Ta)	Note 2	-30	+80	°C	

The absolute maximum rating values of this product are not allowed to be exceeded at any times. Should a module be used with any of the absolute maximum ratings exceeded, the characteristics of the module may not be recovered, or in an extreme case, the module may be permanently destroyed.

Note 1 : Ts is the temperature of panel's surface.

Note 2 : Ta is the ambient temperature of samples

1.4 DC Electrical Characteristics

GND = 0V, Ta = 25°C

Item	Symbol	Min.	Typ.	Max.	Unit	Remark
Supply Voltage	VDD	3.0	3.3	3.6	V	-
Supply Voltage	VCI	3.0	3.3	3.6		
Input signal Voltage (I2C Interface)	V _{IH}	0.7*VDD	-	VDD		
	V _{IL}	-0.3	-	0.3*VDD		
	V _{OH}	0.8*VDD	-	VDD		
	V _{OL}	0	-	0.2*VDD		
Supply Current	I _{VDD}	-	20	35	mA	Note1
	I _{VCI}	-	40	60	mA	

Note1: Maximum current display.

1.5 Optical Characteristics

VDD =VCI= 3.3 V, Ta=25°C

Item	Symbol	Condition	Min.	Typ.	Max.	unit		
Response time	Tr +Tf	Ta = 25°C θX, θY = 0°	-	35	40	ms	Note 2	
Viewing angle	Top	θY+	CR ≥ 10	-	80	-	Deg.	Note 4
	Bottom	θY-		-	80	-		
	Left	θX-		-	80	-		
	Right	θX+		-	80	-		
Contrast ratio	CR		650	800	-		Note 3	
Color of CIE Coordinate (With B/L & touch panel)	White	X	Ta = 25°C θX , θY = 0°	0.26	0.31	0.36	-	Note1
		Y		0.31	0.36	0.41		
	Red	X		0.61	0.66	0.71		
		Y		0.27	0.32	0.37		
	Green	X		0.27	0.32	0.37		
		Y		0.57	0.62	0.67		
	Blue	X		0.09	0.14	0.19		
		Y		0.00	0.04	0.09		
Average Brightness Pattern=white display (With B/L & touch panel) *1	IV	IF=40mA	430	500	-	cd/m ²	Note1	
Uniformity (With B/L & touch panel) *2	ΔB		70	-	-	%	Note1	

Note 1:

*1 : $\Delta B = B(\min) / B(\max) * 100\%$

*2 : Measurement Condition for Optical Characteristics:

a : Environment: $25^{\circ}\text{C} \pm 5^{\circ}\text{C}$ / $60 \pm 20\% \text{R.H}$, no wind , dark room below 10 Lux at typical lamp current and typical operating frequency.

b : Measurement Distance: $500 \pm 50 \text{ mm}$, ($\theta = 0^{\circ}$)

c : Equipment: TOPCON BM-7 fast , (field 1°) , after 10 minutes operation.

d : The uncertainty of the C.I.E coordinate measurement ± 0.01 , Average Brightness $\pm 4\%$

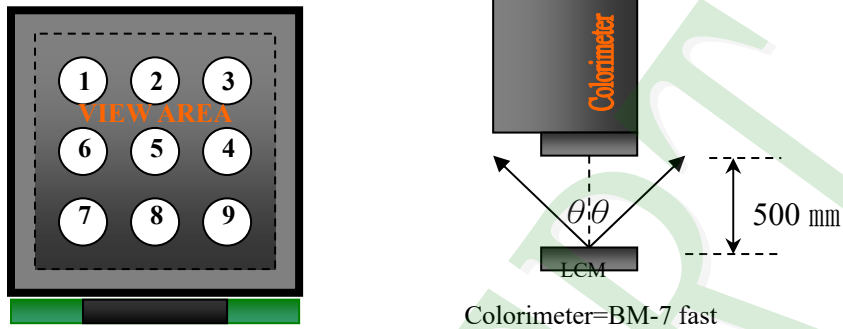

To be measured at the center area of panel with a viewing cone of 1° by Topcon luminance meter BM-7, after 10 minutes operation (module)

Note2: Definition of response time:

The output signals of photo detector are measured when the input signals are changed from "black" to "white"(falling time) and from "white" to "black"(rising time), respectively. The response time is defined as the time interval between the 10% and 90% of Amplitudes.

Refer to figure as below:

Normally White



Normally Black

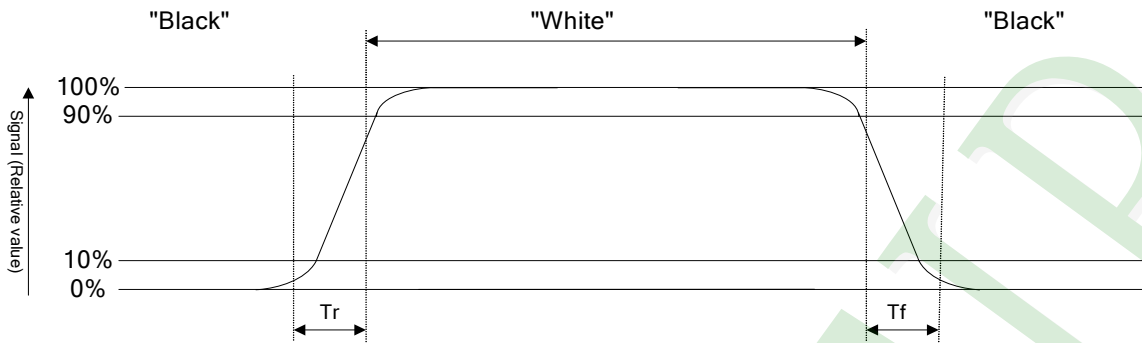

Note3: Definition of contrast ratio:

Contrast ratio is calculated with the following formula

$$\text{Contrast ratio (CR)} = \frac{\text{Photo detector output when LCD is at "White" state}}{\text{Photo detector output when LCD is at "Black" state}}$$

Note4: Definition of viewing angle:

Refer to figure as below:

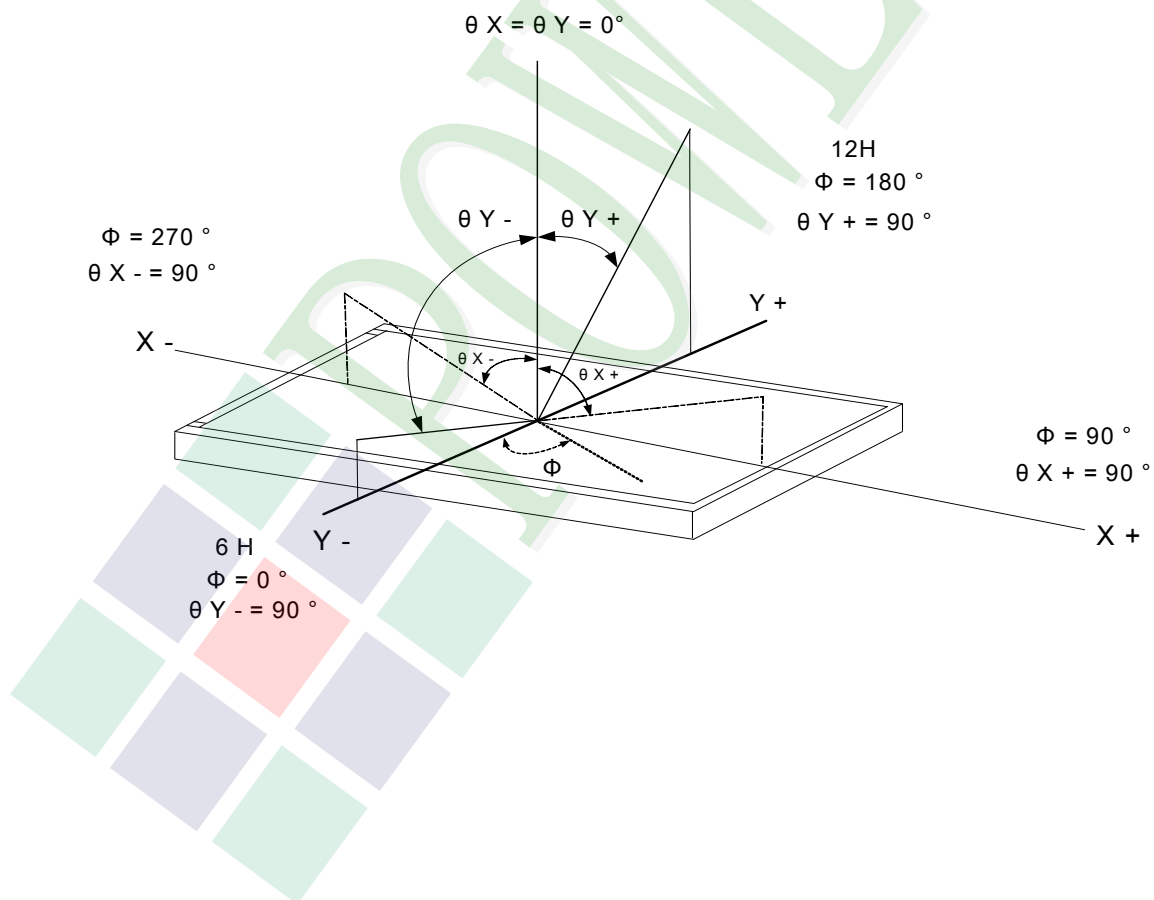

1.6 Backlight Characteristics

Maximum Ratings

Item	Symbol	Conditions	Min.	Max.	Unit
LED Forward Current	IF	Ta =25°C	-	60	mA
LED Reverse Voltage	VR	Ta =25°C	-	5	V
Power Dissipation	PD	Ta =25°C	-	1120	mW

Backlight Characteristics

Item	Symbol	Conditions	Min.	Typ.	Max.	Unit
Forward Voltage	VF	IF= 40 mA	21.6	24.8	28.0	V
Average Brightness (Without LCD)	IV		12000	14500	16500	cd/m ²
CIE Color Coordinate (Without LCD)	X		0.27	0.30	0.33	-
	Y		0.27	0.30	0.33	
Uniformity *1	△B		80	-	-	*2
Color		White				

*1 : This value will be changed while mass production.

*2 : $\Delta B = B(\min) / B(\max)\%$

B/L Internal Circuit Diagram

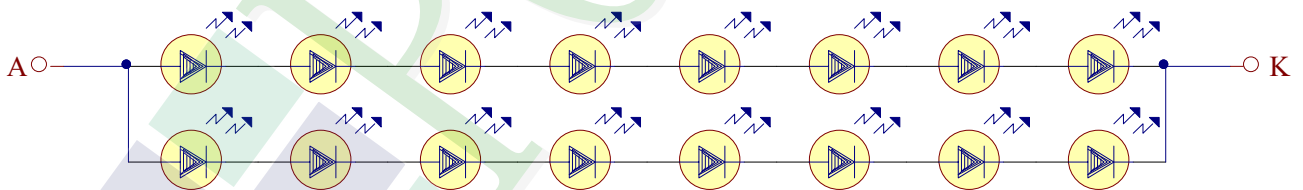

Other Description

Item	Conditions	Description
Life Time	Ta =25°C IF=40 mA	20000 hrs

1.7 Touch Panel Characteristics

Features

Item	Standard Value
Touch Panel Size	5"
Touch type	Projective capacitive touch panel
Input Method	True Multi-touch with up to 5 Points of Absolution X and Y Coordinates
Output Interface	I ² C
IC	Goodix GT911

I²C Address

Bit 7	Bit 6	Bit 5	Bit 4	Bit 3	Bit 2	Bit 1	Bit 0
1	0	1	1	1	0	1	R/W

Bit 0: 0 for Write / 1 for Read

Mechanical Specifications

Item	Standard Value	Unit
Outline Dimension	91.46 (W) * 143.4(L)	-

Absolute Maximum Ratings

Item	Symbol	Condition	Min.	Max.	Unit
Supply voltage	TPVDD	-	1.7	3.47	V
Operating Temperature	T _{OP}	Non condensing	-20	70	°C
Storage Temperature	T _{ST}	Non condensing	-30	80	°C

DC Electrical Characteristics

Item	Symbol	Condition	Min.	Typ.	Max.	Unit
Power Supply Voltage	TPVDD	-	2.8	-	3.3	V

Optical Characteristics

Item	Standard Value	Unit
Total light transmittance	85% or more	-
Hardness	≥7H	-

I²C Timing

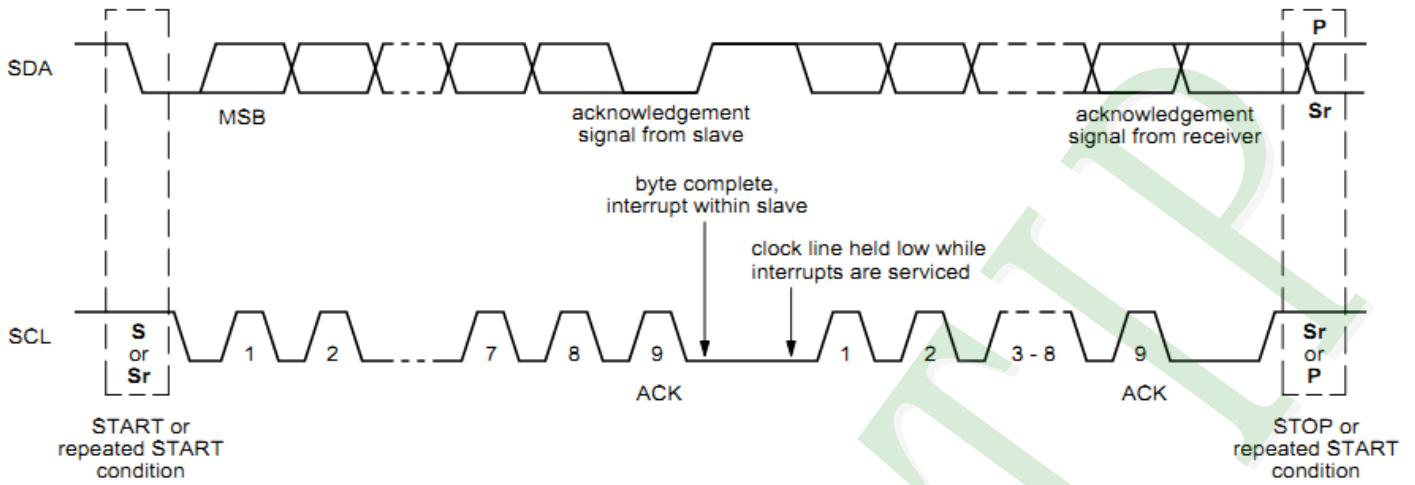

I²C Write Interface description

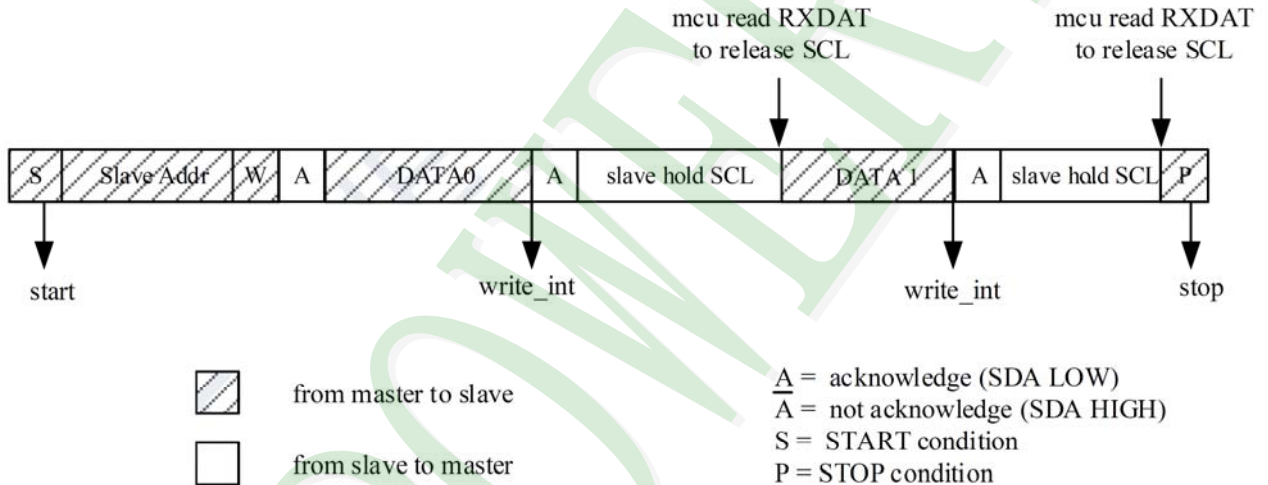

I²C Read Interface description

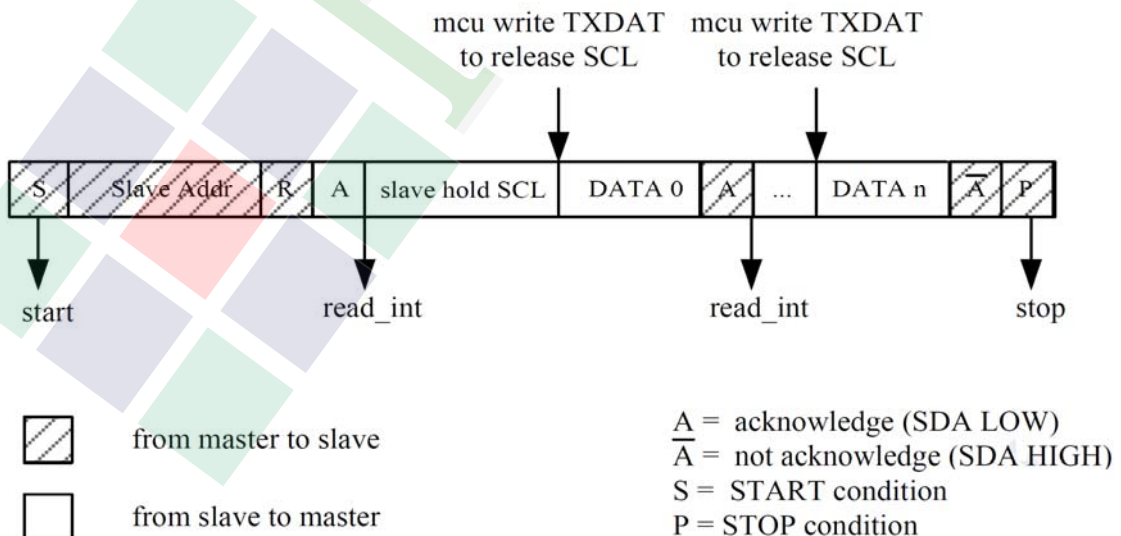

2. MODULE STRUCTURE

2.1 Counter Drawing

2.1.1 LCM Mechanical Diagram

* See Appendix

2.1.2 Block Diagram

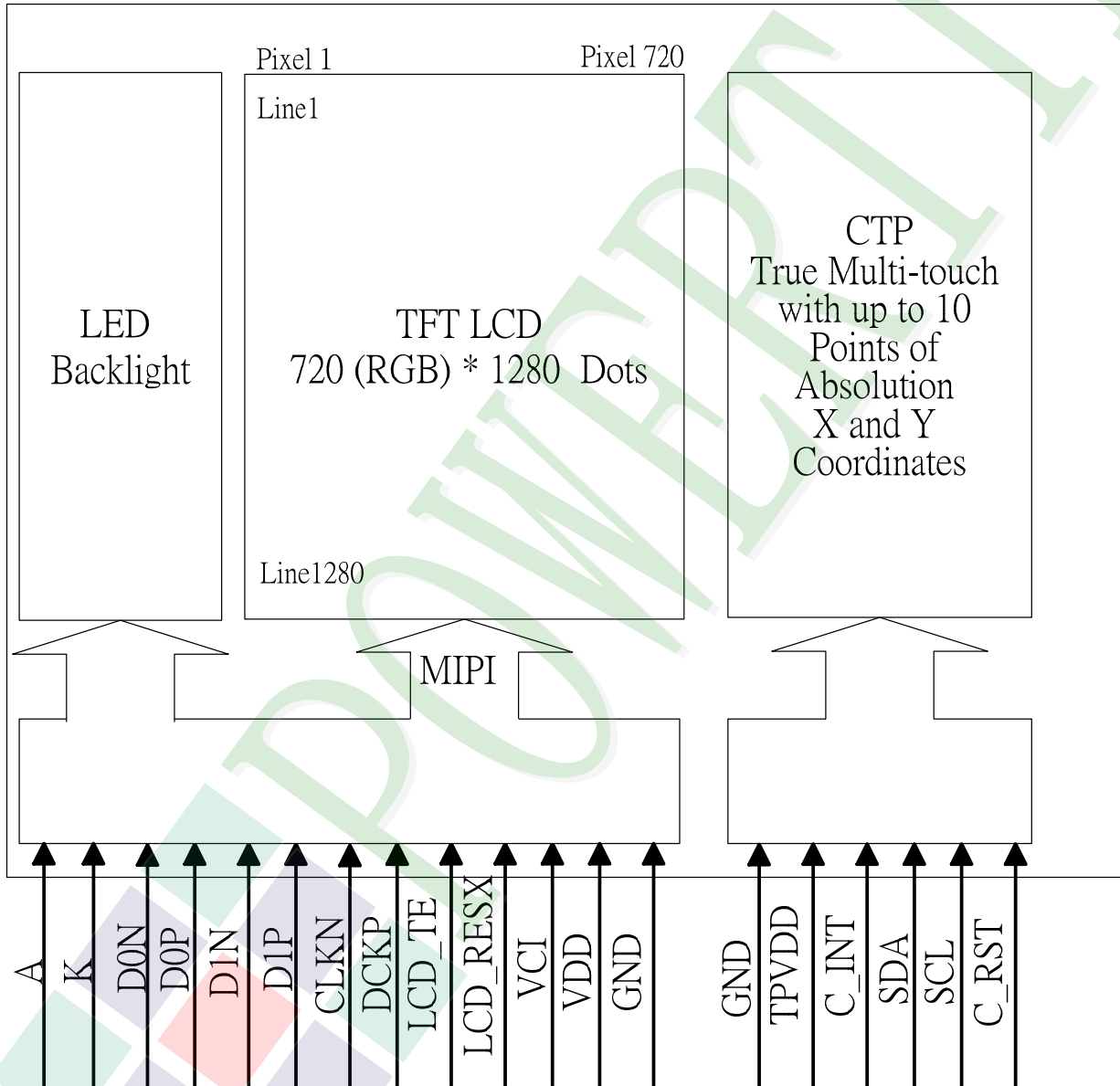

2.2 Interface Pin Description

LCM interface

Pin#	Name	DESCRIPTION
1	NC	No Connection
2	K	Power Supply for LED Backlight cathode input
3	A	Power Supply for LED Backlight anode input
4	NC	No Connection
5	NC	No Connection
6	GND	Ground.
7	NC	No Connection
8	NC	No Connection
9	VDD	Power Supply for internal logic regulator.
10	VCI	Power Supply for analog circuit
11	GND	Ground.
12	LCD_RESX	The external reset pin.
13	LCD_TE	Tearing effect output pin .
14	GND	Ground.
15	CLKP	MIPI Differential Clock Pair.
16	CLKN	MIPI Differential Clock Pair.
17	GND	Ground.
18	D1P	MIPI Differential Data Pair. (Data Lane 1)
19	D1N	MIPI Differential Data Pair. (Data Lane 1)
20	GND	Ground.
21	D0P	MIPI Differential Data Pair. (Data Lane 0)
22	D0N	MIPI Differential Data Pair. (Data Lane 0)
23	GND	Ground.
24	NC	No Connection

Capacitive Touch Panel (CTP) Interface

Pin No.	Symbol	Function
1	C_RST	RESET.
2	SCL	I ² C Clock.
3	SDA	I ² C Data.
4	C_INT	The interrupt from the CTP to the Host H: CTP interrupt not requested L: CTP request interrupt
5	TPVDD	Power.
6	GND	Ground.

2.3 AC Electrical Characteristics

2.3.1 Timing for DSI video mode

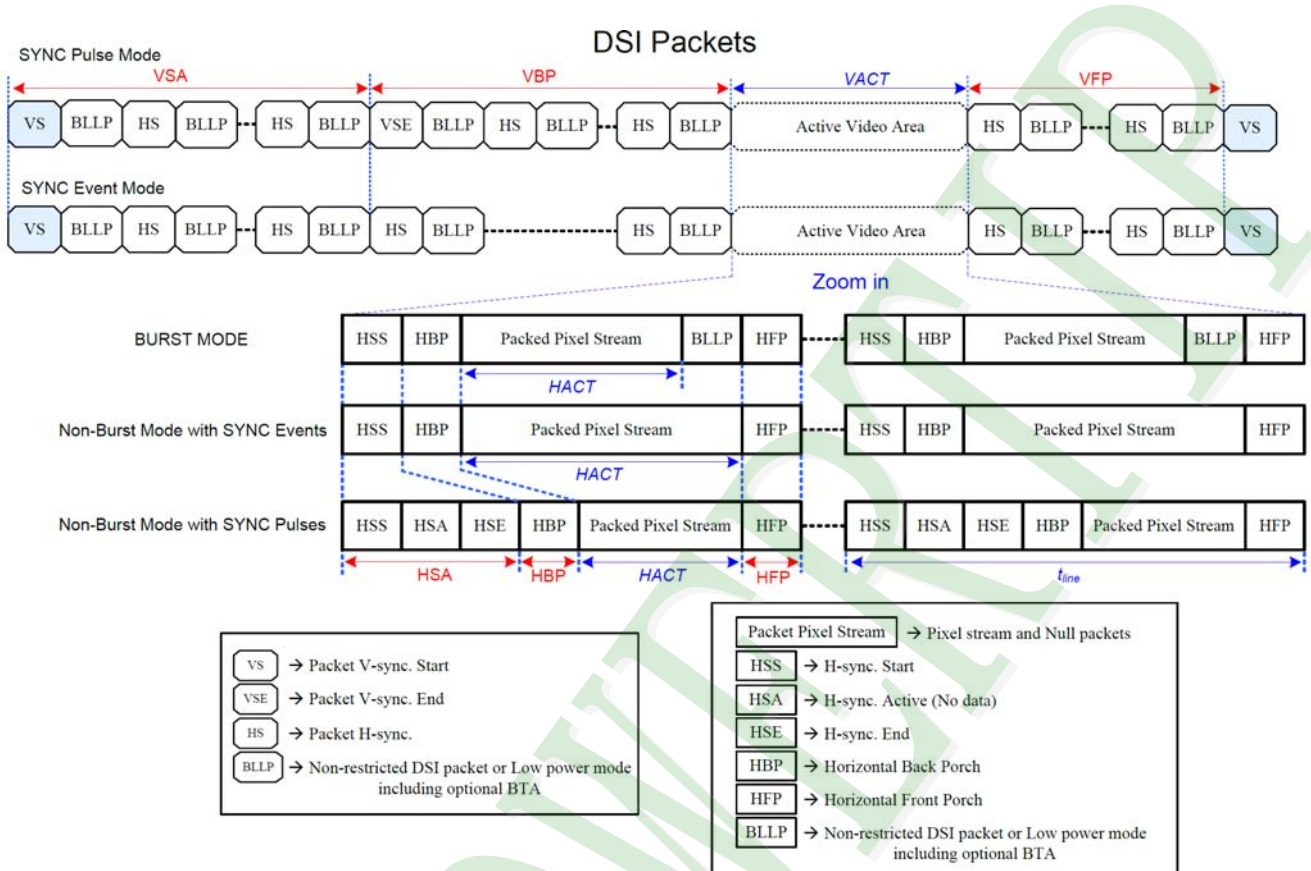

Parameters	Symbols	Min.	Typ.	Max.	Units
Vertical sync. active	VSA	2 (Note 6)	-	-	Line
Vertical Back Porch	VBP	14 (Note 6)	-	-	Line
Vertical Front Porch	VFP	8 (Note 6)	-	-	Line
Active lines per frame	VACT	-	1280	-	Line
Horizontal sync. active	HSA	2	-	-	Pixel
Horizontal Porch period	HSA + HBP + HFP	1.6	-	-	us
Active pixels per line	HACT	-	720	-	Pixel
Bit rate	BR_{bps}	385		Note 5	Mbps/lane

1 UI=1/Bit rate

$$HSA(\text{pixel}) = (t_{HSA} \times \text{lane number}) / (UI \times \text{pixel format})$$

$$HBP(\text{pixel}) = (t_{HBP} \times \text{lane number}) / (UI \times \text{pixel format})$$

$$HFP(\text{pixel}) = (t_{HFP} \times \text{lane number}) / (UI \times \text{pixel format})$$

$$\text{Frame Rate} = \frac{BR_{bps} \times \text{Lane}_{num}}{(VACT + VSA + VBP + VFP) \times (HACT + HSA + HBP + HFP) \times \text{Pixel Format}}$$

Example : $BR_{bps} = 457 \text{Mbps/lane}$, $1UI = 2.1883 \text{ns}$, Frame rate = 60Hz, $VACT = 1280$, $VSA = 2$, $VBP = 30$, $VFP = 20$, $HACT = 720$, $HSA = 33$, $HBP = 100$, $HFP = 100$, $\text{Lane}_{num} = 4(\text{lane})$, Pixel Format = 24(bit).

Note:

1. Lane_{num}: Data lane of MIPI-DSI.
2. Pixel Format: Please reference to “4.1 DSI System Interface”.
3. The formula exists slightly error because of the host-transmission way.
4. The best frame rate setting : 2 data lanes : 50~60 Hz / 3 data lanes : 50~70 Hz / 4 data lanes : 50~70 Hz.
5. Please reference to “Table 39: Limited Clock Channel Speed”.
6. The minimum values of this table mean the limitation of IC without considering the panel GIP. The actual values of VSA, VBP and VFP will be changed by different panel GIP setting.

2.3.2 Reset Timing

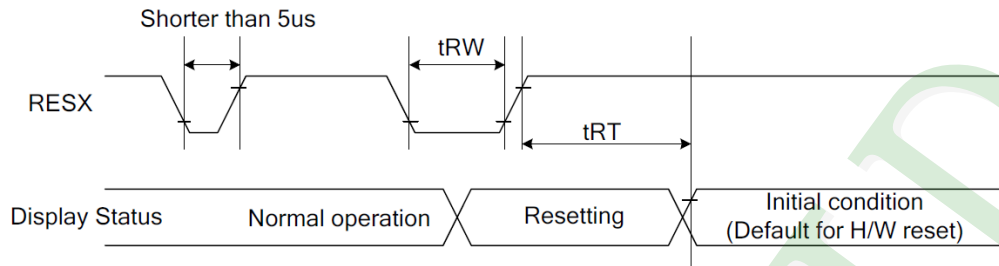

Figure 124: Reset Timing

Table 47: Reset Timing

Signal	Symbol	Parameter	Min	Max	Unit
RESX	tRW	Reset pulse duration	10		uS
	tRT	Reset cancel		5 (note 1,5) 120 (note 1,6,7)	mS mS

Notes:

1. The reset cancel also includes required time for loading ID bytes, VCOM setting and other settings from EEPROM to registers. This loading is done every time when there is H/W reset cancel time (tRT) within 5 ms after a rising edge of RESX.
2. Spike due to an electrostatic discharge on RESX line does not cause irregular system reset according to the Table 48.

Table 48: Reset Descript

RESX Pulse	Action
Shorter than 5us	Reset Rejected
Longer than 10us	Reset
Between 5us and 10us	Reset starts

3. During the Resetting period, the display will be blanked (The display enters the blanking sequence, which maximum time is 120 ms, when Reset Starts in the Sleep Out mode. The display remains the blank state in the Sleep In mode.) and then return to Default condition for Hardware Reset.
4. Spike Rejection can also be applied during a valid reset pulse, as shown below:

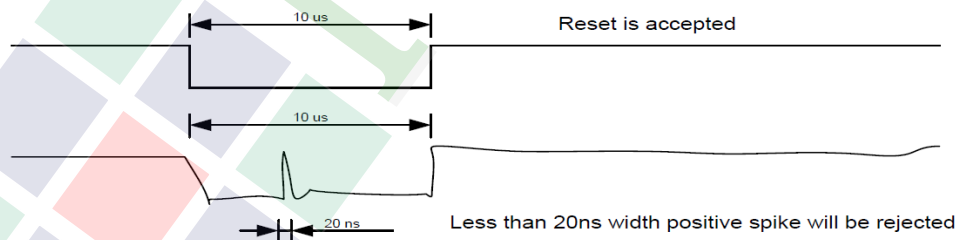

Figure 125: Positive Noise Pulse during Reset Low

5. When Reset applied during Sleep In Mode.
6. When Reset applied during Sleep Out Mode.
7. It is necessary to wait 5msec after releasing RESX before sending commands. Also Sleep Out command cannot be sent for 120msec.

2.4 Refer Initial Code :

```
//***** Reset LCD Driver *****//
LCD_nRESET = 1;
Delaysms(1); // Delay 1ms
LCD_nRESET = 0;
Delaysms(1); // Delay 1ms // This Delay time is necessary
LCD_nRESET = 1;
Delaysms(10); // Delay 120 ms
//***** Start Initial Sequence *****//
LCD_ILI9881C_CMD(0xFF);
LCD_ILI9881C_INDEX(0x98);
LCD_ILI9881C_INDEX(0x81);
LCD_ILI9881C_INDEX(0x03);

LCD_ILI9881C_CMD(0x01);
LCD_ILI9881C_INDEX(0x00);

LCD_ILI9881C_CMD(0x02);
LCD_ILI9881C_INDEX(0x00);

LCD_ILI9881C_CMD(0x03);
LCD_ILI9881C_INDEX(0x73);

LCD_ILI9881C_CMD(0x04);
LCD_ILI9881C_INDEX(0x73);

LCD_ILI9881C_CMD(0x05);
LCD_ILI9881C_INDEX(0x00);

LCD_ILI9881C_CMD(0x06);
LCD_ILI9881C_INDEX(0x06);

LCD_ILI9881C_CMD(0x07);
LCD_ILI9881C_INDEX(0x02);

LCD_ILI9881C_CMD(0x08);
LCD_ILI9881C_INDEX(0x00);

LCD_ILI9881C_CMD(0x09);
LCD_ILI9881C_INDEX(0x01);

LCD_ILI9881C_CMD(0x0a);
LCD_ILI9881C_INDEX(0x01);

LCD_ILI9881C_CMD(0x0b);
LCD_ILI9881C_INDEX(0x01);

LCD_ILI9881C_CMD(0x0c);
LCD_ILI9881C_INDEX(0x01);

LCD_ILI9881C_CMD(0x0d);
LCD_ILI9881C_INDEX(0x01);

LCD_ILI9881C_CMD(0x0e);
LCD_ILI9881C_INDEX(0x01);
```

LCD_ILI9881C_CMD(0x0f);
LCD_ILI9881C_INDEX(0x35);

LCD_ILI9881C_CMD(0x10);
LCD_ILI9881C_INDEX(0x35);

LCD_ILI9881C_CMD(0x11);
LCD_ILI9881C_INDEX(0x00);

LCD_ILI9881C_CMD(0x12);
LCD_ILI9881C_INDEX(0x00);

LCD_ILI9881C_CMD(0x13);
LCD_ILI9881C_INDEX(0x01);

LCD_ILI9881C_CMD(0x14);
LCD_ILI9881C_INDEX(0x00);

LCD_ILI9881C_CMD(0x15);
LCD_ILI9881C_INDEX(0x00);

LCD_ILI9881C_CMD(0x16);
LCD_ILI9881C_INDEX(0x00);

LCD_ILI9881C_CMD(0x17);
LCD_ILI9881C_INDEX(0x00);

LCD_ILI9881C_CMD(0x18);
LCD_ILI9881C_INDEX(0x00);

LCD_ILI9881C_CMD(0x19);
LCD_ILI9881C_INDEX(0x00);

LCD_ILI9881C_CMD(0x1a);
LCD_ILI9881C_INDEX(0x00);

LCD_ILI9881C_CMD(0x1b);
LCD_ILI9881C_INDEX(0x00);

LCD_ILI9881C_CMD(0x1c);
LCD_ILI9881C_INDEX(0x00);

LCD_ILI9881C_CMD(0x1d);
LCD_ILI9881C_INDEX(0x00);

LCD_ILI9881C_CMD(0x1e);
LCD_ILI9881C_INDEX(0xC0);

LCD_ILI9881C_CMD(0x1f);
LCD_ILI9881C_INDEX(0x80);

LCD_ILI9881C_CMD(0x20);
LCD_ILI9881C_INDEX(0x03);

LCD_ILI9881C_CMD(0x21);
LCD_ILI9881C_INDEX(0x04);

LCD_ILI9881C_CMD(0x22);
LCD_ILI9881C_INDEX(0x00);

LCD_ILI9881C_CMD(0x23);
LCD_ILI9881C_INDEX(0x00);

LCD_ILI9881C_CMD(0x24);
LCD_ILI9881C_INDEX(0x00);

LCD_ILI9881C_CMD(0x25);
LCD_ILI9881C_INDEX(0x00);

LCD_ILI9881C_CMD(0x26);
LCD_ILI9881C_INDEX(0x00);

LCD_ILI9881C_CMD(0x27);
LCD_ILI9881C_INDEX(0x00);

LCD_ILI9881C_CMD(0x28);
LCD_ILI9881C_INDEX(0x33);

LCD_ILI9881C_CMD(0x29);
LCD_ILI9881C_INDEX(0x02);

LCD_ILI9881C_CMD(0x2a);
LCD_ILI9881C_INDEX(0x00);

LCD_ILI9881C_CMD(0x2b);
LCD_ILI9881C_INDEX(0x00);

LCD_ILI9881C_CMD(0x2c);
LCD_ILI9881C_INDEX(0x00);

LCD_ILI9881C_CMD(0x2d);
LCD_ILI9881C_INDEX(0x00);

LCD_ILI9881C_CMD(0x2e);
LCD_ILI9881C_INDEX(0x00);

LCD_ILI9881C_CMD(0x2f);
LCD_ILI9881C_INDEX(0x00);

LCD_ILI9881C_CMD(0x30);
LCD_ILI9881C_INDEX(0x00);

LCD_ILI9881C_CMD(0x31);
LCD_ILI9881C_INDEX(0x00);

LCD_ILI9881C_CMD(0x32);
LCD_ILI9881C_INDEX(0x00);

LCD_ILI9881C_CMD(0x33);

LCD_ILI9881C_INDEX(0x00);

LCD_ILI9881C_CMD(0x34);
LCD_ILI9881C_INDEX(0x03);

LCD_ILI9881C_CMD(0x35);
LCD_ILI9881C_INDEX(0x00);

LCD_ILI9881C_CMD(0x36);
LCD_ILI9881C_INDEX(0x03);

LCD_ILI9881C_CMD(0x37);
LCD_ILI9881C_INDEX(0x00);

LCD_ILI9881C_CMD(0x38);
LCD_ILI9881C_INDEX(0x00);

LCD_ILI9881C_CMD(0x39);
LCD_ILI9881C_INDEX(0x00);

LCD_ILI9881C_CMD(0x3a);
LCD_ILI9881C_INDEX(0x00);

LCD_ILI9881C_CMD(0x3b);
LCD_ILI9881C_INDEX(0x00);

LCD_ILI9881C_CMD(0x3c);
LCD_ILI9881C_INDEX(0x00);

LCD_ILI9881C_CMD(0x3d);
LCD_ILI9881C_INDEX(0x00);

LCD_ILI9881C_CMD(0x3e);
LCD_ILI9881C_INDEX(0x00);

LCD_ILI9881C_CMD(0x3f);
LCD_ILI9881C_INDEX(0x00);

LCD_ILI9881C_CMD(0x40);
LCD_ILI9881C_INDEX(0x00);

LCD_ILI9881C_CMD(0x41);
LCD_ILI9881C_INDEX(0x00);

LCD_ILI9881C_CMD(0x42);
LCD_ILI9881C_INDEX(0x00);

LCD_ILI9881C_CMD(0x43);
LCD_ILI9881C_INDEX(0x00);

LCD_ILI9881C_CMD(0x44);
LCD_ILI9881C_INDEX(0x00);

LCD_ILI9881C_CMD(0x50);
LCD_ILI9881C_INDEX(0x01);

LCD_ILI9881C_CMD(0x51);
LCD_ILI9881C_INDEX(0x23);

LCD_ILI9881C_CMD(0x52);
LCD_ILI9881C_INDEX(0x45);

LCD_ILI9881C_CMD(0x53);
LCD_ILI9881C_INDEX(0x67);

LCD_ILI9881C_CMD(0x54);
LCD_ILI9881C_INDEX(0x89);

LCD_ILI9881C_CMD(0x55);
LCD_ILI9881C_INDEX(0xab);

LCD_ILI9881C_CMD(0x56);
LCD_ILI9881C_INDEX(0x01);

LCD_ILI9881C_CMD(0x57);
LCD_ILI9881C_INDEX(0x23);

LCD_ILI9881C_CMD(0x58);
LCD_ILI9881C_INDEX(0x45);

LCD_ILI9881C_CMD(0x59);
LCD_ILI9881C_INDEX(0x67);

LCD_ILI9881C_CMD(0x5a);
LCD_ILI9881C_INDEX(0x89);

LCD_ILI9881C_CMD(0x5b);
LCD_ILI9881C_INDEX(0xab);

LCD_ILI9881C_CMD(0x5c);
LCD_ILI9881C_INDEX(0xcd);

LCD_ILI9881C_CMD(0x5d);
LCD_ILI9881C_INDEX(0xef);

LCD_ILI9881C_CMD(0x5e);
LCD_ILI9881C_INDEX(0x10);

LCD_ILI9881C_CMD(0x5f);
LCD_ILI9881C_INDEX(0x09);

LCD_ILI9881C_CMD(0x60);
LCD_ILI9881C_INDEX(0x08);

LCD_ILI9881C_CMD(0x61);
LCD_ILI9881C_INDEX(0x0F);

LCD_ILI9881C_CMD(0x62);
LCD_ILI9881C_INDEX(0x0E);

LCD_ILI9881C_CMD(0x63);
LCD_ILI9881C_INDEX(0x0D);

LCD_ILI9881C_CMD(0x64);
LCD_ILI9881C_INDEX(0x0C);

LCD_ILI9881C_CMD(0x65);
LCD_ILI9881C_INDEX(0x02);

LCD_ILI9881C_CMD(0x66);
LCD_ILI9881C_INDEX(0x02);

LCD_ILI9881C_CMD(0x67);
LCD_ILI9881C_INDEX(0x02);

LCD_ILI9881C_CMD(0x68);
LCD_ILI9881C_INDEX(0x02);

LCD_ILI9881C_CMD(0x69);
LCD_ILI9881C_INDEX(0x02);

LCD_ILI9881C_CMD(0x6a);
LCD_ILI9881C_INDEX(0x02);

LCD_ILI9881C_CMD(0x6b);
LCD_ILI9881C_INDEX(0x02);

LCD_ILI9881C_CMD(0x6c);
LCD_ILI9881C_INDEX(0x02);

LCD_ILI9881C_CMD(0x6d);
LCD_ILI9881C_INDEX(0x02);

LCD_ILI9881C_CMD(0x6e);
LCD_ILI9881C_INDEX(0x02);

LCD_ILI9881C_CMD(0x6f);
LCD_ILI9881C_INDEX(0x02);

LCD_ILI9881C_CMD(0x70);
LCD_ILI9881C_INDEX(0x02);

LCD_ILI9881C_CMD(0x71);
LCD_ILI9881C_INDEX(0x06);

LCD_ILI9881C_CMD(0x72);
LCD_ILI9881C_INDEX(0x07);

LCD_ILI9881C_CMD(0x73);
LCD_ILI9881C_INDEX(0x02);

LCD_ILI9881C_CMD(0x74);
LCD_ILI9881C_INDEX(0x02);

LCD_ILI9881C_CMD(0x75);

LCD_ILI9881C_INDEX(0x06);

LCD_ILI9881C_CMD(0x76);
LCD_ILI9881C_INDEX(0x07);

LCD_ILI9881C_CMD(0x77);
LCD_ILI9881C_INDEX(0x0E);

LCD_ILI9881C_CMD(0x78);
LCD_ILI9881C_INDEX(0x0F);

LCD_ILI9881C_CMD(0x79);
LCD_ILI9881C_INDEX(0x0C);

LCD_ILI9881C_CMD(0x7a);
LCD_ILI9881C_INDEX(0x0D);

LCD_ILI9881C_CMD(0x7b);
LCD_ILI9881C_INDEX(0x02);

LCD_ILI9881C_CMD(0x7c);
LCD_ILI9881C_INDEX(0x02);

LCD_ILI9881C_CMD(0x7d);
LCD_ILI9881C_INDEX(0x02);

LCD_ILI9881C_CMD(0x7e);
LCD_ILI9881C_INDEX(0x02);

LCD_ILI9881C_CMD(0x7f);
LCD_ILI9881C_INDEX(0x02);

LCD_ILI9881C_CMD(0x80);
LCD_ILI9881C_INDEX(0x02);

LCD_ILI9881C_CMD(0x81);
LCD_ILI9881C_INDEX(0x02);

LCD_ILI9881C_CMD(0x82);
LCD_ILI9881C_INDEX(0x02);

LCD_ILI9881C_CMD(0x83);
LCD_ILI9881C_INDEX(0x02);

LCD_ILI9881C_CMD(0x84);
LCD_ILI9881C_INDEX(0x02);

LCD_ILI9881C_CMD(0x85);
LCD_ILI9881C_INDEX(0x02);

LCD_ILI9881C_CMD(0x86);
LCD_ILI9881C_INDEX(0x02);

LCD_ILI9881C_CMD(0x87);
LCD_ILI9881C_INDEX(0x09);

LCD_ILI9881C_CMD(0x88);
LCD_ILI9881C_INDEX(0x08);

LCD_ILI9881C_CMD(0x89);
LCD_ILI9881C_INDEX(0x02);

LCD_ILI9881C_CMD(0x8A);
LCD_ILI9881C_INDEX(0x02);

LCD_ILI9881C_CMD(0xFF);
LCD_ILI9881C_INDEX(0x98);
LCD_ILI9881C_INDEX(0x81);
LCD_ILI9881C_INDEX(0x04);

LCD_ILI9881C_CMD(0x6C);
LCD_ILI9881C_INDEX(0x15);

LCD_ILI9881C_CMD(0x6E);
LCD_ILI9881C_INDEX(0x2A);

LCD_ILI9881C_CMD(0x6F);
LCD_ILI9881C_INDEX(0x57);

LCD_ILI9881C_CMD(0x3A);
LCD_ILI9881C_INDEX(0xA4);

LCD_ILI9881C_CMD(0x8D);
LCD_ILI9881C_INDEX(0x1A);

LCD_ILI9881C_CMD(0x87);
LCD_ILI9881C_INDEX(0xBA);

LCD_ILI9881C_CMD(0x26);
LCD_ILI9881C_INDEX(0x76);

LCD_ILI9881C_CMD(0xB2);
LCD_ILI9881C_INDEX(0xD1);

LCD_ILI9881C_CMD(0xFF);
LCD_ILI9881C_INDEX(0x98);
LCD_ILI9881C_INDEX(0x81);
LCD_ILI9881C_INDEX(0x01);

LCD_ILI9881C_CMD(0x22);
LCD_ILI9881C_INDEX(0x0A);

LCD_ILI9881C_CMD(0x31);
LCD_ILI9881C_INDEX(0x00);

LCD_ILI9881C_CMD(0x53);
LCD_ILI9881C_INDEX(0x35);

LCD_ILI9881C_CMD(0x55);
LCD_ILI9881C_INDEX(0x50);

LCD_ILI9881C_CMD(0x50);
LCD_ILI9881C_INDEX(0xAF);

LCD_ILI9881C_CMD(0x51);
LCD_ILI9881C_INDEX(0xAF);

LCD_ILI9881C_CMD(0x60);
LCD_ILI9881C_INDEX(0x14);

LCD_ILI9881C_CMD(0xA0);
LCD_ILI9881C_INDEX(0x08);

LCD_ILI9881C_CMD(0xA1);
LCD_ILI9881C_INDEX(0x1D);

LCD_ILI9881C_CMD(0xA2);
LCD_ILI9881C_INDEX(0x2C);

LCD_ILI9881C_CMD(0xA3);
LCD_ILI9881C_INDEX(0x14);

LCD_ILI9881C_CMD(0xA4);
LCD_ILI9881C_INDEX(0x19);

LCD_ILI9881C_CMD(0xA5);
LCD_ILI9881C_INDEX(0x2E);

LCD_ILI9881C_CMD(0xA6);
LCD_ILI9881C_INDEX(0x22);

LCD_ILI9881C_CMD(0xA7);
LCD_ILI9881C_INDEX(0x23);

LCD_ILI9881C_CMD(0xA8);
LCD_ILI9881C_INDEX(0x97);

LCD_ILI9881C_CMD(0xA9);
LCD_ILI9881C_INDEX(0x1E);

LCD_ILI9881C_CMD(0xAA);
LCD_ILI9881C_INDEX(0x29);

LCD_ILI9881C_CMD(0xAB);
LCD_ILI9881C_INDEX(0x7B);

LCD_ILI9881C_CMD(0xAC);
LCD_ILI9881C_INDEX(0x18);

LCD_ILI9881C_CMD(0xAD);
LCD_ILI9881C_INDEX(0x17);

LCD_ILI9881C_CMD(0xAE);
LCD_ILI9881C_INDEX(0x4B);

LCD_ILI9881C_CMD(0xAF);
LCD_ILI9881C_INDEX(0x1F);

LCD_ILI9881C_CMD(0xB0);
LCD_ILI9881C_INDEX(0x27);

LCD_ILI9881C_CMD(0xB1);
LCD_ILI9881C_INDEX(0x52);

LCD_ILI9881C_CMD(0xB2);
LCD_ILI9881C_INDEX(0x63);

LCD_ILI9881C_CMD(0xB3);
LCD_ILI9881C_INDEX(0x39);

LCD_ILI9881C_CMD(0xC0);
LCD_ILI9881C_INDEX(0x08);

LCD_ILI9881C_CMD(0xC1);
LCD_ILI9881C_INDEX(0x1D);

LCD_ILI9881C_CMD(0xC2);
LCD_ILI9881C_INDEX(0x2C);

LCD_ILI9881C_CMD(0xC3);
LCD_ILI9881C_INDEX(0x14);

LCD_ILI9881C_CMD(0xC4);
LCD_ILI9881C_INDEX(0x19);

LCD_ILI9881C_CMD(0xC5);
LCD_ILI9881C_INDEX(0x2E);

LCD_ILI9881C_CMD(0xC6);
LCD_ILI9881C_INDEX(0x22);

LCD_ILI9881C_CMD(0xC7);
LCD_ILI9881C_INDEX(0x23);

LCD_ILI9881C_CMD(0xC8);
LCD_ILI9881C_INDEX(0x97);

LCD_ILI9881C_CMD(0xC9);
LCD_ILI9881C_INDEX(0x1E);

LCD_ILI9881C_CMD(0xCA);
LCD_ILI9881C_INDEX(0x29);

LCD_ILI9881C_CMD(0xCB);
LCD_ILI9881C_INDEX(0x7B);

LCD_ILI9881C_CMD(0xCC);
LCD_ILI9881C_INDEX(0x18);

LCD_ILI9881C_CMD(0xCD);

```
LCD_ILI9881C_INDEX(0x17);
```

```
LCD_ILI9881C_CMD(0xCE);  
LCD_ILI9881C_INDEX(0x4B);
```

```
LCD_ILI9881C_CMD(0xCF);  
LCD_ILI9881C_INDEX(0x1F);
```

```
LCD_ILI9881C_CMD(0xD0);  
LCD_ILI9881C_INDEX(0x27);
```

```
LCD_ILI9881C_CMD(0xD1);  
LCD_ILI9881C_INDEX(0x52);
```

```
LCD_ILI9881C_CMD(0xD2);  
LCD_ILI9881C_INDEX(0x63);
```

```
LCD_ILI9881C_CMD(0xD3);  
LCD_ILI9881C_INDEX(0x39);
```

```
LCD_ILI9881C_CMD(0xFF);  
LCD_ILI9881C_INDEX(0x98);  
LCD_ILI9881C_INDEX(0x81);  
LCD_ILI9881C_INDEX(0x00);
```

```
LCD_ILI9881C_CMD(0x35);
```

```
Void ILI9881C_EnterSleep_Code(Void)  
{  
LCD_ILI9881C_CMD(0x28) //Display oFF  
Delays(20);  
LCD_ILI9881C_CMD(0x10); // Internal oscillator will be stopped  
Delays(120);  
}  
Void ILI9881C_ExitSleep_Code(Void)  
{  
LCD_ILI9881C_CMD(0x11); // Sleep Out  
Delays(120);  
LCD_ILI9881C_CMD(0x29) //Display on  
Delays(20);  
}
```

3. QUALITY ASSURANCE SYSTEM

3.1 Quality Assurance Flow Chart

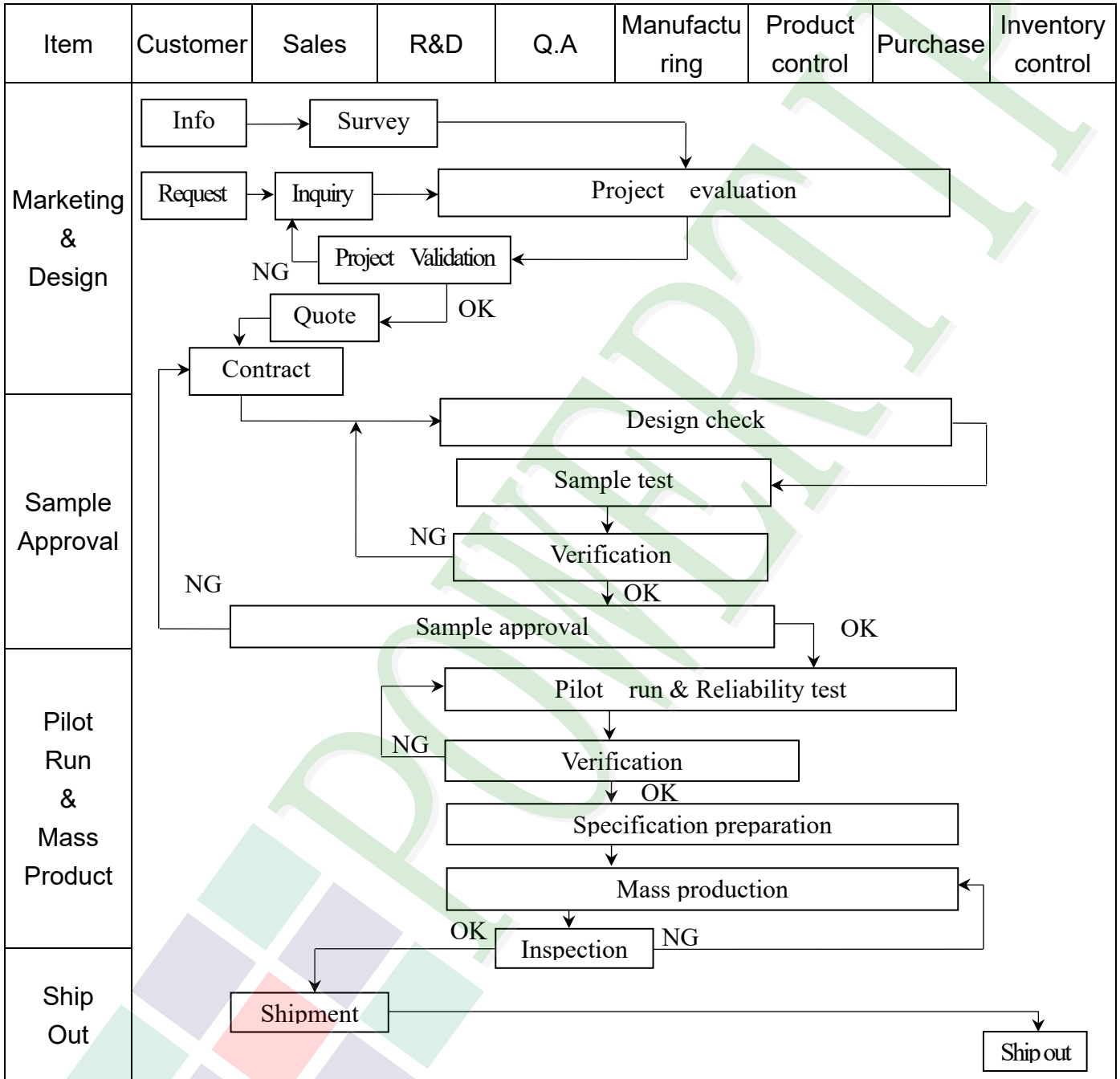

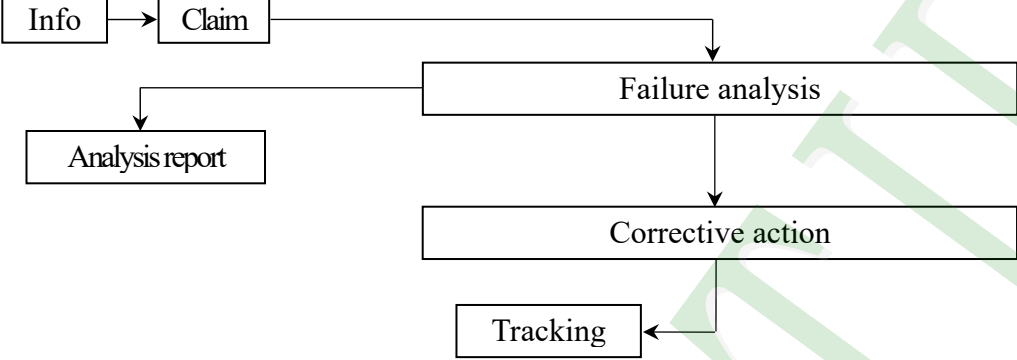
Item	Customer	Sales	R&D	Q.A	Manufacturing	Product control	Purchase	Inventory control
Sales Service	 <pre> graph TD Info[Info] --> Claim[Claim] Claim --> Failure[Failure analysis] Failure --> Analysis[Analysis report] Failure --> Corrective[Corrective action] Corrective --> Tracking[Tracking] </pre>							
Q.A Activity	1. ISO 9001 Maintenance Activities 3. Equipment calibration 5. Standardization Management				2. Process improvement proposal 4. Education And Training Activities			

3.2. Inspection Specification

- ◆ **Scope:** The document shall be applied to TFT-LCD Module for PH720128T004-ZBC11 (Ver.01).
- ◆ **Inspection Standard:** MIL-STD-105E Table Normal Inspection Single Sampling Level II.
- ◆ **Equipment:** Gauge, MIL-STD, Powertip Tester, Sample
- ◆ **Defect Level:** Major Defect AQL: 0. 4; Minor Defect AQL: 1. 5
- ◆ **OUT Going Defect Level:** Sampling.
- ◆ **Standard of the product appearance test:**

a. Manner of appearance test:

- (1). The test best be under 20W×2 fluorescent light(about 300lux ~500lux)
, and distance of view must be at 30~40 cm.
- (2). The test direction is base on about around 45° of vertical line.

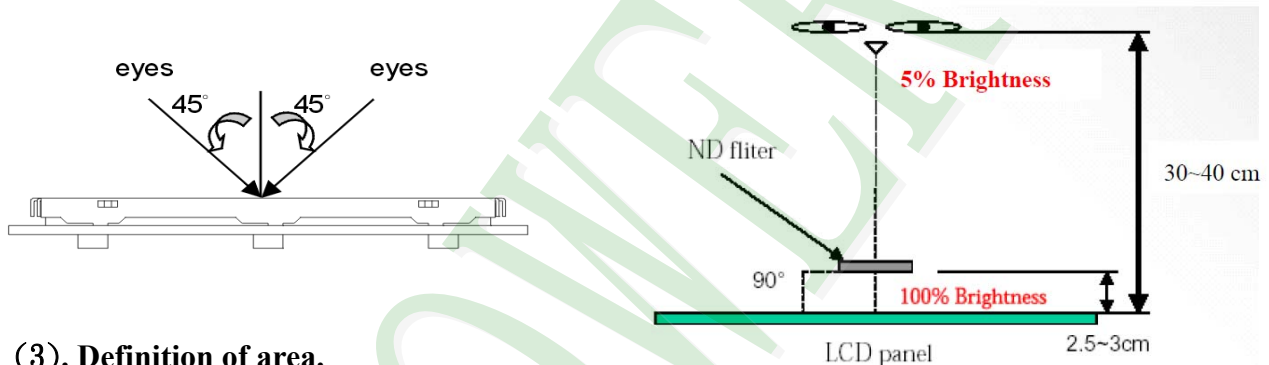

(3). Definition of area.

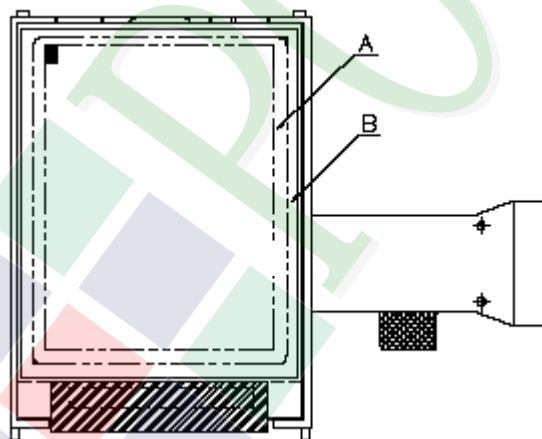

A area: viewing area

B area: Outside of viewing area

(4). Standard of inspection : (Unit : mm)

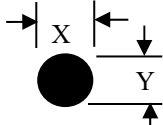
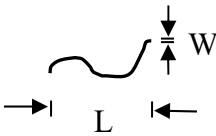

◆Specification For TFT-LCD Module PH720128T004-ZBC11 :
(Ver.01)

<u>NO</u>	<u>Item</u>	<u>Criterion</u>	<u>Level</u>												
01	Product condition	1. 1The part number is inconsistent with work order of production.	Major												
		1. 2 Mixed product types.	Major												
		1. 3 Assembled in inverse direction.	Major												
02	Quantity	2. 1The quantity is inconsistent with work order of production.	Major												
03	Outline dimension	3. 1Product dimension and structure must conform to structure diagram.	Major												
04	Electrical Testing	4. 1 Missing line character and icon.	Major												
		4. 2 No function or no display.	Major												
		4. 3 Display malfunction.	Major												
		4. 4 LCD viewing angle defect.	Major												
		4. 5 Current consumption exceeds product specifications.	Major												
		4. 6Mura cannot be seen through 5% ND filter at 50% Gray , should be judged by the viewing angle of 90 degree.	Minor												
05	Dot defect (Bright dot, Dark dot) On -display	<table border="1" style="margin-left: auto; margin-right: auto;"> <thead> <tr> <th></th> <th><u>Item</u></th> <th><u>Acceptance (Q'ty)</u></th> </tr> </thead> <tbody> <tr> <td rowspan="4" style="text-align: center;"><u>Dot Defect</u></td> <td>Bright Dot</td> <td style="text-align: center;">≤ 4</td> </tr> <tr> <td>Dark Dot</td> <td style="text-align: center;">≤ 5</td> </tr> <tr> <td>Joint Dot</td> <td style="text-align: center;">≤ 3</td> </tr> <tr> <td>Total</td> <td style="text-align: center;">≤ 7</td> </tr> </tbody> </table>		<u>Item</u>	<u>Acceptance (Q'ty)</u>	<u>Dot Defect</u>	Bright Dot	≤ 4	Dark Dot	≤ 5	Joint Dot	≤ 3	Total	≤ 7	Minor
			<u>Item</u>	<u>Acceptance (Q'ty)</u>											
<u>Dot Defect</u>	Bright Dot	≤ 4													
	Dark Dot	≤ 5													
	Joint Dot	≤ 3													
	Total	≤ 7													
5.1 Inspection pattern: full white, full black, Red, Green and blue screens. 5.2 It is defined as dot defect if defect area $> 1/2$ dot. 5.3 The distance between two dot defect ≥ 5 mm. 5.4 Bright dot : Dots appear bright and unchanged in visible with 5% ND filter is defined. 5.5 Tiny bright dot: bright dot area $\leq 1/2$ dot. a. Dots appear bright and unchanged in visible with 5% ND filter is defined defect and is judged in accordance with 6.1 b. Dots invisible with 5% ND Filter is Ignored.															

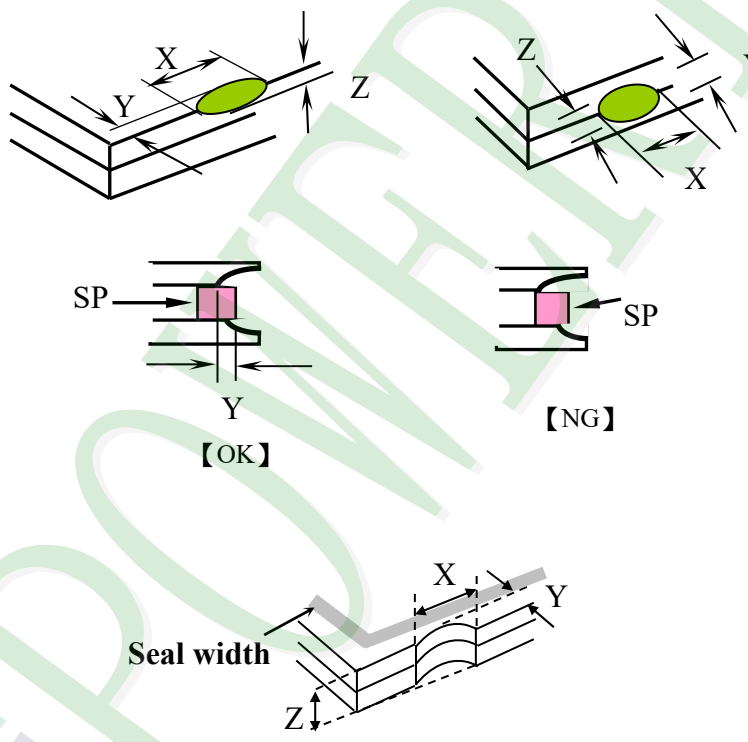
NO	Item	Criterion	Level																																					
06	<p>Black or white Dot, scratch, contamination</p> <p>Round type</p>  <p>$\Phi = (x+y) / 2$</p> <p>Line type</p> 	<p>6. 1 Round type (Non-display or display):</p> <table border="1" data-bbox="518 425 1316 705"> <thead> <tr> <th rowspan="2">Dimension (diameter: Φ)</th> <th colspan="2">Acceptance (Q'ty)</th> </tr> <tr> <th>A area</th> <th>B area</th> </tr> </thead> <tbody> <tr> <td>$\Phi \leq 0.25$</td> <td>Ignore</td> <td rowspan="4">Ignore</td> </tr> <tr> <td>$0.25 < \Phi \leq 0.35$</td> <td>5</td> </tr> <tr> <td>$\Phi > 0.35$</td> <td>0</td> </tr> <tr> <td>Total</td> <td>5</td> </tr> </tbody> </table> <p>6. 2 Line type(Non-display or display):</p> <table border="1" data-bbox="518 907 1316 1232"> <thead> <tr> <th rowspan="2">Length (L)</th> <th rowspan="2">Width (W)</th> <th colspan="2">Acceptance (Q'ty)</th> </tr> <tr> <th>A area</th> <th>B area</th> </tr> </thead> <tbody> <tr> <td>---</td> <td>$W \leq 0.03$</td> <td>Ignore</td> <td rowspan="4">Ignore</td> </tr> <tr> <td>$L \leq 10.0$</td> <td>$0.03 < W \leq 0.05$</td> <td>4</td> </tr> <tr> <td>$L \leq 5.0$</td> <td>$0.05 < W \leq 0.10$</td> <td>2</td> </tr> <tr> <td>---</td> <td>$W > 0.10$</td> <td>As round type</td> </tr> <tr> <td colspan="2">Total</td> <td>5</td> <td></td> </tr> </tbody> </table>	Dimension (diameter: Φ)	Acceptance (Q'ty)		A area	B area	$\Phi \leq 0.25$	Ignore	Ignore	$0.25 < \Phi \leq 0.35$	5	$\Phi > 0.35$	0	Total	5	Length (L)	Width (W)	Acceptance (Q'ty)		A area	B area	---	$W \leq 0.03$	Ignore	Ignore	$L \leq 10.0$	$0.03 < W \leq 0.05$	4	$L \leq 5.0$	$0.05 < W \leq 0.10$	2	---	$W > 0.10$	As round type	Total		5		Minor
Dimension (diameter: Φ)	Acceptance (Q'ty)																																							
	A area	B area																																						
$\Phi \leq 0.25$	Ignore	Ignore																																						
$0.25 < \Phi \leq 0.35$	5																																							
$\Phi > 0.35$	0																																							
Total	5																																							
Length (L)	Width (W)	Acceptance (Q'ty)																																						
		A area	B area																																					
---	$W \leq 0.03$	Ignore	Ignore																																					
$L \leq 10.0$	$0.03 < W \leq 0.05$	4																																						
$L \leq 5.0$	$0.05 < W \leq 0.10$	2																																						
---	$W > 0.10$	As round type																																						
Total		5																																						
07	Polarizer Bubble	<table border="1" data-bbox="454 1456 1372 1769"> <thead> <tr> <th rowspan="2">Dimension (diameter: Φ)</th> <th colspan="2">Acceptance (Q'ty)</th> </tr> <tr> <th>A area</th> <th>B area</th> </tr> </thead> <tbody> <tr> <td>$\Phi \leq 0.25$</td> <td>Ignore</td> <td rowspan="4">Ignore</td> </tr> <tr> <td>$0.25 < \Phi \leq 0.50$</td> <td>4</td> </tr> <tr> <td>$0.50 < \Phi \leq 0.80$</td> <td>1</td> </tr> <tr> <td>$\Phi > 0.80$</td> <td>0</td> </tr> <tr> <td>Total</td> <td>5</td> <td></td> </tr> </tbody> </table>	Dimension (diameter: Φ)	Acceptance (Q'ty)		A area	B area	$\Phi \leq 0.25$	Ignore	Ignore	$0.25 < \Phi \leq 0.50$	4	$0.50 < \Phi \leq 0.80$	1	$\Phi > 0.80$	0	Total	5		Minor																				
Dimension (diameter: Φ)	Acceptance (Q'ty)																																							
	A area	B area																																						
$\Phi \leq 0.25$	Ignore	Ignore																																						
$0.25 < \Phi \leq 0.50$	4																																							
$0.50 < \Phi \leq 0.80$	1																																							
$\Phi > 0.80$	0																																							
Total	5																																							

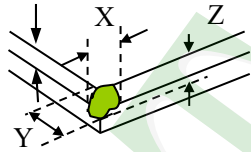
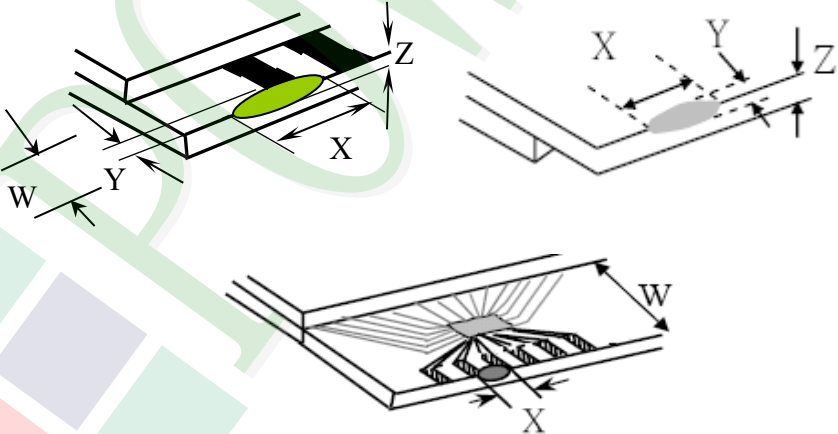
<u>NO</u>	<u>Item</u>	<u>Criterion</u>	<u>Level</u>									
08	The crack of glass	<p>Symbols :</p> <p>X: The length of crack Z: The thickness of crack T: The thickness of glass</p> <p>Y: The width of crack. W: terminal length a : LCD side length</p> <hr/> <p>8.1 General glass chip: 8.1.1 Chip on panel surface and crack between panels:</p>  <table border="1" data-bbox="459 1579 1276 1870"> <thead> <tr> <th><u>X</u></th> <th><u>Y</u></th> <th><u>Z</u></th> </tr> </thead> <tbody> <tr> <td>$\leq a$</td> <td>Crack can't enter viewing area</td> <td>$\leq 1/2 t$</td> </tr> <tr> <td>$\leq a$</td> <td>Crack can't exceed the half of SP width.</td> <td>$1/2 t < Z \leq 2 t$</td> </tr> </tbody> </table>	<u>X</u>	<u>Y</u>	<u>Z</u>	$\leq a$	Crack can't enter viewing area	$\leq 1/2 t$	$\leq a$	Crack can't exceed the half of SP width.	$1/2 t < Z \leq 2 t$	Minor
		<u>X</u>	<u>Y</u>	<u>Z</u>								
$\leq a$	Crack can't enter viewing area	$\leq 1/2 t$										
$\leq a$	Crack can't exceed the half of SP width.	$1/2 t < Z \leq 2 t$										

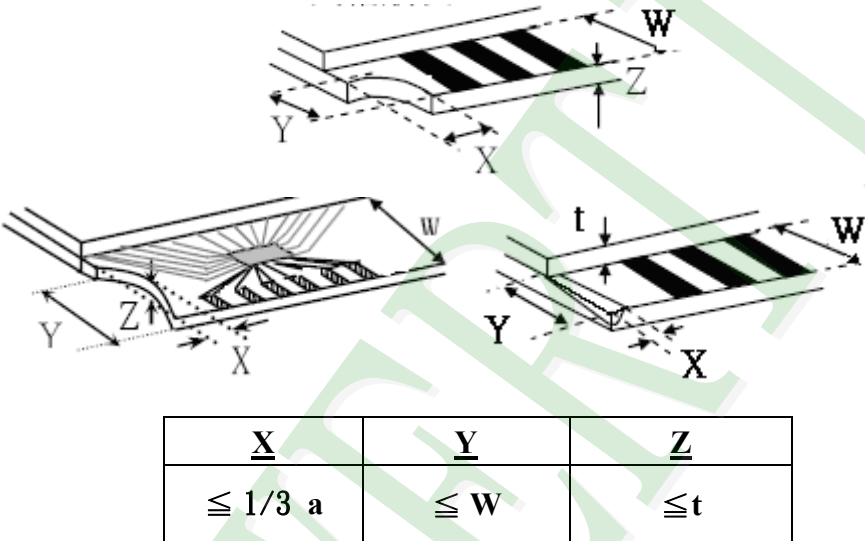
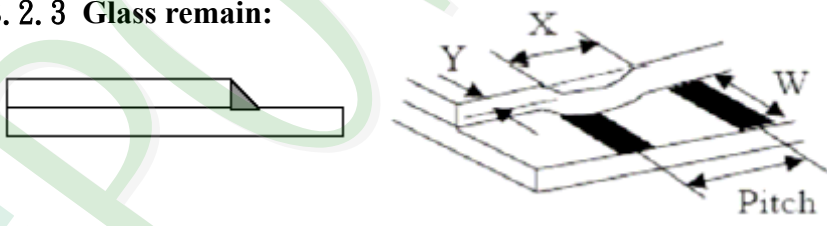
<u>NO</u>	<u>Item</u>	<u>Criterion</u>	<u>Level</u>										
08	The crack of glass	<p>Symbols :</p> <p>X: The length of crack Z: The thickness of crack t: The thickness of glass</p> <p>Y: The width of crack. W: terminal length a: LCD side length</p> <hr/> <p>8.1.2 Corner crack:</p>  <table border="1" data-bbox="461 763 1278 1059"> <thead> <tr> <th><u>X</u></th> <th><u>Y</u></th> <th><u>Z</u></th> </tr> </thead> <tbody> <tr> <td>$\leq 1/5 a$</td> <td>Crack can't enter viewing area</td> <td>$Z \leq 1/2 t$</td> </tr> <tr> <td>$\leq 1/5 a$</td> <td>Crack can't exceed the half of SP width.</td> <td>$1/2 t < Z \leq 2 t$</td> </tr> </tbody> </table>	<u>X</u>	<u>Y</u>	<u>Z</u>	$\leq 1/5 a$	Crack can't enter viewing area	$Z \leq 1/2 t$	$\leq 1/5 a$	Crack can't exceed the half of SP width.	$1/2 t < Z \leq 2 t$	Minor	
		<u>X</u>	<u>Y</u>	<u>Z</u>									
$\leq 1/5 a$	Crack can't enter viewing area	$Z \leq 1/2 t$											
$\leq 1/5 a$	Crack can't exceed the half of SP width.	$1/2 t < Z \leq 2 t$											
<p>8.2 Protrusion over terminal:</p> <p>8.2.1 Chip on electrode pad:</p>  <table border="1" data-bbox="499 1697 1287 1872"> <thead> <tr> <th></th> <th><u>X</u></th> <th><u>Y</u></th> <th><u>Z</u></th> </tr> </thead> <tbody> <tr> <td><u>Front</u></td> <td>$\leq a$</td> <td>$\leq 1/2 W$</td> <td>$\leq t$</td> </tr> <tr> <td><u>Back</u></td> <td>$\leq a$</td> <td>$\leq W$</td> <td>$\leq 1/2 t$</td> </tr> </tbody> </table>		<u>X</u>	<u>Y</u>	<u>Z</u>	<u>Front</u>	$\leq a$	$\leq 1/2 W$	$\leq t$	<u>Back</u>	$\leq a$	$\leq W$	$\leq 1/2 t$	Minor
	<u>X</u>	<u>Y</u>	<u>Z</u>										
<u>Front</u>	$\leq a$	$\leq 1/2 W$	$\leq t$										
<u>Back</u>	$\leq a$	$\leq W$	$\leq 1/2 t$										

<u>NO</u>	<u>Item</u>	<u>Criterion</u>	<u>Level</u>									
08	The crack of glass	<p>Symbols:</p> <p>X: The length of crack Z: The thickness of crack t: The thickness of glass</p> <p>Y: The width of crack. W: terminal length a: LCD side length</p>	Minor									
		<p>8.2.2 Non-conductive portion:</p>  <table border="1" data-bbox="625 963 1257 1086"> <thead> <tr> <th><u>X</u></th> <th><u>Y</u></th> <th><u>Z</u></th> </tr> </thead> <tbody> <tr> <td>$\leq 1/3 a$</td> <td>$\leq W$</td> <td>$\leq t$</td> </tr> </tbody> </table> <p>⊙ If the chipped area touches the ITO terminal, over 2/3 of the ITO must remain and be inspected according to electrode terminal specifications</p> <p>8.2.3 Glass remain:</p>  <table border="1" data-bbox="547 1523 1241 1646"> <thead> <tr> <th><u>X</u></th> <th><u>Y</u></th> <th><u>Z</u></th> </tr> </thead> <tbody> <tr> <td>$\leq a$</td> <td>$\leq 1/3 W$</td> <td>$\leq t$</td> </tr> </tbody> </table> <p>8.2.4 Cracking:</p>  <p style="text-align: center;">Not Allowed</p>		<u>X</u>	<u>Y</u>	<u>Z</u>	$\leq 1/3 a$	$\leq W$	$\leq t$	<u>X</u>	<u>Y</u>	<u>Z</u>
<u>X</u>	<u>Y</u>	<u>Z</u>										
$\leq 1/3 a$	$\leq W$	$\leq t$										
<u>X</u>	<u>Y</u>	<u>Z</u>										
$\leq a$	$\leq 1/3 W$	$\leq t$										

◆Specification For TFT-LCD Module PH720128T004-ZBC11 :
(Ver.01)

<u>NO</u>	<u>Item</u>	<u>Criterion</u>	<u>Level</u>
09	Backlight elements	9. 1 Backlight can't work normally.	Major
		9. 2 Backlight doesn't light or color is wrong.	Major
		9. 3 Illumination source flickers when lit.	Major
10	General appearance	10. 1 Pin type, quantity, dimension must match type in structure diagram.	Major
		10. 2 No short circuits in components on PCB or FPC.	Major
		10. 3 Parts on PCB or FPC must be: no wrong parts, missing parts or excess parts.	Major
		10. 4 Product packaging must the same as specified on packaging specification sheet.	Minor
		10. 5 The folding and peeled off in polarizer are not acceptable.	Minor
		10. 6 The PCB or FPC between B/L assembled distance(PCB or FPC) is ≤ 1.5 mm.	Minor

4. RELIABILITY TEST

4.1 Reliability Test Condition

(Ver.B01)

NO.	TEST ITEM	TEST CONDITION											
1	High Temperature Storage Test	Keep in 80 ±5°C 240 hrs											
2	Low Temperature Storage Test	Keep in -30 ±5°C 240 hrs											
3	High Temperature / High Humidity Storage Test	Keep in 60 °C / 90% R.H duration for 240 hrs (Excluding the polarizer)											
4	Temperature Cycling Storage Test	$ \begin{array}{ccccccc} & -30^{\circ}\text{C} & \rightarrow & +25^{\circ}\text{C} & \rightarrow & 80^{\circ}\text{C} & \rightarrow & +25^{\circ}\text{C} \\ & (30\text{mins}) & & (5\text{mins}) & & (30\text{mins}) & & (5\text{mins}) \\ & \longleftarrow & & & & & & \longrightarrow \\ & & & & & & & \text{10 Cycle} \end{array} $											
5	ESD Test	Air Discharge: Apply 2 KV with 5 times Discharge for each polarity +/-	Contact Discharge: Apply 250 V with 5 times discharge for each polarity +/-										
		1. Temperature ambience : 15°C ~ 35°C 2. Humidity relative : 30% ~ 60% 3. Energy Storage Capacitance(Cs+Cd) : 150pF±10% 4. Discharge Resistance(Rd) : 330Ω±10% 5. Discharge, mode of operation : Single Discharge (time between successive discharges at least 1 sec) (Tolerance if the output voltage indication : ±5%)											
6	Vibration Test (Packaged)	1. Sine wave 10~55 Hz frequency (1 min/sweep) 2. The amplitude of vibration : 1.5 mm 3. Each direction (X、Y、Z) duration for 2 Hrs											
7	Drop Test (Packaged)	<table border="1" style="width: 100%; text-align: center;"> <thead> <tr> <th>Packing Weight (Kg)</th> <th>Drop Height (cm)</th> </tr> </thead> <tbody> <tr> <td>0 ~ 45.4</td> <td>122</td> </tr> <tr> <td>45.4 ~ 90.8</td> <td>76</td> </tr> <tr> <td>90.8 ~ 454</td> <td>61</td> </tr> <tr> <td>Over 454</td> <td>46</td> </tr> </tbody> </table>		Packing Weight (Kg)	Drop Height (cm)	0 ~ 45.4	122	45.4 ~ 90.8	76	90.8 ~ 454	61	Over 454	46
		Packing Weight (Kg)	Drop Height (cm)										
0 ~ 45.4	122												
45.4 ~ 90.8	76												
90.8 ~ 454	61												
Over 454	46												
		Drop Direction : ※1 corner / 3 edges / 6 sides each 1time											

◎Result Evaluation Criteria :

Under the display quality test conditions with normal operations with normal operation state.
 Do not change these conditions as such changes may affect practical display function.
 (Normal operation state)

Temperature : +20~30°C

Humidity : 50~70%

Atmospheric pressure : 86~106Kpa

5. PRECAUTION RELATING PRODUCT HANDLING

5.1 SAFETY

- 5.1.1 If the LCD panel breaks, be careful not to get the liquid crystal to touch your skin.
- 5.1.2 If the liquid crystal touches your skin or clothes, please wash it off immediately by using soap and water.

5.2 HANDLING

- 5.2.1 Avoid any strong mechanical shock which can break the glass.
- 5.2.2 Avoid static electricity which can damage the CMOS LSI—When working with the module, be sure to ground your body and any electrical equipment you may be using.
- 5.2.3 Do not remove the panel or frame from the module.
- 5.2.4 The polarizing plate of the display is very fragile. So, please handle it very carefully, do not touch, push or rub the exposed polarizing with anything harder than an HB pencil lead (glass, tweezers, etc.)
- 5.2.5 Do not wipe the polarizing plate with a dry cloth, as it may easily scratch the surface of plate.
- 5.2.6 Do not touch the display area with bare hands, this will stain the display area.
- 5.2.7 Do not use ketonic solvent & aromatic solvent. Use with a soft cloth soaked with a cleaning naphtha solvent.
- 5.2.8 To control temperature and time of soldering is $320 \pm 10^{\circ}\text{C}$ and 3 ~ 5 sec.
- 5.2.9 To avoid liquid (include organic solvent) stained on LCM.
- 5.2.10 Caution! (LCM products with Capacitive Touch Panel)
Strong EMI-sources such as switch-mode power supplies (SPS) can lead to touch malfunction (e.g., ghost-touches). Therefore, the touch needs to be thoroughly tested inside the target application.
- 5.2.11 CAUTION: Continuously displaying same static image will result in high possibility of image sticking/image burn-in effect due to TFT panel characteristic.
- 5.2.12 Double-sided tape designed to be attached with the customer's mechanical device, please follow up the rules and regulations published by the original manufacturer of double-side tape for the attachment operation.

5.3 STORAGE

- 5.3.1 Store the panel or module in a dark place where the temperature is $25^{\circ}\text{C} \pm 5^{\circ}\text{C}$ and the humidity is below 65% RH.
- 5.3.2 Do not place the module near organics solvents or corrosive gases.
- 5.3.3 Do not crush, shake, or jolt the module.

5.4 TERMS OF WARRANTY

- 5.4.1 Applicable warrant period
The period is within thirteen months since the date of shipping out under normal using and storage conditions.
- 5.4.2 Unaccepted responsibility
This product has been manufactured to your company's specification as a part for use in your company's general electronic products. It is guaranteed to perform according to delivery specifications. For any other use apart from general electronic equipment, we cannot take responsibility if the product is used in nuclear power control equipment, aerospace equipment, fire and security systems or any other applications in which there is a direct risk to human life and where extremely high levels of reliability are required.

Ver.001

Documents NO. PKG-PH720128T004-ZBC11

LCM包裝規格書

LCM Packaging Specifications (For Tray)

Approve	Check	Contact
Rex	Tina	Clare

1. 包裝材料規格表 (Packaging Material) : (per carton)

No.	Item	Model	Dimensions (mm)	1Pcs Weight	Quantity	Total Weight
1	成品 (LCM)	PH720128T004-ZBC11	143.4 X 91.46	0.093	120	11.16
2	多層薄膜(1)POF	OTFILM0BA03ABA	19"X350X0.015	—	6	—
3	TRAY 盤 (2)Tray	TYSG000000135	352 X 260 X 14.2	0.099	36	3.564
4	內盒(3)Product Box	BX36627063ABBA	383 X 270 X 66	0.182	6	1.092
5	保利龍板(4)Polylon board	OTPLB00PL08ABA	550 X 393 X 20	0.0284	2	0.0568
6	外紙箱(5)Carton	BX57041027CCBA	570 X 410 X 265	1.0	1	1.0
7						
8						
9						

2. 一整箱總重量 (Total LCD Weight in carton) : 16.87 Kg±10%

3. 單箱數量規格表 (Packaging Specifications and Quantity) :

(1) LCM quantity per box : no per tray	4	x no of tray	5	=	20
(2) Total LCM quantity in carton : quantity per box	20	x no of boxes	6	=	120

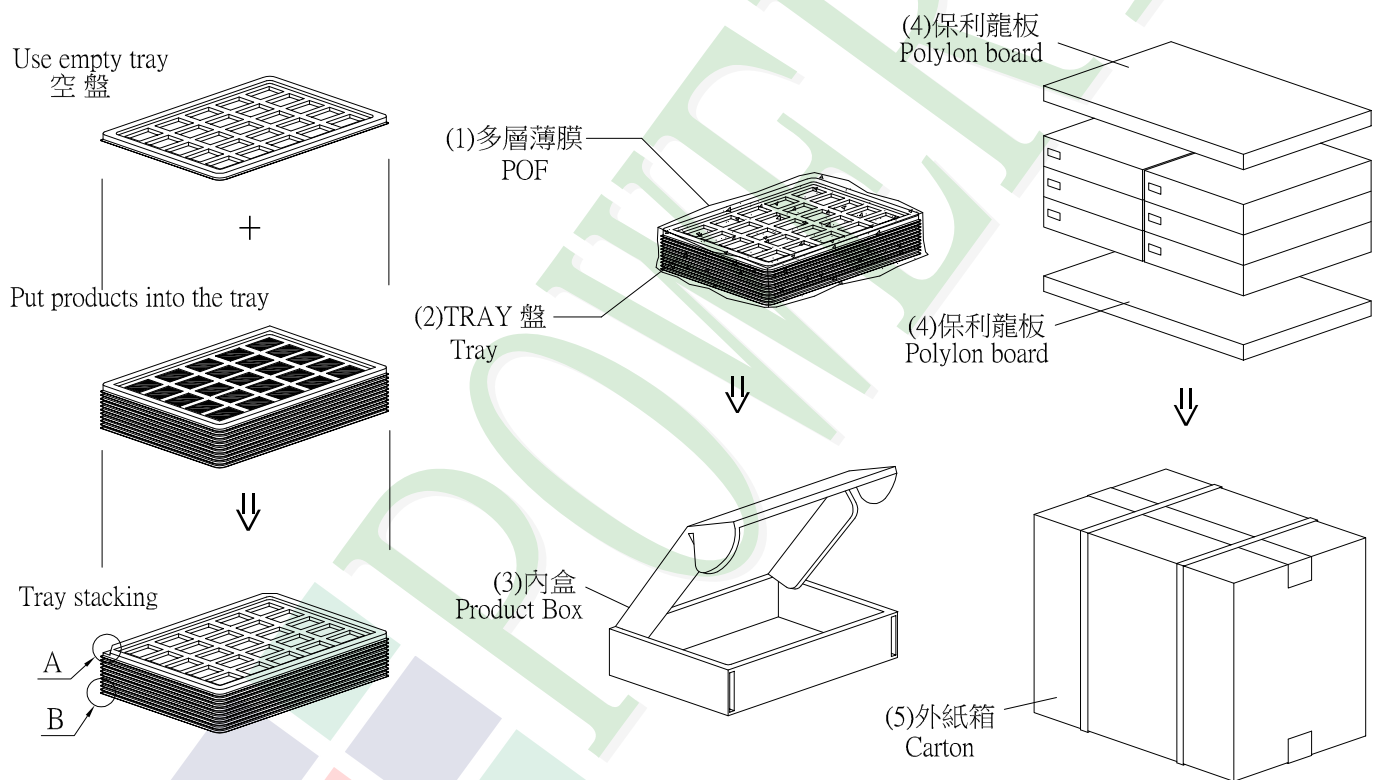

特 記 事 項 (REMARK)

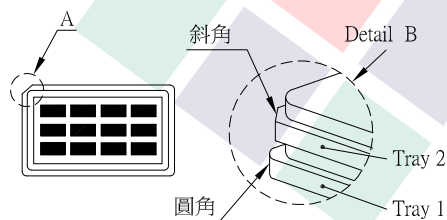

4. TRAY 盤相疊時, 需旋轉180度, 請詳見B視圖
Rotate tray 180 degrees and place on top of stack.
Check the tray stack using Fig. B.