



SPECIFICATIONS

CUSTOMER	:	HCN070
SAMPLE CODE	:	SH320480T009-LAA01
MASS PRODUCTION CODE	:	PH320480T009-LAA01
SAMPLE VERSION	:	01
SPECIFICATIONS EDITION	:	004
DRAWING NO. (Ver.)	:	LMD-PH320480T009-LAA01_001
PACKAGING NO. (Ver.)	:	JPKG-PH320480T009-LAA01_002

Customer Approved

Date:

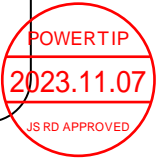

Approved	Checked	Designer
劉進 Jin Liu	陳璐 Lu Chen	王琦 Qi Wang

- Preliminary specification for design input
- Specification for sample approval

POWERTIP TECH. CORP.

Headquarters:
 No.8, 6th Road, Taichung Industrial Park,
 Taichung, Taiwan
 台中市 407 工業區六路 8 號

TEL: 886-4-2355-8168
 FAX: 886-4-2355-8166

E-mail: sales@powertip.com.tw
 Http://www.powertip.com.tw

Contents

1. SPECIFICATIONS

- 1.1 Features
- 1.2 Mechanical Specifications
- 1.3 Absolute Maximum Ratings
- 1.4 DC Electrical Characteristics
- 1.5 Optical Characteristics
- 1.6 Backlight Unit Characteristics

2. MODULE STRUCTURE

- 2.1 Counter Drawing
- 2.2 Interface Pin Description
- 2.3 Timing Characteristics

3. QUALITY ASSURANCE SYSTEM

- 3.1 Quality Assurance Flow Chart
- 3.2 Inspection Specification

4. RELIABILITY TEST

- 4.1 Reliability Test Condition

5. PRECAUTION RELATING PRODUCT HANDLING

- 5.1 Safety
- 5.2 Handling
- 5.3 Storage
- 5.4 Terms of Warranty

Appendix :

- 1. LCM Drawing
- 2. Packaging Specifications

1. SPECIFICATIONS

1.1 Features

<u>Item</u>	<u>Standard Value</u>
Display Type	320 * 3 (RGB) * 480 Dots
LCD Type	a-Si TFT , Normally white, Transmissive type
Screen size(inch)	3.5 inch
Viewing Direction	12 O'clock
Color configuration	RGB-Strip
Interface	Parallel 8080-series MCU Interface (8-bit, 9-bit, 16-bit, and 18-bit) 16/18 RGB Interface Serial Peripheral Interface (SPI Interface)
Other(controller/driver IC)	ST7796S-G5
ROHS	THIS PRODUCT CONFORMS THE ROHS OF PTC Detail information please refer website: http://www.powertip.com.tw/news_detail.php?Key=1&cID=1

Note : For detailed information please refer to IC data sheet : ST7796S-G5

1.2 Mechanical Specifications

<u>Item</u>	<u>Standard Value</u>	<u>Unit</u>
Outline Dimension	55.26(W) x 84.69 (L) x 2.7(H)	mm
Viewing Area	49.96(W) x 74.44(L)	mm
Active Area	48.96 (W) * 73.44 (L)	mm

Note : For detailed information please refer to LCM drawing

1.3 Absolute Maximum Ratings

Item	Symbol	Condition	Min.	Max.	Unit
Supply Voltage	VDD	-	-0.3	+4.6	V
Supply Voltage(I/O)	VDDI	-	-0.3	+4.6	V
Operating Temperature	T _{OP} (Ts)	Note 1	-20	+70	°C
Storage Temperature	T _{ST} (Ta)	Note 2	-30	+80	°C
Storage Humidity	HD	Ta ≤ 60 °C	10	90	%

The absolute maximum rating values of this product are not allowed to be exceeded at any times. Should a module be used with any of the absolute maximum ratings exceeded, the characteristics of the module may not be recovered, or in an extreme case, the module may be permanently destroyed.

Note 1 : Ts is the temperature of panel's surface.

Note 2 : Ta is the ambient temperature of samples.

1.4 DC Electrical Characteristics

GND = 0V, Ta = 25°C

Item	Symbol	Condition	Min.	Typ.	Max.	Unit
Supply Voltage	VDD	-	2.5	2.8	3.3	V
Supply Voltage(I/O)	VDDI	-	1.65	1.8	3.3	V
Input High Voltage	V _{IH}	-	0.7 VDDI	-	VDDI	V
Input Low Voltage	V _{IL}	-	GND	-	0.3 VDDI	V
Output High Voltage	V _{OH}	I _{OH} =-0.1mA	0.8*VDDI	-	VDDI	V
Output Low Voltage	V _{OL}	I _{OL} =+0.1mA	GND	-	0.2*VDDI	V
Supply Current	IDD	-	-	15	20	mA

1.5 Optical Characteristics

VDD=VDDI = 3.3V, Ta=25°C

Item	Symbol	Condition	Min.	Typ.	Max.	unit	
Response time	Tr+ Tf	Ta = 25°C θX, θY = 0°	-	25	38	ms	Note2
Viewing angle	Top	θY+	-	60	-	Deg.	Note4
	Bottom	θY-	-	60	-		
	Left	θX-	-	60	-		
	Right	θX+	-	60	-		
Contrast ratio	CR	Ta = 25°C θX, θY = 0°	500	600	-	-	Note3
Color of CIE Coordinate	White	X	0.24	0.29	0.34	-	Note1
		Y	0.27	0.32	0.37		
	Red	X	0.55	0.60	0.65		
		Y	0.30	0.35	0.40		
	Green	X	0.28	0.33	0.38		
		Y	0.57	0.62	0.67		
	Blue	X	0.09	0.14	0.19		
		Y	0.02	0.07	0.12		
Average Brightness (With LCD) *1	IV	IF=120 mA	350	430	-	cd/m ²	
Uniformity (With LCD) *2	△B	IF=120 mA	70	-	-	%	

Note 1:

*1 : $\Delta B = B(\min) / B(\max) * 100\%$

*2 : Measurement Condition for Optical Characteristics:

a : Environment: 25°C ± 5°C / 60 ± 20% R.H , no wind , dark room below 10 Lux at typical lamp current and typical operating frequency.

b : Measurement Distance: 500 ± 50 mm , (θ = 0°)

c : Equipment: TOPCON BM-7 fast , (field 1°) , after 10 minutes operation.

d : The uncertainty of the C.I.E coordinate measurement ± 0.01 , Average Brightness ± 4%

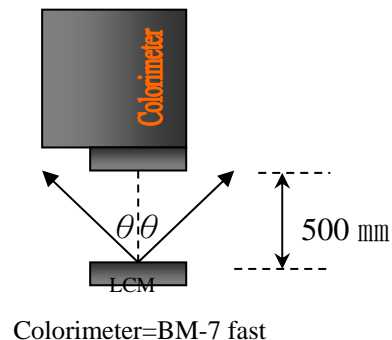
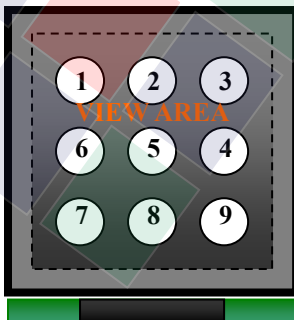

To be measured at the center area of panel with a viewing cone of 1° by Topcon luminance meter BM-7, after 10 minutes operation (module)

Note2: Definition of response time:

The output signals of photo detector are measured when the input signals are changed from “black” to “white”(falling time) and from “white” to “black”(rising time), respectively. The response time is defined as the time interval between the 10% and 90% of Amplitudes.

Refer to figure as below:

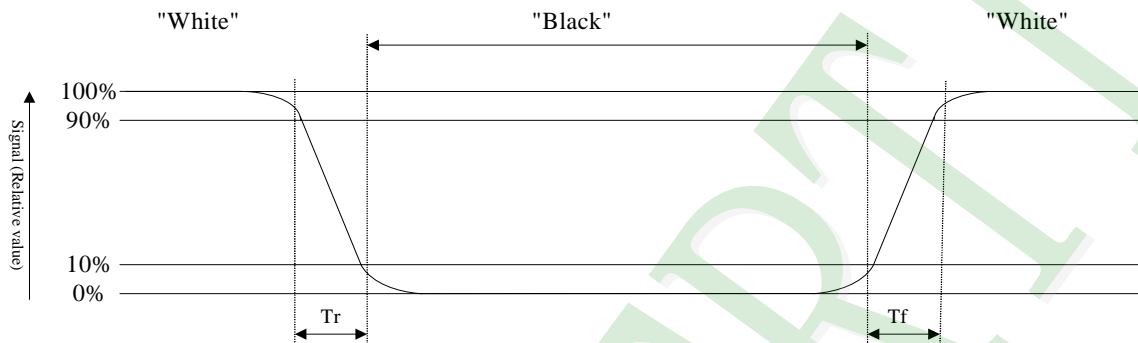

Note3: Definition of contrast ratio:

Contrast ratio is calculated with the following formula

Photo detector output when LCD is at “White” state

Contrast ratio (CR) = $\frac{\text{Photo detector output when LCD is at “White” state}}{\text{Photo detector output when LCD is at “Black” state}}$

Photo detector output when LCD is at “Black” state

Note4: Definition of viewing angle:

Refer to figure as below:

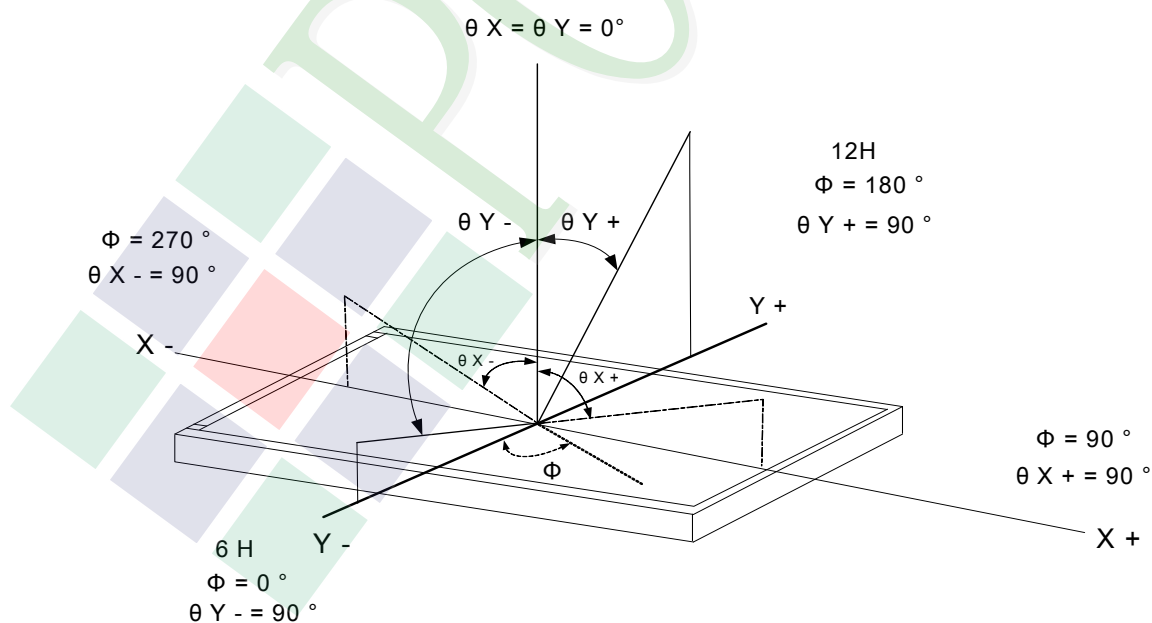

1.6 Backlight Unit Characteristics

Maximum Ratings

Item	Symbol	Conditions	Min.	Max.	Unit
Forward Current	IF	Ta =25°C	-	150	mA
Reverse Voltage	VR	Ta =25°C	-	4	V
Power Dissipation	PD	Ta =25°C	-	540	mW

Electrical / Optical Characteristics

Item	Symbol	Conditions	Min.	Typ.	Max.	Unit
Forward Voltage	VF	IF= 120 mA	2.8	3.2	3.6	V
Average Brightness (Without LCD)	IV		6000	7200	-	cd/m ²
CIE Color Coordinate (Without LCD)	X		0.26	0.28	0.32	-
	Y		0.26	0.28	0.32	
Color	White					

Circuit diagram:

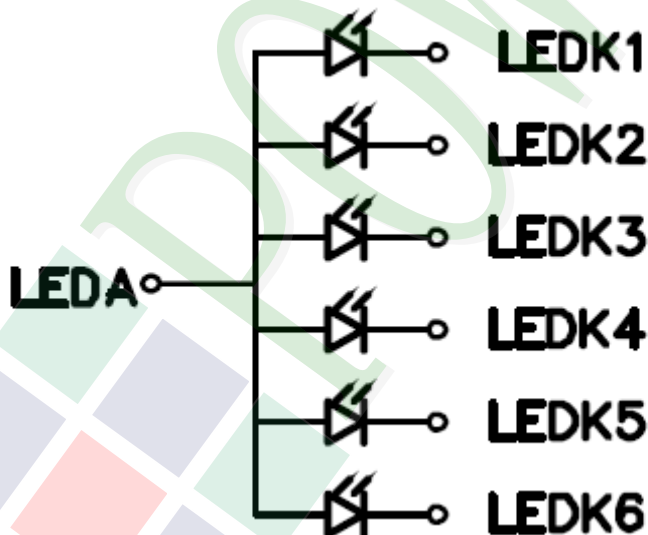

Other Description

Item	Conditions	Description
Life Time	Ta =25°C IF= 120 mA	20000 hrs

2. MODULE STRUCTURE

2.1 Counter Drawing

2.1.1 LCM Mechanical Diagram

* See Appendix

2.1.2 Block Diagram

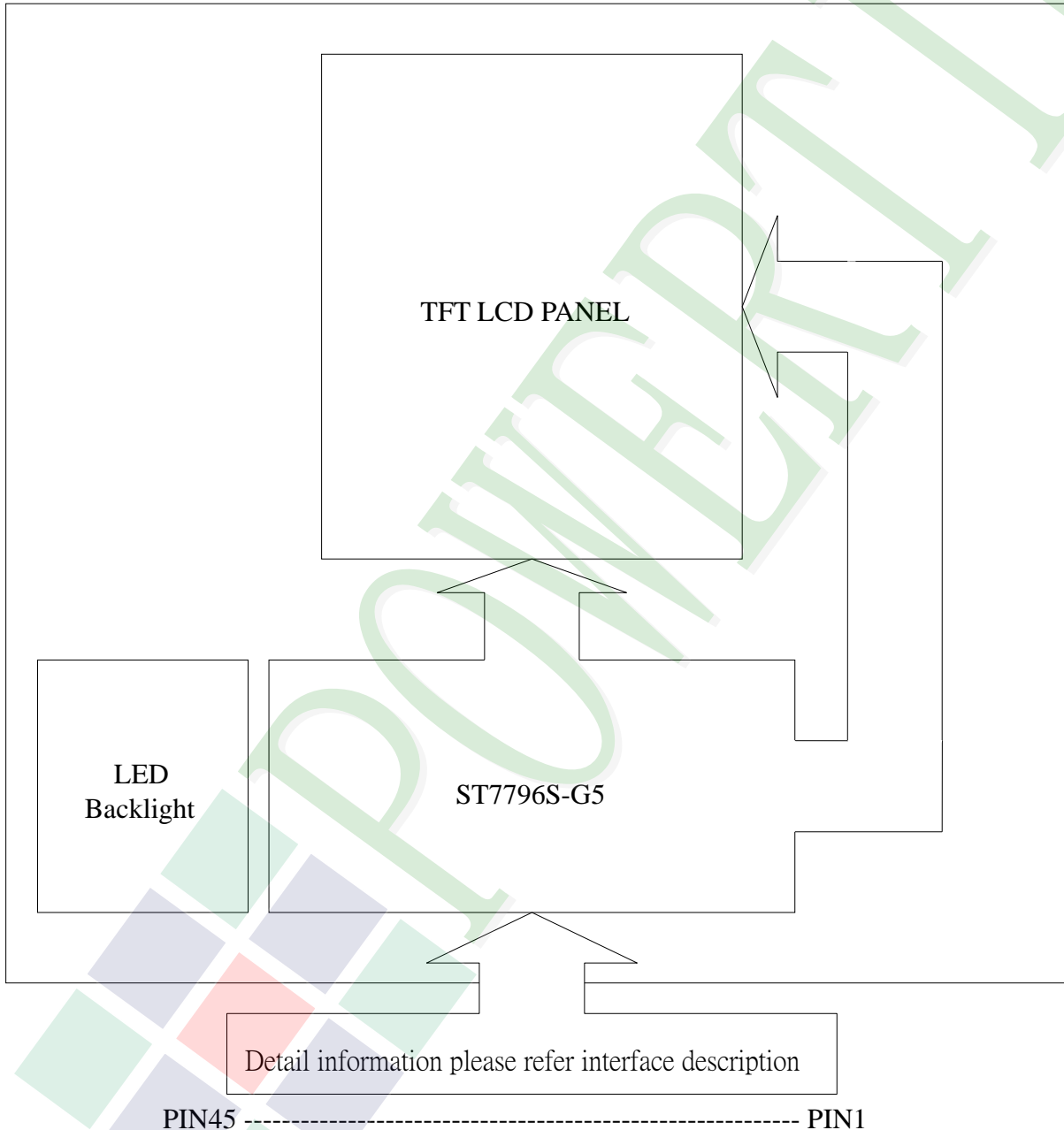

2.2 Interface Pin Description

Pin No.	Symbol	Function
1	LEDK6-	Power supply for LED Backlight cathode input
2	LEDK5-	
3	LEDK4-	
4	LEDK3-	
5	LEDK2-	
6	LEDK1-	
7	LEDA	Power supply for LED Backlight anode input
8	GND	Ground
9	VDD	Power supply for analog and booster circuits
10	VDDI	Power supply for I/O system. VDDI must be lower than or equal to VDD.
11	TE	Tearing Effect output signal. Leave the pin open when not in use.
12	CSX	Chip selection pin. Low-active. If not used, please fix this pin at VDDI or DGND level.
13	DCX	Display data/command selection (RS) pin in MCU interface. DCX='1': display data or parameter. DCX='0': register index / command. If not used, please fix this pin at VDDI or DGND level.
14	WRX/SCL	Write enable in MCU parallel interface. In SPI mode, this pin is used as SCL. If not used, please fix this pin at VDDI or DGND level.
15	RDX	Read enable in 8080 MCU parallel interface. Low-active. If not used, please fix this pin at VDDI or DGND level.
16	SDA	SPI interface input/output pin. The data is latched on the rising edge of the SCL signal. If not used, please fix this pin at VDDI or DGND level.
17	SDO	SPI interface output pin. The data is outputted on the falling edge of the SCL signal. If not used, please fix this pin at floating.
18	DB0	Data bus Fix to GND level when not in use.
19	DB1	
20	DB2	
21	DB3	

Pin No.	Symbol	Function																																			
22	DB4	Data bus Fix to GND level when not in use. <table border="1" data-bbox="533 479 1382 884" style="margin: 10px auto;"> <thead> <tr> <th>IM2</th> <th>IM1</th> <th>IM0</th> <th>MPU Interface Mode</th> <th>Data pin</th> </tr> </thead> <tbody> <tr> <td>0</td> <td>0</td> <td>0</td> <td>8080 18-bit Interface</td> <td>DB[17:0]</td> </tr> <tr> <td>0</td> <td>0</td> <td>1</td> <td>8080 9-bit Interface</td> <td>DB[8:0]</td> </tr> <tr> <td>0</td> <td>1</td> <td>0</td> <td>8080 16-bit Interface</td> <td>DB[15:0]</td> </tr> <tr> <td>0</td> <td>1</td> <td>1</td> <td>8080 8-bit Interface</td> <td>DB[7:0],</td> </tr> <tr> <td>1</td> <td>0</td> <td>1</td> <td>3SPI</td> <td>SDA, SDO</td> </tr> <tr> <td>1</td> <td>1</td> <td>1</td> <td>4Line SPI</td> <td>SDA, SDO</td> </tr> </tbody> </table>	IM2	IM1	IM0	MPU Interface Mode	Data pin	0	0	0	8080 18-bit Interface	DB[17:0]	0	0	1	8080 9-bit Interface	DB[8:0]	0	1	0	8080 16-bit Interface	DB[15:0]	0	1	1	8080 8-bit Interface	DB[7:0],	1	0	1	3SPI	SDA, SDO	1	1	1	4Line SPI	SDA, SDO
IM2	IM1		IM0	MPU Interface Mode	Data pin																																
0	0		0	8080 18-bit Interface	DB[17:0]																																
0	0		1	8080 9-bit Interface	DB[8:0]																																
0	1		0	8080 16-bit Interface	DB[15:0]																																
0	1		1	8080 8-bit Interface	DB[7:0],																																
1	0		1	3SPI	SDA, SDO																																
1	1		1	4Line SPI	SDA, SDO																																
23	DB5																																				
24	DB6																																				
25	DB7																																				
26	DB8																																				
27	DB9																																				
28	DB10																																				
29	DB11																																				
30	DB12																																				
31	DB13																																				
32	DB14																																				
33	DB15																																				
34	DB16																																				
35	DB17																																				
36	ENABLE	Data enable signal for RGB interface operation. If not used, please fix this pin at VDDI or DGND.																																			
37	DOTLCK	Dot clock signal for RGB interface operation. If not used, please fix this pin at VDDI or DGND.																																			
38	HSYNC	Horizontal synchronizing input signal for RGB interface operation. If not used, please fix to VDDI or DGND.																																			
39	GND	Ground																																			
40	VSYNC	Vertical synchronizing input signal for RGB interface operation. If not used, please fix to the VDDI or DGND.																																			
41	RESET	This signal will reset the device and it must be applied to properly initialize the chip. Signal is active low.																																			
42	IM2	The MCU interface mode select.																																			
43	IM1																																				
44	IM0																																				
45	GND	Ground																																			

2.2.1 Refer Initial Code : (RGB interface)

```
void LCD_Init(void)
{
    LCD_WR_REG (0x11)

    LCD_WR_REG (0xF0)
    LCD_WR_REG (0xC3)

    LCD_WR_REG (0xF0)
    LCD_WR_REG (0x96)

    LCD_WR_REG (0x36)
    LCD_WR_REG (0x48)

    LCD_WR_REG (0xB4)
    LCD_WR_REG (0x01)

    LCD_WR_REG (0xB6)
    LCD_WR_REG (0x20)
    LCD_WR_REG (0x02)
    LCD_WR_REG (0x3B)

    LCD_WR_REG (0xE8)
    LCD_WR_REG (0x40)
    LCD_WR_REG (0x8A)
    LCD_WR_REG (0x00)
    LCD_WR_REG (0x00)
    LCD_WR_REG (0x29)
    LCD_WR_REG (0x19)
    LCD_WR_REG (0xA5)
    LCD_WR_REG (0x33)

    LCD_WR_REG (0xC1)
    LCD_WR_REG (0x06)

    LCD_WR_REG (0xC2)
    LCD_WR_REG (0xA7)

    LCD_WR_REG (0xC5)
    LCD_WR_REG (0x18)

    LCD_WR_REG (0xE0)
    LCD_WR_REG (0xF0)
    LCD_WR_REG (0x09)
    LCD_WR_REG (0x0B)
    LCD_WR_REG (0x06)
    LCD_WR_REG (0x04)
    LCD_WR_REG (0x15)
    LCD_WR_REG (0x2F)
    LCD_WR_REG (0x54)
    LCD_WR_REG (0x42)
    LCD_WR_REG (0x3C)
```

LCD_WR_REG (0x17)
LCD_WR_REG (0x14)
LCD_WR_REG (0x18)
LCD_WR_REG (0x1B)

LCD_WR_REG (0xE1)
LCD_WR_REG (0xF0)
LCD_WR_REG (0x09)
LCD_WR_REG (0x0B)
LCD_WR_REG (0x06)
LCD_WR_REG (0x04)
LCD_WR_REG (0x03)
LCD_WR_REG (0x2D)
LCD_WR_REG (0x43)
LCD_WR_REG (0x42)
LCD_WR_REG (0x3B)
LCD_WR_REG (0x16)
LCD_WR_REG (0x14)
LCD_WR_REG (0x17)
LCD_WR_REG (0x1B)

LCD_WR_REG (0xF0)
LCD_WR_REG (0x3C)

LCD_WR_REG (0xF0)
LCD_WR_REG (0x69)

LCD_WR_REG (0x29)

}

2.3 Timing Characteristics

8080 Series MCU Parallel Interface Characteristics: 18/16/9/8-bit Bus

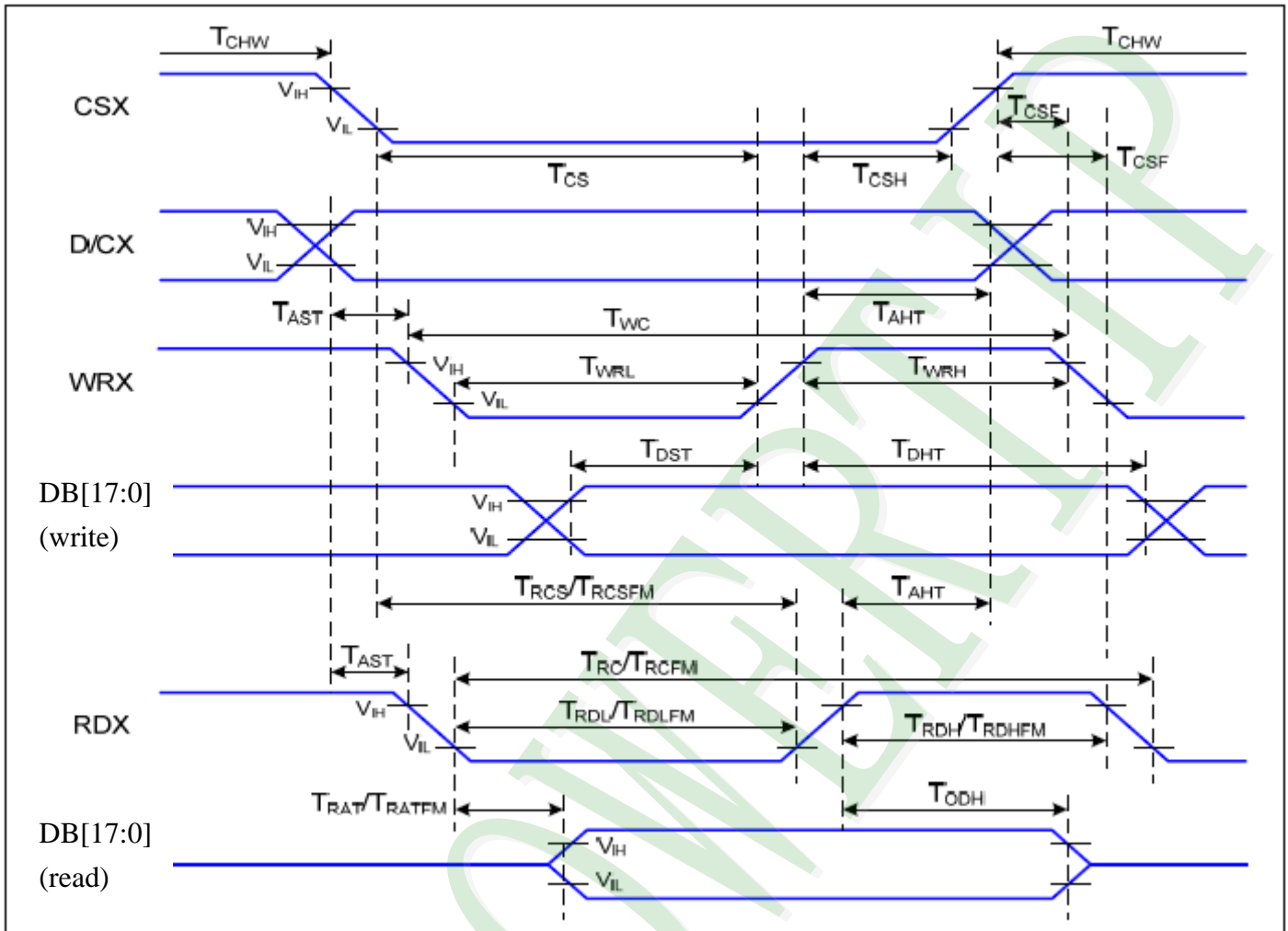

Signal	Symbol	Parameter	Min	Max	Unit	Description
D/CX	T_{AST}	Address setup time	0		ns	-
	T_{AHT}	Address hold time (Write/Read)	10		ns	
CSX	T_{CHW}	Chip select "H" pulse width	0		ns	-
	T_{CS}	Chip select setup time (Write)	15		ns	
	T_{RCS}	Chip select setup time (Read ID)	45		ns	
	T_{RCSFM}	Chip select setup time (Read FM)	355		ns	
	T_{CSF}	Chip select wait time (Write/Read)	10		ns	
	T_{CSH}	Chip select hold time	10		ns	
WRX	T_{WC}	Write cycle	66		ns	-
	T_{WRH}	Control pulse "H" duration	15		ns	

	T_{WRL}	Control pulse "L" duration	15		ns	
RDX (ID)	T_{RC}	Read cycle (ID)	160		ns	When read ID data
	T_{RDH}	Control pulse "H" duration (ID)	90		ns	
	T_{RDL}	Control pulse "L" duration (ID)	45		ns	
RDX (FM)	T_{RCFM}	Read cycle (FM)	450		ns	When read from frame memory
	T_{RDHFM}	Control pulse "H" duration (FM)	90		ns	
	T_{RDLFM}	Control pulse "L" duration (FM)	355		ns	
DB[17:0]	T_{DST}	Data setup time	10		ns	For CL=30pF
	T_{DHT}	Data hold time	10		ns	
	T_{RAT}	Read access time (ID)	-	40	ns	
	T_{RATFM}	Read access time (FM)	-	340	ns	
	T_{ODH}	Output disable time	20	80	ns	

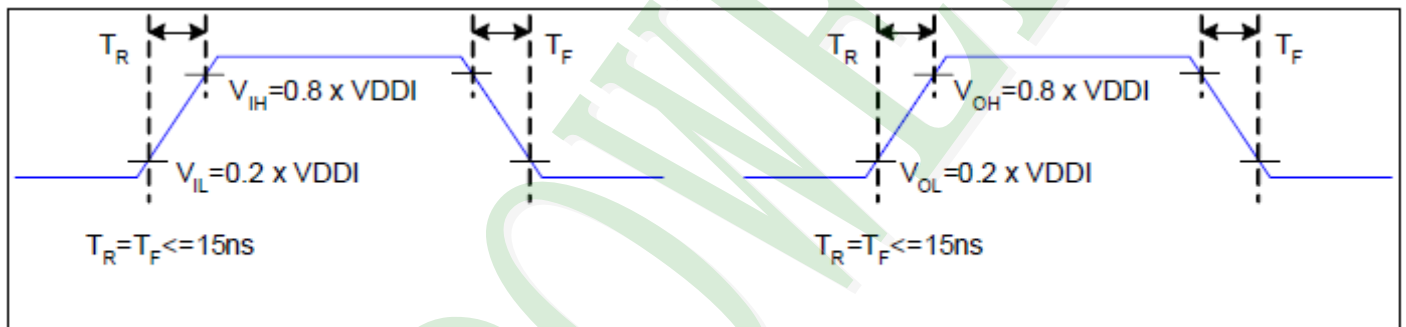

Rising and Falling Timing for I/O Signal

Note: The rising time and falling time (T_r , T_f) of input signal and fall time are specified at 15 ns or less. Logic high and low levels are specified as 20% and 80% of VDDI for Input signals.

3-SPI Serial Data Transfer Interface Characteristics:

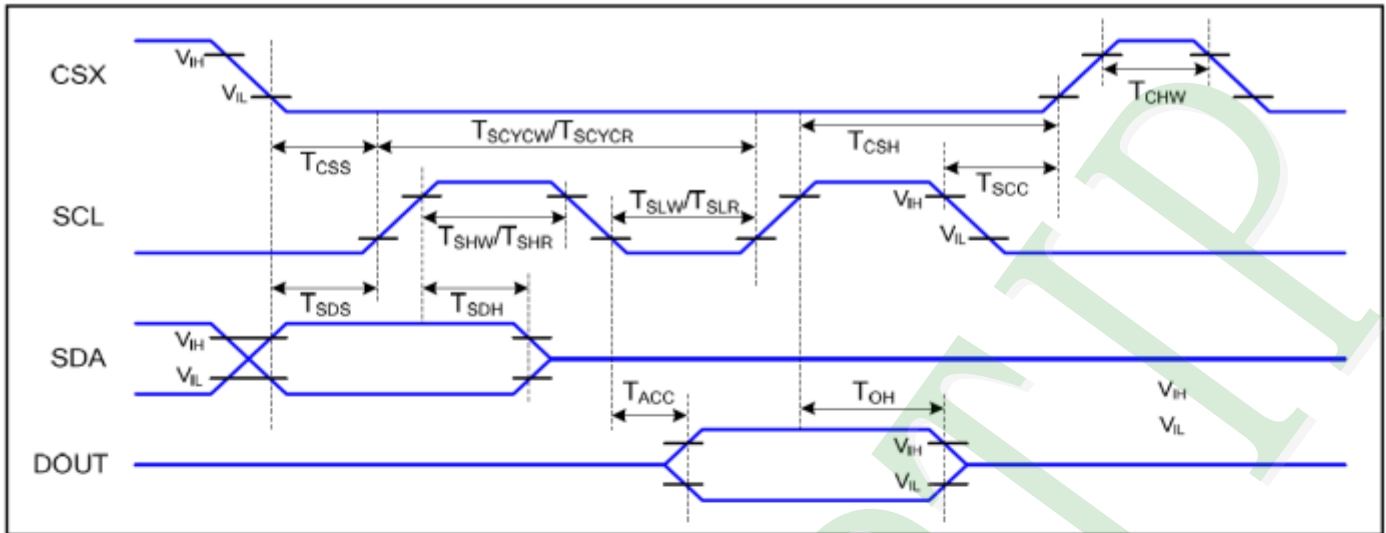

3-SPI Interface Timing Characteristics

VDDI=1.8V, VDDA=2.8V, AGND=DGND=0V, Ta=25 °C

Signal	Symbol	Parameter	Min	Max	Unit	Description
CSX	T _{CSS}	Chip select setup time (write)	15		ns	
	T _{CSH}	Chip select hold time (write)	15		ns	
	T _{CSS}	Chip select setup time (read)	60		ns	
	T _{SCC}	Chip select hold time (read)	65		ns	
	T _{CHW}	Chip select "H" pulse width	40		ns	
SCL	T _{SCYCW}	Serial clock cycle (Write)	66		ns	
	T _{SHW}	SCL "H" pulse width (Write)	15		ns	
	T _{SLW}	SCL "L" pulse width (Write)	15		ns	
	T _{SCYCR}	Serial clock cycle (Read)	150		ns	
	T _{SHR}	SCL "H" pulse width (Read)	60		ns	
	T _{SLR}	SCL "L" pulse width (Read)	60		ns	
SDA (DIN)	T _{SDS}	Data setup time	10		ns	
	T _{SDH}	Data hold time	10		ns	
DOUT	T _{ACC}	Access time	10	50	ns	For maximum CL=30pF
	T _{OH}	Output disable time	15	50	ns	For minimum CL=8pF

3-SPI Interface Characteristics

4-SPI Serial Data Transfer Interface Characteristics:

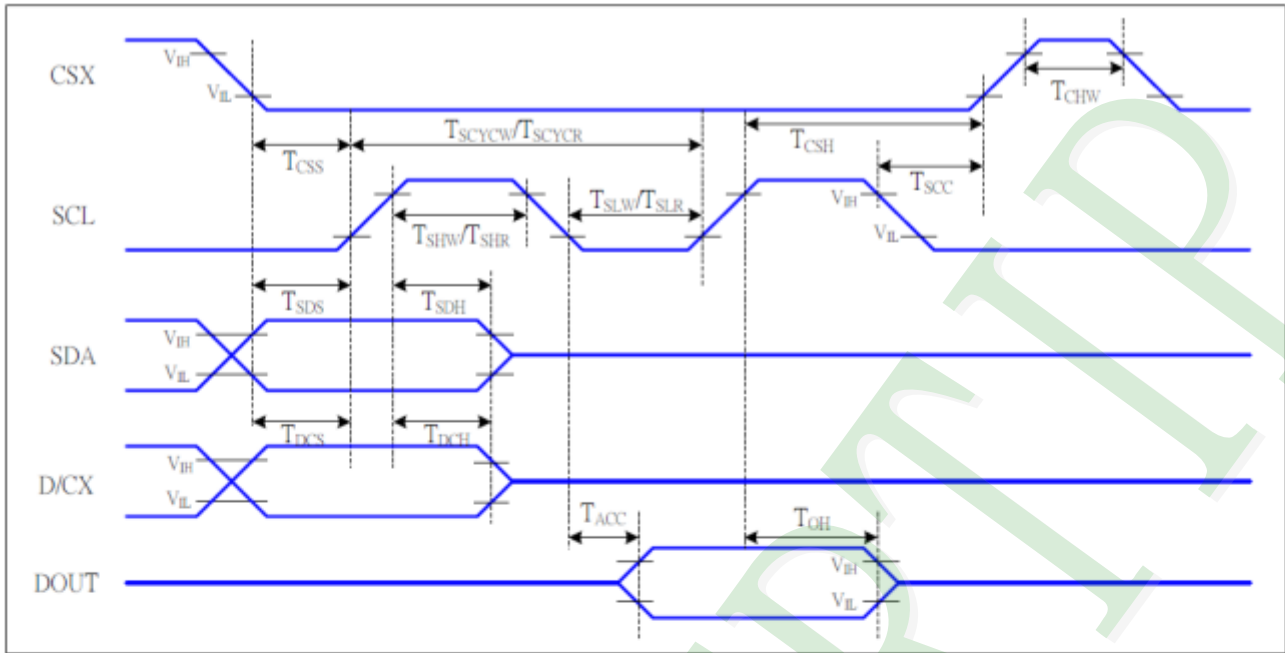

4-SPI Interface Timing Characteristics

V_{DDI}=1.8V, V_{DDA}=2.8V, A_{GND}=D_{GND}=0V, T_a=25 °C

Signal	Symbol	Parameter	MIN	MAX	Unit	Description
CSX	T _{CSS}	Chip select setup time (write)	15		ns	
	T _{CSH}	Chip select hold time (write)	15		ns	
	T _{CSS}	Chip select setup time (read)	60		ns	
	T _{SCC}	Chip select hold time (read)	65		ns	
	T _{CHW}	Chip select "H" pulse width	40		ns	
SCL	T _{SCYCW}	Serial clock cycle (Write)	66		ns	-write command & data ram
	T _{SHW}	SCL "H" pulse width (Write)	15		ns	
	T _{SLW}	SCL "L" pulse width (Write)	15		ns	
	T _{SCYCR}	Serial clock cycle (Read)	150		ns	-read command & data ram
	T _{SHR}	SCL "H" pulse width (Read)	60		ns	
	T _{SLR}	SCL "L" pulse width (Read)	60		ns	
D/CX	T _{DCS}	D/CX setup time	10		ns	
	T _{DCH}	D/CX hold time	10		ns	
SDA (DIN)	T _{SDS}	Data setup time	10		ns	
	T _{SDH}	Data hold time	10		ns	
DOUT	T _{ACC}	Access time	10	50	ns	For maximum CL=30pF
	T _{OH}	Output disable time	15	50	ns	For minimum CL=8pF

RGB Interface Characteristics:

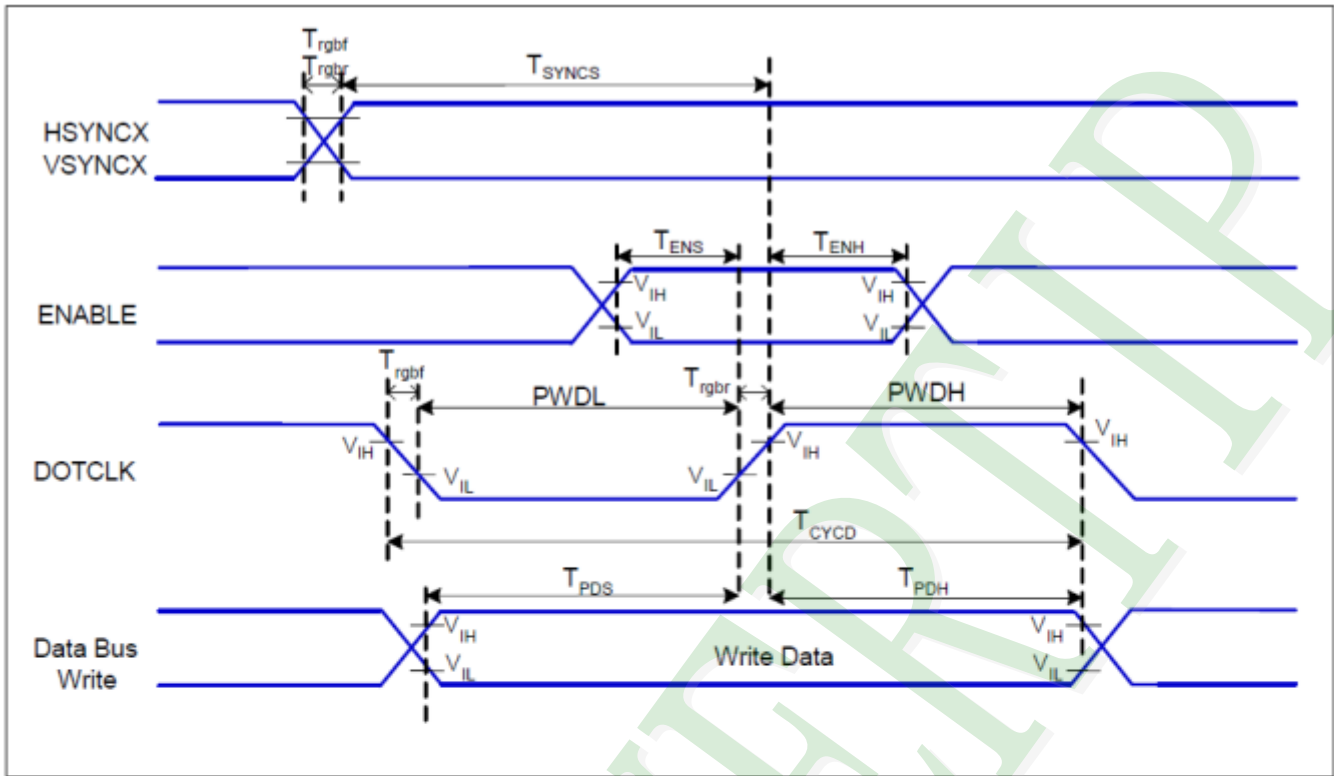

VDDI=1.8V, VDDA=2.8V, AGND=DGND=0V, Ta=25°C

Signal	Symbol	Parameter	MIN	MAX	Unit	Description
HSYNC, VSYNC	T_{SYNCS}	VSYNC, HSYNC Setup Time	15	-	ns	
ENABLE	T_{ENS}	Enable Setup Time	15	-	ns	
	T_{ENH}	Enable Hold Time	15	-	ns	
DOTCLK	PWDH	DOTCLK High-level Pulse Width	30	-	ns	
	PWDL	DOTCLK Low-level Pulse Width	30	-	ns	
	T_{CYCD}	DOTCLK Cycle Time	66	-	ns	
	Trghr, Trghf	DOTCLK Rise/Fall time	-	15	ns	
DB	T_{PDS}	PD Data Setup Time	15	-	ns	
	T_{PDH}	PD Data Hold Time	15	-	ns	

RGB Interface Timing Characteristics

3. QUALITY ASSURANCE SYSTEM

3.1 Quality Assurance Flow Chart

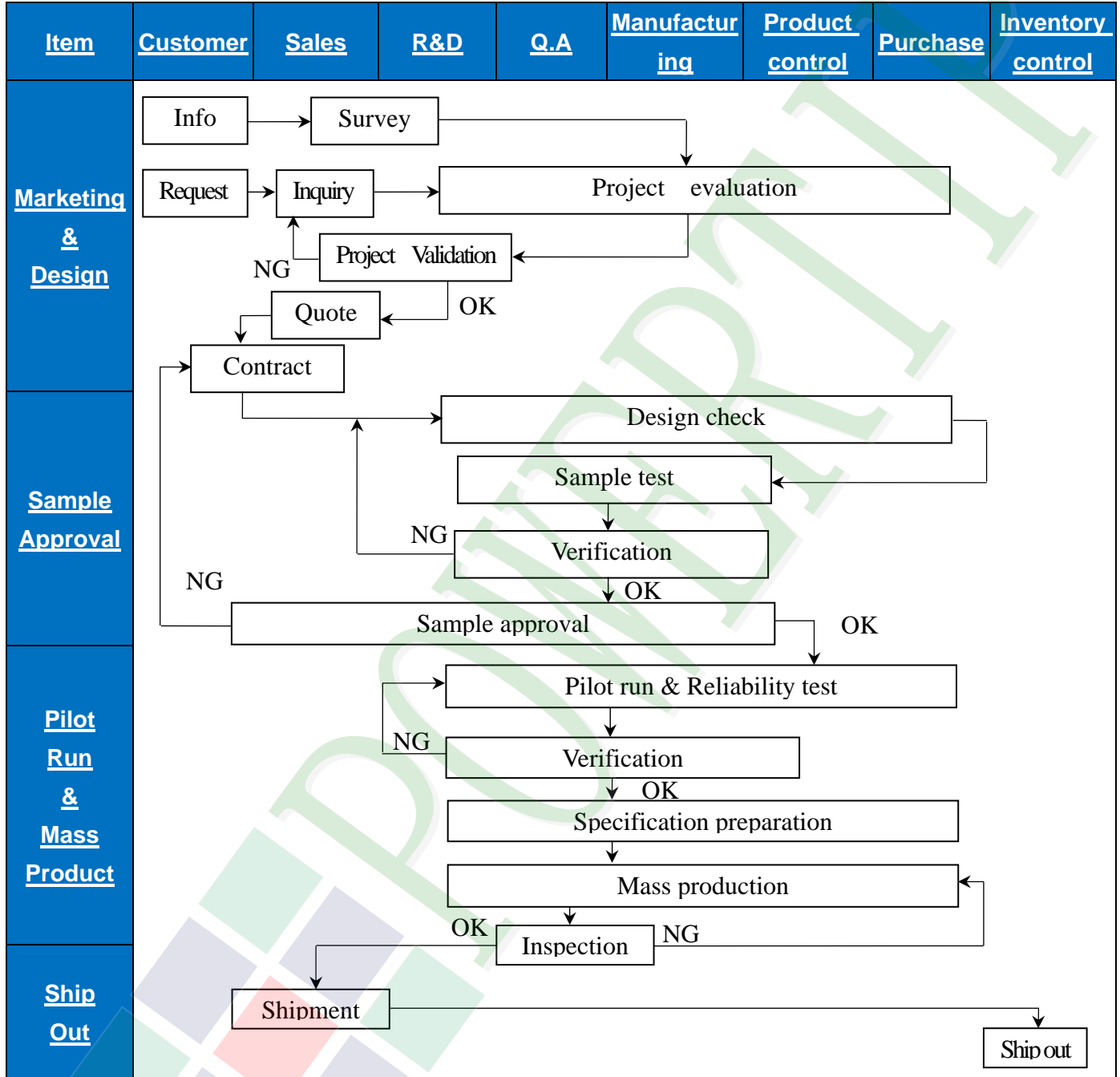

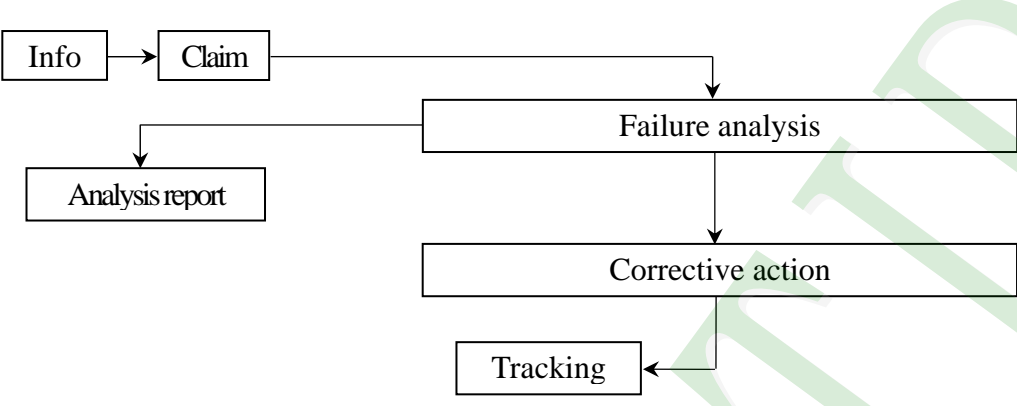
<u>Item</u>	<u>Customer</u>	<u>Sales</u>	<u>R&D</u>	<u>Q.A</u>	<u>Manufacturing</u>	<u>Product control</u>	<u>Purchase</u>	<u>Inventory control</u>
<u>Sales Service</u>	 <pre> graph TD Info[Info] --> Claim[Claim] Claim --> Failure[Failure analysis] Failure --> Report[Analysis report] Failure --> Action[Corrective action] Action --> Tracking[Tracking] </pre>							
<u>Q.A Activity</u>	1. ISO 9001 Maintenance Activities 3. Equipment calibration 5. Standardization Management				2. Process improvement proposal 4. Education And Training Activities			

3.2. Inspection Specification

- ◆Scope : The document shall be applied to TFT-LCD Module for less than 3.5" (Ver.B01).
- ◆Inspection Standard : MIL-STD-105E Table Normal Inspection Single Sampling Level II.
- ◆Equipment : Gauge 、MIL-STD 、Powertip Tester 、Sample
- ◆Defect Level : Major Defect AQL : 0.4 ; Minor Defect AQL : 1.5
- ◆OUT Going Defect Level: Sampling.
- ◆Standard of the product appearance test :

a. Manner of appearance test :

- (1). The test best be under 20W×2 fluorescent light (about 300lux ~500lux)
 - ， and distance of view must be at 30~40 cm.
- (2). The test direction is base on about around 45° of vertical line.

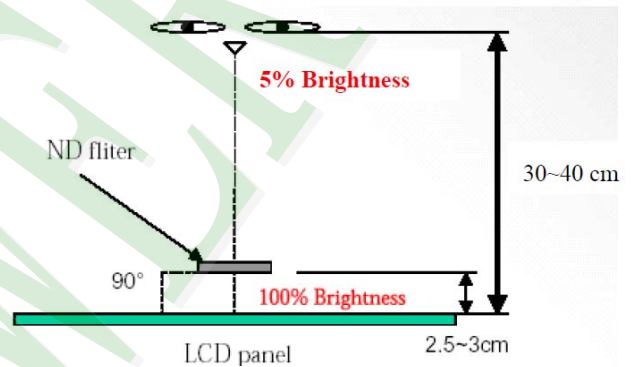
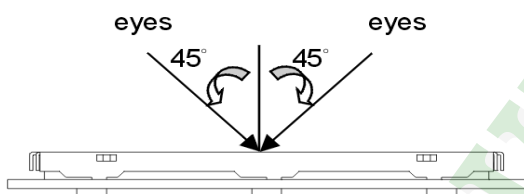

(3). Definition of area.

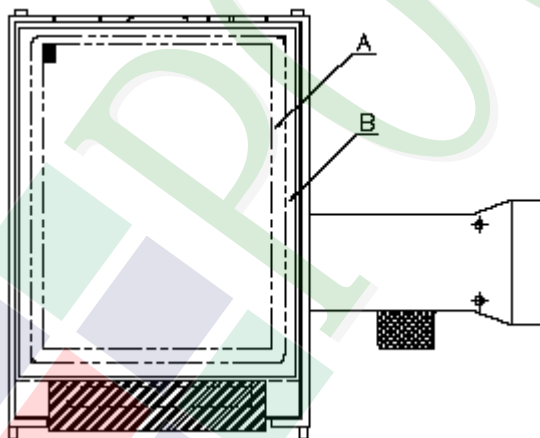

A area : viewing area

B area : Outside of viewing area

(4). Standard of inspection : (Unit : mm)

◆ Specification For TFT-LCD Module Less Than 3.5" :
(Ver.B01)

<u>NO</u>	<u>Item</u>	<u>Criterion</u>	<u>Level</u>										
01	Product condition	1. 1 The part number is inconsistent with work order of production.	Major										
		1. 2 Mixed product types.	Major										
		1. 3 Assembled in inverse direction.	Major										
02	Quantity	2. 1 The quantity is inconsistent with work order of production.	Major										
03	Outline dimension	3. 1 Product dimension and structure must conform to structure diagram.	Major										
04	Electrical Testing	4. 1 Missing line character and icon.	Major										
		4. 2 No function or no display.	Major										
		4. 3 Display malfunction.	Major										
		4. 4 LCD viewing angle defect.	Major										
		4. 5 Current consumption exceeds product specifications.	Major										
		4. 6 Mura cannot be seen through 5% ND filter at 50% Gray , should be judged by the viewing angle of 90 degree.	Minor										
05	Dot defect (Bright dot 、 Dark dot) On -display	<table border="1"> <thead> <tr> <th><u>Item</u></th> <th><u>Acceptance (Q'ty)</u></th> </tr> </thead> <tbody> <tr> <td>Bright Dot</td> <td>≤ 2</td> </tr> <tr> <td>Dark Dot</td> <td>≤ 3</td> </tr> <tr> <td>Joint Dot</td> <td>≤ 2</td> </tr> <tr> <td>Total</td> <td>≤ 3</td> </tr> </tbody> </table>	<u>Item</u>	<u>Acceptance (Q'ty)</u>	Bright Dot	≤ 2	Dark Dot	≤ 3	Joint Dot	≤ 2	Total	≤ 3	Minor
		<u>Item</u>	<u>Acceptance (Q'ty)</u>										
Bright Dot	≤ 2												
Dark Dot	≤ 3												
Joint Dot	≤ 2												
Total	≤ 3												
5. 1 Inspection pattern : full white , full black , Red , Green and blue screens. 5. 2 It is defined as dot defect if defect area $> 1/2$ dot. 5. 3 The distance between two dot defect ≥ 5 mm. 5. 4 Bright dot that can not be seen through 5% ND filter.													

◆ Specification For TFT-LCD Module Less Than 3.5" :

(Ver.B01)

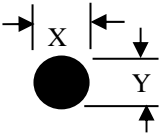
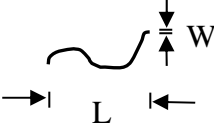
NO	Item	Criterion	Level																																							
06	<p>Black or white dot、scratch、contamination</p> <p>Round type</p>  <p>$\Phi = (x + y) / 2$</p> <p>Line type</p> 	<p>6.1 Round type (Non-display or display) :</p> <table border="1" data-bbox="545 421 1324 873"> <thead> <tr> <th rowspan="2">Dimension (diameter : Φ)</th> <th colspan="2">Acceptance (Q'ty)</th> </tr> <tr> <th>A area</th> <th>B area</th> </tr> </thead> <tbody> <tr> <td>$\Phi \leq 0.15$</td> <td>Ignore</td> <td rowspan="4">Ignore</td> </tr> <tr> <td>$0.15 < \Phi \leq 0.20$</td> <td>2</td> </tr> <tr> <td>$0.20 < \Phi \leq 0.30$</td> <td>2</td> </tr> <tr> <td>$\Phi > 0.30$</td> <td>0</td> </tr> <tr> <td>Total</td> <td>3</td> <td></td> </tr> </tbody> </table> <p>6.2 Line type(Non-display or display) :</p> <table border="1" data-bbox="526 994 1343 1406"> <thead> <tr> <th colspan="2">Dimension</th> <th colspan="2">Acceptance (Q'ty)</th> </tr> <tr> <th>Length (L)</th> <th>Width (W)</th> <th>A area</th> <th>B area</th> </tr> </thead> <tbody> <tr> <td>---</td> <td>$W \leq 0.03$</td> <td>Ignore</td> <td rowspan="3">Ignore</td> </tr> <tr> <td>$L \leq 5.0$</td> <td>$0.03 < W \leq 0.05$</td> <td>3</td> </tr> <tr> <td>---</td> <td>$W > 0.05$</td> <td>As round type</td> </tr> <tr> <td colspan="2">Total</td> <td>3</td> <td></td> </tr> </tbody> </table>	Dimension (diameter : Φ)	Acceptance (Q'ty)		A area	B area	$\Phi \leq 0.15$	Ignore	Ignore	$0.15 < \Phi \leq 0.20$	2	$0.20 < \Phi \leq 0.30$	2	$\Phi > 0.30$	0	Total	3		Dimension		Acceptance (Q'ty)		Length (L)	Width (W)	A area	B area	---	$W \leq 0.03$	Ignore	Ignore	$L \leq 5.0$	$0.03 < W \leq 0.05$	3	---	$W > 0.05$	As round type	Total		3		Minor
Dimension (diameter : Φ)	Acceptance (Q'ty)																																									
	A area	B area																																								
$\Phi \leq 0.15$	Ignore	Ignore																																								
$0.15 < \Phi \leq 0.20$	2																																									
$0.20 < \Phi \leq 0.30$	2																																									
$\Phi > 0.30$	0																																									
Total	3																																									
Dimension		Acceptance (Q'ty)																																								
Length (L)	Width (W)	A area	B area																																							
---	$W \leq 0.03$	Ignore	Ignore																																							
$L \leq 5.0$	$0.03 < W \leq 0.05$	3																																								
---	$W > 0.05$	As round type																																								
Total		3																																								
07	Polarizer Bubble	<table border="1" data-bbox="536 1460 1334 1872"> <thead> <tr> <th rowspan="2">Dimension (diameter : Φ)</th> <th colspan="2">Acceptance (Q'ty)</th> </tr> <tr> <th>A area</th> <th>B area</th> </tr> </thead> <tbody> <tr> <td>$\Phi \leq 0.20$</td> <td>Ignore</td> <td rowspan="3">Ignore</td> </tr> <tr> <td>$0.20 < \Phi \leq 0.50$</td> <td>3</td> </tr> <tr> <td>$\Phi > 0.50$</td> <td>0</td> </tr> <tr> <td>Total</td> <td>3</td> <td></td> </tr> </tbody> </table>	Dimension (diameter : Φ)	Acceptance (Q'ty)		A area	B area	$\Phi \leq 0.20$	Ignore	Ignore	$0.20 < \Phi \leq 0.50$	3	$\Phi > 0.50$	0	Total	3		Minor																								
Dimension (diameter : Φ)	Acceptance (Q'ty)																																									
	A area	B area																																								
$\Phi \leq 0.20$	Ignore	Ignore																																								
$0.20 < \Phi \leq 0.50$	3																																									
$\Phi > 0.50$	0																																									
Total	3																																									

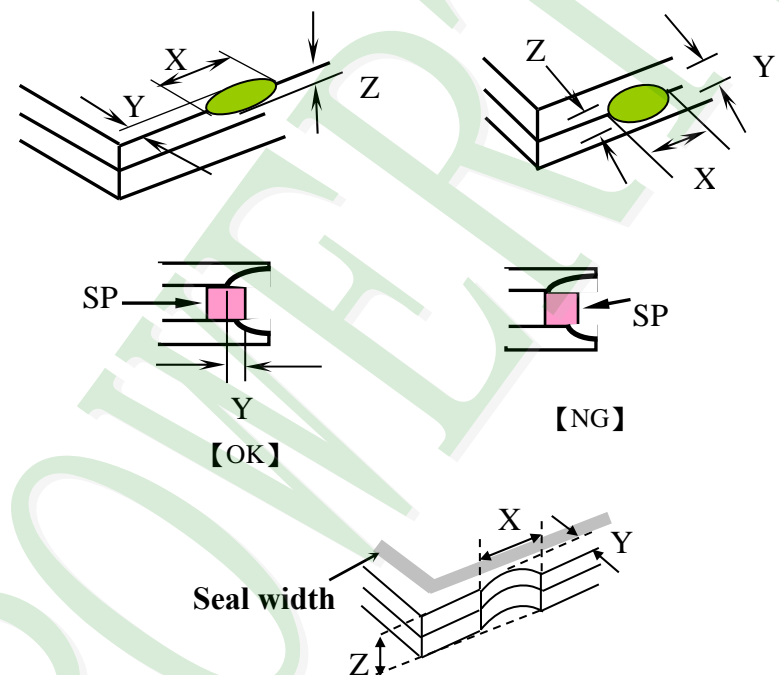
<u>NO</u>	<u>Item</u>	<u>Criterion</u>	<u>Level</u>									
08	The crack of glass	<p>Symbols :</p> <p>X : The length of crack Z : The thickness of crack t : The thickness of glass</p> <p>Y : The width of crack. W : terminal length a : LCD side length</p> <hr/> <p>8.1 General glass chip :</p> <p>8.1.1 Chip on panel surface and crack between panels:</p>  <table border="1" data-bbox="539 1458 1353 1749"> <thead> <tr> <th><u>X</u></th> <th><u>Y</u></th> <th><u>Z</u></th> </tr> </thead> <tbody> <tr> <td>$\leq a$</td> <td>Crack can't enter viewing area</td> <td>$\leq 1/2 t$</td> </tr> <tr> <td>$\leq a$</td> <td>Crack can't exceed the half of SP width.</td> <td>$1/2 t < Z \leq 2 t$</td> </tr> </tbody> </table>	<u>X</u>	<u>Y</u>	<u>Z</u>	$\leq a$	Crack can't enter viewing area	$\leq 1/2 t$	$\leq a$	Crack can't exceed the half of SP width.	$1/2 t < Z \leq 2 t$	Minor
<u>X</u>	<u>Y</u>	<u>Z</u>										
$\leq a$	Crack can't enter viewing area	$\leq 1/2 t$										
$\leq a$	Crack can't exceed the half of SP width.	$1/2 t < Z \leq 2 t$										

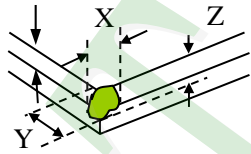
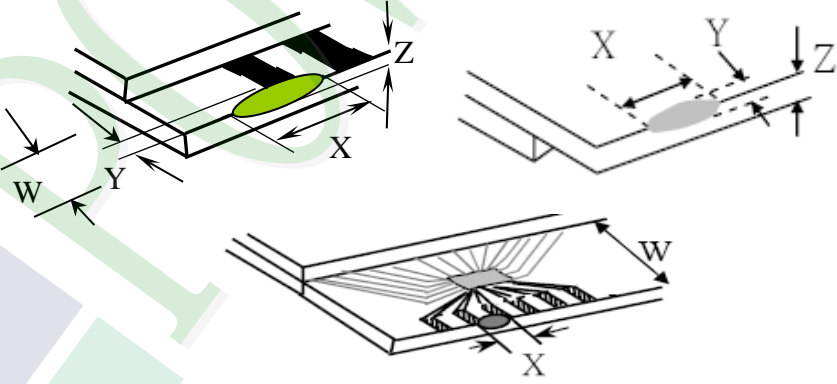
NO	Item	Criterion	Level									
08	The crack of glass	<p>Symbols :</p> <p>X : The length of crack Z : The thickness of crack t : The thickness of glass</p> <p>Y : The width of crack. W : terminal length a : LCD side length</p> <hr/> <p>8.1.2 Corner crack :</p>  <table border="1" data-bbox="525 779 1342 1070"> <thead> <tr> <th>X</th> <th>Y</th> <th>Z</th> </tr> </thead> <tbody> <tr> <td>$\leq 1/5 a$</td> <td>Crack can't enter viewing area</td> <td>$Z \leq 1/2 t$</td> </tr> <tr> <td>$\leq 1/5 a$</td> <td>Crack can't exceed the half of SP width.</td> <td>$1/2 t < Z \leq 2 t$</td> </tr> </tbody> </table>	X	Y	Z	$\leq 1/5 a$	Crack can't enter viewing area	$Z \leq 1/2 t$	$\leq 1/5 a$	Crack can't exceed the half of SP width.	$1/2 t < Z \leq 2 t$	Minor
		X	Y	Z								
$\leq 1/5 a$	Crack can't enter viewing area	$Z \leq 1/2 t$										
$\leq 1/5 a$	Crack can't exceed the half of SP width.	$1/2 t < Z \leq 2 t$										
<p>8.2 Protrusion over terminal :</p> <p>8.2.1 Chip on electrode pad :</p>  <table border="1" data-bbox="563 1675 1351 1850"> <thead> <tr> <th></th> <th>X</th> <th>Y</th> <th>Z</th> </tr> </thead> <tbody> <tr> <td>Front</td> <td>$\leq a$</td> <td>$\leq 1/2 W$</td> <td>$\leq t$</td> </tr> <tr> <td>Back</td> <td>$\leq a$</td> <td>$\leq W$</td> <td>$\leq 1/2 t$</td> </tr> </tbody> </table>		X	Y	Z	Front	$\leq a$	$\leq 1/2 W$	$\leq t$	Back	$\leq a$	$\leq W$	$\leq 1/2 t$
	X	Y	Z									
Front	$\leq a$	$\leq 1/2 W$	$\leq t$									
Back	$\leq a$	$\leq W$	$\leq 1/2 t$									

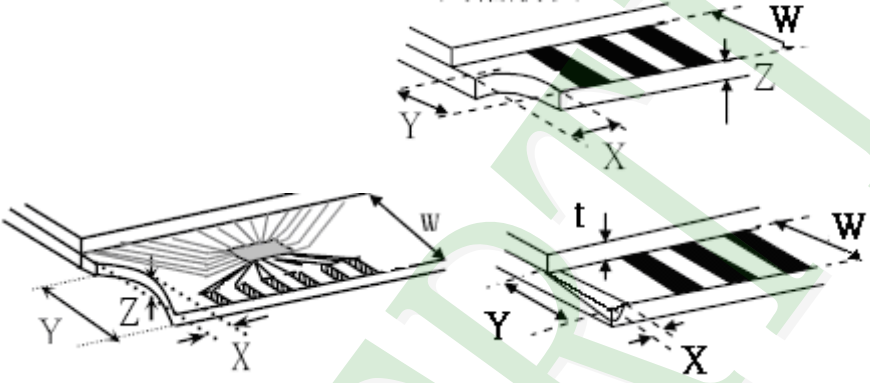
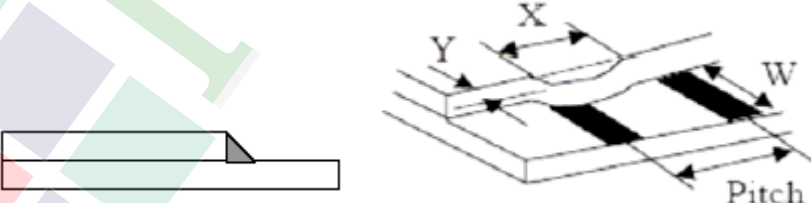
NO	Item	Criterion	Level												
08	The crack of glass	<p>Symbols :</p> <p>X : The length of crack Y : The width of crack. Z : The thickness of crack W : terminal length t : The thickness of glass a : LCD side length</p> <hr/> <p>8.2.2 Non-conductive portion :</p>  <table border="1" data-bbox="619 958 1252 1115"> <thead> <tr> <th><u>X</u></th> <th><u>Y</u></th> <th><u>Z</u></th> </tr> </thead> <tbody> <tr> <td>$\leq 1/3 a$</td> <td>$\leq W$</td> <td>$\leq t$</td> </tr> </tbody> </table> <p>⊙ If the chipped area touches the ITO terminal, over 2/3 of</p> <ul style="list-style-type: none"> the ITO must remain and be inspected according to electrode terminal specifications. <p>8.2.3 Glass remain :</p>  <table border="1" data-bbox="542 1765 1236 1886"> <thead> <tr> <th><u>X</u></th> <th><u>Y</u></th> <th><u>Z</u></th> </tr> </thead> <tbody> <tr> <td>$\leq a$</td> <td>$\leq 1/3 W$</td> <td>$\leq t$</td> </tr> </tbody> </table>	<u>X</u>	<u>Y</u>	<u>Z</u>	$\leq 1/3 a$	$\leq W$	$\leq t$	<u>X</u>	<u>Y</u>	<u>Z</u>	$\leq a$	$\leq 1/3 W$	$\leq t$	Minor
		<u>X</u>	<u>Y</u>	<u>Z</u>											
$\leq 1/3 a$	$\leq W$	$\leq t$													
<u>X</u>	<u>Y</u>	<u>Z</u>													
$\leq a$	$\leq 1/3 W$	$\leq t$													

◆Specification For TFT-LCD Module Less Than 3.5" :
(Ver.B01)

<u>NO</u>	<u>Item</u>	<u>Criterion</u>	<u>Level</u>
09	Backlight elements	9. 1 Backlight can't work normally.	Major
		9. 2 Backlight doesn't light or color is wrong.	Major
		9. 3 Illumination source flickers when lit.	Major
10	General appearance	10. 1 Pin type 、 quantity 、 dimension must match type in structure diagram.	Major
		10. 2 No short circuits in components on PCB or FPC.	Major
		10. 3 Parts on PCB or FPC must be: no wrong parts, missing parts or excess parts.	Major
		10. 4 Product packaging must the same as specified on packaging specification sheet.	Minor
		10. 5 The folding and peeled off in polarizer are not acceptable.	Minor
		10. 6 The PCB or FPC between B/L assembled distance(PCB or FPC) is ≤ 1.5 mm.	Minor

5. PRECAUTION RELATING PRODUCT HANDLING

5.1 SAFETY

- 5.1.1 If the LCD panel breaks, be careful not to get the liquid crystal to touch your skin.
- 5.1.2 If the liquid crystal touches your skin or clothes, please wash it off immediately by using soap and water.

5.2 HANDLING

- 5.2.1 Avoid any strong mechanical shock which can break the glass.
- 5.2.2 Avoid static electricity which can damage the CMOS LSI—When working with the module, be sure to ground your body and any electrical equipment you may be using.
- 5.2.3 Do not remove the panel or frame from the module.
- 5.2.4 The polarizing plate of the display is very fragile. So, please handle it very carefully, do not touch, push or rub the exposed polarizing with anything harder than an HB pencil lead (glass, tweezers, etc.)
- 5.2.5 Do not wipe the polarizing plate with a dry cloth, as it may easily scratch the surface of plate.
- 5.2.6 Do not touch the display area with bare hands, this will stain the display area.
- 5.2.7 Do not use ketonics solvent & aromatic solvent. Use with a soft cloth soaked with a cleaning naphtha solvent.
- 5.2.8 To control temperature and time of soldering is $320 \pm 10^{\circ}\text{C}$ and 3-5 sec.
- 5.2.9 To avoid liquid (include organic solvent) stained on LCM
- 5.2.10 Caution!(LCM products with Capacitive Touch Panel)
Strong EMI-sources such as switch-mode power supplies (SMPS) can lead to touch malfunction (e.g. ghost-touches).
Therefore, the touch needs to be thoroughly tested inside the target application.
- 5.2.11 CAUTION: Continuously displaying same static image will result in high possibility of image sticking/image burn-in effect due to TFT panel characteristic.
- 5.2.12 Double-sided tape designed to be attach with the customer's mechanical device, please follow up the rules and regulations published by the original manufacturer of double-sided tape for the attachment operation.

5.3 STORAGE

- 5.3.1 Store the panel or module in a dark place where the temperature is $25^{\circ}\text{C} \pm 5^{\circ}\text{C}$ and the humidity is below 65% RH.
- 5.3.2 Do not place the module near organics solvents or corrosive gases.
- 5.3.3 Do not crush, shake, or jolt the module.

5.4 TERMS OF WARRANTY

- 5.4.1 Applicable warrant period The period is within thirteen months since the date of shipping out under normal using and storage conditions.
- 5.4.2 Unaccepted responsibility
This product has been manufactured to your company's specification as a part for use in your company's general electronic products. It is guaranteed to perform according to delivery specifications. For any other use apart from general electronic equipment, we cannot take responsibility if the product is used in nuclear power control equipment, aerospace equipment, fire and security systems or any other applications in which there is a direct risk to human life and where extremely high levels of reliability are required.

A B C D E F G H

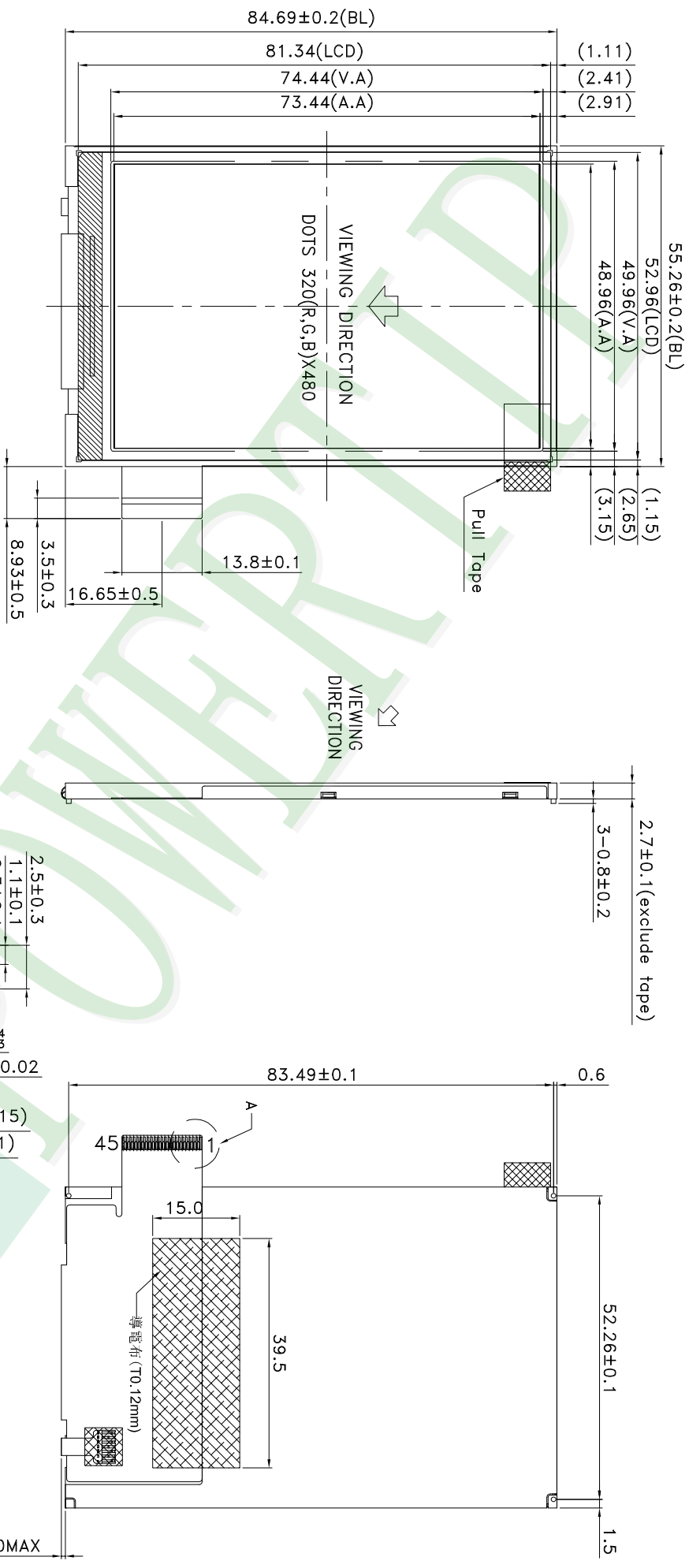

NOTES:

1. LCD TYPE: a-SI TFT
2. LCD DISPLAY: POSITIVE/TRANSMISSIVE
3. VIEW DIRECTION: 12 O'CLOCK
4. The tolerance unless classified $\pm 0.3 \text{ mm}$, R for not assigned 0.5 mm
5. FPC suggested connector: "Hirose" FH26-45S-0.3SHW or compatible

007					
006					
005					
004					
003					
002					
001	NEW DRAWING	Eva	2015/07/08		
REV	REV BY	REVISER	DATE		

PART NO:		PH320480T009-LAA01	
DRAWING NAME:		LMD-PH320480T009-LAA01	
TITLE:		LCD MODULE DRAWING	
Design	Eva Liao	Unit	MM
Check	Tina Chen	Scale	FIT
Approve	Linda Lee	Page	1/1
久正光電股份有限公司		Surface	Material
POWER TIP TECHNOLOGY CORPORATION		Thickness	Quantity
		Tolerance (mm)	Precision Level
		1 ~ 4	-
		4 ~ 16	-
		16 ~ 63	-
		63 ~ 250	-
		250 ~ 1000	-

Ver.002

LCM包裝規格書

Documents NO. JPKG-PH320480T009-LAA01

LCM Packaging Specifications
(For Tray)

Approve	Check	Contact
Terry	--	Air

1. 包裝材料規格表 (Packaging Material) : (per carton)

No.	Item	Model	Dimensions (mm)	1Pcs Weight	Quantity	Total Weight
1	成品 (LCM)	PH320480T009-LAA01	55.26 X 84.69 X 2.7	0.0203	288	5.8464
2	多層薄膜(1)POF	OTFILM0BA03ABA	19"X350X0.015	—	6	—
3	TRAY 盤 (2)Tray	TYSG000000412	352 X 260 X 12.8	0.1	42	4.2
4	內盒(3)Product Box	BX36627063ABBA	383 X 270 X 66	0.182	6	1.092
5	保利龍板(4)Pollyon board	OTPLB00PL08ABA	550 X 393 X 20	0.0284	2	0.0568
6	外紙箱(5)Carton	BX57041027CCBA	570 X 410 X 265	1.0	1	1.0
7						
8						
9						

2. 一整箱總重量 (Total LCD Weight in carton) : 12.20 Kg±10%

3. 單箱數量規格表 (Packaging Specifications and Quantity) :

(1) LCM quantity per box : no per tray	8	x no of tray	6	=	48
(2) Total LCM quantity in carton : quantity per box	48	x no of boxes	6	=	288

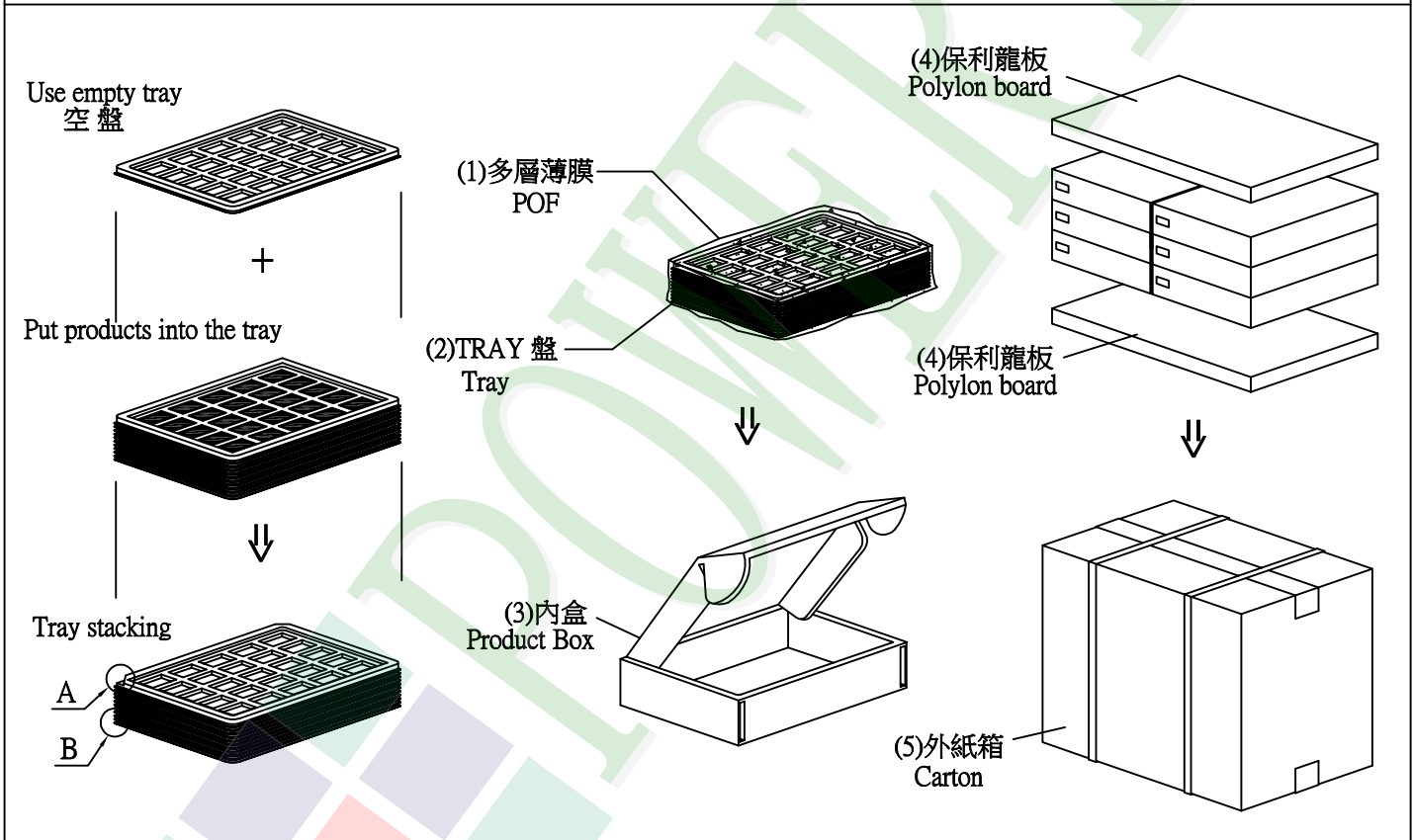

特 記 事 項 (REMARK)

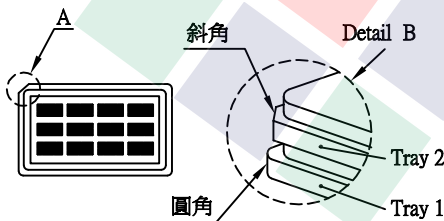

4. TRAY 盤相疊時, 需旋轉180度, 請詳見B視圖
Rotate tray 180 degrees and place on top of stack.
Check the tray stack using Fig. B.