

Serie Medium

300 Nylon Cable Chain

Inner height (D) 17 mm
Single link construction with anti-friction single-pin. Non-opening. The chain is an extremely strong 18 mm chain, particularly suitable for high frequency/acceleration operations, like on laser cutting heads, in which the chain is highly stressed, due to high acceleration in all 3 directions.

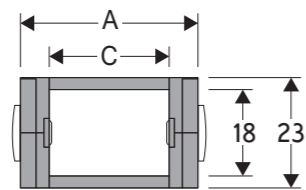

Pin
Part.no PG300

Technical characteristics when self-supported

Speed	10 m/s
Acceleration	50 m/s ²

For higher requirements please consult our technical dept.

A	B	C	D	R	Weight/m	Chain
mm	mm	mm	mm	mm	kg	Part Number
30	23	14	18	040-060-080-120	0,38	300015 □□□ *
41	23	25	18	040-060-080-120	0,43	300025 □□□ *
52	23	36	18	040-060-080-120	0,48	300035 □□□ *

*Complete the code by inserting the value of the radius (R): Ex. 300015 □□□ □

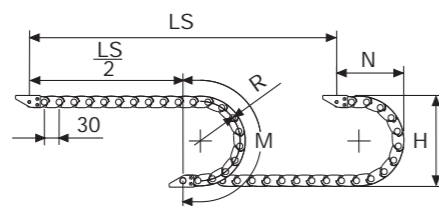

R	H	N	M	N1	M1
mm	mm	mm	mm	mm	mm
40	103	85	185	185	385
60	143	105	248	410	865
80	183	125	315	545	1165
120	263	165	440	750	1640

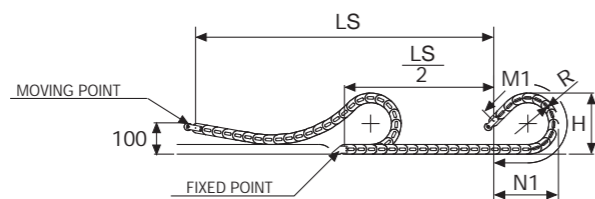

For sliding applications, technical data can slightly change according to frequency, added weight and environment.

Length of chain (L)
Half travel distance ($\frac{LS}{2}$)
plus length of curve (M) or (M1)

$$L = \frac{LS}{2} + M \text{ or } M1$$

Self-Supporting Capacity Diagram

The maximum length of the self-supporting capacity ($\frac{LS}{2}$) in relationship to the weight of the cables and hoses contained per linear metre.

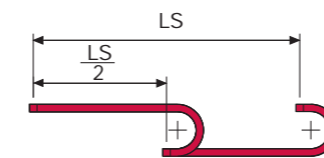
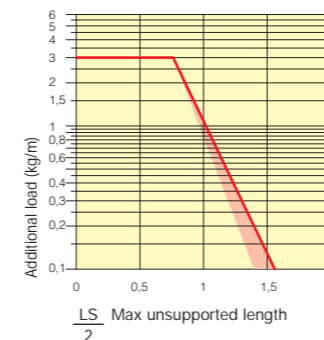

The red marking in the diagram area considers the difference of weight between various widths of chain.

For applications with $\frac{LS}{2}$ and weights not included in the area of the diagram showing self-supporting capacity, verify the possible use of support rollers (see page 30).

Bright Zinc Plated Steel End Brackets***

The end brackets set allows the two ends of the chain to be attached to the equipment.

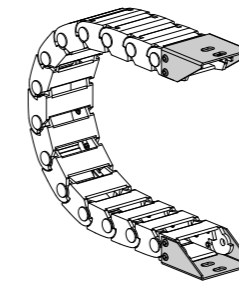
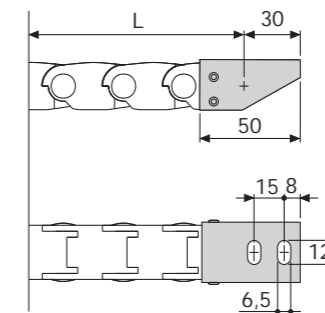

Fig. A
Chain fixed outside the radius. (Fig A)
See end brackets mounting variations page 31.



Bright Zinc Plated Steel Type Part Numbers

Complete Set Assembled	End Brackets
Chain	Set
300015...	AP300KM □**
300025...	AG300KM □**
300035...	A300035KM □**

Complete Set Unassembled	End Brackets
Chain	Set
300015...	AP300K □**
300025...	AG300K □**
300035...	A300035K □**

** 1=Pos.1; 2=Pos.2; 3=Pos.3
*** Available on request in stainless steel

Serie Medium

300 Nylon Cable Chain

3



Suitable to long travel distance.
To choose the guide channel see page 54

Special tool to remove the connecting pivots:
Part Number PZ010.



For further information please consult Brevetti Stendalto's Technical Office

