



ProLight PBVE-17FWU-F5G
17W Power LED
Technical Datasheet
Version: 1.0

ProLight Opto © ProEngine Series

Features

- High flux density of lighting source
- Good color uniformity
- RoHS compliant
- More energy efficient than incandescent and most halogen lamps
- Long lifetime
- AEC-Q101 Qualified
- SAE/ECE compliant

Main Applications

- Bicycle Lamps
- Exterior Automotive Lighting
- Floodlight

Automotive

Introduction

- The input power is 17 Watt, the multi-chip ultra high power ProEngine Series delivers never before seen luminous flux output from a single emitter. The superficial illuminating nature of ProEngine makes them the preference bicycle lamps, typical applications include exterior automotive lighting and floodlight.

Mechanical Dimensions

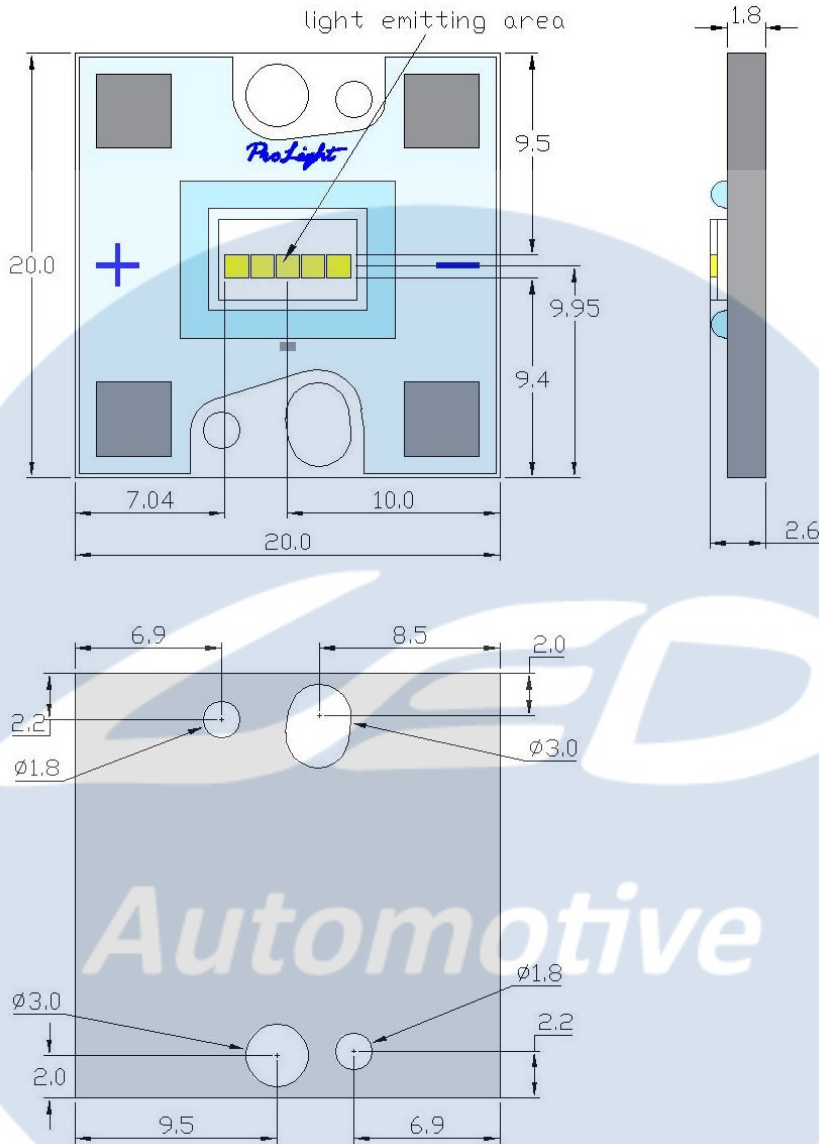

Notes:

1. Solder pads are labeled "+" and "-" to denote positive and negative, respectively.
2. Drawing not to scale.
3. All dimensions are in millimeters.
4. Unless otherwise indicated, tolerances are $\pm 0.30\text{mm}$.
5. **Please do not use a force of over 0.3kgf impact or pressure on the lens of the LED, otherwise it will cause a catastrophic failure.**

*The appearance and specifications of the product may be modified for improvement without notice.

Flux Characteristics, $T_j = 25^\circ\text{C}$

Radiation Pattern	Color	Part Number Emitter	Luminous Flux Φ_v (lm)			
			@1000mA		Refer @1200mA	
			Minimum	Typical	Minimum	Typical
Lambertian	White	PBVE-17FWU-F5G	1400	1650	1600	1900

- ProLight maintains a tolerance of $\pm 7\%$ on flux and power measurements.
- Please do not drive at rated current more than 1 second without proper heat sink.

Electrical Characteristics, $T_j = 25^\circ\text{C}$

Color	Forward Voltage V_F (V) @1000mA			Forward Voltage V_F (V) Refer @1200mA	Thermal Resistance Junction to Board ($^\circ\text{C/W}$)
	Min.	Typ.	Max.	Typ.	
White	12.0	16.2	19.2	16.5	2.2

- ProLight maintains a tolerance of $\pm 0.1\text{V}$ for Voltage measurements.

Optical Characteristics at 1000mA, $T_j = 25^\circ\text{C}$

Radiation Pattern	Color	Color Temperature CCT			Total included Angle (degrees) $\theta_{0.90V}$	Viewing Angle (degrees) $2\theta_{1/2}$
		Min.	Typ.	Max.		
Lambertian	White	5380 K	5610 K	5850 K	160	120
		5610 K	5850 K	6100 K	160	120
		5850 K	6100 K	6370 K	160	120
		6100 K	6370 K	6680 K	160	120

- ProLight maintains a tolerance of $\pm 5\%$ for CCT measurements.

Absolute Maximum Ratings

Parameter	White
Max DC Forward Current (mA)	1500
Peak Pulsed Forward Current (mA)	1500 (less than 1/10 duty cycle@1KHz)
LED Junction Temperature	150°C
Junction Temperature for short time applications*	175°C
Operating Board Temperature at Maximum DC Forward Current	-40°C - 75°C
Storage Temperature	-40°C - 100°C
Reverse Voltage	Not designed to be driven in reverse bias
ESD withstand voltage(kV) (acc. to IEC 61000-4-2-air discharge)	up to 8

Note: * The LED chip exhibits excellent performance but slight package discoloration occurs at highest temperatures. Exemplary median lifetime for $T_j = 175^\circ\text{C}$ is 100h.



Color Bin

White Binning Structure Graphical Representation

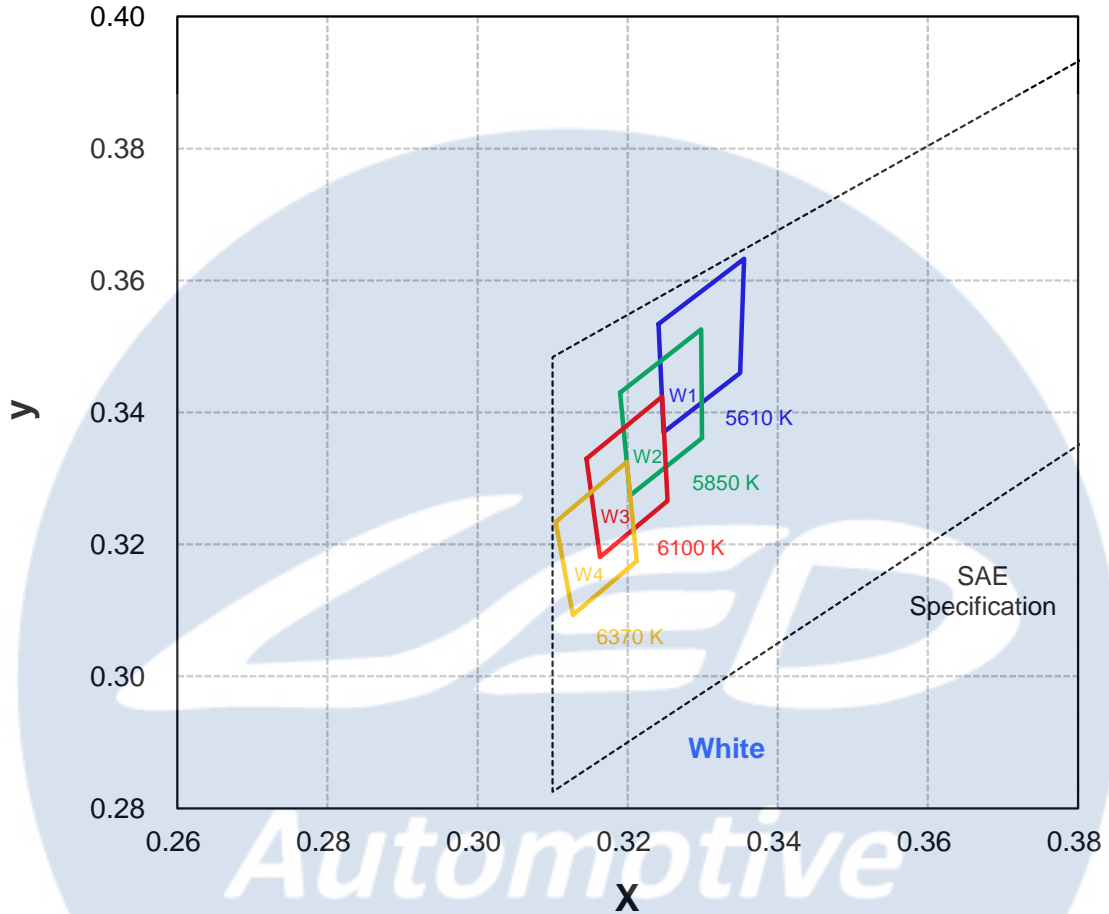

White Bin Structure

Bin Code	x	y	Typ. CCT (K)	Bin Code	x	y	Typ. CCT (K)
W1	0.3241	0.3534	5610	W3	0.3145	0.3330	6100
	0.3248	0.3370			0.3163	0.3181	
	0.3350	0.3460			0.3253	0.3266	
	0.3355	0.3633			0.3246	0.3424	
W2	0.3190	0.3430	5850	W4	0.3104	0.3234	6370
	0.3203	0.3274			0.3127	0.3093	
	0.3299	0.3361			0.3212	0.3175	
	0.3298	0.3526			0.3199	0.3325	

- Tolerance on each color bin (x, y) is ± 0.005

Color Spectrum, $T_c = 25^\circ\text{C}$

1. White

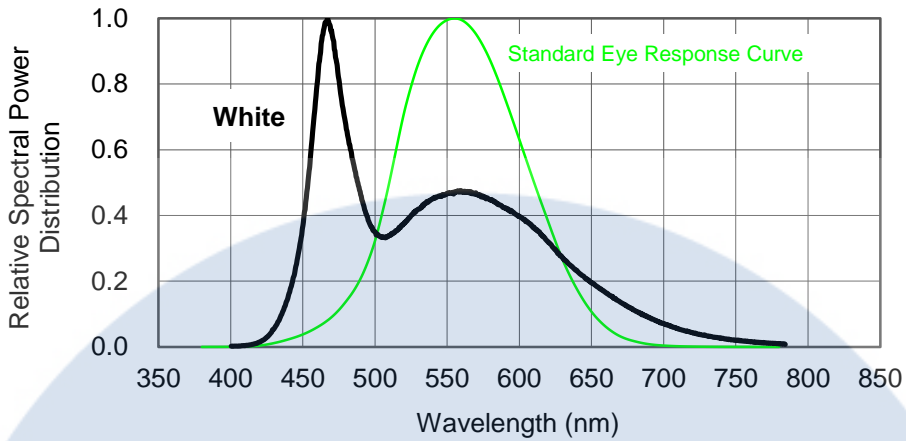

LED
Automotive

Junction Temperature Relative Characteristics

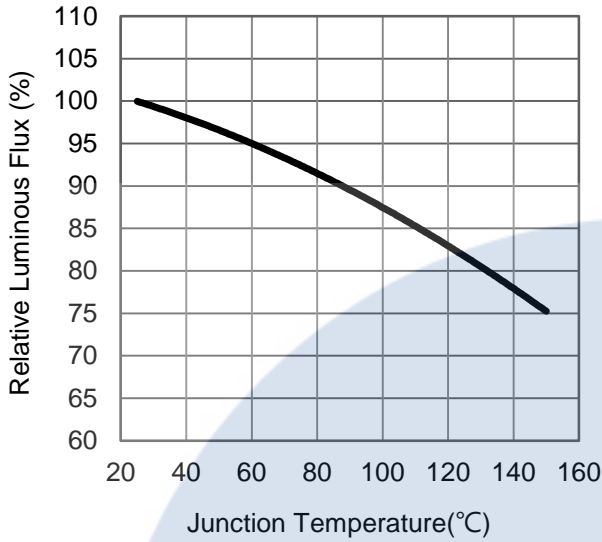

Fig 1. Junction Temperature vs. Relative Luminous Flux at 1000mA.

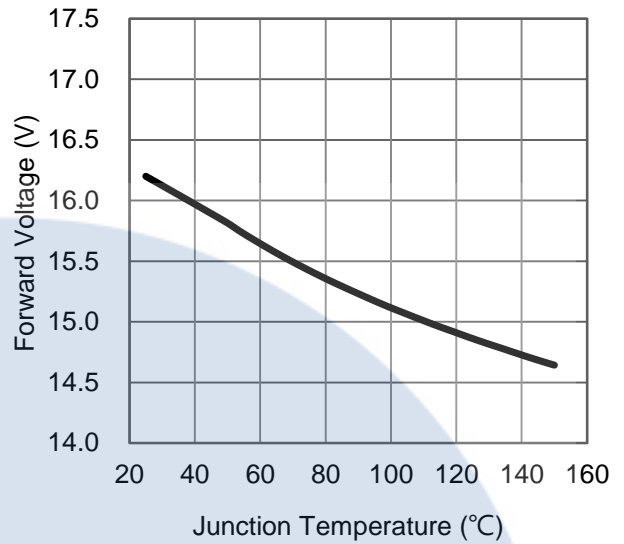

Fig 2. Junction Temperature vs. Forward Voltage at 1000mA.

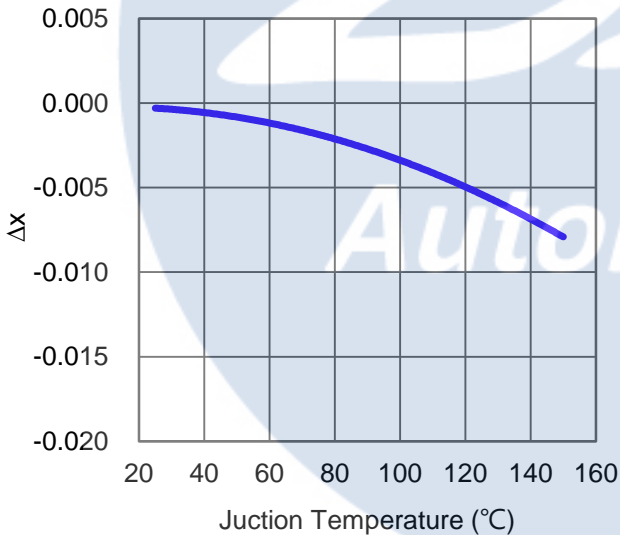

Fig 3. Junction Temperature vs. Chromaticity Coordinate Δx at 1000mA.

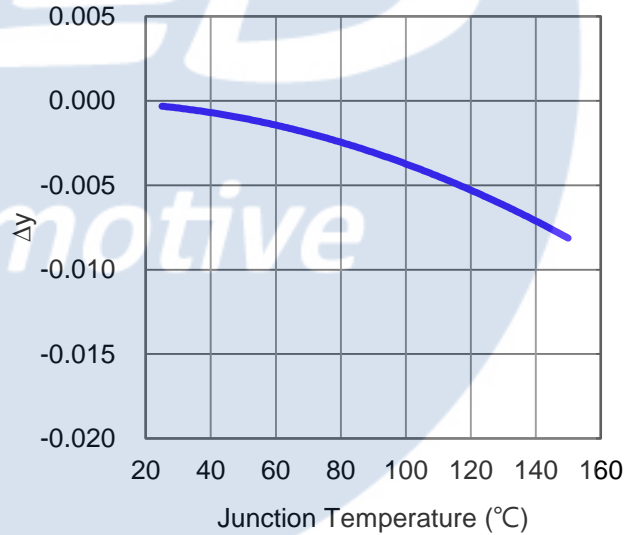

Fig 4. Junction Temperature vs. Chromaticity Coordinate Δy at 1000mA.

Forward Current Relative Characteristics

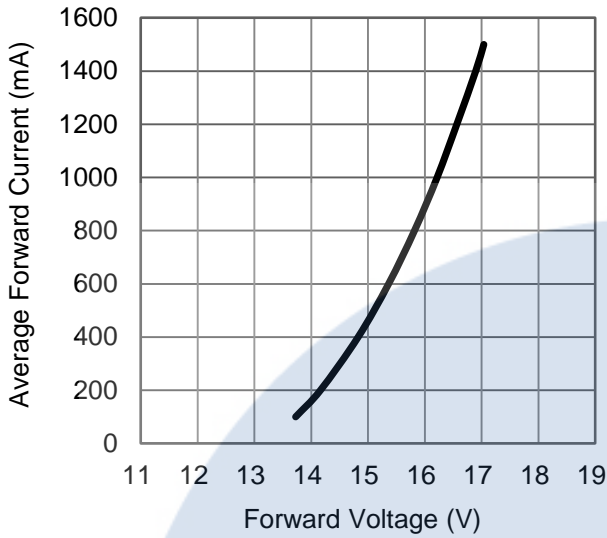

Fig 5. Forward Voltage vs. Forward Current at $T_j=25^\circ\text{C}$.

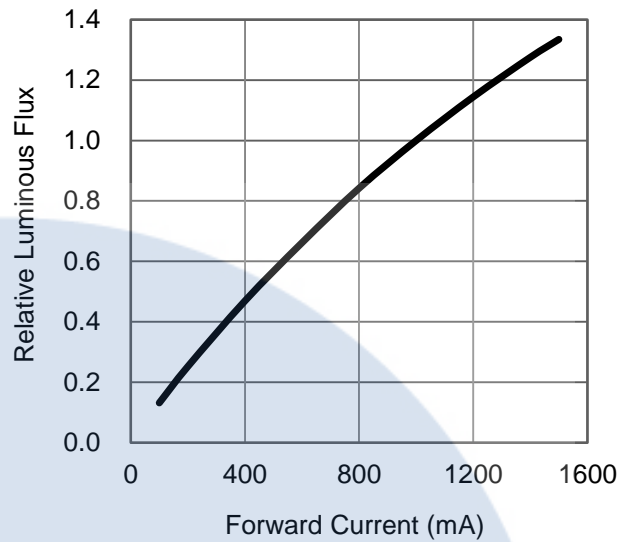

Fig 6. Forward Current vs. Relative Luminous Flux at $T_j=25^\circ\text{C}$.

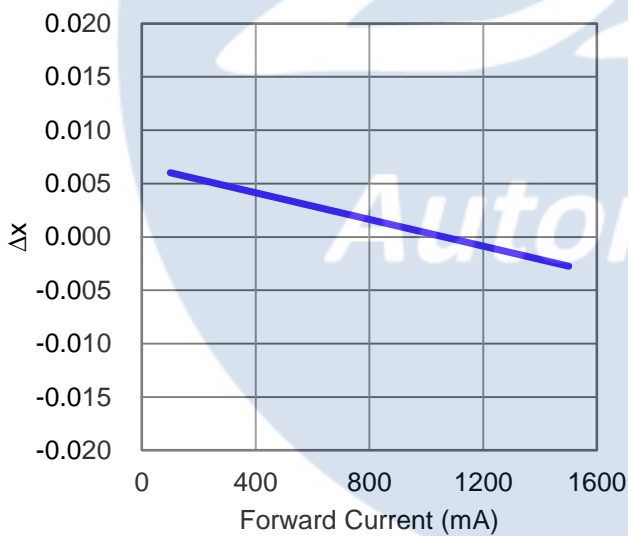

Fig 7. Forward Current vs. Chromaticity Coordinate Δx at $T_j=25^\circ\text{C}$.

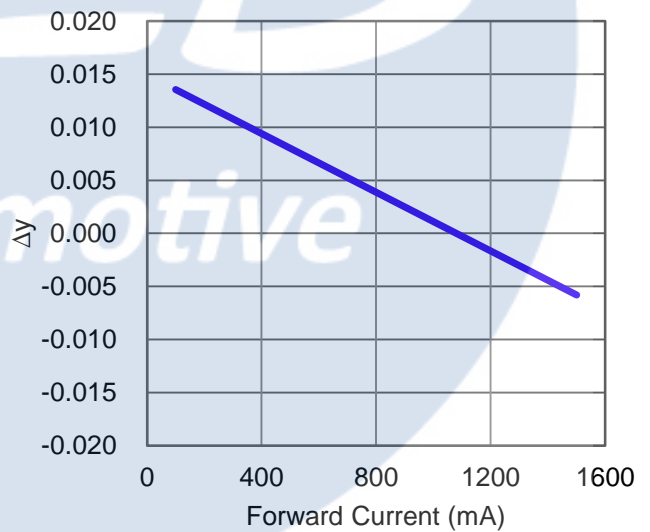
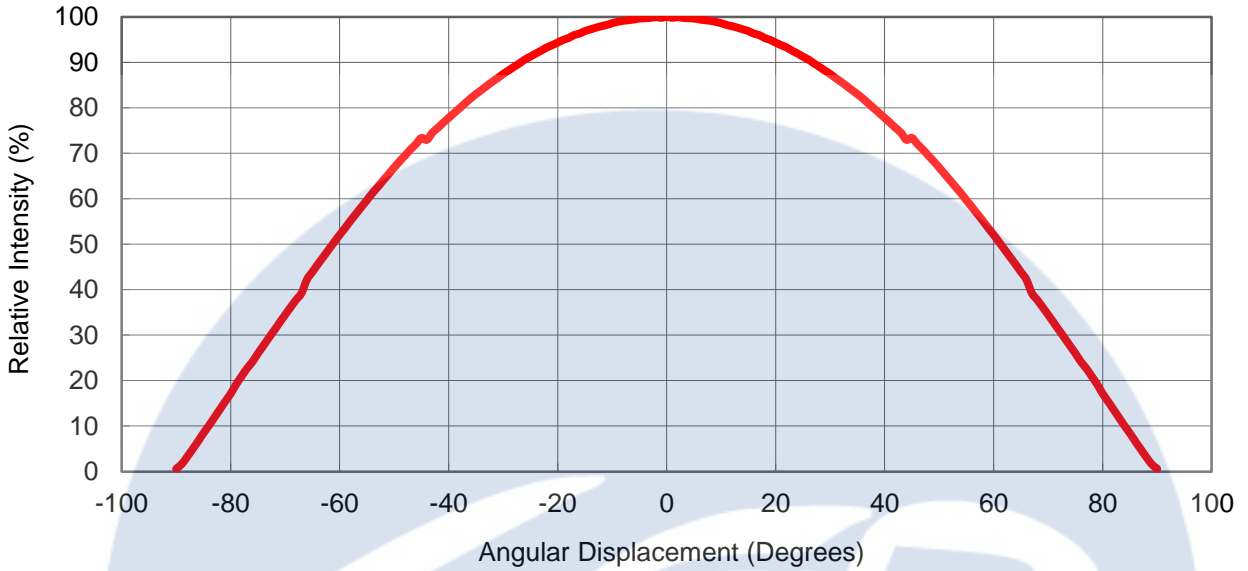

Fig 8. Forward Current vs. Chromaticity Coordinate Δy at $T_j=25^\circ\text{C}$.

Typical Representative Spatial Radiation Pattern

Lambertian Radiation Pattern



Polar Radiation Pattern

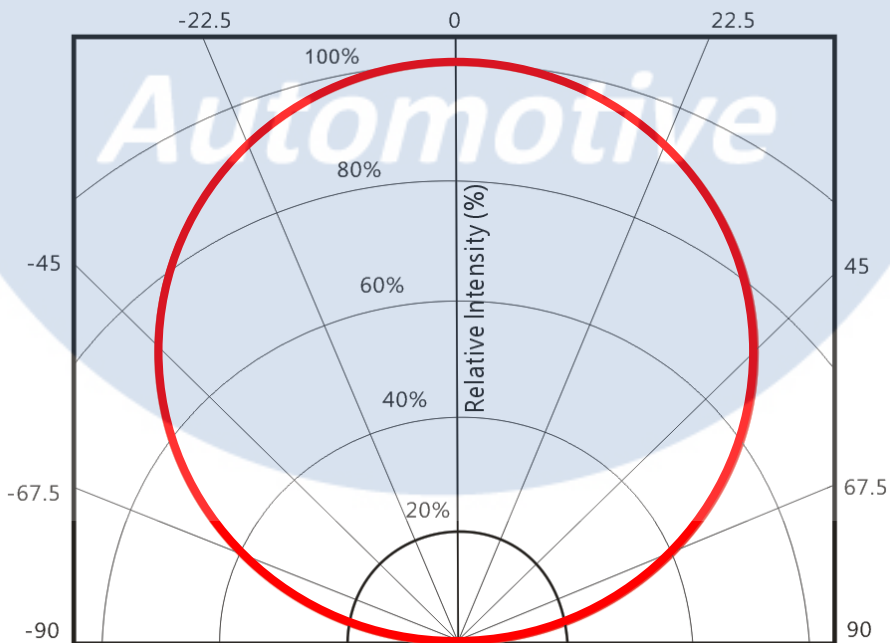

Moisture Sensitivity Level – JEDEC Level 1

Level	Floor Life		Soak Requirements			
			Standard		Accelerated Environment	
	Time	Conditions	Time (hours)	Conditions	Time (hours)	Conditions
1	Unlimited	≤30°C / 85% RH	168 +5/-0	85°C / 85% RH	NA	NA

- The standard soak time includes a default value of 24 hours for semiconductor manufacture's exposure time (MET) between bake and bag and includes the maximum time allowed out of the bag at the distributor's facility.
- Table below presents the moisture sensitivity level definitions per IPC/JEDEC's J-STD-020C.

Level	Floor Life		Soak Requirements			
			Standard		Accelerated Environment	
	Time	Conditions	Time (hours)	Conditions	Time (hours)	Conditions
1	Unlimited	≤30°C / 85% RH	168 +5/-0	85°C / 85% RH	NA	NA
2	1 year	≤30°C / 60% RH	168 +5/-0	85°C / 60% RH	NA	NA
2a	4 weeks	≤30°C / 60% RH	696 +5/-0	30°C / 60% RH	120 +1/-0	60°C / 60% RH
3	168 hours	≤30°C / 60% RH	192 +5/-0	30°C / 60% RH	40 +1/-0	60°C / 60% RH
4	72 hours	≤30°C / 60% RH	96 +2/-0	30°C / 60% RH	20 +0.5/-0	60°C / 60% RH
5	48 hours	≤30°C / 60% RH	72 +2/-0	30°C / 60% RH	15 +0.5/-0	60°C / 60% RH
5a	24 hours	≤30°C / 60% RH	48 +2/-0	30°C / 60% RH	10 +0.5/-0	60°C / 60% RH
6	Time on Label (TOL)	≤30°C / 60% RH	Time on Label (TOL)	30°C / 60% RH	NA	NA

Reliability testing in accordance with AEC-Q101 (Rev D1)

The development of this product included extensive operational life-time testing and environmental testing. Table 1 summarizes the tests applied and cumulative test results obtained from testing performed in accordance with AEC-Q101(Rev D1).

Table 1. Operating life, mechanical and environmental tests performed on it's package in accordance with AEC-Q101 (Rev D1).

Abrr Stress	Conditions	Duration	Failure Criteria	Rejects
TEST Pre- and Post-Stress Electrical Test	$T_J = 25^{\circ}\text{C}$	N/A	See notes [2]	0
PC Pre-conditioning	JESD22-A113 Soak $T_{amb} = 85^{\circ}\text{C}$, RH = 85% Reflow soldering	168 hours 3 cycles	See notes [2]	0
EV External Visual	JESD22 B-101	N/A	See notes [2]	0
HTFB High Temperature Forward Bias	JESD22-A108 $T_{amb} = 85^{\circ}\text{C}$, IF = max. DC [1]	1000 hours	See notes [2]	0
TC Temperature Cycling	JESD22-A104 -30°C to 80°C	1000 cycles	See notes [2]	0
HTHHB High temp. & High Humidity Bias	JESD22-A101 $T_{amb} = 85^{\circ}\text{C}$, RH = 85%, IF = max. DC [1]	1000 hours	See notes [2]	0
PTC Power and Temperature cycle	-30°C to 85°C , 10 minutes dwell, 20 minutes transfer (1 hour cycle), 2 minutes ON/2 minutes OFF, IF = max. DC [1]	1000 hours	See notes [2]	0
ESD	AEC Q101-001	8000V	See notes [2]	0
VVF Vibration Variable Frequency	10-2000-10 Hz, log or linear sweep rate, 20 G about 1 min., 1.5 mm, 3X/axis	--	See notes [3]	0
MS Mechanical Shock	1500 G, 0.5 msec. pulse, 5 shocks each 6 axis	--	See notes [3]	0
RSH Resistance to Solder Heat	JESD22-A111 / JESD22-B106 $260^{\circ}\text{C} \pm 5^{\circ}\text{C}$	10 s	See notes [3]	0
SD Solderability	J-STD-002 $245^{\circ}\text{C} \pm 5^{\circ}\text{C}$	3 s	See notes [3]	0

Notes:

1. Depending on the maximum derating curve.
2. Criteria for judging failure

Item	Test Condition	Criteria for Judgement	
		Min.	Max.
Forward Voltage (V_F)	$I_F = \text{max DC}$	--	Initial Level x 1.1
Luminous Flux or Radiometric Power (Φ_V)	$I_F = \text{max DC}$	Initial Level x 0.8	--
Reverse Current (I_R)	$V_R = 5\text{V}$	--	50 μA

* The test is performed after the LED is cooled down to the room temperature.

3. A failure is an LED that is open or shorted.



Packing Specifications

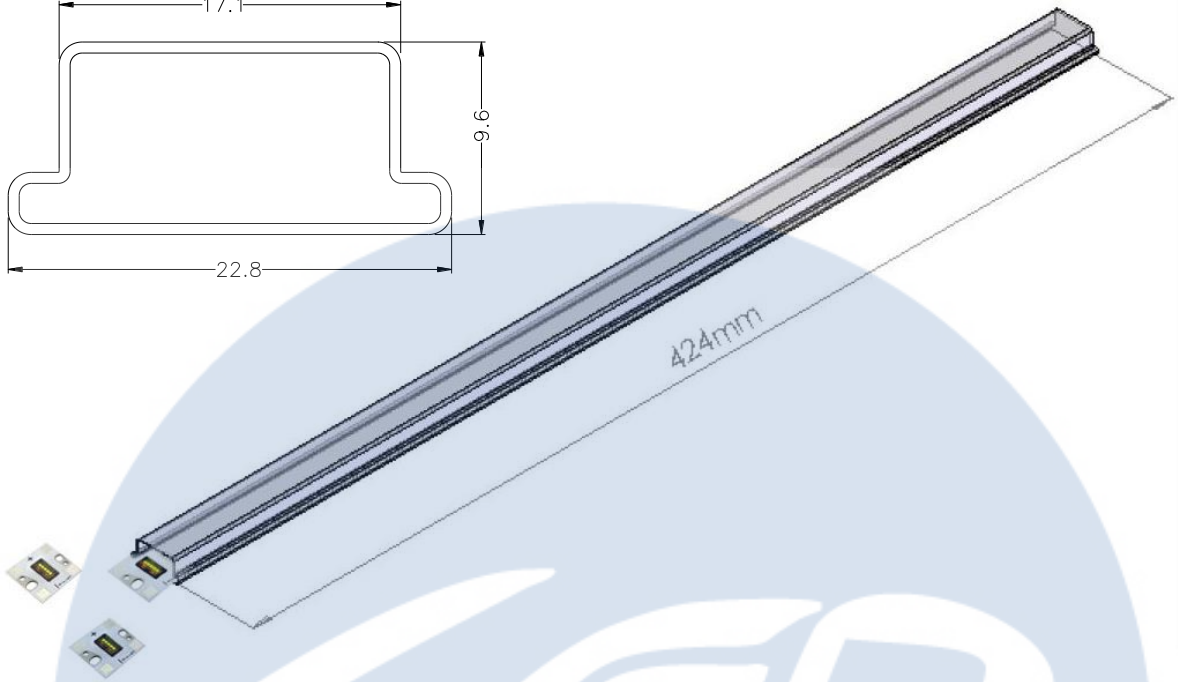
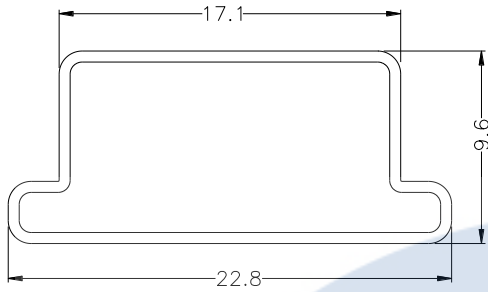

LED

Automotive

Notes:

1. 20 pieces per tube.
2. Drawing not to scale.
3. All dimensions are millimeters.
4. All dimensions without tolerances are for reference only.

** Please do not open the moisture barrier bag (MBB) more than one week. This may cause the leads of LED discoloration. We recommend storing ProLight's LEDs in a dry box after opening the MBB. The recommended storage conditions are temperature 5 to 30°C and humidity less than 40% RH.

Recommended Soldering Condition

- Please use lead free and “no clean ” solders.
- Soldering shall be implemented using a soldering tip at a temperature lower than 350 °C, and shall be finished within 3.5 seconds for each pad.
- During the soldering process, put the LEDs on materials whose conductivity is poor enough not to radiate heat of soldering.
- Properly solder tin wires before soldering them to LEDs.
- Avoid touching the glass lens with the soldering iron.
- Please prevent flux from touching to the glass lens.
- Please solder evenly on each pad.
- Contacts number of a soldering tip should be within twice for each pad.
- Next process of soldering should be carried out after the LEDs have return to ambient temperature.

*ProLight cannot guarantee if usage exceeds these recommended conditions.

Please use it after sufficient verification is carried out on your own risk if absolutely necessary.

Precaution for Use

- The modules light output are intense enough to cause injury to human eyes if viewed directly. Precautions must be taken to avoid looking directly at the modules with unprotected eyes.
- The modules are sensitive to electrostatic discharge. Appropriate ESD protection measures must be taken when working with the modules. Non-compliance with ESD protection measures may lead to damage or destruction of the product.
- Chemical solvents or cleaning agents must not be used to clean the modules. Mechanical stress on the Emitters must be avoided. It is best to use a soft brush, damp cloth or low-pressure compressed air.
- The products should be stored away from direct light in dry location.
- The appearance, specifications and flux bin of the product may be modified for improvement without notice. Please refer to the below website for the latest datasheets.
<http://www.prolightopto.com/>

Handling of without Cover Lens LEDs

Notes for handling of without cover lens LEDs

- Please do not use a force of over 0.3kgf impact or pressure on the emitting area, otherwise it will cause a catastrophic failure.
- Avoid touching the emitting area especially by sharp tools such as Tweezers.
- Avoid leaving fingerprints on the emitting area .
- Please store the LEDs away from dusty areas or seal the product against dust.
- Please do not mold over the emitting area with another resin. (epoxy, urethane, etc)

