



ProLight PBED-15F4E-A
15W Power LED
Technical Datasheet
Version: 1.2

ProLight Opto ® ProEngine Series

Features

- Compact light source
- R, G, B, A four color in one package
- Maximum drive current: 1000mA per LED die
- Lead free reflow soldering
- Superior ESD protection
- RoHS compliant

Main Applications

- Entertainment lighting (Stage lighting)
- Architectural lighting
- Mood lighting
- Outdoor lighting
- Indoor lighting

Introduction

- ProLight PBED colorful series is a color changeable LED with maximum 4 color chips in one package. Compared to discrete LEDs, PBED series reduce the distance between LED die, creating a small optical source for excellent optical control and efficient color mixing. ProLight PBED series is much suitable for the application of color-changing lighting, especially for entertainment lighting.

Emitter Mechanical Dimensions

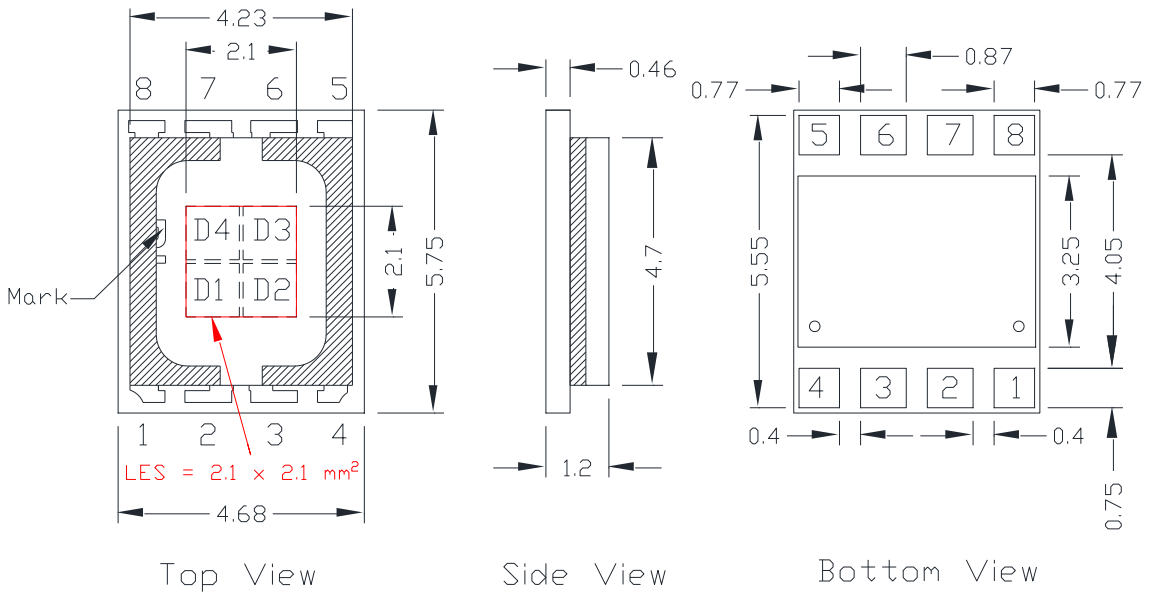

Circuit Diagram

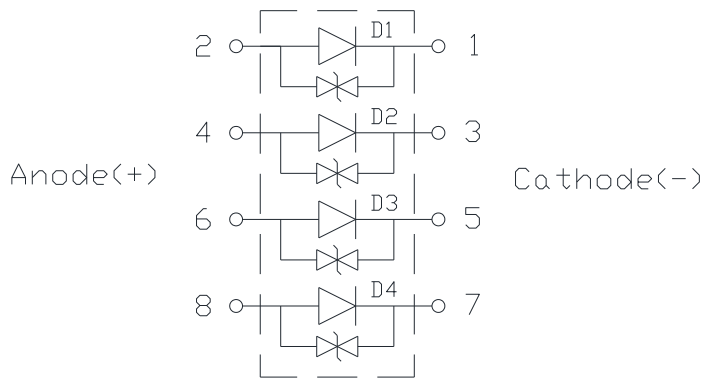

Color

D1 : Red
D2 : Green
D3 : Blue
D4 : Amber

Notes:

1. Drawing not to scale.
2. All dimensions are in millimeters.
3. Unless otherwise indicated, tolerances are $\pm 0.15\text{mm}$.
4. Please do not solder the emitter by manual hand soldering, otherwise it will damage the emitter.
5. **Please do not use a force of over 1kgf impact or pressure on the lens of the LED, otherwise it will cause a catastrophic failure.**

*The appearance and specifications of the product may be modified for improvement without notice.

Flux Characteristics, $T_j = 25^\circ\text{C}$

Color	Part Number Emitter	Luminous Flux or Radiometric Power			
		@700mA		Refer @1000mA	
		Minimum	Typical	Minimum	Typical
Red	PBED-15F4E-A	59 lm	70 lm	78 lm	94 lm
Green		140 lm	170 lm	169 lm	212 lm
Blue		760 mW	860 mW	975 mW	1135 mW
Amber		56 lm	70 lm	70 lm	89 lm

- ProLight maintains a tolerance of $\pm 7\%$ on flux and power measurements.
- Please do not drive at rated current more than 1 second without proper heat sink.

Electrical Characteristics, $T_j = 25^\circ\text{C}$

Color	Forward Voltage V_F (V) @700mA			Forward Voltage V_F (V) Refer @1000mA	Thermal Resistance Junction to Slug ($^\circ\text{C}/\text{W}$)
	Min.	Typ.	Max.	Typ.	
	Red	2.10	2.40	2.90	
Green	2.90	3.50	4.20	3.75	
Blue	2.90	3.30	4.00	3.45	
Amber	2.10	2.50	3.00	2.65	

- ProLight maintains a tolerance of $\pm 0.1\text{V}$ for Voltage measurements.

Optical Characteristics at 700mA, $T_j = 25^\circ\text{C}$

Radiation Pattern	Color	Dominant Wavelength λ_D , or Color Temperature CCT			Total included Angle (degrees)	Viewing Angle (degrees)
		Min.	Typ.	Max.	$\theta_{0.90V}$	$2\theta_{1/2}$
		Lambertian	Red	620 nm	623 nm	630 nm
Green	525 nm		529 nm	533 nm	160	120
Blue	453 nm		455 nm	457 nm	160	120
Amber	589 nm		593 nm	596 nm	160	120

- ProLight maintains a tolerance of $\pm 1\text{nm}$ for dominant wavelength measurements.
- ProLight maintains a tolerance of $\pm 5\%$ for CCT measurements.

Absolute Maximum Ratings

Parameter	Red/Green/Blue/Amber
DC Forward Current (mA)	1000
Peak Pulsed Forward Current (mA)	1500 (less than 1/10 duty cycle@1KHz)
ESD Sensitivity (HBM per MIL-STD-883E Method 3015.7)	±4000V (Class III)
LED Junction Temperature	135°C
Operating Board Temperature at Maximum DC Forward Current	-40°C - 85°C
Storage Temperature	-40°C - 120°C
Soldering Temperature	JEDEC 020c 260°C
Allowable Reflow Cycles	3
Reverse Voltage	Not designed to be driven in reverse bias

Photometric Luminous Flux Bin Structure at 700mA

Color	Bin Code	Minimum Photometric Flux (lm)	Maximum Photometric Flux (lm)
Red	A	59	71
	B	71	86
Green	A	140	165
	B	165	200
Amber	A	56	71
	B	71	90

- ProLight maintains a tolerance of $\pm 7\%$ on flux and power measurements.
- The flux bin of the product may be modified for improvement without notice.

Radiometric Power Bin Structure at 700mA

Color	Bin Code	Minimum Radiometric Power (mW)	Maximum Radiometric Power (mW)
Blue	A	760	860
	B	860	1000

- ProLight maintains a tolerance of $\pm 7\%$ on flux and power measurements.
- The flux bin of the product may be modified for improvement without notice.

Dominant Wavelength Bin Structure

Color	Bin Code	Minimum Dominant Wavelength (nm)	Maximum Dominant Wavelength (nm)
Red	4	620	630
Green	2	525	533
Blue	6	453	457
Amber	4	589	596

- ProLight maintains a tolerance of ± 1 nm for dominant wavelength measurements.

Note: Although several bins are outlined, product availability in a particular bin varies by production run and by product performance. Not all bins are available in all colors.

Forward Voltage Bin Structure

Color	Bin Code	Minimum Voltage (V)	Maximum Voltage (V)
Red	0	2.1	2.9
Green	0	2.9	4.2
Blue	0	2.9	4.0
Amber	0	2.1	3.0

- ProLight maintains a tolerance of ± 0.1 V for Voltage measurements.

Note: Although several bins are outlined, product availability in a particular bin varies by production run and by product performance. Not all bins are available in all colors.

Color Spectrum, $T_j = 25^\circ\text{C}$

1. Blue \ Green \ Amber \ Red

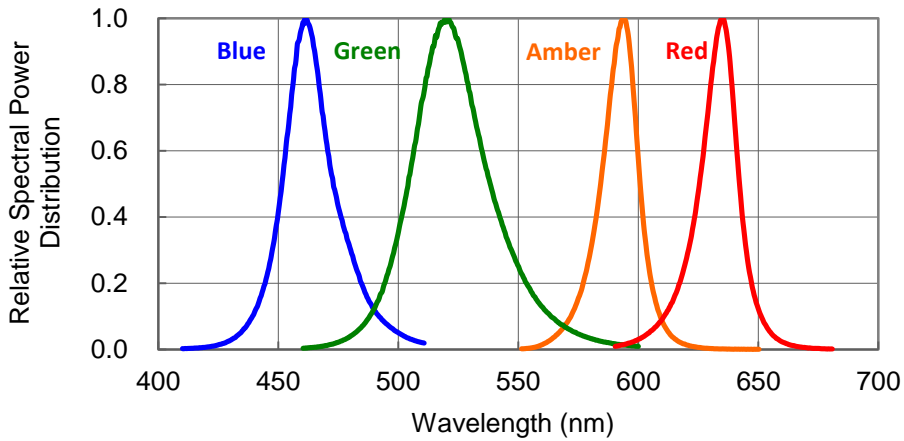

Forward Current Characteristics, $T_j = 25^\circ\text{C}$

1. Forward Voltage vs. Forward Current

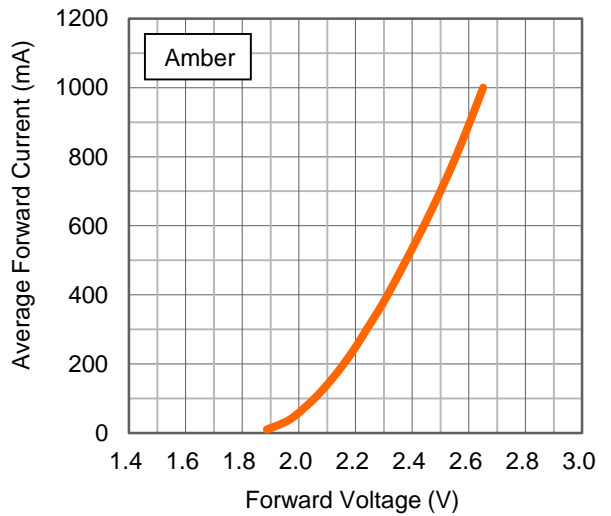
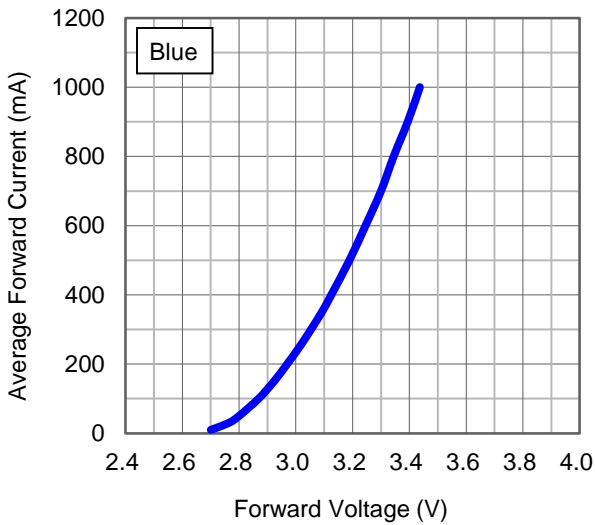
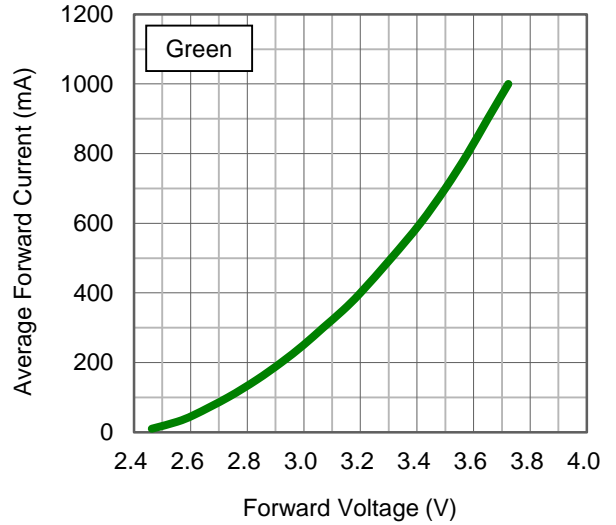
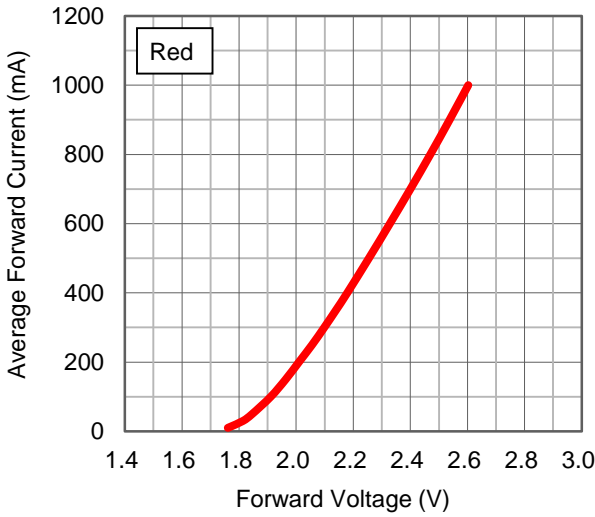

Forward Current Characteristics, $T_j = 25^\circ\text{C}$

2. Forward Current vs. Normalized Relative Luminous Flux

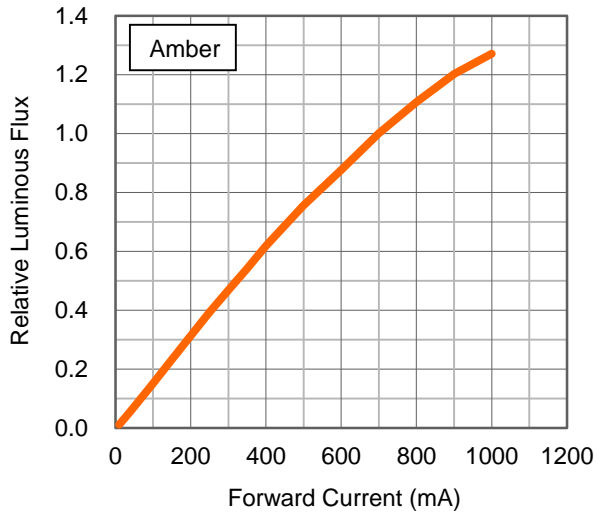
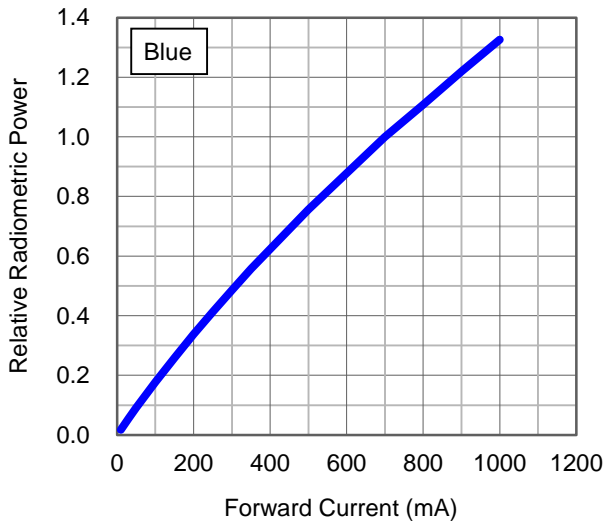
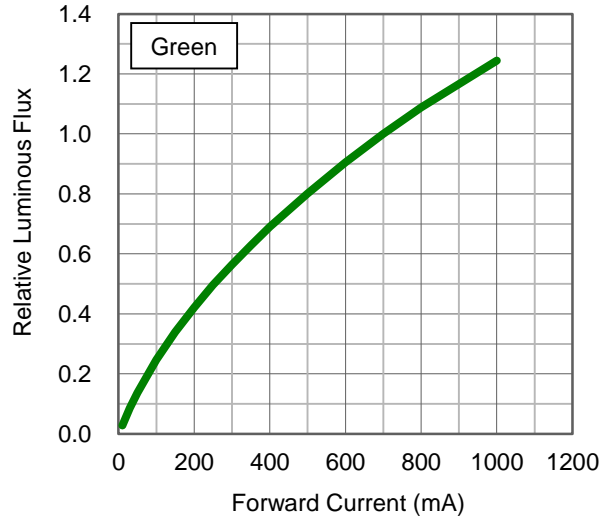
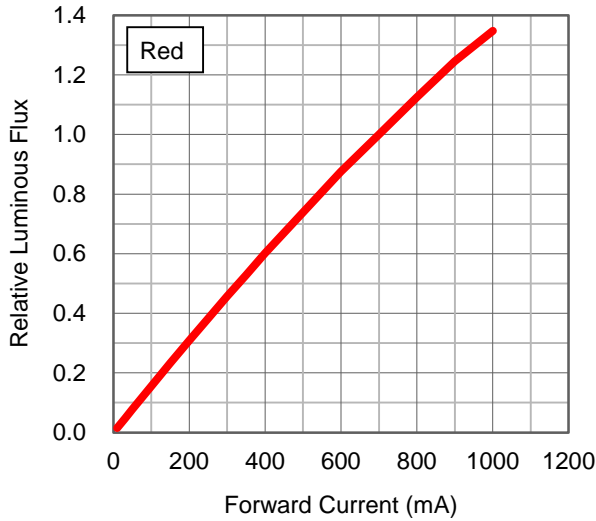

Forward Current Characteristics, $T_j = 25^\circ\text{C}$

3. Forward Current vs. Dominant Wavelength Shift

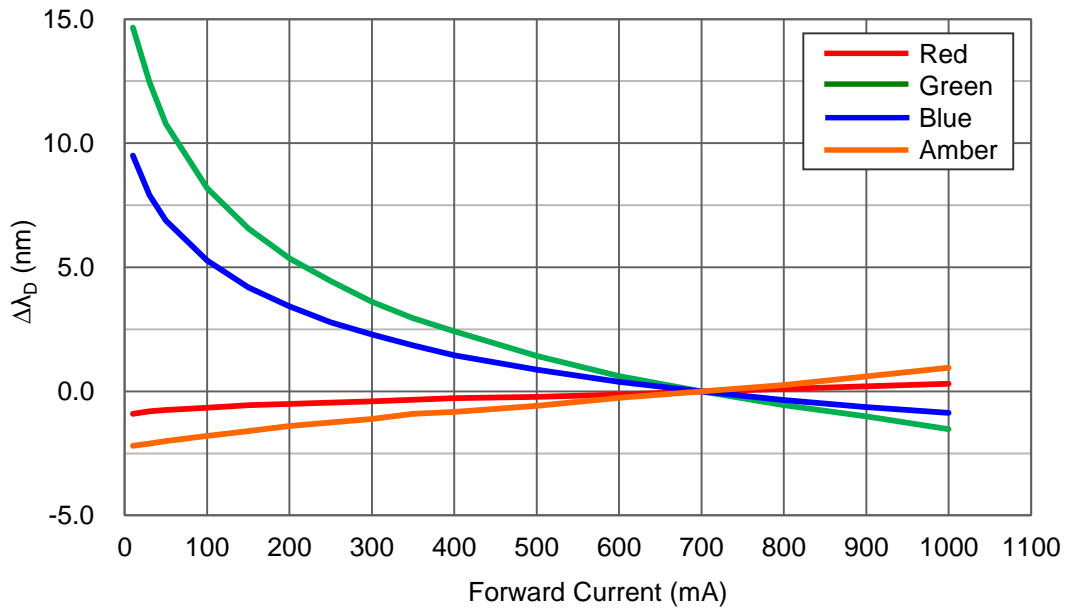

Junction Temperature Relative Characteristics

1. Junction Temperature vs. Relative Light Output at 700mA

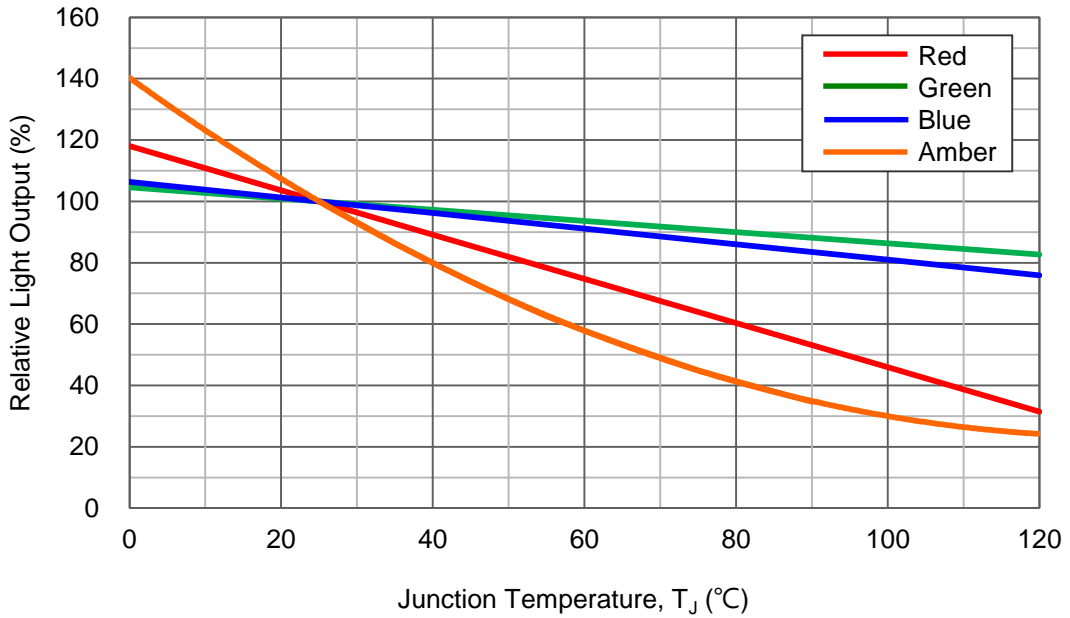

2. Junction Temperature vs. Relative Forward Voltage at 700mA

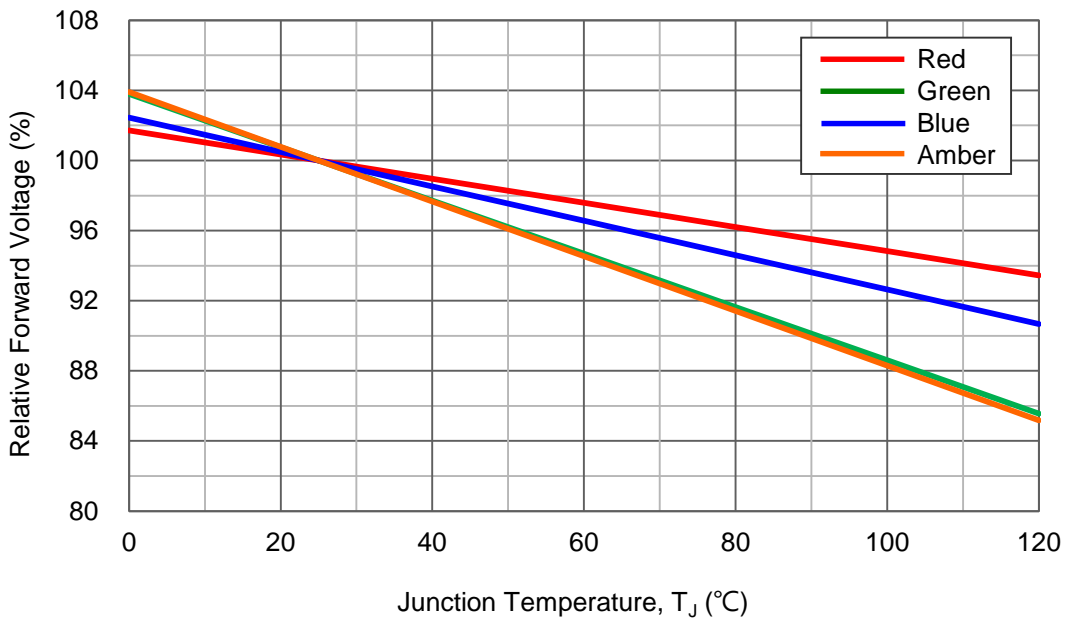

Junction Temperature Relative Characteristics

3. Junction Temperature vs. Dominant Wavelength Shift at 700mA

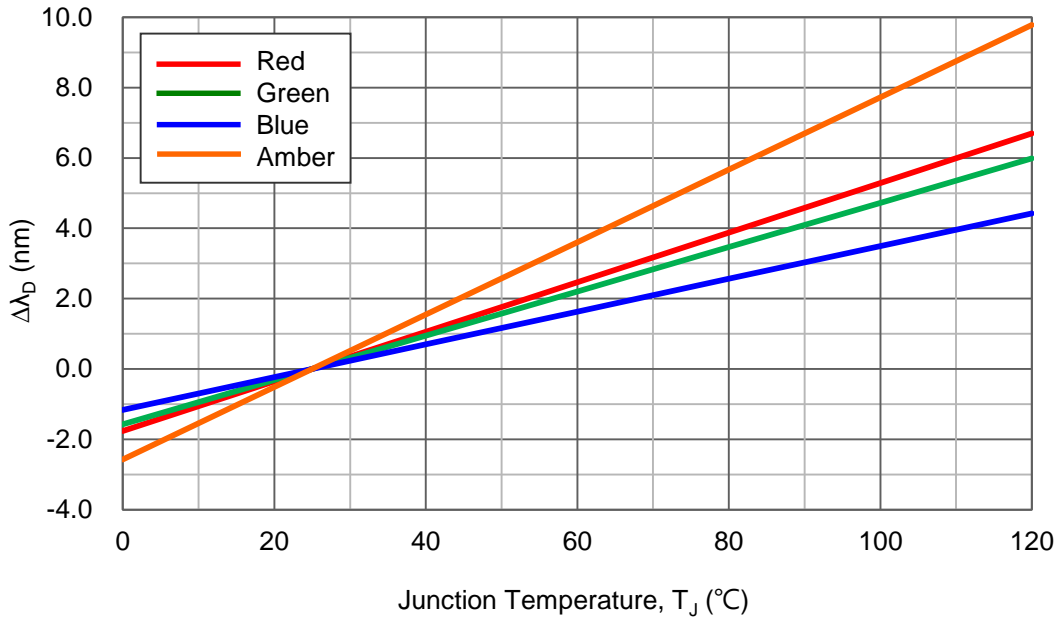

Board Temperature vs. Maximum Forward Current

Maximum Forward Current for 4 chip operated

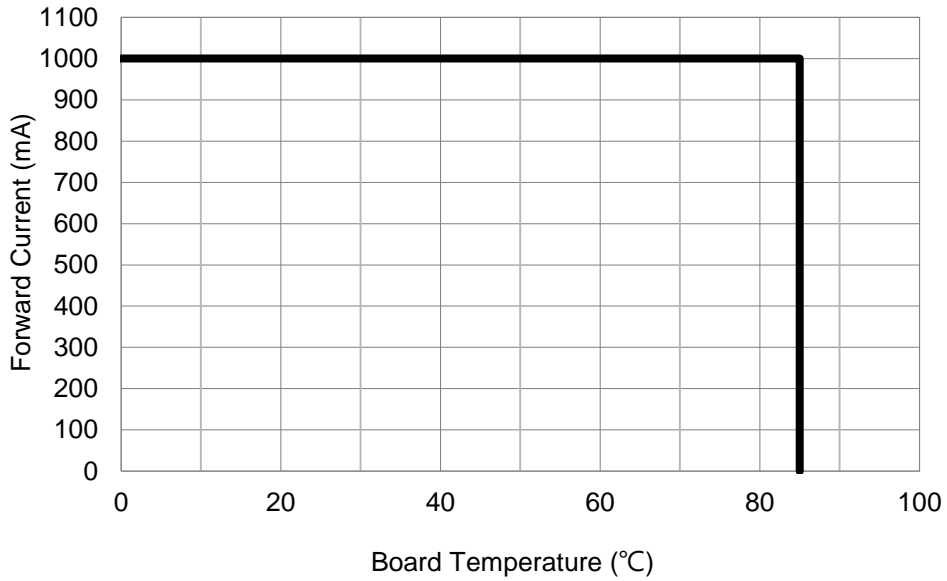

Typical Representative Spatial Radiation Pattern

Lambertian Radiation Pattern

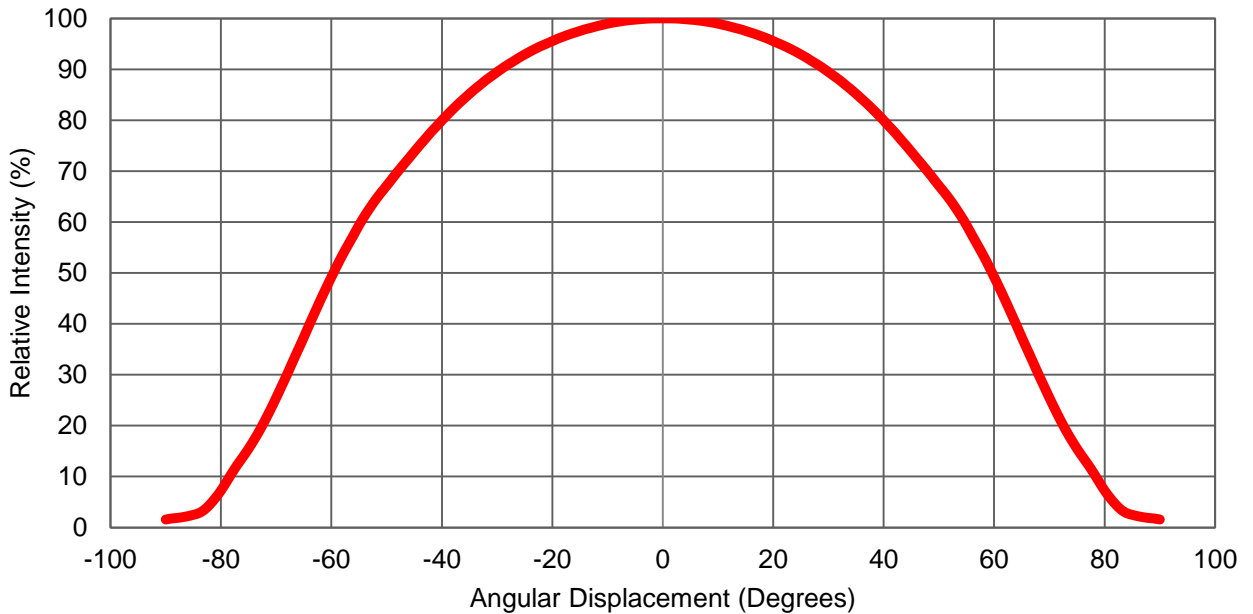

Moisture Sensitivity Level – JEDEC Level 1

Level	Floor Life		Soak Requirements			
			Standard		Accelerated Environment	
	Time	Conditions	Time (hours)	Conditions	Time (hours)	Conditions
1	Unlimited	≤30°C / 85% RH	168 +5/-0	85°C / 85% RH	NA	NA

- The standard soak time includes a default value of 24 hours for semiconductor manufacture's exposure time (MET) between bake and bag and includes the maximum time allowed out of the bag at the distributor's facility.
- Table below presents the moisture sensitivity level definitions per IPC/JEDEC's J-STD-020C.

Level	Floor Life		Soak Requirements			
			Standard		Accelerated Environment	
	Time	Conditions	Time (hours)	Conditions	Time (hours)	Conditions
1	Unlimited	≤30°C / 85% RH	168 +5/-0	85°C / 85% RH	NA	NA
2	1 year	≤30°C / 60% RH	168 +5/-0	85°C / 60% RH	NA	NA
2a	4 weeks	≤30°C / 60% RH	696 +5/-0	30°C / 60% RH	120 +1/-0	60°C / 60% RH
3	168 hours	≤30°C / 60% RH	192 +5/-0	30°C / 60% RH	40 +1/-0	60°C / 60% RH
4	72 hours	≤30°C / 60% RH	96 +2/-0	30°C / 60% RH	20 +0.5/-0	60°C / 60% RH
5	48 hours	≤30°C / 60% RH	72 +2/-0	30°C / 60% RH	15 +0.5/-0	60°C / 60% RH
5a	24 hours	≤30°C / 60% RH	48 +2/-0	30°C / 60% RH	10 +0.5/-0	60°C / 60% RH
6	Time on Label (TOL)	≤30°C / 60% RH	Time on Label (TOL)	30°C / 60% RH	NA	NA

Qualification Reliability Testing

Stress Test	Stress Conditions	Stress Duration	Failure Criteria
Room Temperature Operating Life (RTOL)	25°C, $I_F = \text{max DC}$ (Note 1)	1000 hours	Note 2
Wet High Temperature Storage Life (WHTSL)	85°C/85%RH, non-operating	1000 hours	Note 2
High Temperature Storage Life (HTSL)	110°C, non-operating	1000 hours	Note 2
Low Temperature Storage Life (LTSL)	-40°C, non-operating	1000 hours	Note 2
Non-operating Temperature Cycle (TMCL)	-40°C to 120°C, 30 min. dwell, <5 min. transfer	200 cycles	Note 2
Mechanical Shock	1500 G, 0.5 msec. pulse, 5 shocks each 6 axis		Note 3
Natural Drop	On concrete from 1.2 m, 3X		Note 3
Variable Vibration Frequency	10-2000-10 Hz, log or linear sweep rate, 20 G about 1 min., 1.5 mm, 3X/axis		Note 3
Solder Heat Resistance (SHR)	260°C ± 5°C, 10 sec.		Note 3
Solderability	Steam age for 16 hrs., then solder dip at 260°C for 5 sec.		Solder coverage on lead

Notes:

1. Depending on the maximum derating curve.
2. Criteria for judging failure

Item	Test Condition	Criteria for Judgement	
		Min.	Max.
Forward Voltage (V_F)	$I_F = \text{max DC}$	--	Initial Level x 1.1
Luminous Flux or Radiometric Power (Φ_V)	$I_F = \text{max DC}$	Initial Level x 0.7	--
Reverse Current (I_R)	$V_R = 5V$	--	50 μA

* The test is performed after the LED is cooled down to the room temperature.

3. A failure is an LED that is open or shorted.

Recommended Solder Pad Design

Solder Pad

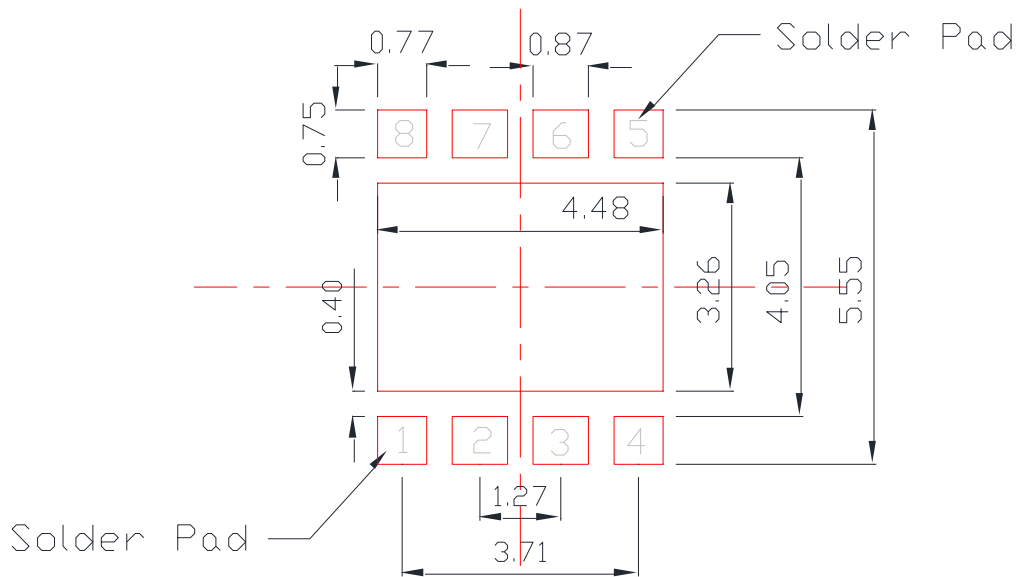

Solder Resist

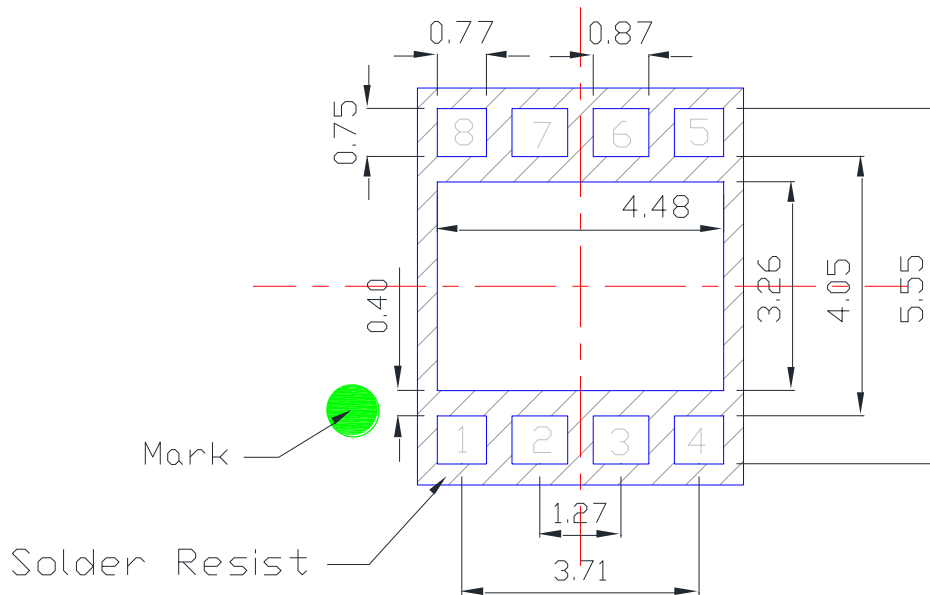

- All dimensions are in millimeters.
- Electrical isolation is required between Slug and Solder Pad.

Reflow Soldering Condition

Profile Feature	Sn-Pb Eutectic Assembly	Pb-Free Assembly
Average Ramp-Up Rate (T_{Smax} to T_p)	3°C / second max.	3°C / second max.
Preheat <ul style="list-style-type: none"> – Temperature Min (T_{Smin}) – Temperature Max (T_{Smax}) – Time (t_{Smin} to t_{Smax}) 	100°C 150°C 60-120 seconds	150°C 200°C 60-180 seconds
Time maintained above: <ul style="list-style-type: none"> – Temperature (T_L) – Time (t_L) 	183°C 60-150 seconds	217°C 60-150 seconds
Peak/Classification Temperature (T_p)	240°C	260°C
Time Within 5°C of Actual Peak Temperature (t_p)	10-30 seconds	20-40 seconds
Ramp-Down Rate	6°C/second max.	6°C/second max.
Time 25°C to Peak Temperature	6 minutes max.	8 minutes max.

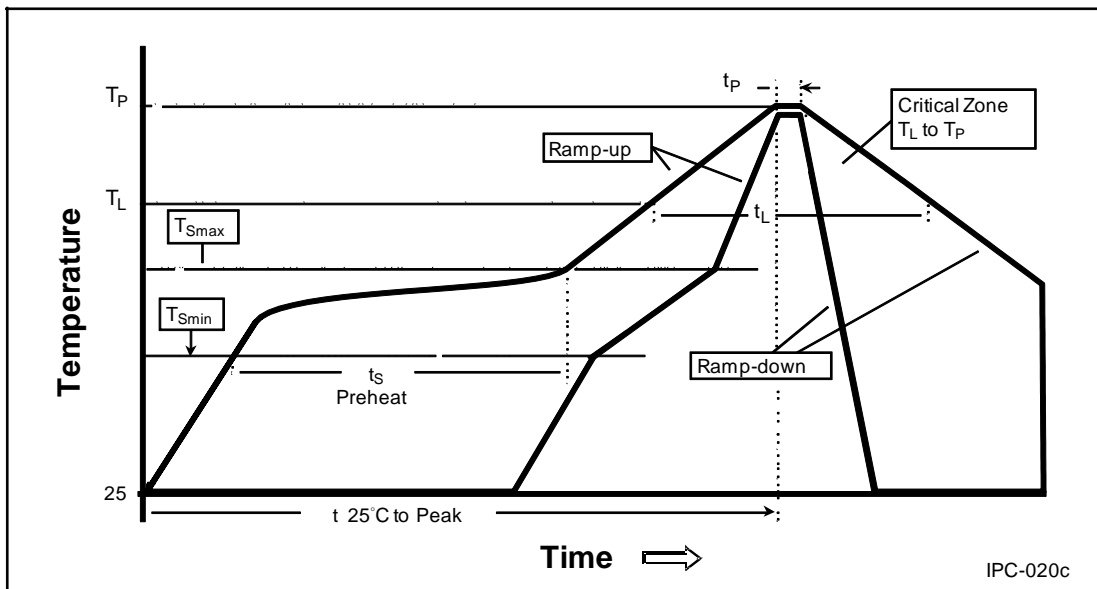

- We recommend using the M705-S101-S4 solder paste from SMIC (Senju Metal Industry Co., Ltd.) for lead-free soldering.
- Do not use solder pastes with post reflow flux residue > 47%. (58Bi-42Sn eutectic alloy, etc) This kind of solder pastes may cause a reliability problem to LED.
- All temperatures refer to topside of the package, measured on the package body surface.
- Repairing should not be done after the LEDs have been soldered. When repairing is unavoidable, a double-head soldering iron should be used. It should be confirmed beforehand whether the characteristics of the LEDs will or will not be damaged by repairing.
- Reflow soldering should not be done more than three times.
- When soldering, do not put stress on the LEDs during heating.
- After soldering, do not warp the circuit board.

Emitter Reel Packaging

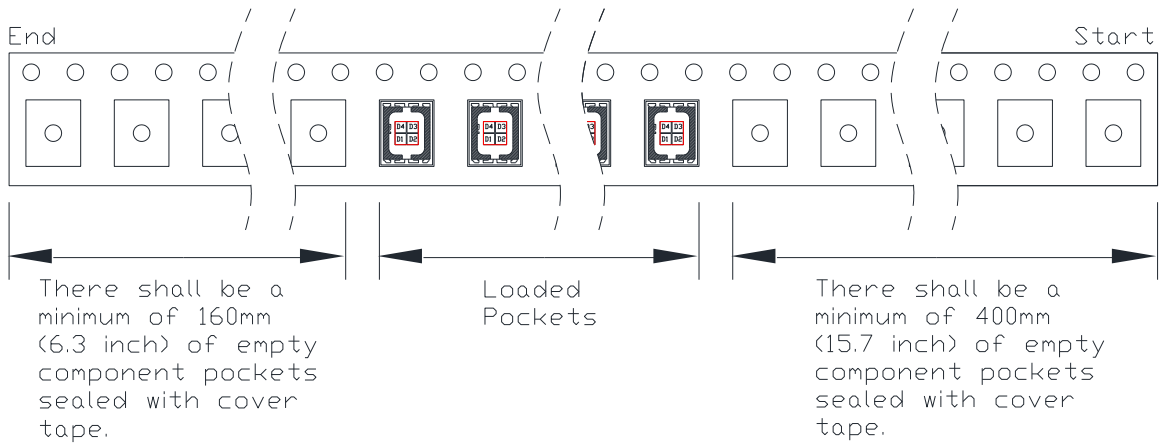
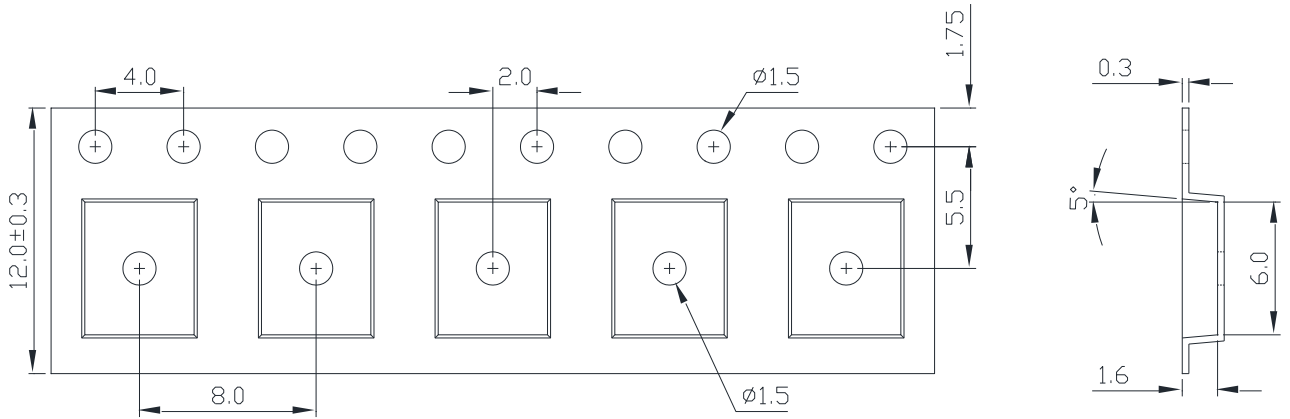

Notes:

1. Drawing not to scale.
2. All dimensions are in millimeters.
3. Unless otherwise indicated, tolerances are $\pm 0.10\text{mm}$.

Emitter Reel Packaging

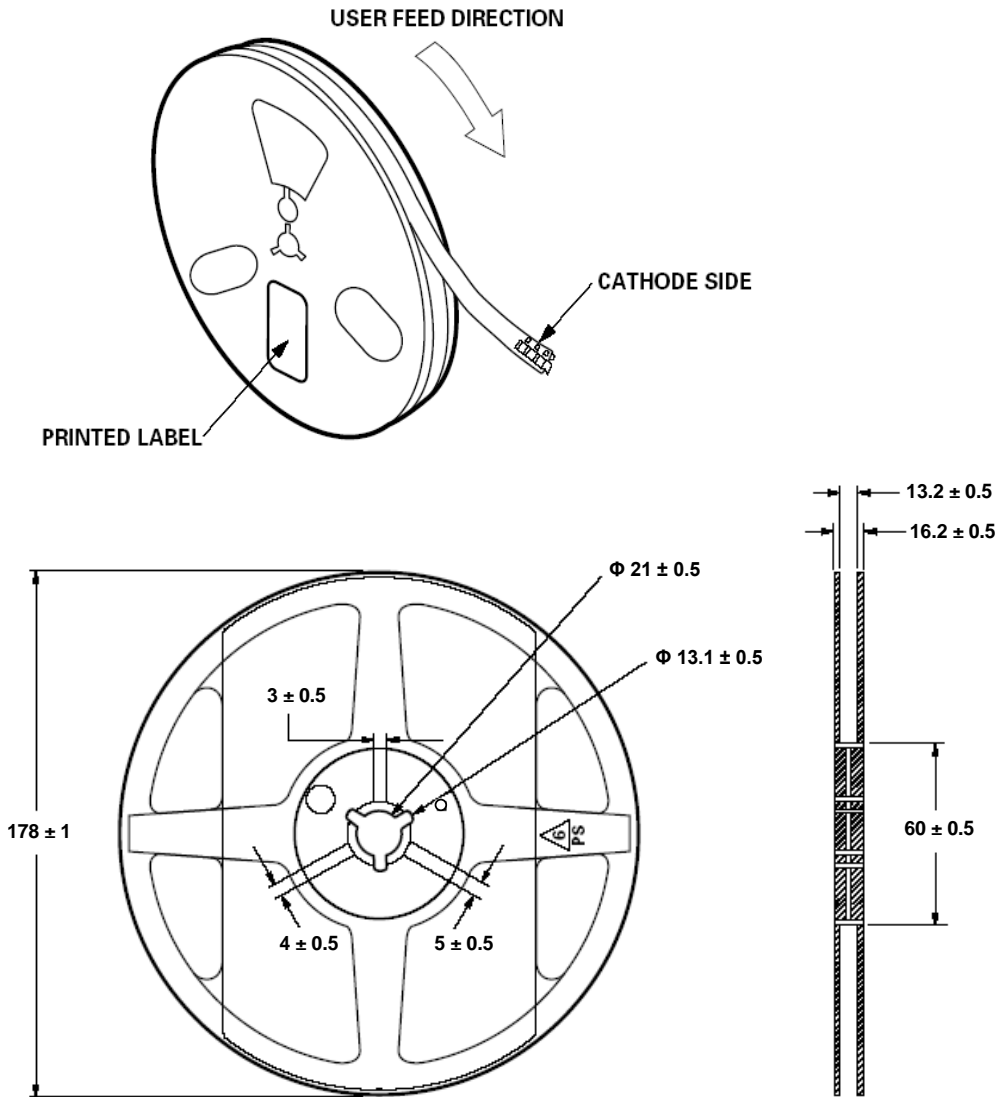

Notes:

1. Empty component pockets sealed with top cover tape.
2. 250 or 500 pieces per reel.
3. Drawing not to scale.
4. All dimensions are in millimeters.

Precaution for Use

- **We recommend using the M705-S101-S4 solder paste from SMIC (Senju Metal Industry Co., Ltd.) for lead-free soldering.**
- **Do not use solder pastes with post reflow flux residue>47%. (58Bi-42Sn eutectic alloy, etc) This kind of solder pastes may cause a reliability problem to LED.**
- Any mechanical force or any excess vibration shall not be accepted to apply during cooling process to normal temperature after soldering.
- Please avoid rapid cooling after soldering.
- Components should not be mounted on warped direction of PCB.
- Repairing should not be done after the LEDs have been soldered. When repairing is unavoidable, a heat plate should be used. It should be confirmed beforehand whether the characteristics of the LEDs will or will not be damaged by repairing.
- This device should not be used in any type of fluid such as water, oil, organic solvent and etc. When cleaning is required, isopropyl alcohol should be used.
- When the LEDs are illuminating, operating current should be decided after considering the package maximum temperature.
- The appearance, specifications and flux bin of the product may be modified for improvement without notice. Please refer to the below website for the latest datasheets.
<http://www.prolightopto.com/>

Handling of Lens LEDs

Notes for handling of lens LEDs

- Please do not use a force of over 1kgf impact or pressure on the lens, otherwise it will cause a catastrophic failure.
- The LEDs should only be picked up by making contact with the sides of the LED body.
- Avoid touching the lens especially by sharp tools such as Tweezers.
- Avoid leaving fingerprints on the lens.
- Please store the LEDs away from dusty areas or seal the product against dust.
- Please do not mold over the lens with another resin. (epoxy, urethane, etc)

