

### ■ Features

- Higher Luminous Output
- 5φ Dome Standard Directivity
- Superior Weather-resistance
- Long Lifetime Operation
- Water Clear Type

### ■ Applications

- Electronic Signs And Signals
- Illuminations
- Reading Lamps / Emergency Lighting
- Other Lighting

### ■ Outline Dimension

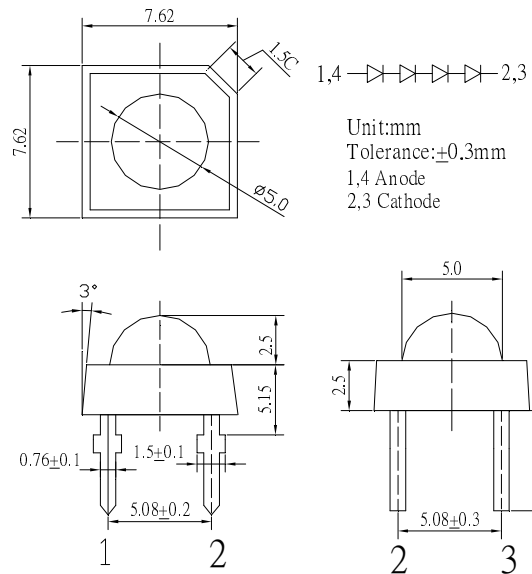

### ■ Absolute Maximum Rating

(Ta=25°C)

Item	Symbol	Value	Unit
DC Forward Current	I <sub>F</sub>	20	mA
Pulse Forward Current*	I <sub>FP</sub>	40	mA
Reverse Voltage	V <sub>R</sub>	5	V
Power Dissipation	P <sub>D</sub>	272	mW
Operating Temperature	T <sub>opr</sub>	-30 ~ +85	°C
Storage Temperature	T <sub>stg</sub>	-40 ~ +100	°C
Lead Soldering Temperature	T <sub>sol</sub>	260°C/5sec	-

\*Pulse width Max 10ms , Duty ratio max 1/10

### ■ Directivity

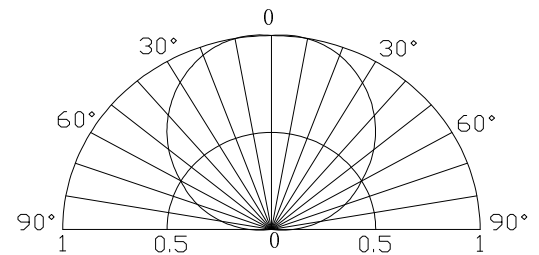

### ■ Electrical -Optical Characteristics

(Ta=25°C)

Item	Symbol	Condition	Min.	Typ.	Max.	Unit
DC Forward Voltage	V <sub>F</sub>	I <sub>F</sub> =20mA	11.6	12.0	13.6	V
DC Reverse Current	I <sub>R</sub>	V <sub>R</sub> =5V	-	-	10	μA
Luminous Flux	Φ <sub>v</sub>	I <sub>F</sub> =20mA	28	30	-	lm
Color Temperature	CCT	I <sub>F</sub> =20mA	-	6500	-	K
Chromaticity Coordinate*2	x	I <sub>F</sub> =20mA	-	0.31	-	
	y	I <sub>F</sub> =20mA	-	0.33	-	
50% Power Angle	2θ <sub>1/2</sub>	I <sub>F</sub> =20mA	-	120	-	deg

\*1 Tolerance of chromaticity coordinates ±10%

\*2 Tolerance of luminous flux is ±15%