



**BRIGHTTEK**  
**BRIGHTTEK (EUROPE) LIMITED**

*Brighten up The World With LED!*



ISO/TS 16949:2009



BS EN ISO 14001:2004



QC 080000 IECQ HSPM

## PRODUCT DATASHEET



- ▶ PLCC8 SMD
- ▶ 3735 1.8t Series
- ▶ Warm White / Red / Green / Blue

WRGB

NOM61S07



Release Date: 04 June 2022 Version: A1.1



### 3735 1.8t Series

**RoHS Compliant**



#### FEATURES (Warm White/Red/Green/Blue):

- **Package:** PLCC8 WRGB Top View SMD Package
- **Forward Current:** 20/20/20/20mA \*
- **Forward Voltage (typ.):** 3.1/2.2/3.1/3.1V
- **Luminous Flux (typ.):** 1900/750/1500/370mcd@20mA
- **Colour:** Warm White/Red/Green/Blue
- **CCT/Wavelength:** 3000K/622/525/467nm
- **Viewing angle:** 120°
- **Materials:**
  - Die: InGaN/AlGaInP/InGaN/InGaN
  - Resin: Silicon (Yellow/White Diffused)
- **Operating Temperature:** -40~+85°C
- **Storage Temperature:** -40~+100°C
- **ESD:** 1000V (HBM)
- **Grouping parameters:**
  - Forward voltage
  - Luminous intensity
  - CIE Chromaticity/Dominant Wavelength
- **Soldering methods:** Reflow soldering
- **Preconditioning:** MSL 5a according to JEDEC
- **Packing:** 12mm tape with max.1000pcs/reel, ø180mm (7")

\* In the order of Natural White/Red/Green/Blue.

#### APPLICATIONS:

- LED Display
- Switch Light
- 3C Application
- Decoration Lighting
- Amusement Lighting
- Architecture Lighting
- LED Light Strip

**CHARACTERISTICS:**

---

## Absolute Maximum Characteristics (Ta=25°C)

Parameter	Symbol	Ratings	Unit
Forward Current	I <sub>F</sub>	30	mA
Pulse Forward Current (duty 1/10; width 0.1ms)	I <sub>MAX</sub>	70	mA
Reverse Voltage	V <sub>R</sub>	5	V
Reverse Current @5V	I <sub>R</sub>	10	μA
Electrostatic Discharge (HBM)	ESD	1000	V
Junction Temperature	T <sub>j</sub>	110	°C
Soldering Temperature	T <sub>SOL</sub>	260	°C
Operating Temperature	T <sub>OPR</sub>	-40~+85	°C
Storage Temperature	T <sub>STG</sub>	-40~+100	°C

## Electrical &amp; Optical Characteristics (Ta=25°C)

Parameter	Symbol	Values			Unit	Test Condition
		Min.	Typ.	Max.		
White - Forward Voltage	V <sub>F</sub>	2.8	---	3.4	V	I <sub>F</sub> =20mA
White- Luminous Intensity	I <sub>v</sub>	1100	1900	3000	mcd	I <sub>F</sub> =20mA
White Chromaticity Coordinates	X	---	0.4340	---	---	I <sub>F</sub> =20mA
	Y	---	0.4030	---		
Colour Temperature	CCT	---	3000	---	K	I <sub>F</sub> =20mA
Red - Forward Voltage	V <sub>F</sub>	1.9	---	2.5	V	I <sub>F</sub> =20mA
Red - Luminous Intensity	I <sub>v</sub>	440	750	1300	mcd	I <sub>F</sub> =20mA
Red - Wavelength	W <sub>P</sub>	618	---	628	nm	I <sub>F</sub> =20mA
Green - Forward Voltage	V <sub>F</sub>	2.8	---	3.4	V	I <sub>F</sub> =20mA
Green - Luminous Intensity	I <sub>v</sub>	850	1500	2050	mcd	I <sub>F</sub> =20mA
Green - Wavelength	W <sub>P</sub>	520	---	530	nm	I <sub>F</sub> =20mA
Blue - Forward Voltage	V <sub>F</sub>	2.8	---	3.4	V	I <sub>F</sub> =20mA
Blue - Luminous Intensity	I <sub>v</sub>	210	370	620	mcd	I <sub>F</sub> =20mA
Blue - Wavelength	W <sub>P</sub>	460	---	475	nm	I <sub>F</sub> =20mA
RGB Mix Chromaticity Coordinates	X	---	0.2580	---	---	I <sub>F</sub> =20mA
	Y	---	0.2450	---		
Viewing Angle	2θ <sub>1/2</sub>	---	120	---	deg	I <sub>F</sub> =20mA

- Luminous intensity (I<sub>v</sub>) ±10%, Forward Voltage (V<sub>F</sub>) ±0.1V, Viewing angle(2θ<sub>1/2</sub>) ±5%, Wavelength (λ) ±1nm.
- The bin will be amended to maintain bin centralization. The Luminous Intensity will be 1.3 times per bin and the Dominant Wavelength is 5nm per R/G/B bin.

## OUTLINE DIMENSION:

Package Dimension:

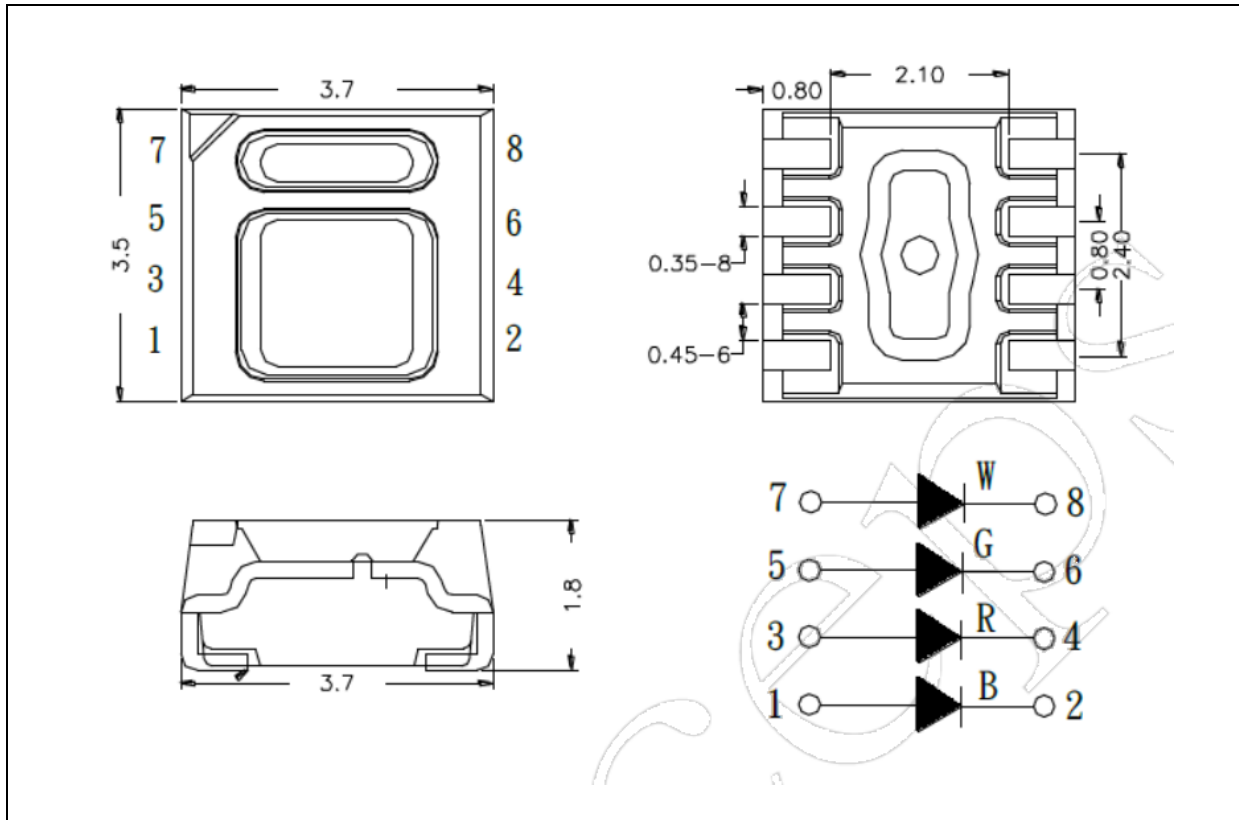

1. All dimensions are in millimetre (mm).
2. Tolerance  $\pm 0.1\text{mm}$ , unless otherwise noted.

Recommended Soldering Pad Dimension:

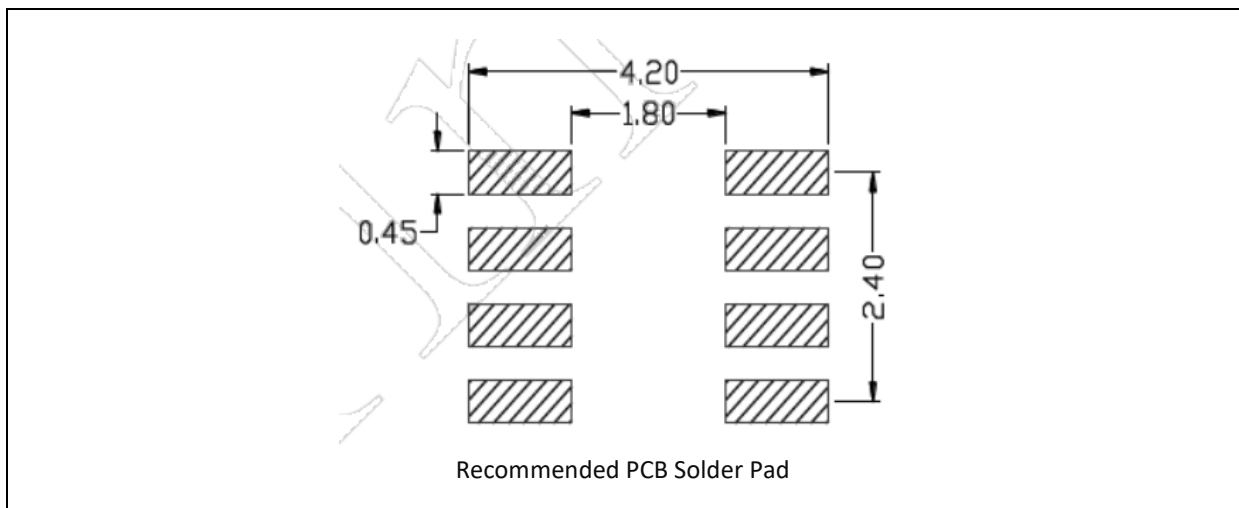

1. Dimensions are in millimetre (mm).
2. Tolerance  $\pm 0.1\text{mm}$  with angle tolerance  $\pm 0.5^\circ$ .

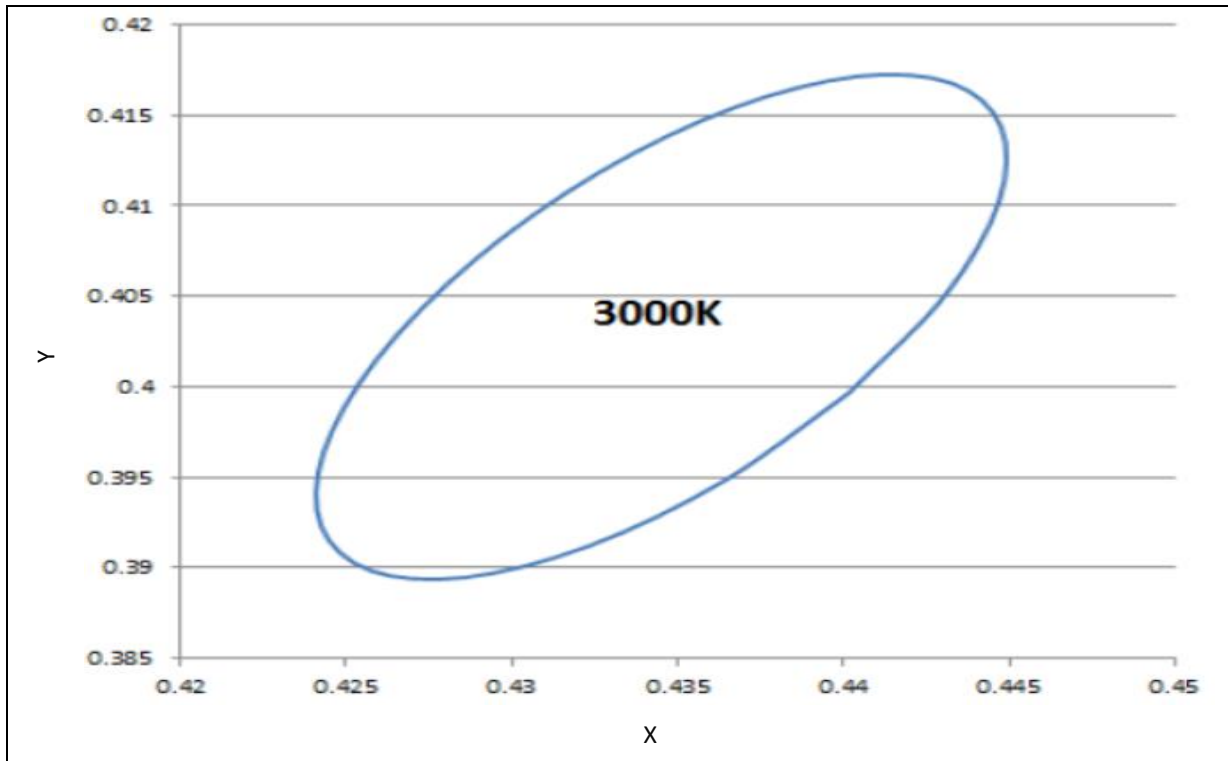
**CIE CHROMATICITY DIAGRAM (WHITE):**

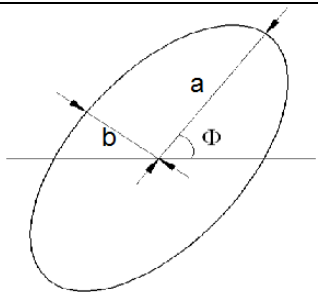
**Chromaticity Coordinates Classifications ( $I_F = 65\text{mA}$ ):**

	Code	Centre		Radius		Angle
		X	Y	a	b	$\Phi$
	3000K 5 STEP	0.4345	0.4033	0.00321	0.00135	56.9675
g11: 416226.3809	g12: -207671.6569		g22: 231868.7753			

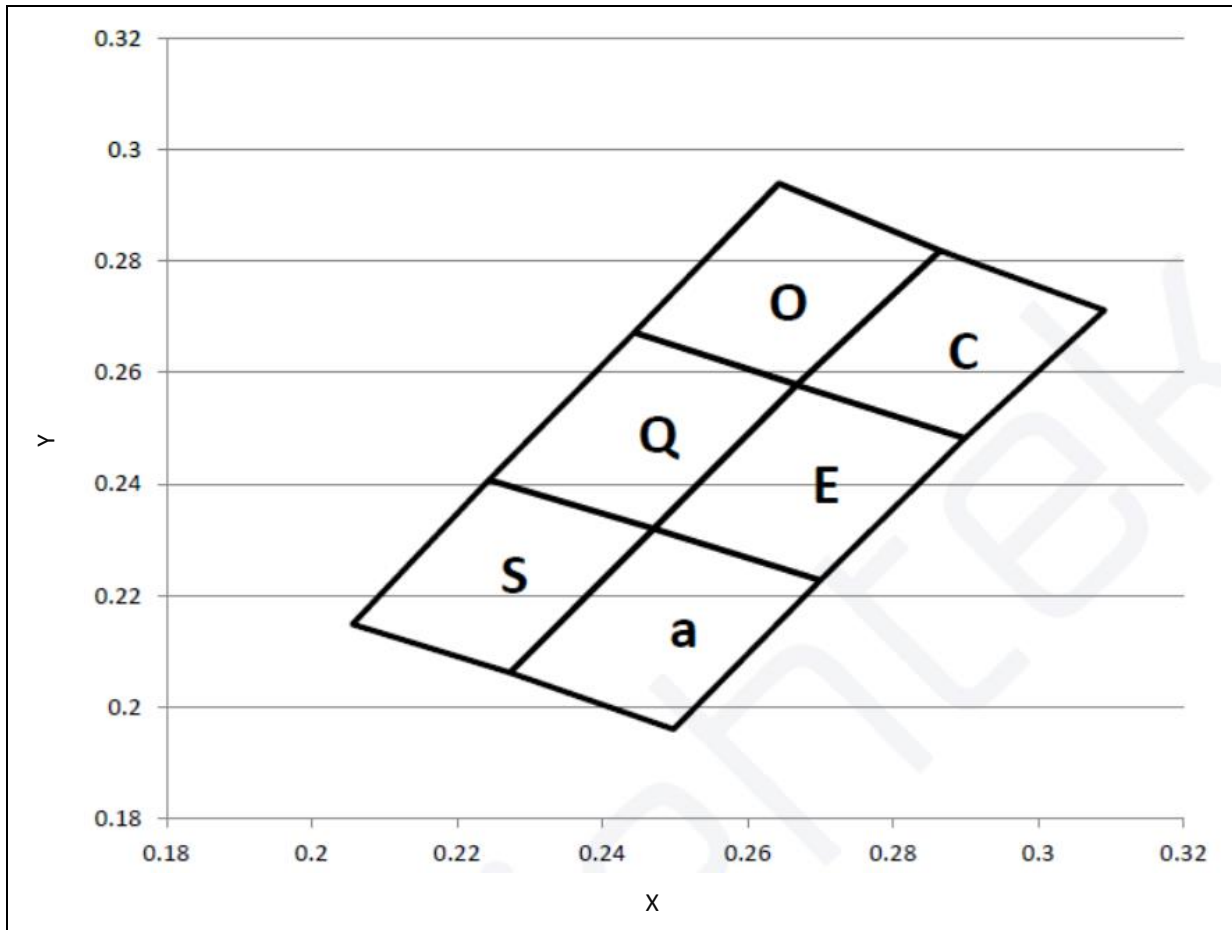
## CIE CHROMATICITY DIAGRAM (RGB):



### Chromaticity Coordinates Classifications:

	1		2		3		4	
	X	Y	X	Y	X	Y	X	Y
O	0.2444	0.2672	0.2643	0.2940	0.2865	0.2819	0.2667	0.2578
C	0.2865	0.2819	0.3019	0.2712	0.2899	0.2482	0.2667	0.2578
Q	0.2444	0.2672	0.2244	0.2407	0.2471	0.2320	0.2669	0.2579
E	0.2667	0.2578	0.2899	0.2482	0.2700	0.2227	0.2470	0.2320
S	0.2244	0.2407	0.2056	0.2148	0.2273	0.2061	0.2471	0.2320
a	0.2471	0.2320	0.2273	0.2061	0.2498	0.1959	0.2700	0.2227

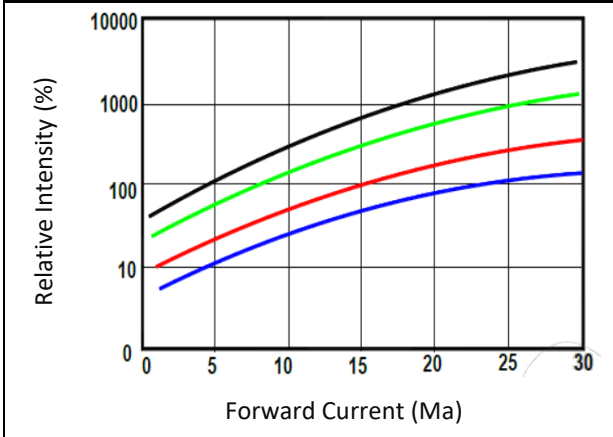
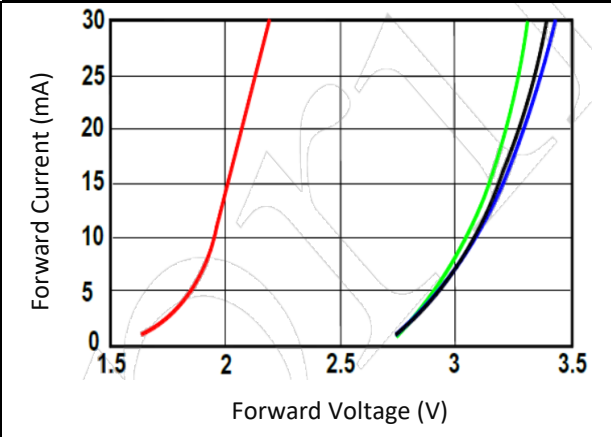
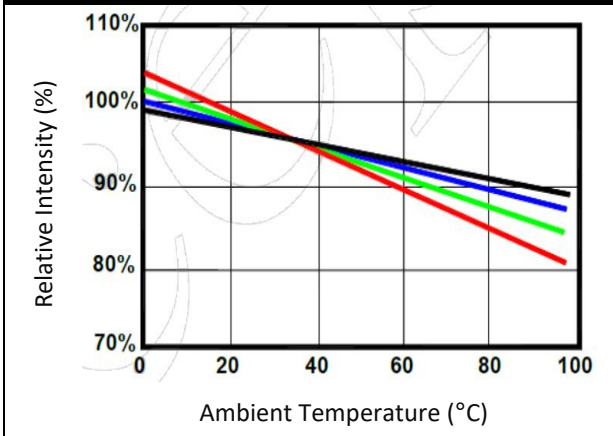
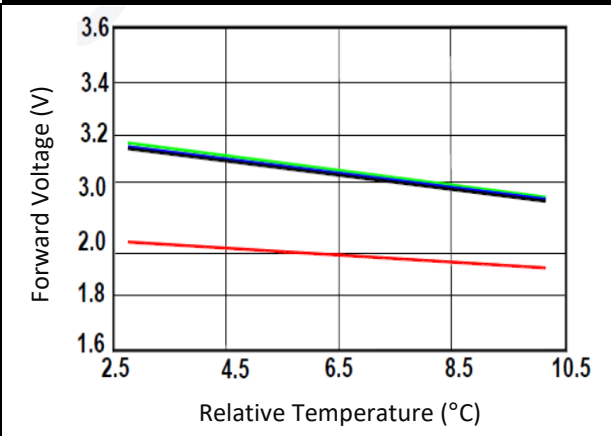
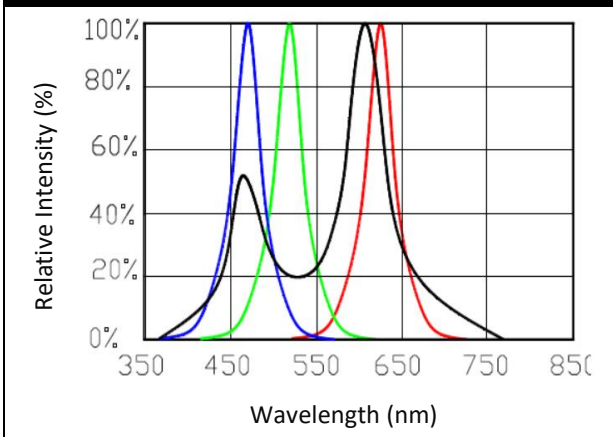
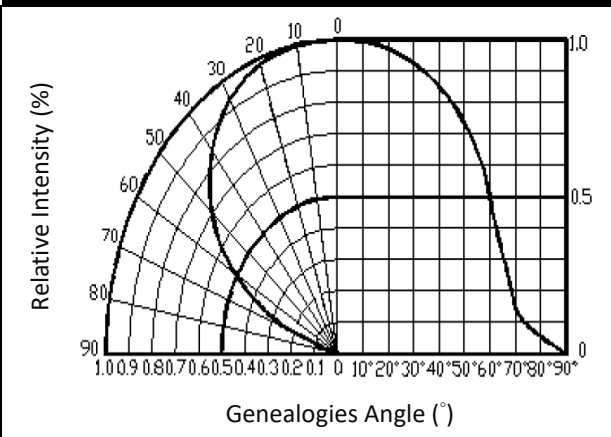
**ELECTRO-OPTICAL CHARACTERISTICS:**
**Relative Intensity v.s. Forward Current**

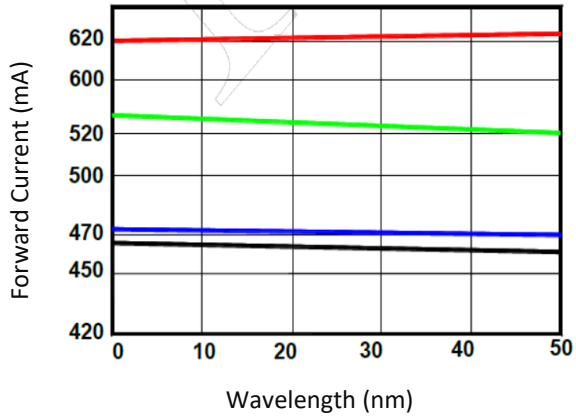
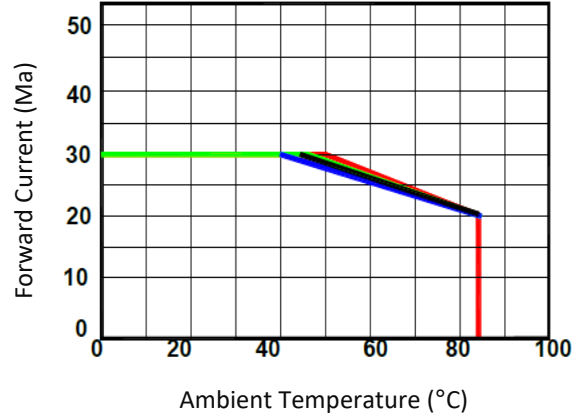
**Forward Current v.s. Forward Voltage**

**Relative Intensity v.s. Ambient Temperature**

**Forward Voltage v.s. Relative Temperature**

**Relative Spectral Distribution**

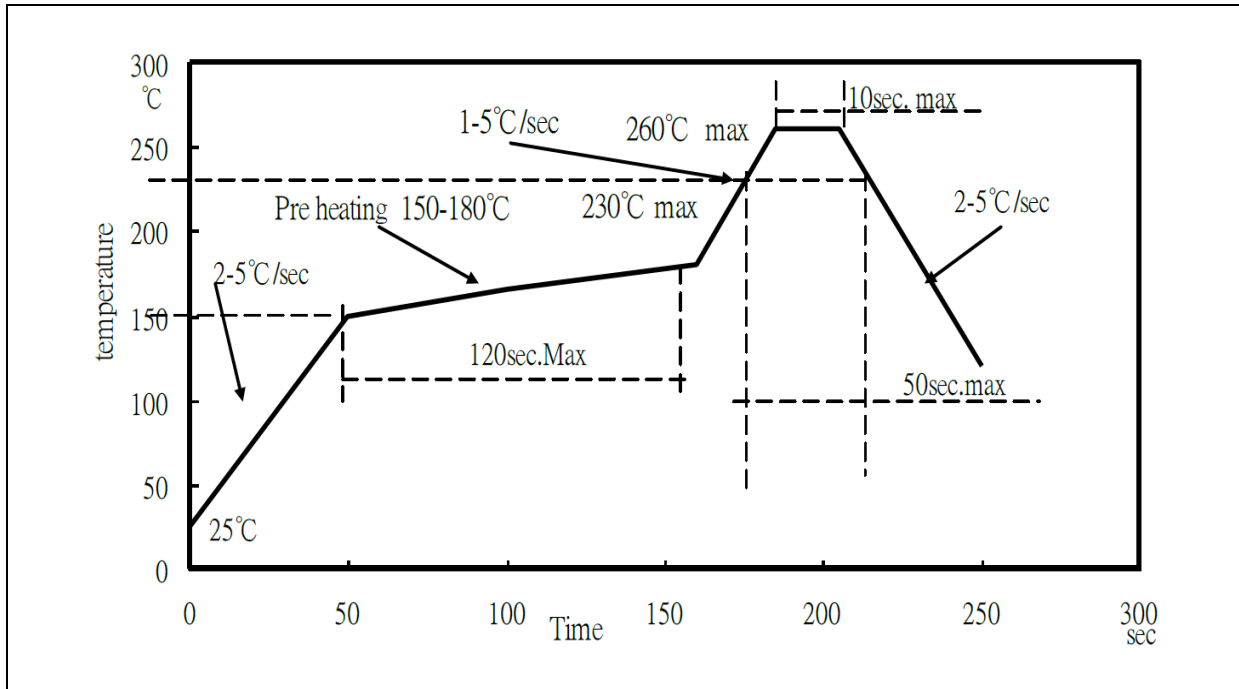
**Directive Radiation**

**ELECTRO-OPTICAL CHARACTERISTICS:**
**Wavelength Shift v.s. Forward Current**

**Maximum Current v.s. Ambient Temperature**



## RECOMMENDED SOLDERING PROFILE:

Lead-free Solder:



Note:

1. Maximum reflow soldering: 2 times.
2. Recommended reflow temperature is 240°C; the maximum soldering temperature should be limited to 260°C.
3. Before, during, and after soldering, should not apply stress on the components and PCB board.

**PACKING SPECIFICATION:**

Reel Dimension:

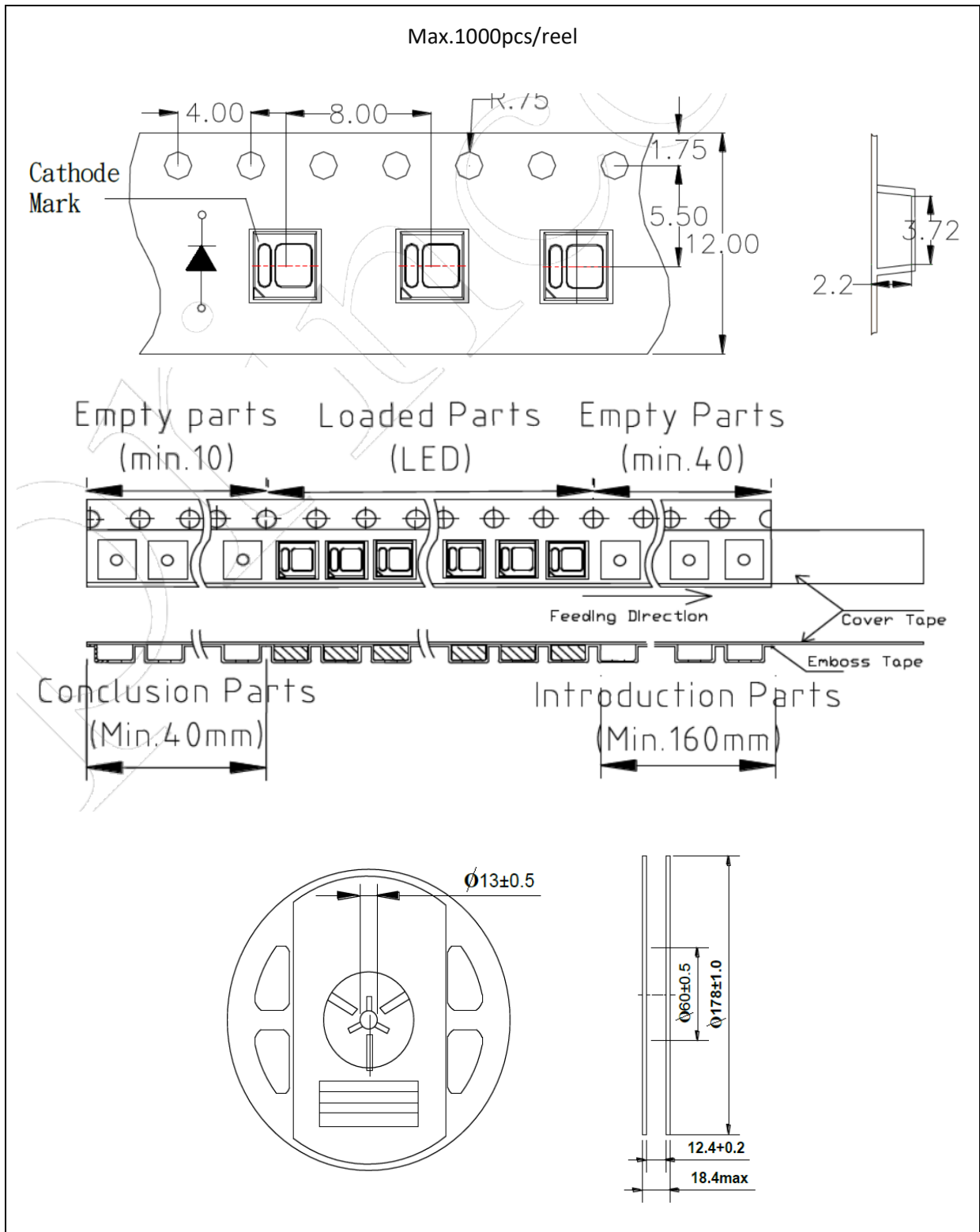

## PRECAUTIONS OF USE:

---

### Storage:

It is recommended to store the products in the following conditions:

- Humidity: 60% R.H. Max.
- Temperature: 5°C~30°C (41°F ~86°F).

Shelf life in sealed bag: 12 months at 5°C~30°C and <60% R.H.

Once the package is opened, the products should be used within 48 hours. Otherwise, they should be kept in a damp-proof box with desiccating agent <10% R.H. and apply baking.

### Baking:

It is recommended to bake the LED before soldering if the pack has been unsealed for longer than 24hrs.

The suggested baking conditions are as followings:

- 60±3°C x 6hrs and <5%RH, taped / reel package.

It's normal to see slight color fading of carrier (light yellow) after baking in process.

### Testing Circuit:

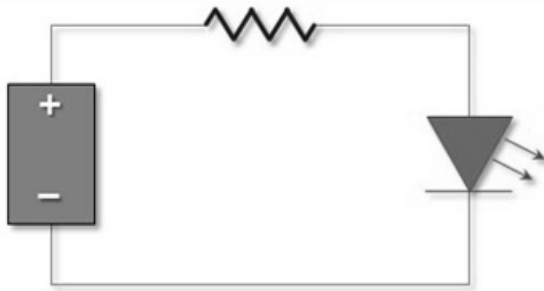

Must apply resistor(s) for protection (over current proof).

### Cleaning:

Use alcohol-based cleaning solvents such as isopropyl alcohol to clean the LED carrier / package. Avoid putting any stress force directly on to the LED lens.

### ESD (Electrostatic Discharge):

Static Electricity or power surge will damage the LED. Use of a conductive wrist band or anti-electrostatic glove is recommended when handling the LED all time. All devices, equipment, machinery, work tables, and storage racks must be properly grounded.

In the events of manual working in process, make sure the devices are well protected from ESD at any time.

**REVISION RECORD:**

---

Version	Date	Summary of Revision
A1.0	02/04/2019	Datasheet set-up.
A1.1	04/06/2022	New datasheet format.