

MPSA42 TRANSISTOR (NPN)

FEATURES

- High voltage

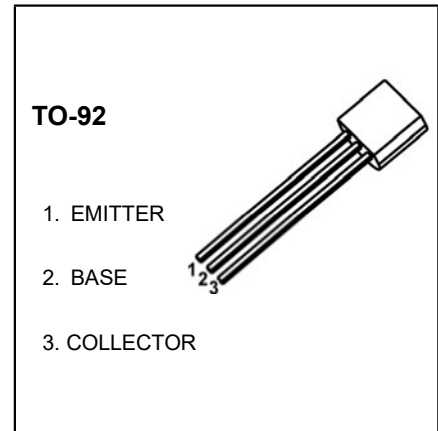

MARKING

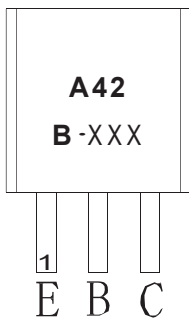

A42=Device code
 Solid dot=Green molding compound device,
 if none,the normal device
 Z=Rank of h_{FE}
 XXX=Code

Equivalent Circuit

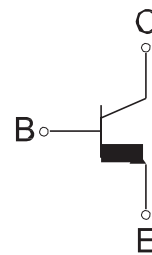

ORDERING INFORMATION

Part Number	Package	Packing Method	Pack Quantity
A42	TO-92	Bulk	1000pcs/Bag
A42-TA	TO-92	Tape	2000pcs/Box

MAXIMUM RATINGS ($T_a=25^\circ\text{C}$ unless otherwise noted)

Symbol	Parameter	Value	Unit
V_{CBO}	Collector-Base Voltage	310	V
V_{CEO}	Collector-Emitter Voltage	305	V
V_{EBO}	Emitter-Base Voltage	5	V
I_C	Collector Current -Continuous	200	mA
I_{CM}	Collector Current - Pulsed	500	mA
P_C	Collector Power Dissipation	625	mW
P_C	Collector Power Dissipation($T_c=25^\circ\text{C}$)	1.5	W
T_J, T_{stg}	Operation Junction and Storage Temperature Range	-55-150	$^\circ\text{C}$
$R_{\theta JA}$	Thermal Resistance, junction to Ambient	200	$^\circ\text{C} / \text{mW}$
$R_{\theta JC}$	Thermal Resistance, junction to Case	83.3	$^\circ\text{C} / \text{mW}$

$T_a=25\text{ }^{\circ}\text{C}$ unless otherwise specified

Parameter	Symbol	Test conditions	Min	Typ	Max	Unit
Collector-base breakdown voltage	$V_{(BR)CBO}$	$I_C=100\mu\text{A}, I_E=0$	310			V
Collector-emitter breakdown voltage	$V_{(BR)CEO}$	$I_C=1\text{mA}, I_B=0$	305			V
Emitter-base breakdown voltage	$V_{(BR)EBO}$	$I_E=100\mu\text{A}, I_C=0$	5			V
Collector cut-off current	I_{CBO}	$V_{CB}=200\text{V}, I_E=0$			0.1	μA
Emitter cut-off current	I_{EBO}	$V_{EB}=5\text{V}, I_C=0$			0.1	μA
DC current gain	$h_{FE(1)}$	$V_{CE}=10\text{V}, I_C=10\text{mA}$	40			
	$h_{FE(2)}$	$V_{CE}=10\text{V}, I_C=30\text{mA}$	40			
	$h_{FE(3)}$	$V_{CE}=10\text{V}, I_C=1.0\text{mA}$	25			
Collector-emitter saturation voltage	$V_{CE(sat)}$	$I_C=20\text{mA}, I_B=2\text{mA}$			0.5	V
Base-emitter saturation voltage	$V_{BE(sat)}$	$I_C=20\text{mA}, I_B=2\text{mA}$			0.9	V
Transition frequency	f_T	$V_{CE}=20\text{V}, I_C=10\text{mA}, f=30\text{MHz}$	50			MHz
Output Capacitance	C_{ob}	$V_{CB}=20\text{V}, I_E=0, f=1.0\text{MHz}$			3.0	pF

CLASSIFICATION OF $h_{FE(2)}$

Rank	A	B	C
Range	80-100	100-200	200-250

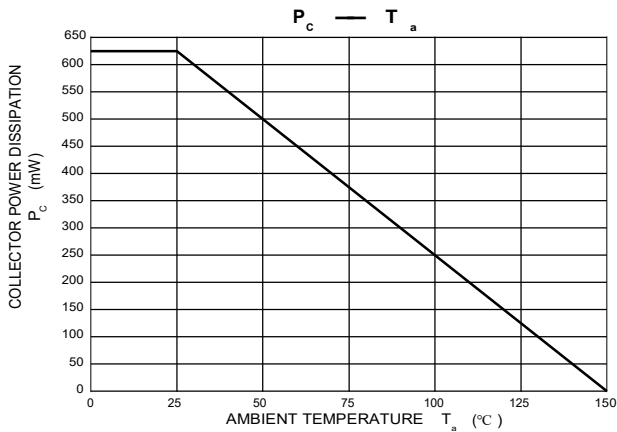
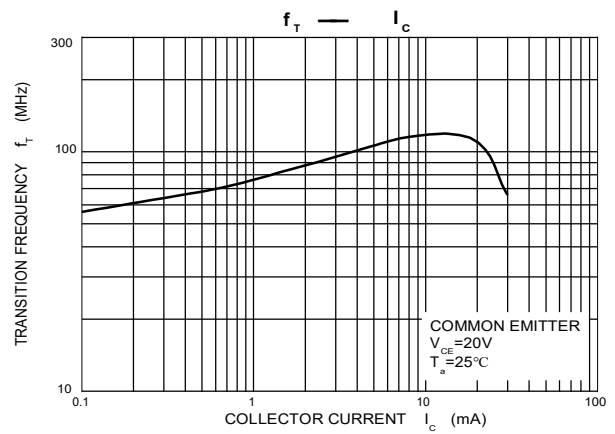
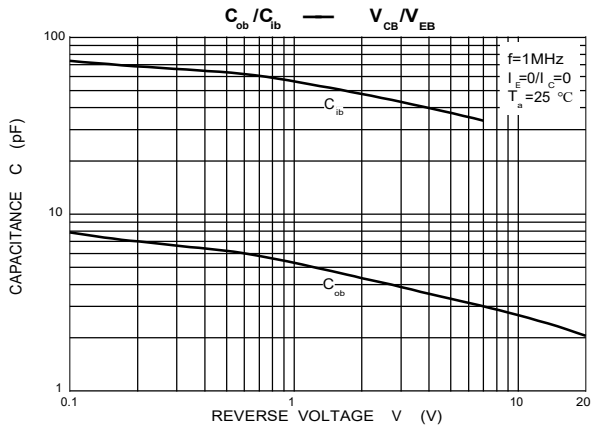
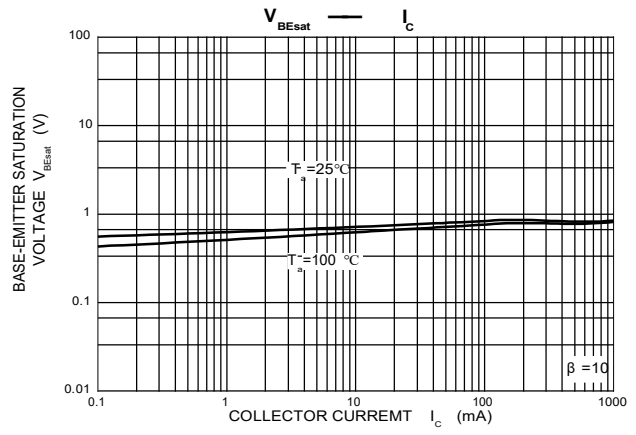
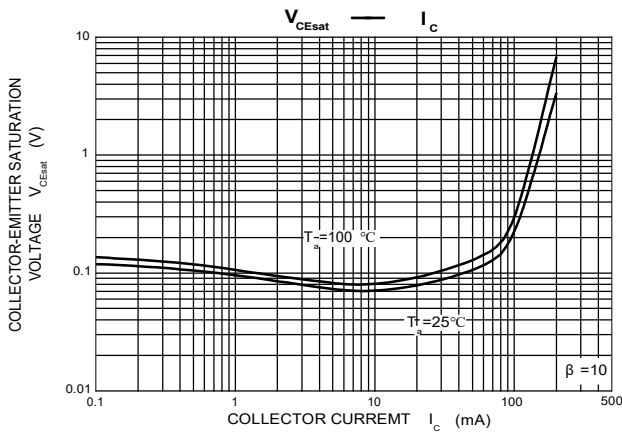
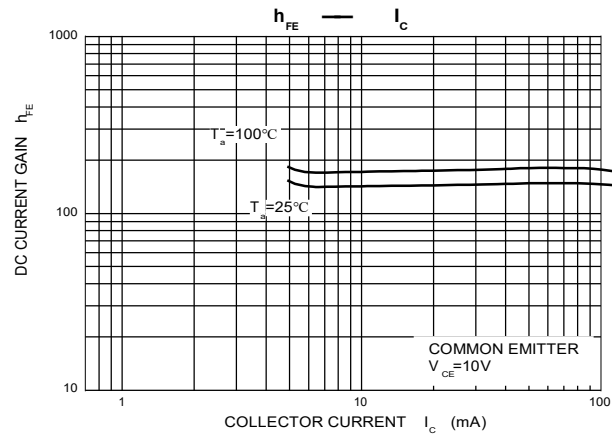
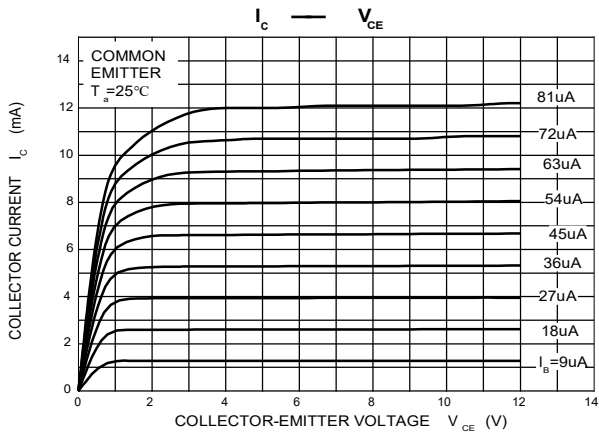

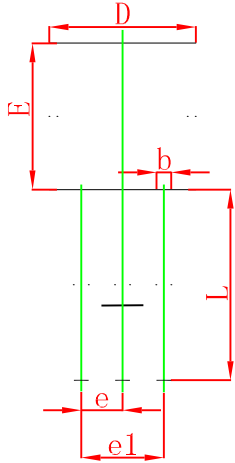
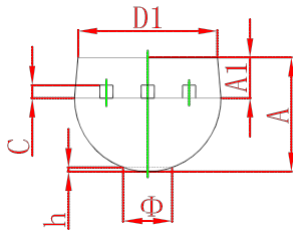

Symbol	Dimensions In Millimeters		Dimensions In Inches	
	Min	Max	Min	Max
A	3.300	3.700	0.130	0.146
A1	1.100	1.400	0.043	0.055
b	0.380	0.550	0.015	0.022
c	0.360	0.510	0.014	0.020
D	4.300	4.700	0.169	0.185
D1	3.430		0.135	
E	4.300	4.700	0.169	0.185
e	1.270 TYP		0.050 TYP	
e1	2.440	2.640	0.096	0.104
L	14.100	14.500	0.555	0.571
Φ		1.600		0.063
h	0.000	0.380	0.000	0.015

TO-92 Suggested Pad Layout

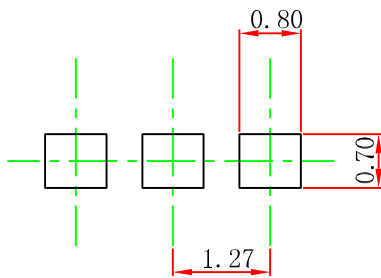

- Note:
1. Controlling dimension: In millimeters.
 2. General tolerance: ± 0.05 mm.
 3. The pad layout is for reference purposes only.

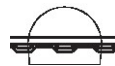
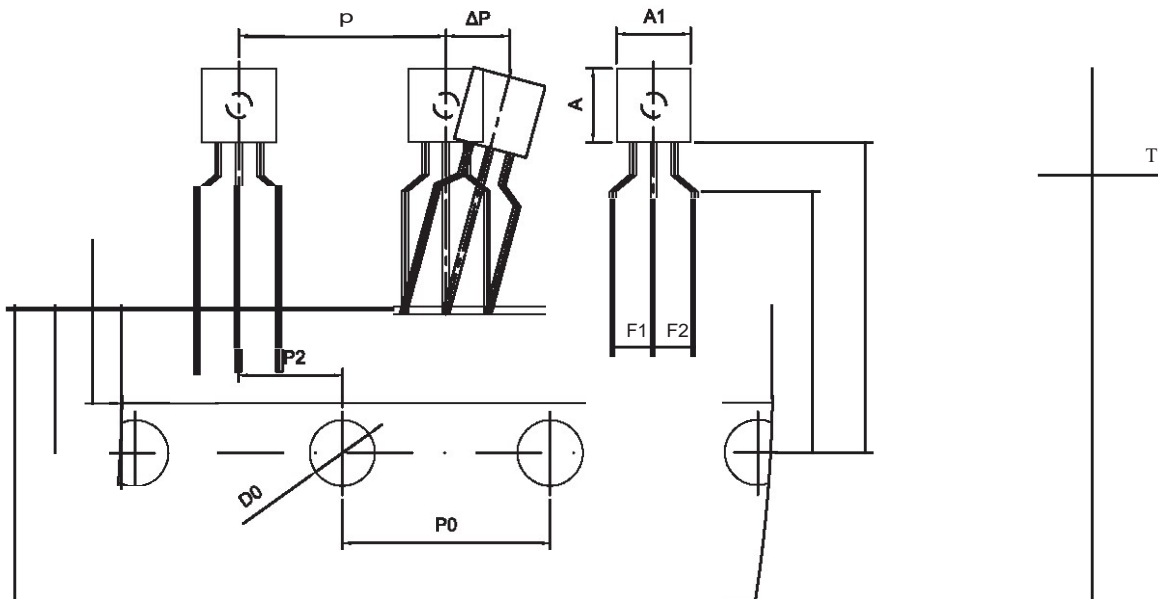
T0-92 PACKAGE TAPING DIMENSION

Dimensions are in millimeter

A1	A	T	P	P0	P2	F1	F2	W
4.5	4.5	3.5	12.7	12.7	6.35	2.5	2.5	18.0
W0	W1	W2	H	H0	D0	t1	t2	.6.P
6.0	9.0	1.0 MAX.	19.0	16.0	4.0	0.4	0.2	0

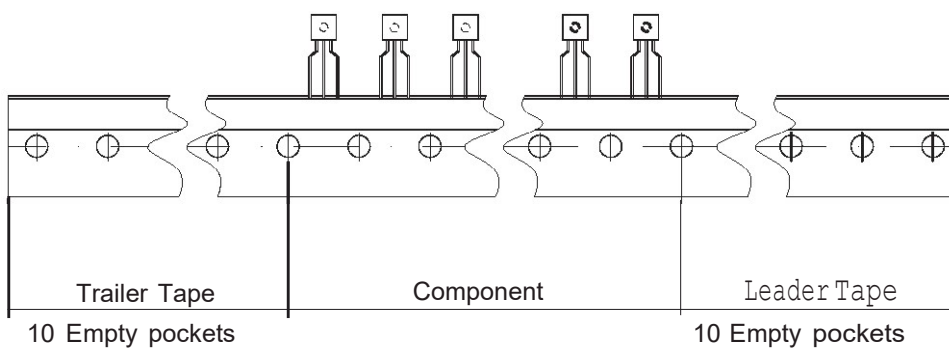

Package	Box	Box Size(mm)	Carton	Carton Size(mm)
T0-92	2000 pcs	333x162x43	20,000 pcs	350x340x250

T0-92 PACKAGE BULK

Package	Bag	Box	Box Size(mm)	Carton	Carton Size(mm)
T0-92	1000 pcs	10,000 pcs	235x170x100	50,000 pcs	485x245x180