

Inverting Octal 3-STATE Buffer

MM74HC240

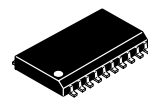

SOIC-20 WB
CASE 751D-05



TSSOP-20 WB
CASE 948E

General Description

The MM74HC240 3-STATE buffer utilizes advanced silicon-gate CMOS technology. It possesses high drive current outputs which enable high speed operation even when driving large bus capacitances. These circuits achieve speeds comparable to low power Schottky devices, while retaining the advantage of CMOS circuitry, i.e., high noise immunity and low power consumption. It has a fanout of 15 LS-TTL equivalent inputs.

The MM74HC240 is an inverting buffer and has two active LOW enables ($1\bar{G}$ and $2\bar{G}$). Each enable independently controls 4 buffers.

All inputs are protected from damage due to static discharge by diodes to V_{CC} and ground.

Features

- Typical Propagation Delay: 12 ns
- 3-STATE Outputs for Connection to System Buses
- Wide Power Supply Range: 2-6 V
- Low Quiescent Supply Current: 160 μ A (74 Series)
- Output Current: 6 mA
- These are Pb-Free Devices

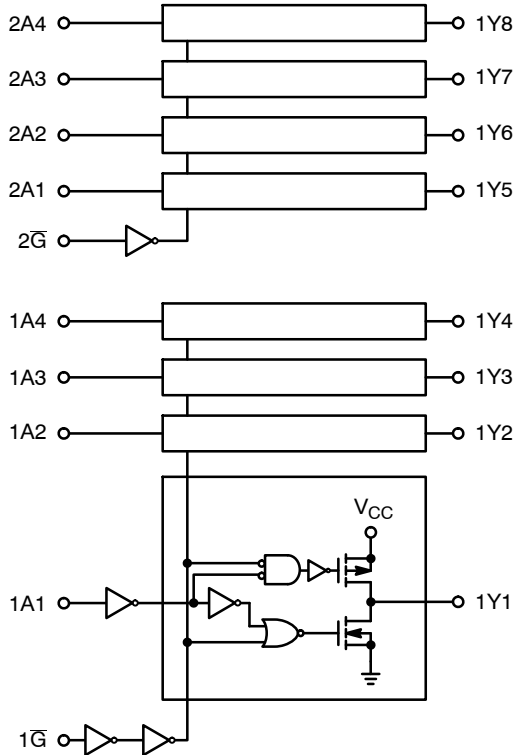
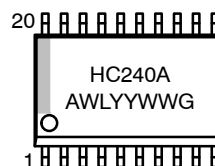
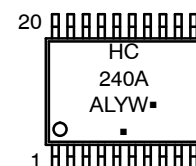

Figure 1. Logic Diagram

MARKING DIAGRAMS



(SOIC-20 WB)



(TSSOP-20 WB)

- HC240A = Specific Device Code
- A = Assembly Location
- L/WL = Wafer Lot
- Y/YY = Year
- W/WW = Work Week
- or G = Pb-Free Package

(Note: Microdot may be in either location)

CONNECTION DIAGRAM

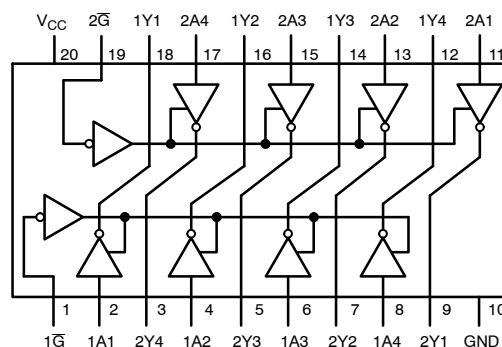

(Top View)

TRUTH TABLE

| $1\bar{G}$ | 1A | 1Y | $2\bar{G}$ | 2A | 2Y |
|------------|----|----|------------|----|----|
| L | L | H | L | L | H |
| L | H | H | L | H | H |
| H | L | Z | H | L | Z |
| H | H | Z | H | H | Z |

H = HIGH Level
L = LOW Level
Z = HIGH Impedance

ORDERING INFORMATION

See detailed ordering, marking and shipping information in the package dimensions section on page 4 of this data sheet.

MM74HC240

MAXIMUM RATINGS (Note 1)

| Symbol | Parameter | Value | Unit |
|-----------------------------------|---|-------------------------------|------|
| V _{CC} | Supply Voltage | -0.5 to +7.0 | V |
| V _{IN} | DC Input Voltage | -0.5 to V _{CC} + 0.5 | V |
| V _{OUT} | DC Output Voltage | -0.5 to V _{CC} + 0.5 | V |
| I _{IK} , I _{OK} | Clamp Diode Current | ±20 | mA |
| I _{OUT} | DC Output Current, per Pin | ±35 | mA |
| I _{CC} | DC VCC or GND Current, per Pin | ±70 | mA |
| T _{STG} | Storage Temperature Range | -65 to +150 | °C |
| P _D | Power Dissipation (Note 2) S. O. Package Only | 600 500 | mW |
| T _L | Lead Temperature (Soldering 10 seconds) | 260 | °C |

Stresses exceeding those listed in the Maximum Ratings table may damage the device. If any of these limits are exceeded, device functionality should not be assumed, damage may occur and reliability may be affected.

1. Unless otherwise specified all voltages are referenced to ground.
2. Power Dissipation temperature derating – plastic “N” package: 12 mW/°C from 65°C to 85°C.

RECOMMENDED OPERATING CONDITIONS (Note 1)

| Symbol | Parameter | Min | Max | Unit |
|------------------------------------|---|-----|--------------------|------|
| V _{CC} | Supply Voltage | 2 | 6 | V |
| V _{IN} , V _{OUT} | DC Input or Output Voltage | 0 | V _{CC} | V |
| T _A | Operating Temperature Range | -55 | +125 | °C |
| t _r , t _f | Input Rise or Fall Times V _{CC} = 2.0 V V _{CC} = 4.5 V V _{CC} = 6.0 V | - | 1000 500 400 | ns |

Functional operation above the stresses listed in the Recommended Operating Ranges is not implied. Extended exposure to stresses beyond the Recommended Operating Ranges limits may affect device reliability.

DC ELECTRICAL CHARACTERISTICS (Note 3)

| Symbol | Parameter | Conditions | V _{CC} (V) | T _A = 25°C | | -40°C ≤ T _A ≤ 85°C | | -55°C ≤ T _A ≤ 125°C | | Unit |
|-----------------|-----------------------------------|---|--|--|-------------------|-------------------------------|------|--------------------------------|-----|------|
| | | | | Typ | Guaranteed Limits | | | | | |
| V _{IH} | Minimum HIGH Level Input Voltage | | 2.0 | - | 1.5 | 1.5 | 1.5 | 1.5 | V | |
| | | | 4.5 | - | 3.15 | 3.15 | 3.15 | | | |
| | | | 6.0 | - | 4.2 | 4.2 | 4.2 | | | |
| V _{IL} | Maximum LOW Level Input Voltage | | 2.0 | - | 0.5 | 0.5 | 0.5 | V | | |
| | | | 4.5 | - | 1.35 | 1.35 | 1.35 | | | |
| | | | 6.0 | - | 1.8 | 1.8 | 1.8 | | | |
| V _{OH} | Minimum HIGH Level Output Voltage | V _{IN} = V _{IH} or V _{IL} I _{OUT} ≤ 20 μA | 2.0 | 2.0 | 1.9 | 1.9 | 1.9 | V | | |
| | | | 4.5 | 4.5 | 4.4 | 4.4 | 4.4 | | | |
| | | | 6.0 | 6.0 | 5.9 | 5.9 | 5.9 | | | |
| | | V _{IL} | V _{IN} = V _{IH} or V _{IL} I _{OUT} ≤ 6.0 mA I _{OUT} ≤ 7.8 mA | 2.0 | 4.2 | 3.98 | 3.84 | 3.7 | V | |
| | | | | 4.5 | 5.7 | 5.48 | 5.34 | 5.2 | | |
| | | | | 6.0 | | | | | | |
| V _{OL} | Maximum LOW Level Output Voltage | V _{IN} = V _{IH} or V _{IL} I _{OUT} ≤ 20 μA | 2.0 | 0 | 0.1 | 0.1 | 0.1 | V | | |
| | | | 4.5 | 0 | 0.1 | 0.1 | 0.1 | | | |
| | | | 6.0 | 0 | 0.1 | 0.1 | 0.1 | | | |
| | | I _{IN} | Maximum Input Current | V _{IN} = V _{CC} or GND | 2.0 | 0.2 | 0.26 | 0.33 | 0.4 | V |
| | | | | | 4.5 | 0.2 | 0.26 | 0.33 | 0.4 | |
| | | | | | 6.0 | | | | | |
| I _{IN} | Maximum Input Current | V _{IN} = V _{CC} or GND | 6.0 | - | ±0.1 | ±1.0 | ±1.0 | μA | | |

MM74HC240

DC ELECTRICAL CHARACTERISTICS (Note 3) (continued)

| Symbol | Parameter | Conditions | V _{CC} (V) | T _A = 25°C | | -40°C ≤ T _A ≤ 85°C | | -55°C ≤ T _A ≤ 125°C | | Unit |
|-----------------|--|--|---------------------|-----------------------|-------------------|-------------------------------|-----|--------------------------------|--|------|
| | | | | Typ | Guaranteed Limits | | | | | |
| I _{OZ} | Maximum 3-STATE Output Leakage Current | V _{IN} = V _{IH} or V _{IL} V _{OUT} = V _{CC} or GND G = V _{IH} , G = V _{IL} | 6.0 | - | ±0.5 | ±5 | ±10 | | | μA |
| I _{CC} | Maximum Quiescent Supply Current | V _{IN} = V _{CC} or GND I _{OUT} = 0 μA | 6.0 | - | 8.0 | 80 | 160 | | | μA |

3. For a power supply of 5 V ±10% the worst case output voltages (V_{OH}, and V_{OL}) occur for HC at 4.5 V. Thus the 4.5 V values should be used when designing with this supply. Worst case V_{IH} and V_{IL} occur at V_{CC} = 5.5 V and 4.5 V respectively. (The V_{IH} value at 5.5 V is 3.85 V.) The worst case leakage current (I_{IN}, I_{CC}, and I_{OZ}) occur for CMOS at the higher voltage and so the 6.0 V values should be used.

AC ELECTRICAL CHARACTERISTICS

| Symbol | Parameter | Conditions | Typ | Guaranteed Limit | Unit |
|-------------------------------------|--|---|-----|------------------|------|
| t _{PHL} , t _{PLH} | Maximum Propagation Delay | C _L = 45 pF | 12 | 18 | ns |
| t _{PZH} , t _{PZL} | Maximum Enable Delay to Active Output | R _L = 1 kΩ, C _L = 45 pF | 14 | 28 | ns |
| t _{PHZ} , t _{PLZ} | Maximum Disable Delay from Active Output | R _L = 1 kΩ, C _L = 5 pF | 13 | 25 | ns |

AC ELECTRICAL CHARACTERISTICS (V_{CC} = 2.0 V to 6.0 V, C_L = 50 pF, t_r = t_f = 6 ns (unless otherwise specified))

| Symbol | Parameter | Conditions | V _{CC} (V) | T _A = 25°C | | -40°C ≤ T _A ≤ 85°C | | -55°C ≤ T _A ≤ 125°C | | Unit |
|--|--|--|---------------------|-----------------------|-------------------|-------------------------------|-----|--------------------------------|--|------|
| | | | | Typ | Guaranteed Limits | | | | | |
| t _{PHL} , t _{PLH} | Maximum Propagation Delay | C _L = 50 pF C _L = 150 pF | 2.0 | 55 | 100 | 126 | 149 | ns | | |
| | | | 4.5 | 12 | 20 | 25 | 30 | ns | | |
| | | | 6.0 | 11 | 17 | 21 | 25 | ns | | |
| t _{PZH} , t _{PZL} | Maximum Output Enable Time | R _L = 1 kΩ C _L = 50 pF C _L = 150 pF | 2.0 | 75 | 150 | 189 | 224 | ns | | |
| | | | 4.5 | 15 | 30 | 38 | 45 | ns | | |
| | | | 6.0 | 13 | 26 | 32 | 38 | ns | | |
| t _{PHZ} , t _{PLZ} | Maximum Output Disable Time | R _L = 1 kΩ C _L = 50 pF | 2.0 | 75 | 150 | 189 | 224 | ns | | |
| | | | 4.5 | 15 | 30 | 38 | 45 | ns | | |
| | | | 6.0 | 13 | 26 | 32 | 38 | ns | | |
| t _{TLH} , t _{THL} | Maximum Output Rise and Fall Time | | 2.0 | - | 60 | 75 | 90 | ns | | |
| | | | 4.5 | - | 12 | 15 | 18 | ns | | |
| | | | 6.0 | - | 10 | 13 | 15 | ns | | |
| C _{PD} | Power Dissipation Capacitance (Note 4) | (per buffer) G = V _{IH} G = V _{IL} | - | 12 | - | - | - | pF | | |
| C _{IN} | Maximum Input Capacitance | | - | 5 | 10 | 10 | 10 | pF | | |
| C _{OUT} | Maximum Output Capacitance | | - | 10 | 20 | 20 | 20 | pF | | |

4. C_{PD} determines the no load power consumption, P_D = C_{PD} · V_{CC}² · f + I_{CC} · V_{CC}, and the no load dynamic current consumption, I_S = C_{PD} · V_{CC} · f + I_{CC}.

MM74HC240

ORDERING INFORMATION

| Device | Package | Shipping [†] |
|---------------|--------------------------|--------------------------|
| MM74HC240WM | SOIC-20 WB (Pb-Free) | 38 Units / Tube |
| MM74HC240WMX | SOIC-20 WB (Pb-Free) | 1000 Units / Tape & Reel |
| MM74HC240MTCX | TSSOP-20 WB (Pb-Free) | 2500 Units / Tape & Reel |

[†]For information on tape and reel specifications, including part orientation and tape sizes, please refer to our Tape and Reel Packaging Specifications Brochure, BRD8011/D.

MECHANICAL CASE OUTLINE PACKAGE DIMENSIONS



SCALE 1:1

SOIC-20 WB
CASE 751D-05
ISSUE H

DATE 22 APR 2015



NOTES:

1. DIMENSIONS ARE IN MILLIMETERS.
2. INTERPRET DIMENSIONS AND TOLERANCES PER ASME Y14.5M, 1994.
3. DIMENSIONS D AND E DO NOT INCLUDE MOLD PROTRUSION.
4. MAXIMUM MOLD PROTRUSION 0.15 PER SIDE.
5. DIMENSION B DOES NOT INCLUDE DAMBAR PROTRUSION. ALLOWABLE PROTRUSION SHALL BE 0.13 TOTAL IN EXCESS OF B DIMENSION AT MAXIMUM MATERIAL CONDITION.

| DIM | MILLIMETERS | |
|-----|-------------|-------|
| | MIN | MAX |
| A | 2.35 | 2.65 |
| A1 | 0.10 | 0.25 |
| b | 0.35 | 0.49 |
| c | 0.23 | 0.32 |
| D | 12.65 | 12.95 |
| E | 7.40 | 7.60 |
| e | 1.27 BSC | |
| H | 10.05 | 10.55 |
| h | 0.25 | 0.75 |
| L | 0.50 | 0.90 |
| θ | 0° | 7° |

RECOMMENDED
SOLDERING FOOTPRINT*

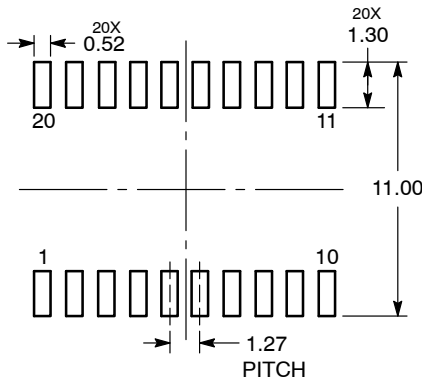

*For additional information on our Pb-Free strategy and soldering details, please download the ON Semiconductor Soldering and Mounting Techniques Reference Manual, SOLDERRM/D.

GENERIC
MARKING DIAGRAM*

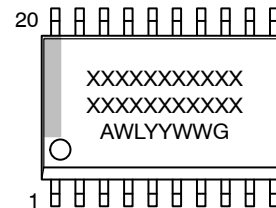

- XXXXXX = Specific Device Code
- A = Assembly Location
- WL = Wafer Lot
- YY = Year
- WW = Work Week
- G = Pb-Free Package

*This information is generic. Please refer to device data sheet for actual part marking. Pb-Free indicator, "G" or microdot "▪", may or may not be present. Some products may not follow the Generic Marking.

| | | |
|------------------|-------------|--|
| DOCUMENT NUMBER: | 98ASB42343B | Electronic versions are uncontrolled except when accessed directly from the Document Repository. Printed versions are uncontrolled except when stamped "CONTROLLED COPY" in red. |
| DESCRIPTION: | SOIC-20 WB | PAGE 1 OF 1 |

onsemi and ONSEMI are trademarks of Semiconductor Components Industries, LLC dba onsemi or its subsidiaries in the United States and/or other countries. onsemi reserves the right to make changes without further notice to any products herein. onsemi makes no warranty, representation or guarantee regarding the suitability of its products for any particular purpose, nor does onsemi assume any liability arising out of the application or use of any product or circuit, and specifically disclaims any and all liability, including without limitation special, consequential or incidental damages. onsemi does not convey any license under its patent rights nor the rights of others.

MECHANICAL CASE OUTLINE

PACKAGE DIMENSIONS

ON Semiconductor®



TSSOP-20 WB
CASE 948E
ISSUE D

DATE 17 FEB 2016

SCALE 2:1



NOTES:

1. DIMENSIONING AND TOLERANCING PER ANSI Y14.5M, 1982.
2. CONTROLLING DIMENSION: MILLIMETER.
3. DIMENSION A DOES NOT INCLUDE MOLD FLASH, PROTRUSIONS OR GATE BURRS. MOLD FLASH OR GATE BURRS SHALL NOT EXCEED 0.15 (0.006) PER SIDE.
4. DIMENSION B DOES NOT INCLUDE INTERLEAD FLASH OR PROTRUSION. INTERLEAD FLASH OR PROTRUSION SHALL NOT EXCEED 0.25 (0.010) PER SIDE.
5. DIMENSION K DOES NOT INCLUDE DAMBAR PROTRUSION. ALLOWABLE DAMBAR PROTRUSION SHALL BE 0.08 (0.003) TOTAL IN EXCESS OF THE K DIMENSION AT MAXIMUM MATERIAL CONDITION.
6. TERMINAL NUMBERS ARE SHOWN FOR REFERENCE ONLY.
7. DIMENSION A AND B ARE TO BE DETERMINED AT DATUM PLANE -W-.

| DIM | MILLIMETERS | | INCHES | |
|-----|-------------|------|-----------|-------|
| | MIN | MAX | MIN | MAX |
| A | 6.40 | 6.60 | 0.252 | 0.260 |
| B | 4.30 | 4.50 | 0.169 | 0.177 |
| C | --- | 1.20 | --- | 0.047 |
| D | 0.05 | 0.15 | 0.002 | 0.006 |
| F | 0.50 | 0.75 | 0.020 | 0.030 |
| G | 0.65 BSC | | 0.026 BSC | |
| H | 0.27 | 0.37 | 0.011 | 0.015 |
| J | 0.09 | 0.20 | 0.004 | 0.008 |
| J1 | 0.09 | 0.16 | 0.004 | 0.006 |
| K | 0.19 | 0.30 | 0.007 | 0.012 |
| K1 | 0.19 | 0.25 | 0.007 | 0.010 |
| L | 6.40 BSC | | 0.252 BSC | |
| M | 0° | 8° | 0° | 8° |



SOLDERING FOOTPRINT



DIMENSIONS: MILLIMETERS

GENERIC MARKING DIAGRAM*

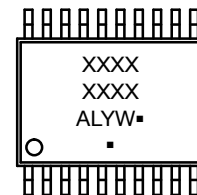

- A = Assembly Location
- L = Wafer Lot
- Y = Year
- W = Work Week
- = Pb-Free Package

(Note: Microdot may be in either location)

*This information is generic. Please refer to device data sheet for actual part marking. Pb-Free indicator, "G" or microdot "▪", may or may not be present.

| | | |
|------------------|-------------|--|
| DOCUMENT NUMBER: | 98ASH70169A | Electronic versions are uncontrolled except when accessed directly from the Document Repository. Printed versions are uncontrolled except when stamped "CONTROLLED COPY" in red. |
| DESCRIPTION: | TSSOP-20 WB | PAGE 1 OF 1 |

ON Semiconductor and ON are trademarks of Semiconductor Components Industries, LLC dba ON Semiconductor or its subsidiaries in the United States and/or other countries. ON Semiconductor reserves the right to make changes without further notice to any products herein. ON Semiconductor makes no warranty, representation or guarantee regarding the suitability of its products for any particular purpose, nor does ON Semiconductor assume any liability arising out of the application or use of any product or circuit, and specifically disclaims any and all liability, including without limitation special, consequential or incidental damages. ON Semiconductor does not convey any license under its patent rights nor the rights of others.

onsemi, **Onsemi**, and other names, marks, and brands are registered and/or common law trademarks of Semiconductor Components Industries, LLC dba "**onsemi**" or its affiliates and/or subsidiaries in the United States and/or other countries. **onsemi** owns the rights to a number of patents, trademarks, copyrights, trade secrets, and other intellectual property. A listing of **onsemi**'s product/patent coverage may be accessed at www.onsemi.com/site/pdf/Patent-Marking.pdf. **onsemi** reserves the right to make changes at any time to any products or information herein, without notice. The information herein is provided "as-is" and **onsemi** makes no warranty, representation or guarantee regarding the accuracy of the information, product features, availability, functionality, or suitability of its products for any particular purpose, nor does **onsemi** assume any liability arising out of the application or use of any product or circuit, and specifically disclaims any and all liability, including without limitation special, consequential or incidental damages. Buyer is responsible for its products and applications using **onsemi** products, including compliance with all laws, regulations and safety requirements or standards, regardless of any support or applications information provided by **onsemi**. "Typical" parameters which may be provided in **onsemi** data sheets and/or specifications can and do vary in different applications and actual performance may vary over time. All operating parameters, including "Typicals" must be validated for each customer application by customer's technical experts. **onsemi** does not convey any license under any of its intellectual property rights nor the rights of others. **onsemi** products are not designed, intended, or authorized for use as a critical component in life support systems or any FDA Class 3 medical devices or medical devices with a same or similar classification in a foreign jurisdiction or any devices intended for implantation in the human body. Should Buyer purchase or use **onsemi** products for any such unintended or unauthorized application, Buyer shall indemnify and hold **onsemi** and its officers, employees, subsidiaries, affiliates, and distributors harmless against all claims, costs, damages, and expenses, and reasonable attorney fees arising out of, directly or indirectly, any claim of personal injury or death associated with such unintended or unauthorized use, even if such claim alleges that **onsemi** was negligent regarding the design or manufacture of the part. **onsemi** is an Equal Opportunity/Affirmative Action Employer. This literature is subject to all applicable copyright laws and is not for resale in any manner.

PUBLICATION ORDERING INFORMATION

LITERATURE FULFILLMENT:

Email Requests to: orderlit@onsemi.com

onsemi Website: www.onsemi.com

TECHNICAL SUPPORT

North American Technical Support:

Voice Mail: 1 800-282-9855 Toll Free USA/Canada

Phone: 011 421 33 790 2910

Europe, Middle East and Africa Technical Support:

Phone: 00421 33 790 2910

For additional information, please contact your local Sales Representative