

mikromedia ⁴
for TIVA CAPACITIVE

MIKROE

SCHEMATIC

POWER SUPPLY

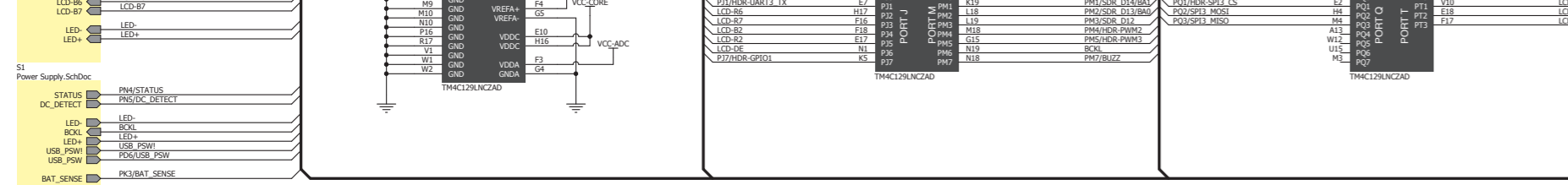
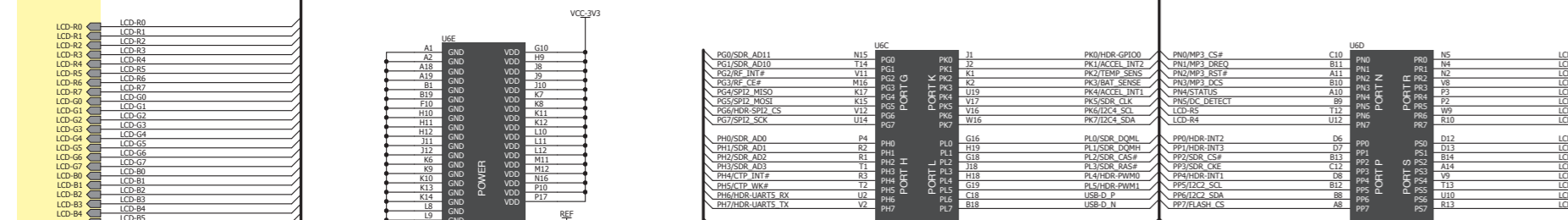
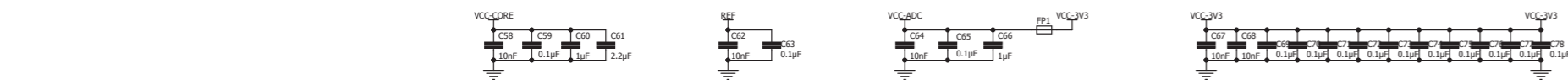

Voltage reference

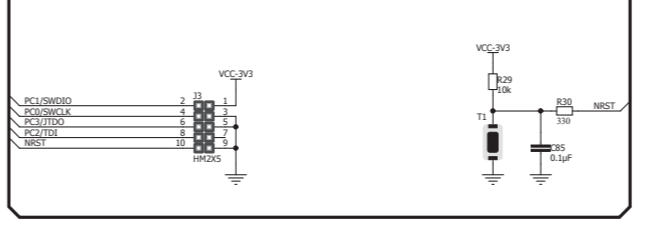
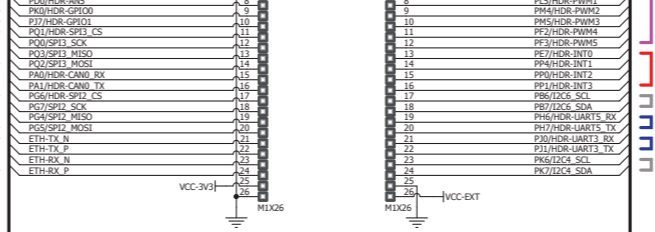
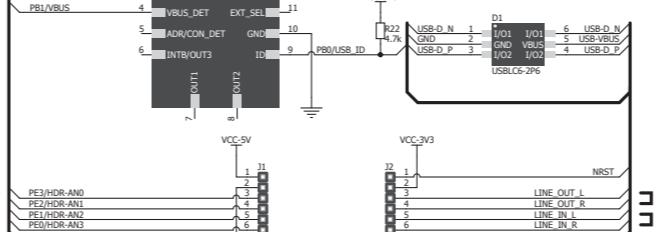
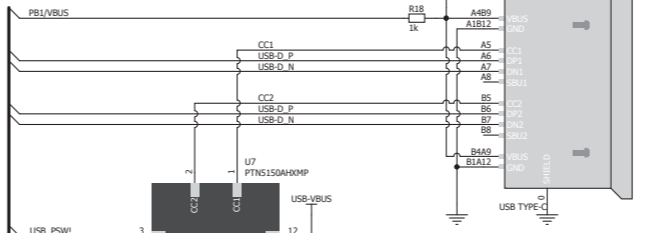
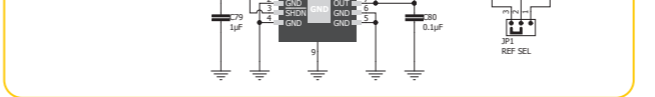

SDRAM

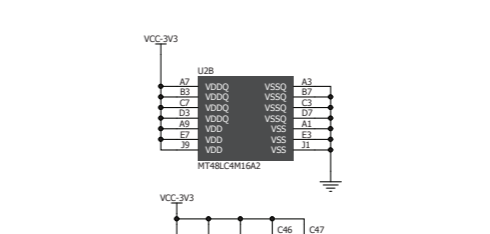
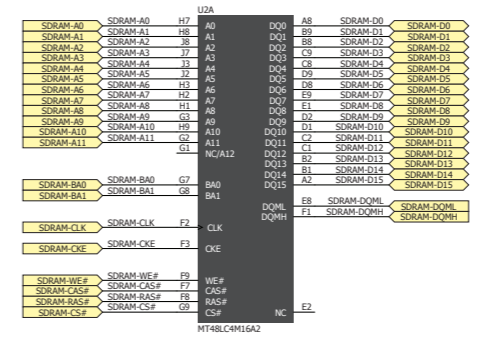

Flash memory

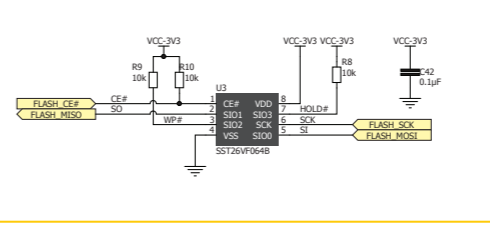

RF

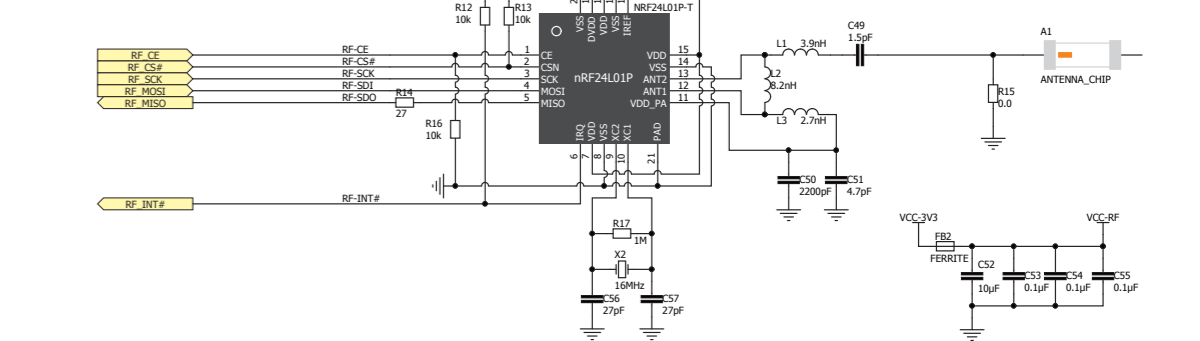

SD card

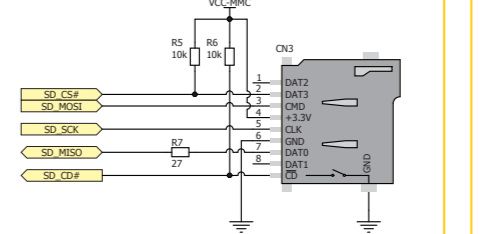

TFT

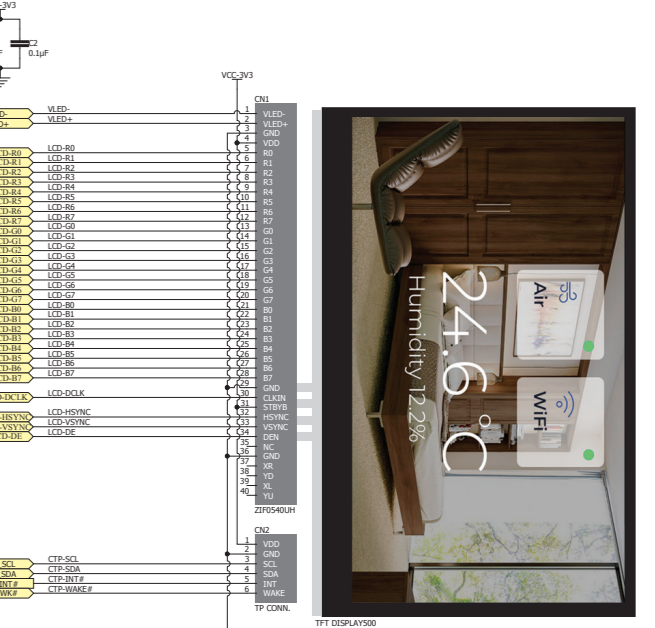

MikroElektronika assumes no responsibility or liability for any errors or inaccuracies that may appear in the present document. Specification and information contained in this schematic are subject to change at any time without notice. Copyright©2020 MikroElektronika. All rights reserved.