

IGBT Modules

V_{CES} 1200V
I_C 75A



Applications

- Industrial Inverters
- Servo Applications
- SMPS UPS
- Induction Heating
- Welder

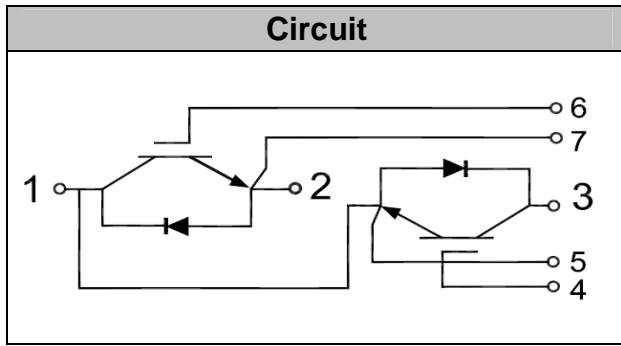

Features

- Short Circuit Rated 10 μ s
- Low Stray Inductance
- Low Saturation Voltage
- Ultra Low loss
- HI-REL Power Terminals
- Lead Free, Compliant With RoHS Requirement

Absolute Maximum Ratings (T_C = 25°C unless otherwise specified)

Symbol	Description	Values	Units	
V _{CES}	Collector - Emitter Voltage	1200	V	
V _{GES}	Gate-Emitter Voltage	±20	V	
I _C	DC Collector Current	T _C =25°C	105	A
		T _C =80°C	75	A
I _{CM(1)}	Peak Collector Current Repetitive	T _J = 125°C	150	A
I _F	Diode Continuous Forward Current	T _J = 125°C	75	A
I _{FM}	Peak FWD Current Repetitive		150	A
t _{SC}	Short Circuit Withstand Time		>10	μ s
P _D	Maximum Power Dissipation (IGBT)	T _C = 25°C, T _{Jmax} =150°C	625	W
T _J	Maximum Junction Temperature		150	°C
T _{JOP}	Operating Temperature		-40 ~ +150	°C
T _{stg}	Storage Temperature		-40 ~ +125	°C
Viso	Isolation Voltage (All Terminals Shorted)	f=50Hz, 1min	3000	V
Mounting Torque	Power Terminals Screw:M5		3~5	N*m
	Mounting Screw:M6		4~6	N*m

Notes :

(1) Repetitive Rating: Pulse width limited by max. junction temperature



Electrical Characteristics of IGBT ($T_J = 25^\circ\text{C}$ unless otherwise specified)

Symbol	Item	Conditions	Values			Units
			Min.	Typ.	Max.	
OFF Characteristics						
$V_{(BR)CES}$	Collector-Emitter Breakdown Voltage	$V_{GE} = 0V, I_C = 1mA$	1200			V
I_{CES}	Collector Leakage Current	$V_{CE}=V_{CES}, V_{GE}=0V,$			100	μA
		$V_{CE}=V_{CES}, V_{GE}=0V,$ $T_J=125^\circ\text{C}$			1	mA
I_{GES}	Gate Leakage Current	$V_{CE}=0V, V_{GE}=\pm 20V$	-400		400	nA
ON Characteristics						
$V_{GE(th)}$	Gate - Emitter Threshold Voltage	$V_{CE}=V_{GE}, I_C=3mA$	5	6.2	7	V
$V_{CE(sat)}$	Collector – Emitter Saturation Voltage	$I_C=75A, V_{GE}=15V$		1.8		V
		$I_C=75A, V_{GE}=15V,$ $T_J=125^\circ\text{C}$		2		V
Dynamic Characteristics						
C_{ies}	Input Capacitance	$V_{CE} = 25V, V_{GE} = 0V,$ $f = 1MHz$		5.5		nF
C_{oes}	Output Capacitance			0.4		nF
Switching Characteristics						
$t_{d(on)}$	Turn-on Delay Time	$V_{CC} = 600V, I_C = 75A,$ $R_G = 15\Omega, V_{GE} = \pm 15V,$ Inductive Load, $T_J = 25^\circ\text{C}$		80		ns
t_r	Rise Time			70		ns
$t_{d(off)}$	Turn-off Delay Time			248		ns
T_f	Fall Time			290		ns
E_{on}	Turn-on Switching Loss			7.45		mJ
E_{off}	Turn-off Switching Loss			4.9		mJ
$t_{d(on)}$	Turn-on Delay Time	$V_{CC} = 600V, I_C = 75A,$ $R_G = 15\Omega, V_{GE} = \pm 15V,$ Inductive Load, $T_J = 125^\circ\text{C}$		95		ns
t_r	Rise Time			85		ns
$t_{d(off)}$	Turn-off Delay Time			262		ns
T_f	Fall Time			320		ns
E_{on}	Turn-on Switching Loss			10.3		mJ
E_{off}	Turn-off Switching Loss			7.8		mJ
Q_{ge}	Gate Charge	$V_{CC}=600V, I_C=75A,$ $V_{GE}=\pm 15V$		780		nC
RBSOA	Reverse Bias Safe Operating Area	$I_C = 150A, V_{CC} = 600V,$ $V_p = 1200V, R_g = 15\Omega,$ $V_{GE} = +15V \text{ to } 0V,$ $T_J = 150^\circ\text{C}$	Trapezoid			
SCSOA	Short Circuit Safe Operating Area	$V_{CC} = 600V, V_{GE} = 15V,$ $T_J = 150^\circ\text{C}$	10			μs



Electrical Characteristics of FWD ($T_C = 25^\circ\text{C}$ unless otherwise specified)

Symbol	Item	Conditions	Values			Units
			Min.	Typ.	Max.	
V_{FM}	Forward Voltage	$I_F = 75\text{A}, V_{GE} = 0\text{V}$	$T_J = 25^\circ\text{C}$	2	2.4	V
			$T_J = 125^\circ\text{C}$	1.7	2.2	
t_{rr}	Reverse Recovery Time	$I_F = 75\text{A},$ $di/dt = 1400\text{A}/\mu\text{s},$ $V_{rr} = 600\text{V},$ $V_{GE} = -15\text{V}$	$T_J = 25^\circ\text{C}$	160		ns
			$T_J = 125^\circ\text{C}$	200		
I_{rr}	Peak Reverse Recovery Current		$T_J = 25^\circ\text{C}$	55		A
			$T_J = 125^\circ\text{C}$	70		
Q_{rr}	Reverse Recovery Charge		$T_J = 25^\circ\text{C}$	5.3		μC
			$T_J = 125^\circ\text{C}$	8.2		

Thermal Resistance Characteristics

Symbol	Description	Values			Units
		Min.	Typ.	Max.	
$R_{\theta JC}$	Junction-To-Case (IGBT Part, Per Leg)			0.2	$^\circ\text{C}/\text{W}$
$R_{\theta JC}$	Junction-To-Case (Diode Part, Per Leg)			0.5	$^\circ\text{C}/\text{W}$
$R_{\theta CS}$	Case-To-Sink (Conductive Grease Applied)			0.1	$^\circ\text{C}/\text{W}$
Mt	Power Terminals Screw:M5		3	3.15	N·m
Ms	Mounting Screw:M6		5	5.75	N·m
Weight	Weight Of Module		150	160	g

Performance Curves

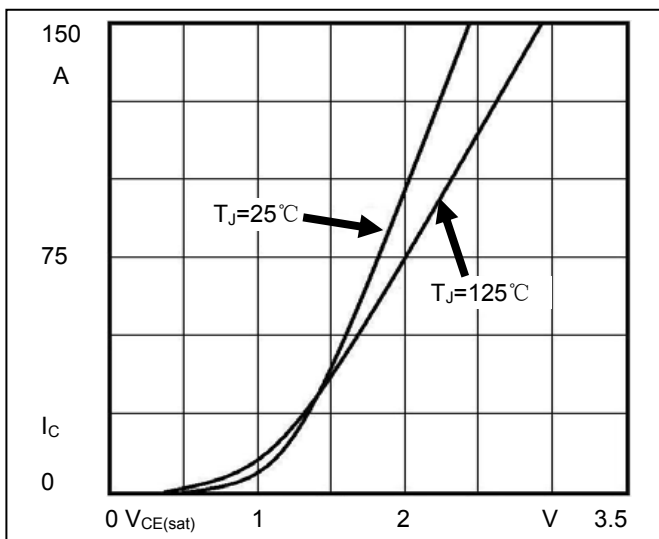

Fig1. Typical Output Characteristics

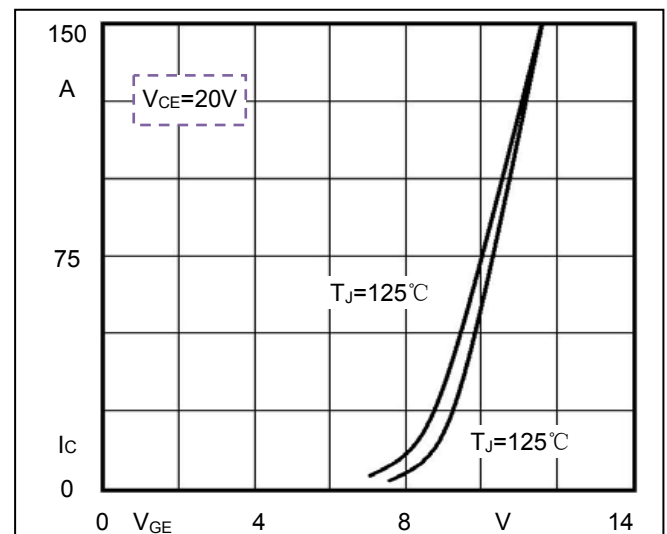

Fig2. Typical Transfer Characteristics

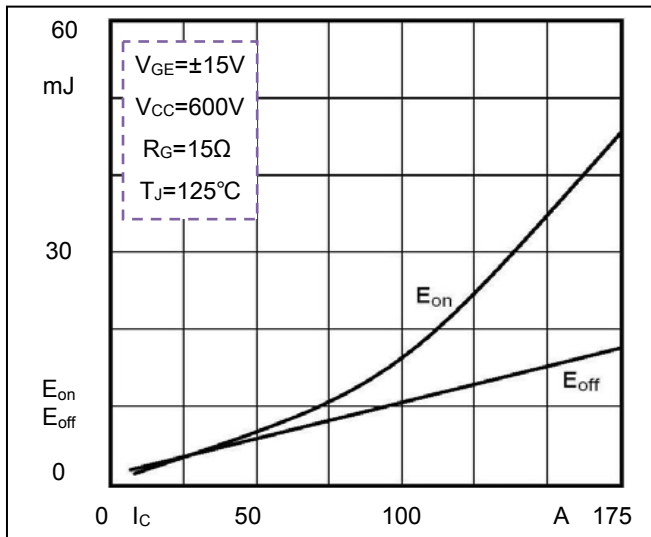

Fig3. Switching Energy vs. Collector Current

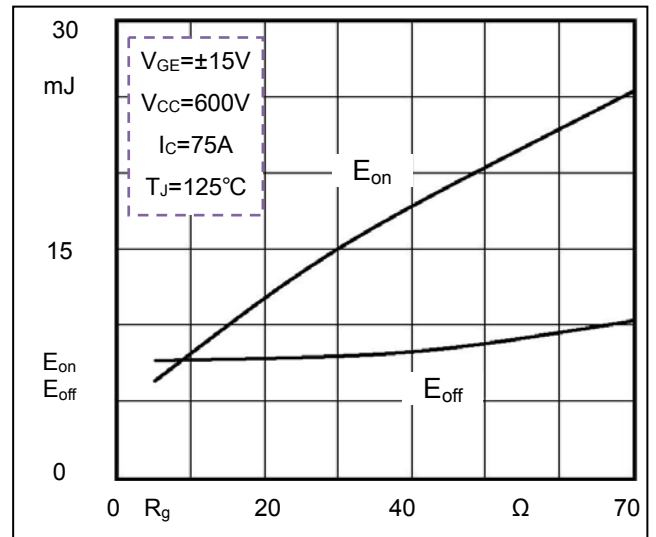

Fig4. Switching Energy vs. Gate Resistor

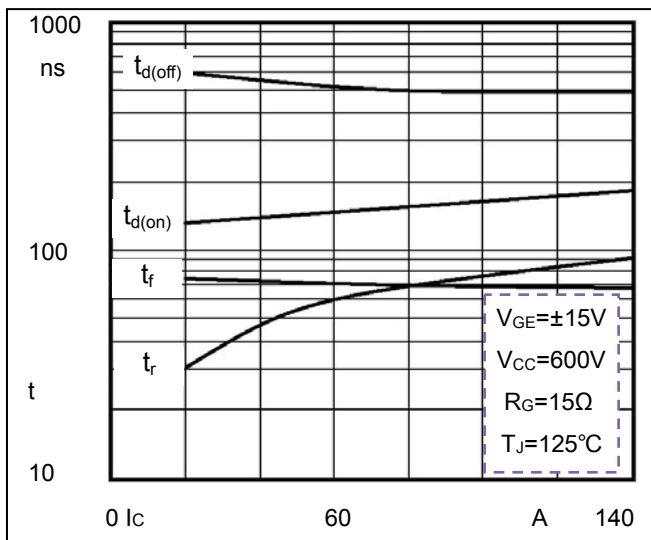

Fig5. Switching Times vs. Collector Current

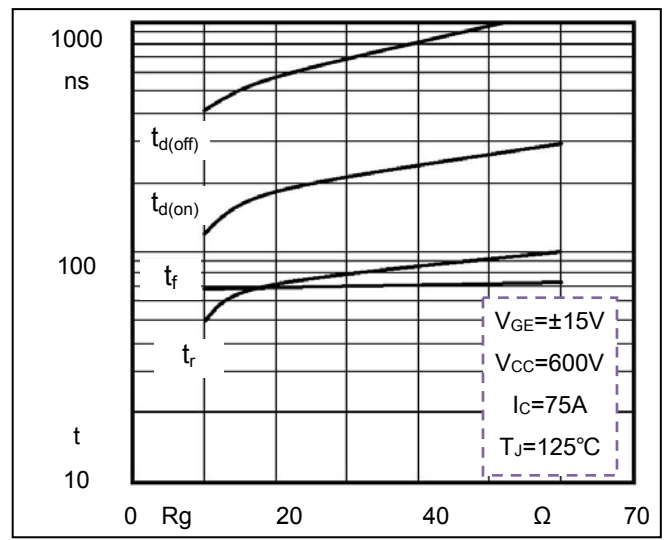

Fig6. Switching Times vs. Gate Resistor

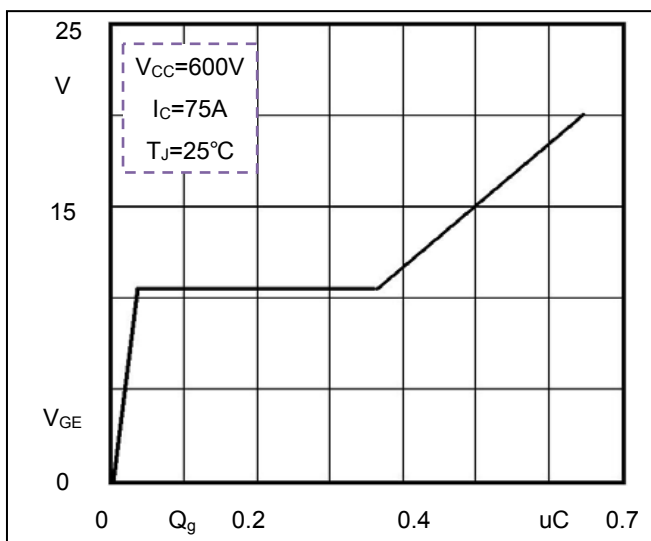

Fig7. Gate Charge characteristics

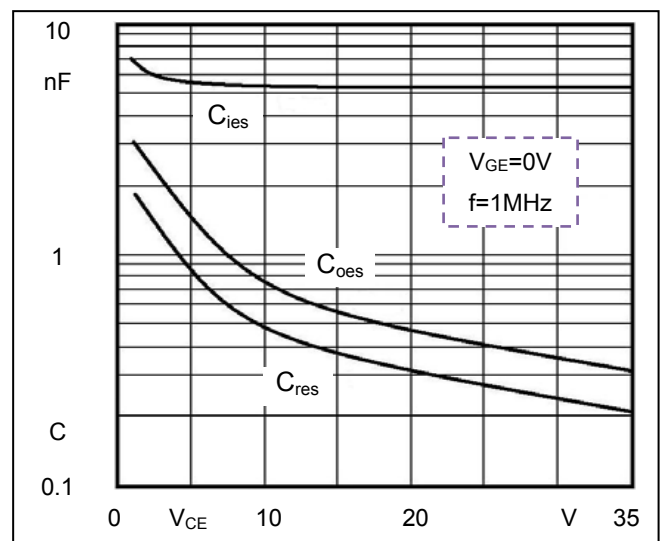

Fig8. Typical Capacitances vs. V_{CE}

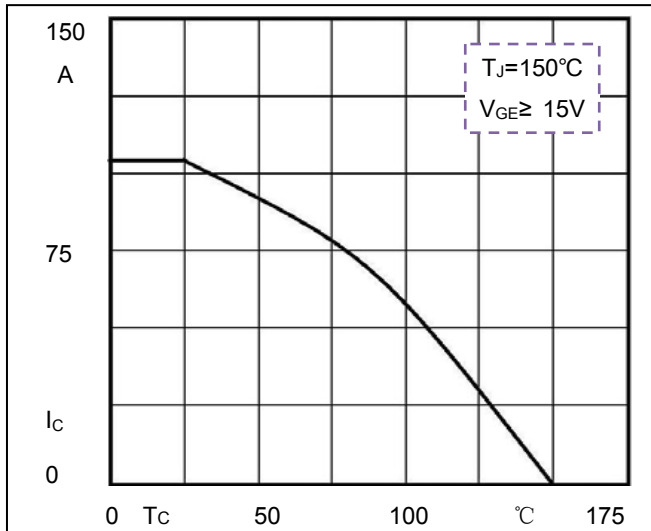

Fig9. Rated Current vs. T_c

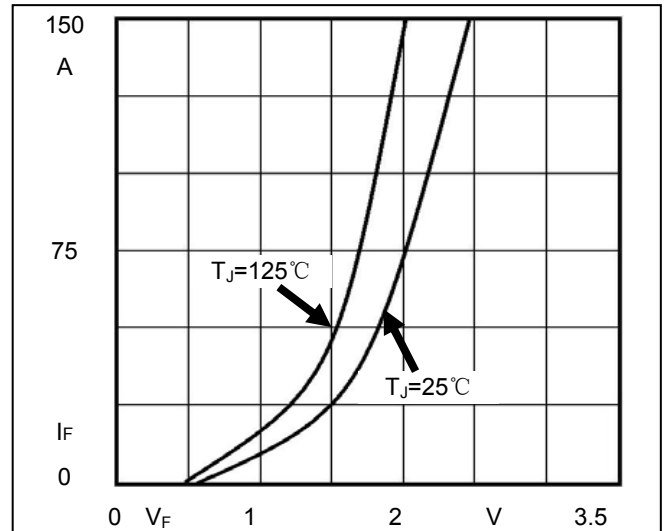

Fig10. Diode Forward Characteristics

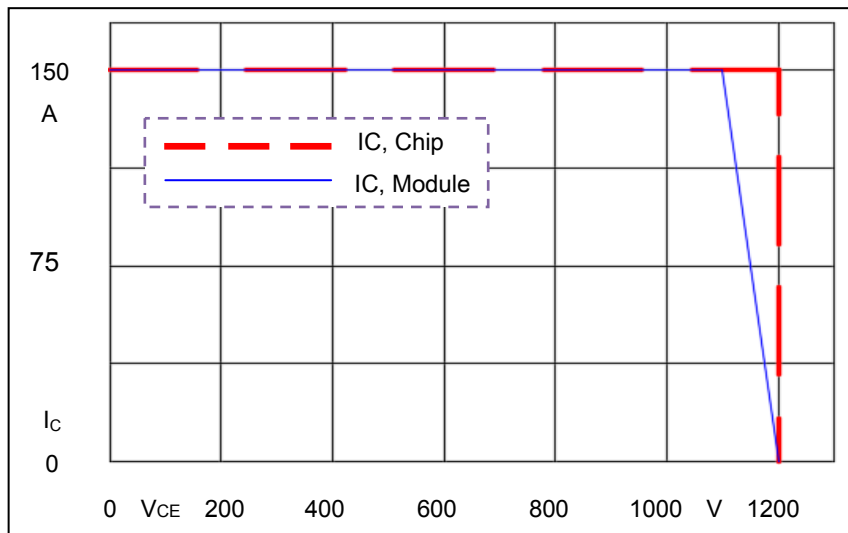

Fig11. Reverse Bias Safe Operation Area (RBSOA)

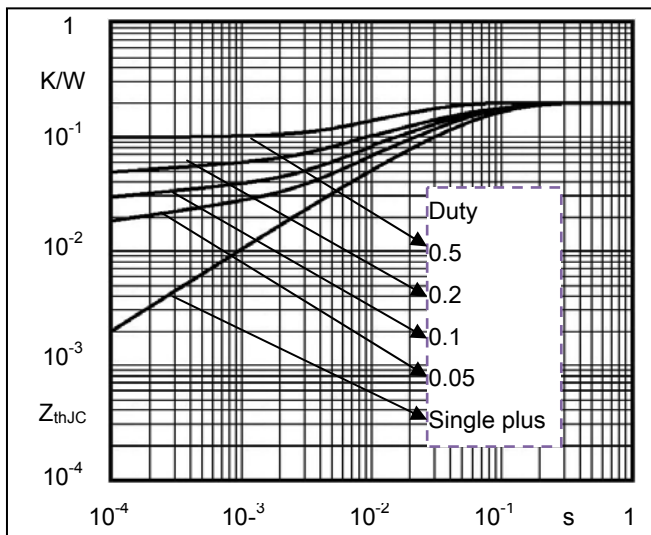

Fig12. Transient Thermal Impedance of IGBT

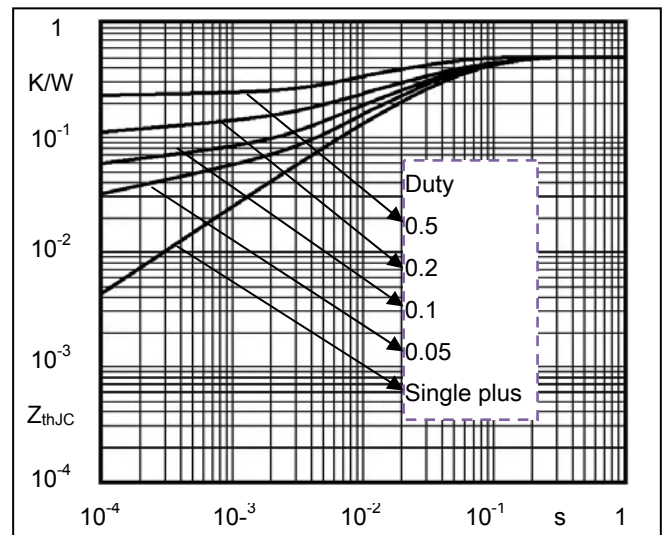
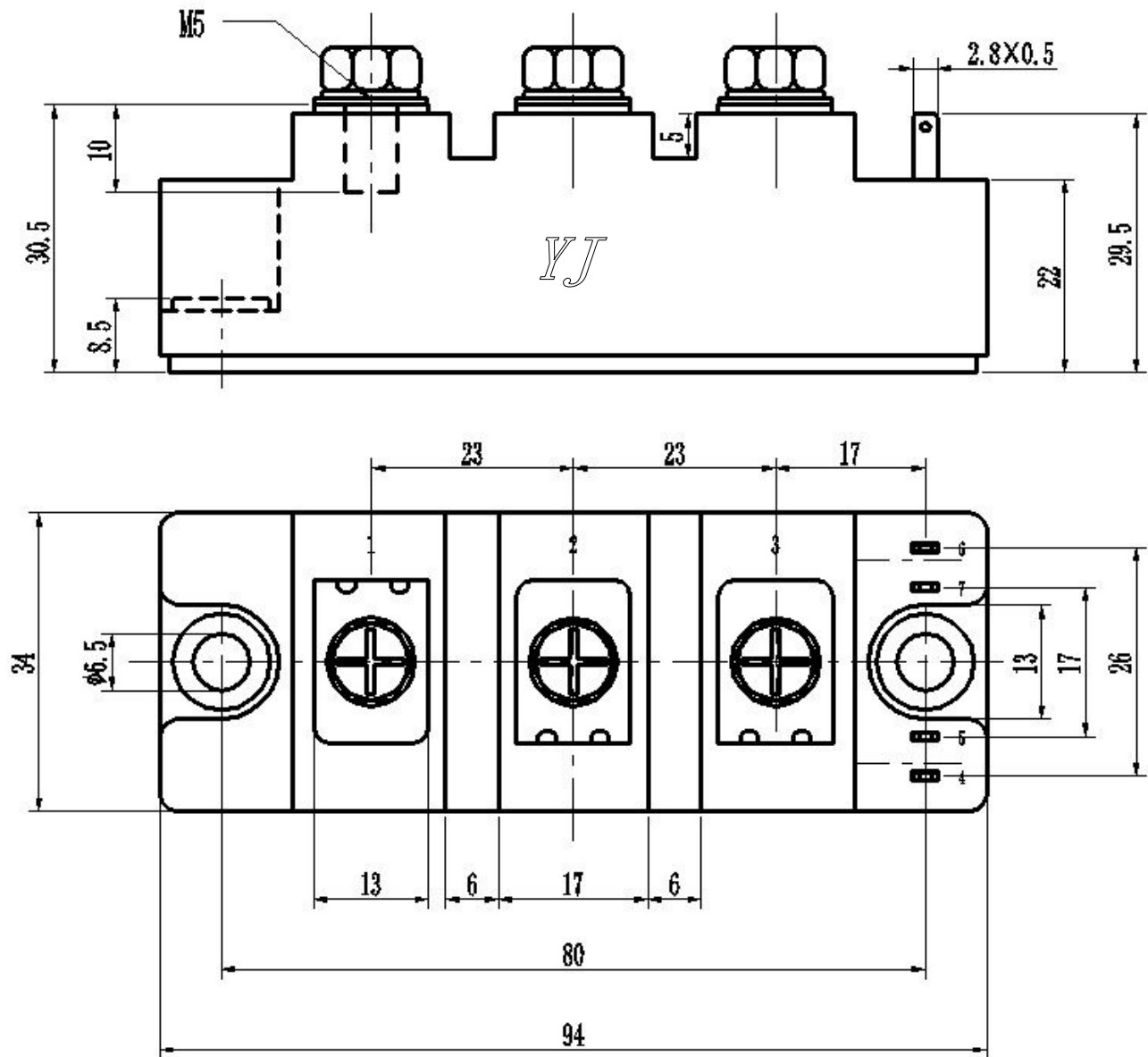

Fig13. Transient Thermal Impedance of Diode

Package Outline Information

CASE: C1



Dimensions in mm