

BN 781 - DIN 6798 A

Serrated lock washers
type A, external serrated

DIN 6798 A
~UNI 8842 A

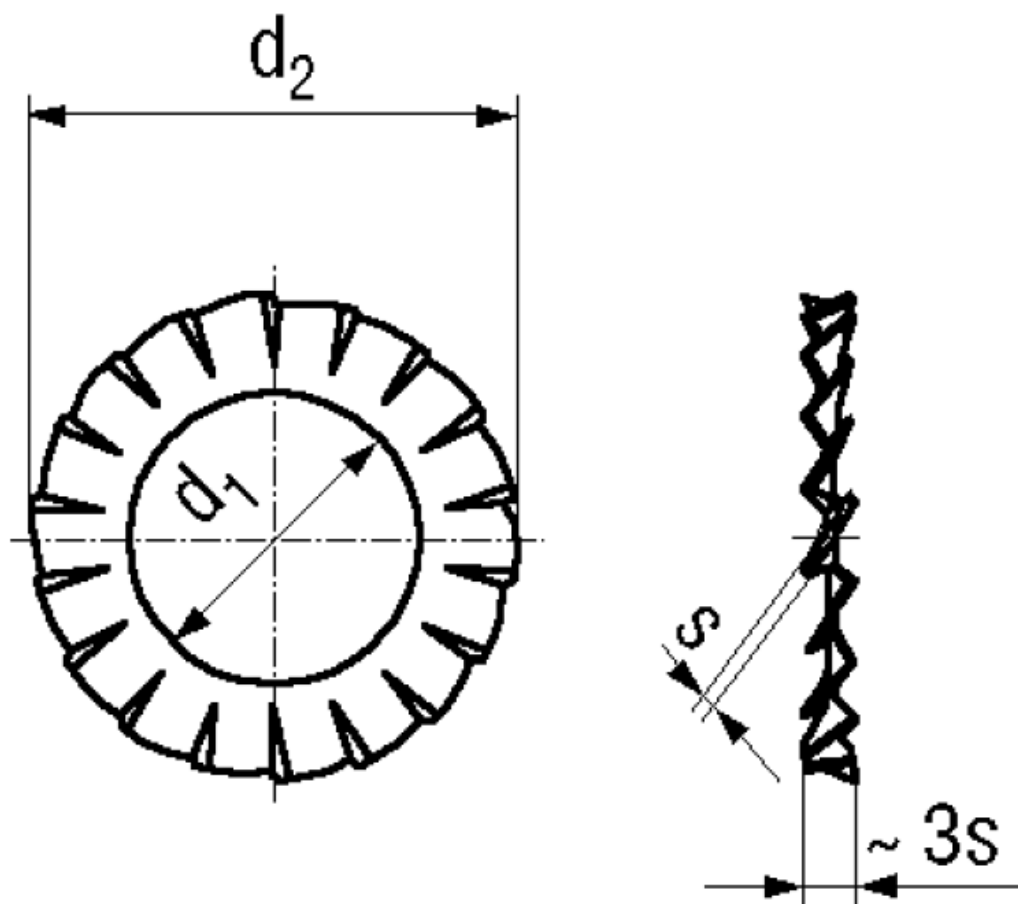

Material	Spring steel	Hardness	350-425 HV
Surface	zinc plated blue		

Article No. - 1278053	
for thread	M4
d ₁ min.	4,3
d ₂ max.	8
s	0,5

Standard withdrawn.

M5 x 5,1 ; M8 x 8,2: for hex cap screws.

Spring elements ≥ 320 HV electroplated coatings: Susceptible to hydrogen embrittlement!
Other coatings on request.