



LGE3M40065Q

Silicon Carbide Power MOSFET



Features

- High voltage, low on resistance
- High speed, low parasitic capacitance
- High junction temperature
- Fast recovery diode
- Kelvin connection driver

$V_{DS} = 650\text{ V}$
 $I_D@25^\circ\text{C} = 72\text{ A}$
 $R_{DS(ON)} = 40\text{ m}\Omega$

Benefits

- Higher System Efficiency
- Parallel Device Convenience without thermal runaway
- High Temperature Application
- Hard Switching & Higher Reliability
- Easy to drive

Applications

- Electric vehicle charging device
- Server and communication power
- Photovoltaic inverter
- UPS power supply
- High voltage DC / DC converter
- Switching Mode Power Suppl

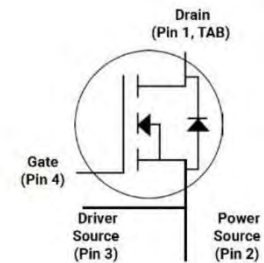

TO-247-4L
Pin definition

Key performance parameters

Type	V_{DS}	I_D $T_C=25^\circ\text{C}$	$R_{DS(ON)}$
LGE3M40065Q	650V	72A	40m Ω

Caution: This device is sensitive to electrostatic discharge .Users should follow ESD handling procedures.



LGE3M40065Q

Silicon Carbide Power MOSFET



Maximum Ratings

$T_C=25^{\circ}\text{C}$, unless otherwise specified

Parameter	Symbol	Value	Unit
Drain-source voltage $V_{GS} = 0\text{V}$, $I_D = 100 \mu\text{A}$	V_{DS}	650	V
Gate-source voltage Recommended maximum	V_{GS}	-5 to 20	V

Maximum Ratings

$T_C=25^{\circ}\text{C}$, unless otherwise specified

Parameter	Symbol	Value	Unit
Continuous drain current : $V_{GS} = 20\text{V}$ $T_C = 25^{\circ}\text{C}$ $T_C = 100^{\circ}\text{C}$	I_D	72 58	A
Pulsed drain current: Pulse width limited by SOA	I_{DM}	180	A
Power dissipation : $T_C = 25^{\circ}\text{C}$	P_{TOT}	348	W
Storage temperature range :	T_{stg}	-55 to +175	$^{\circ}\text{C}$
Operating and junction temperature:	T_j	-55 to +175	$^{\circ}\text{C}$
Soldre temperature: Wave soldering only allowed at leads, 1.6 mm from case for 10 s	T_L	260	$^{\circ}\text{C}$

Thermal Resistance

Parameter	Symbol	Typ.	Unit
Thermal resistance to shell	R_{thJC}	0.431	$^{\circ}\text{C}/\text{W}$



LGE3M40065Q

Silicon Carbide Power MOSFET



Electrical Characteristic

$T_C = 25^\circ\text{C}$, unless otherwise specified

Parameter	Symbol	Value			Unit	Test Condition
		Min.	Typ.	Max.		
Zero gate voltage drain current	I_{DSS}		3	100	μA	$V_{DS} = 650\text{V}$ $V_{GS} = 0\text{V}$
Gate leakage current	I_{GSS}		1	± 100	nA	$V_{DS} = 0\text{V}$ $V_{GS} = -5\sim 20\text{V}$
Gate threshold voltage	V_{TH}		3.2 2.2		V	$V_{GS} = V_{DS}$ $I_D = 6.1\text{mA}$ $T_C = 175^\circ\text{C}$
Drain-source on-state resistance	R_{ON}		40 53	55	$\text{m}\Omega$	$V_{GS} = 20\text{V}$ $I_D = 20\text{A}$ $T_J = 25^\circ\text{C}$ $T_J = 175^\circ\text{C}$
Input capacitance	C_{iss}		2692		pF	$V_{DS} = 600\text{V}$ $V_{GS} = 0\text{V}$ $f = 1\text{MHz}$ $V_{AC} = 25\text{mV}$
Output capacitance	C_{oss}		179			
Reverse transfer capacitance	C_{rss}		10.8			
The output capacitor stores energy	E_{oss}		35.6		μJ	
Total gate charge	Q_g		110.8		nC	$V_{DS} = 400\text{V}$ $I_D = 20\text{A}$ $V_{GS} = -5\text{ to }20\text{V}$
Gate to source charge	Q_{gs}		26.8			
Gate to drain charge	Q_{gd}		35.7			
Gate input resistance	R_g		2		Ω	$f = 1\text{MHz}$
Turn-on switching energy	E_{ON}		163.1		μJ	$V_{DS} = 400\text{V}$, $I_D = 30\text{A}$, $V_{GS} = -2\text{ to }20\text{V}$, $R_{G(ext)} = 3.3\Omega$, $L = 450\mu\text{H}$
Turn-off switching energy	E_{OFF}		53.0		μJ	
Turn-on delay time	$t_{d(on)}$		12.2		ns	
Rise time	t_r		17.6			

Caution: This device is sensitive to electrostatic discharge .Users should follow ESD handing procedures.



LGE3M40065Q

Silicon Carbide Power MOSFET



Turn-off delay time	$t_{d(off)}$		30.2		
Fall time	t_f		12.6		

Reverse Diode Characteristics

$T_C = 25^\circ\text{C}$, unless otherwise specified

Parameter	Symbol	Value			Unit	Test Condition
		Min.	Typ.	Max.		
Diode forward voltage	V_{SD}		4.0 3.6		V	$I_{SD} = 20\text{A}$ $V_{GS} = 0\text{V}$ $T_J = 175^\circ\text{C}$
Reverse recovery time	t_{rr}		15.6		ns	$V_{GS} = -2\text{V}/+20\text{V}$, $I_{SD} = 30\text{A}$, $V_R = 400\text{V}$, $di/dt = 1884\text{A}/\mu\text{s}$, $R_{G(ext)} = 15\ \Omega$ $L = 450\ \mu\text{H}$
Reverse recovery charge	Q_{rr}		130.3		nC	
Reverse recovery peak current	I_{RRM}		13.4		A	

Caution: This device is sensitive to electrostatic discharge .Users should follow ESD handing procedures



图. 1 输出曲线 @ $T_j = -55^\circ\text{C}$



图. 2 输出曲线 @ $T_j = 25^\circ\text{C}$

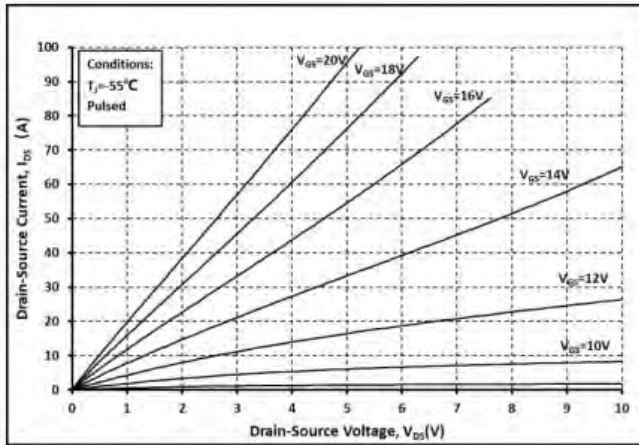

图. 3 输出曲线 @ $T_j = 175^\circ\text{C}$

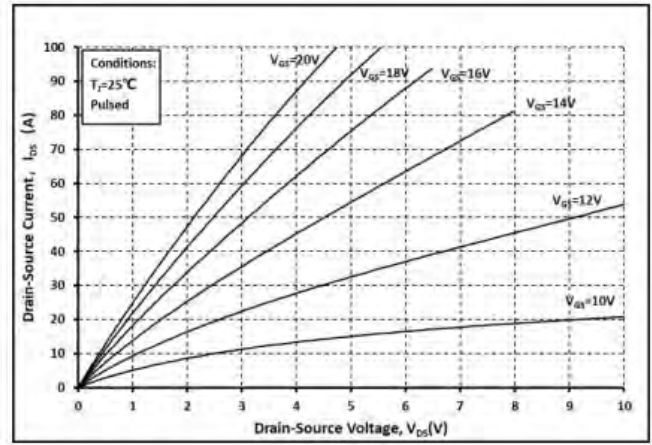

图. 4 R_{on} 和温度关系曲线

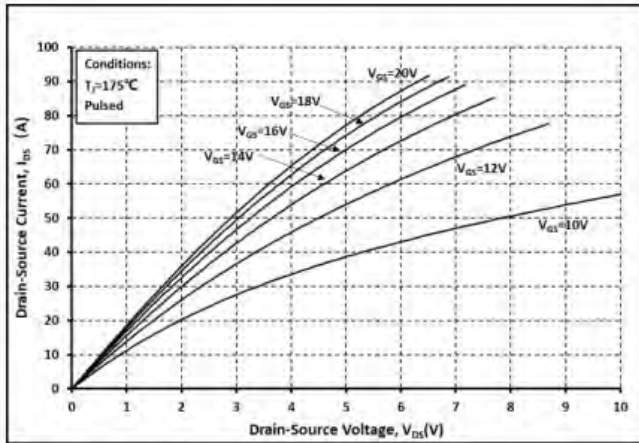

图. 5 归一化的 R_{on} 和温度关系曲线

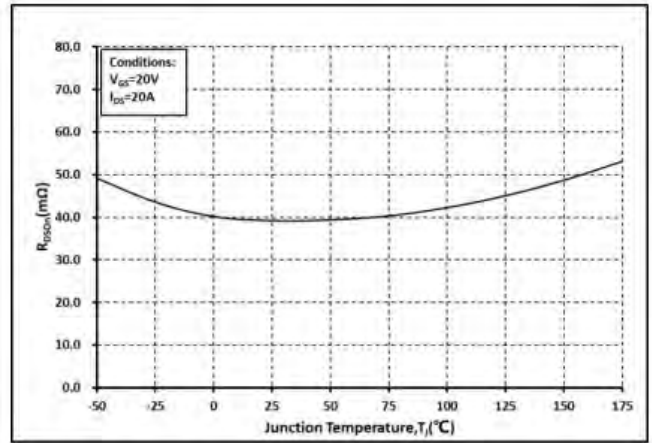

图. 6 各温度下的 R_{on} 和 I_{DS} 关系曲线

Caution: This device is sensitive to electrostatic discharge .Users should follow ESD handling procedure

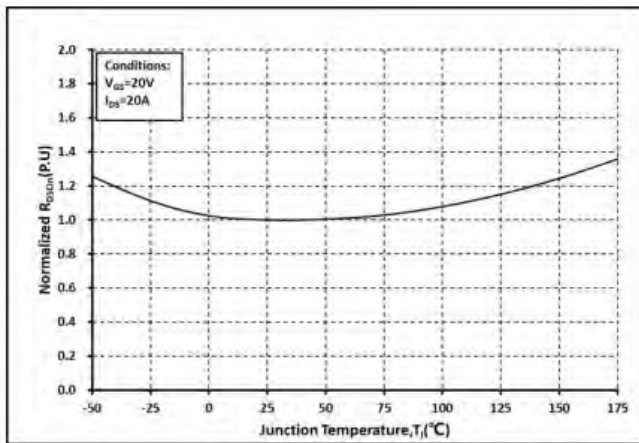

图. 7 各 V_{GS} 下的 R_{on} 和温度关系曲线

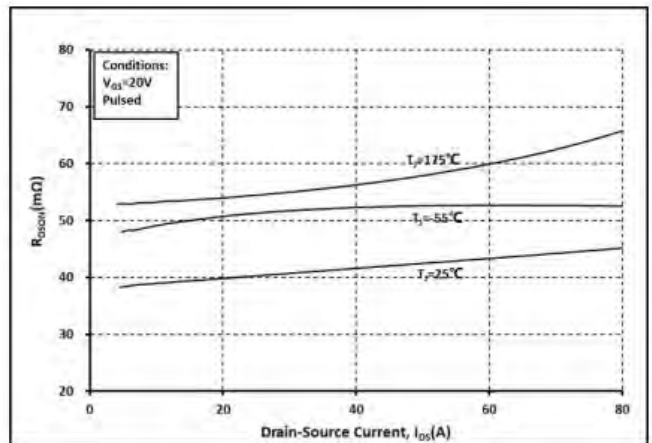

图. 8 各温度下的传输特性曲线

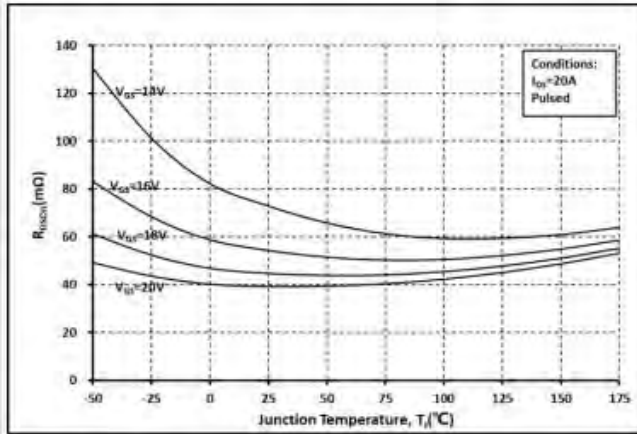

图. 9 阈值电压随温度变化曲线

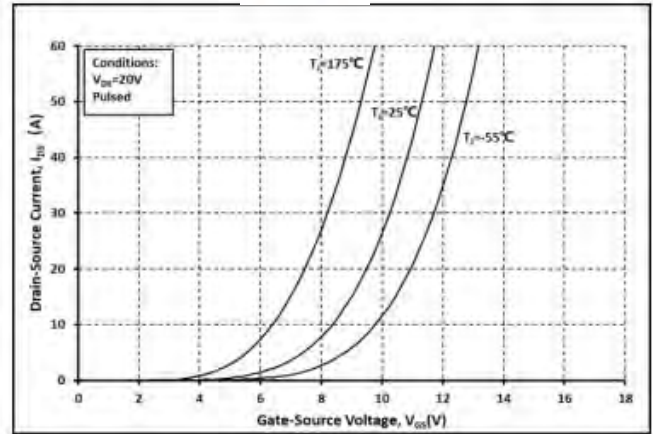

图. 10 体二极管导通曲线 @ $T_j = -55^\circ\text{C}$

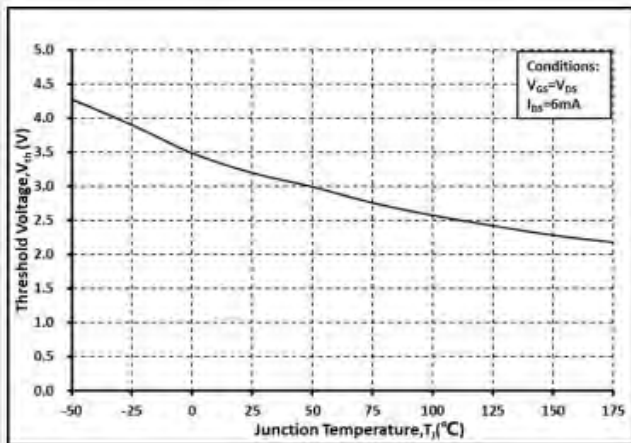

图. 11 体二极管导通曲线 @ $T_j = 25^\circ\text{C}$

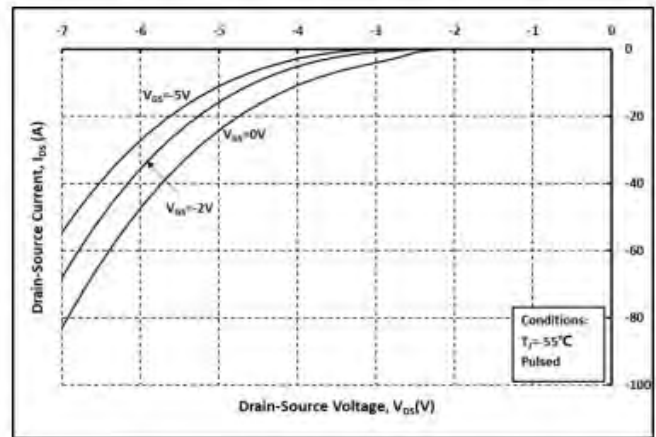

图. 12 体二极管导通曲线 @ $T_j = 175^\circ\text{C}$

Caution: This device is sensitive to electrostatic discharge .Users should follow ESD handing procedures.

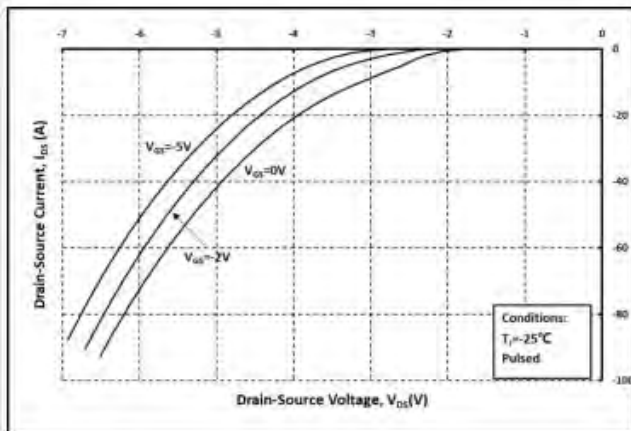

图. 13 第三象限曲线 @ $T_j = -55^\circ\text{C}$

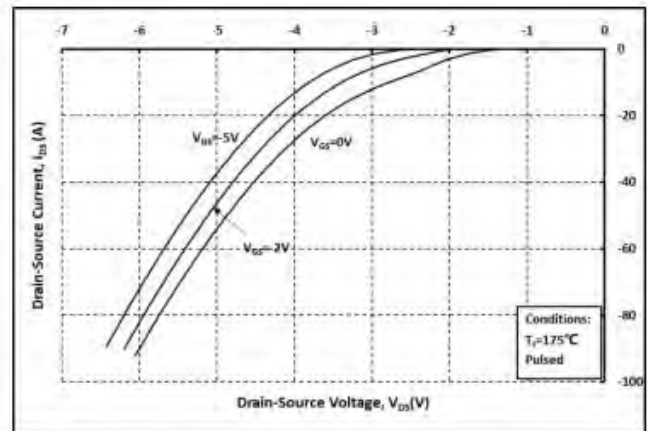

图. 14 第三象限曲线 @ $T_j = 25^\circ\text{C}$

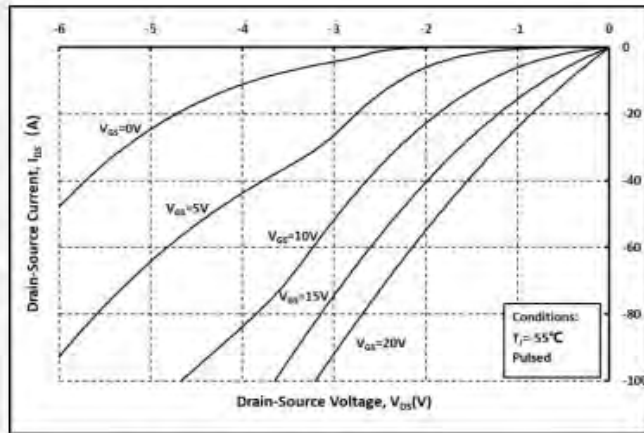

图. 15 第三象限曲线 @ $T_j = 175^\circ\text{C}$

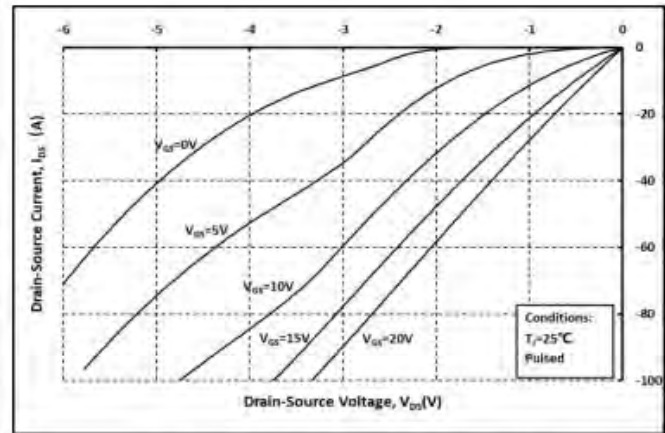

图. 16 各电容和 V_{DS} 关系曲线

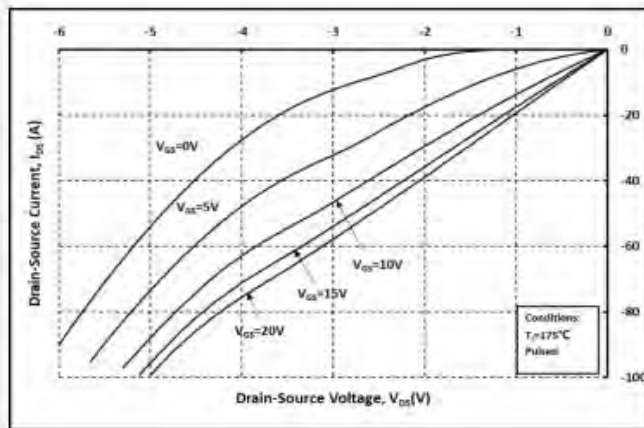

图. 17 输出电容存储能量曲线 c

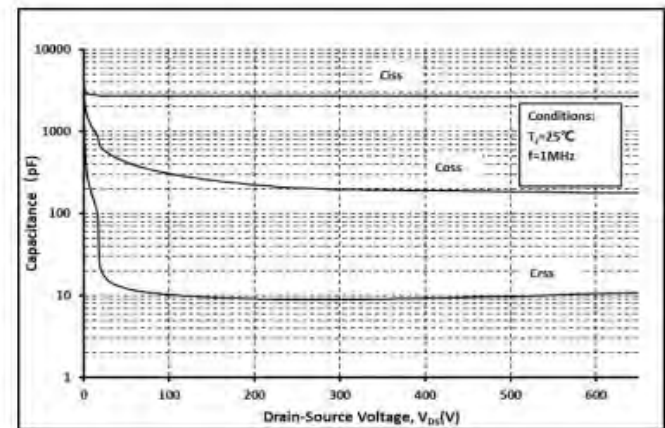

图. 18 栅电荷特征曲线 c

Caution: This device is sensitive to electrostatic discharge .Users should follow ESD handling procedures.

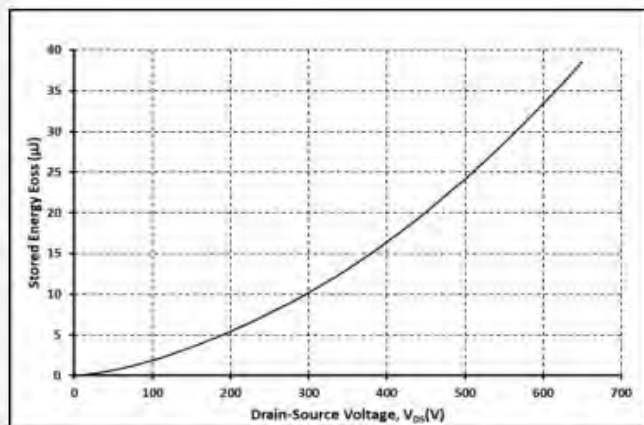

图. 19 开关能量和栅极电阻 $R_{G(ext)}$ 关系曲线

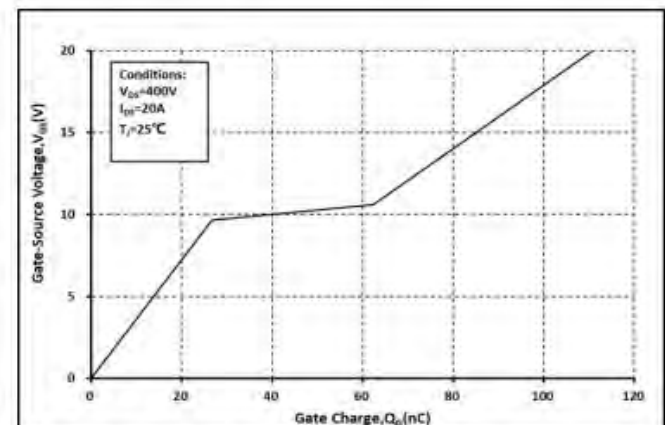

图. 20 开关时间和栅极电阻 $R_{G(ext)}$ 关系曲线

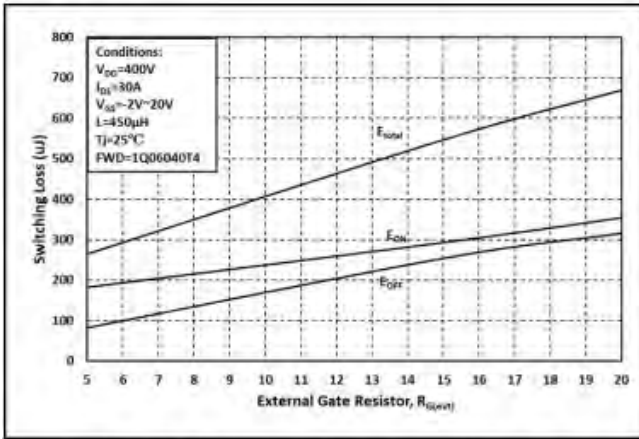

图. 21 漏端电流和温度关系曲线

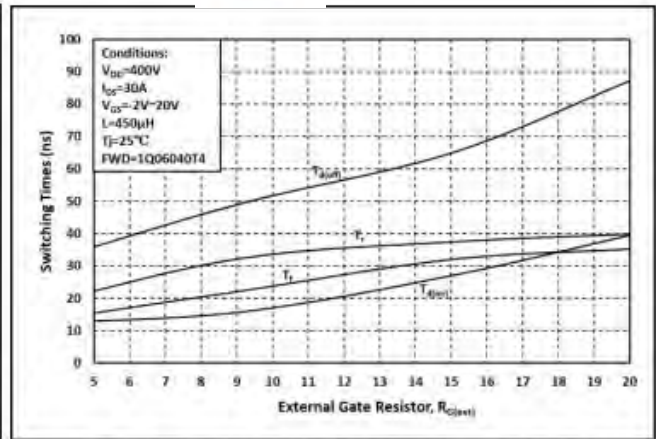

图. 22 最大功耗降额和温度关系曲线

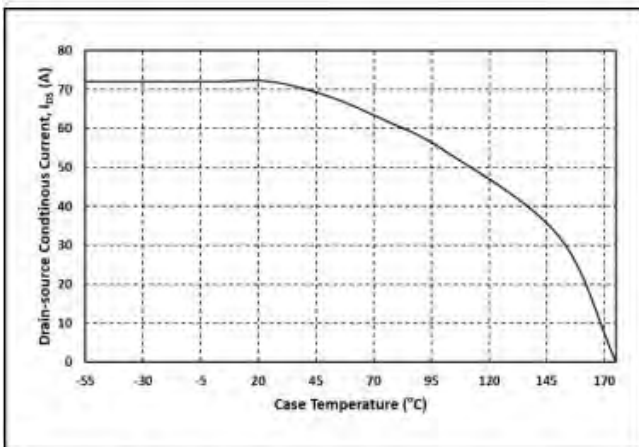

图. 23 热阻曲线

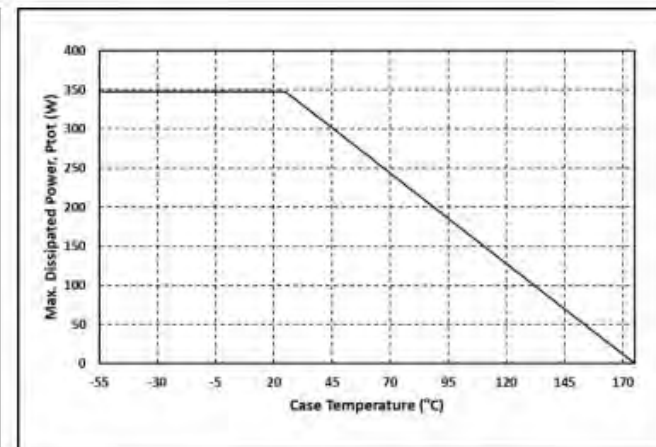

图. 24 安全工作区示意图

Caution: This device is sensitive to electrostatic discharge .Users should follow ESD handling procedures.

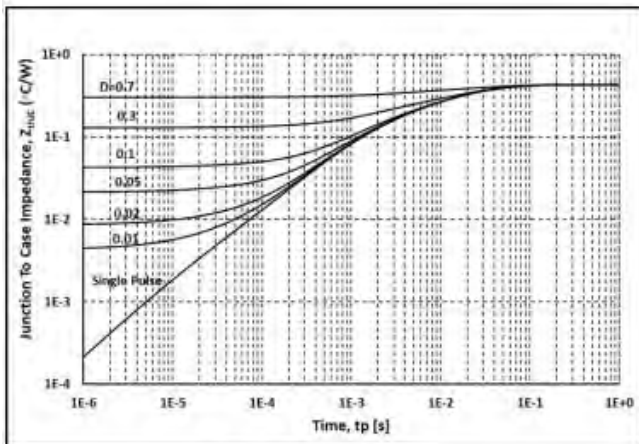

Recommended Solder Pad Layout

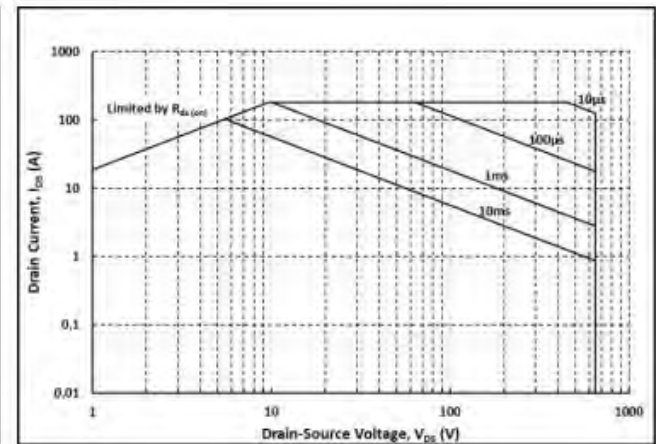
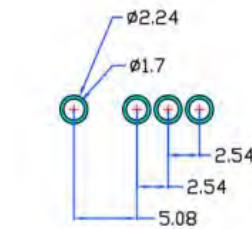
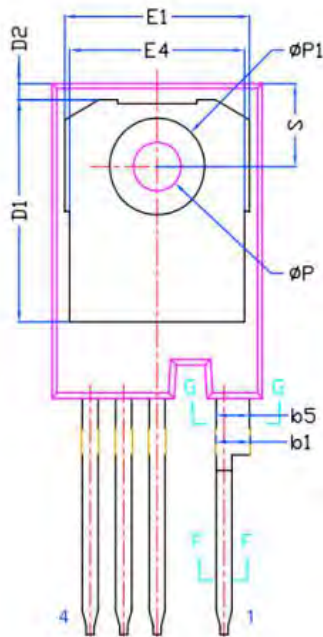
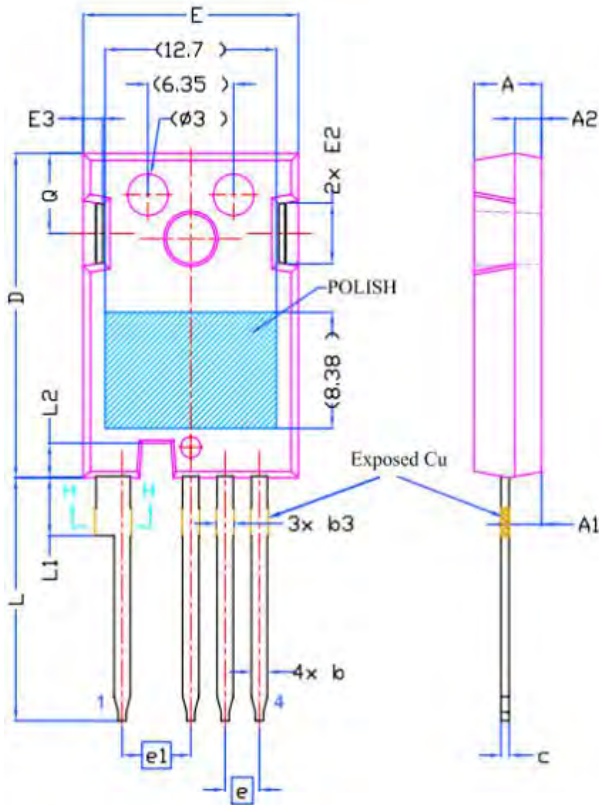
SYMBOL	DIMENSIONS		
	MIN.	NOM.	MAX.
A	4.83	5.02	5.21
A1	2.29	2.41	2.54
A2	1.91	2.00	2.16
b'	1.07	1.20	1.28
b	1.07	1.20	1.33
b1	2.39	2.67	2.94
b2	2.39	2.67	2.84
b3	1.07	1.30	1.60
b4	1.07	1.30	1.50
b5	2.39	2.53	2.69
b6	2.39	2.53	2.64
c	0.55	0.60	0.68
c1	0.55	0.60	0.65
D	23.30	23.45	23.60
D1	16.25	16.55	17.65
D2	0.95	1.19	1.25
E	15.75	15.94	16.13
E1	13.10	14.02	14.15
E2	3.68	4.40	5.10
E3	1.00	1.45	1.90
E4	12.38	13.26	13.43
e	2.54 BSC		
e1	5.08 BSC		
L	17.31	17.57	17.82
L1	3.97	4.19	4.37
L2	2.35	2.50	2.65
∅P	3.51	3.61	3.65
∅P1	7.19 REF.		
Q	5.49	5.79	6.00
S	6.04	6.17	6.30

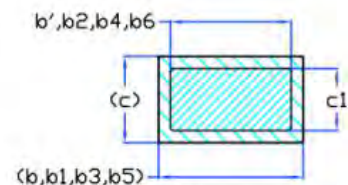

Section F--F, G--G, H--H

Note:

1. Package Reference: JEDEC TO247, Variation AD
2. All Dimensions are in mm
3. Slot Required, Notch May Be Rounded
4. Dimension D&E Do Not Include Mold Flash

Caution: This device is sensitive to electrostatic discharge .Users should follow ESD handing procedures.