



LGE3M160120Q

Silicon Carbide Power MOSFET



Features

- High voltage, low on resistance
- High speed, low parasitic capacitance
- High junction temperature
- Fast recovery diode
- Kelvin connection driver

$V_{DS} = 1200\text{ V}$
 $I_D@25^\circ\text{C} = 20\text{ A}$
 $R_{DS(ON)} = 160\text{ m}\Omega$

Benefits

- Higher System Efficiency
- Parallel Device Convenience without thermal runaway
- High Temperature Application
- Hard Switching & Higher Reliability
- Easy to drive

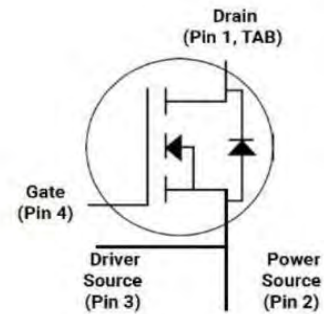

Applications

- motor drive
- Photovoltaic inverter
- UPS power supply
- High voltage DC / DC converter
- Switching Mode Power Supply

TO-247-4L Pin definition

Key performance parameters

Type	V_{DS}	I_D $T_C=25^\circ\text{C}$	$R_{DS(ON)}$
LGE3M160120Q	1200V	20A	160m Ω

Caution: This device is sensitive to electrostatic discharge .Users should follow ESD handling procedures.



LGE3M160120Q

Silicon Carbide Power MOSFET



Maximum Ratings

$T_C=25^{\circ}\text{C}$, unless otherwise specified

Parameter	Symbol	Value	Unit
Drain-source voltage $V_{GS} = 0\text{V}$, $I_D = 100 \mu\text{A}$	V_{DS}	1200	V
Gate-source voltage Recommended maximum	V_{GS}	-5 to 20	V

Maximum Ratings

$T_C=25^{\circ}\text{C}$, unless otherwise specified

Parameter	Symbol	Value	Unit
Continuous drain current : $V_{GS} = 20\text{V}$ $T_C = 25^{\circ}\text{C}$ $T_C = 100^{\circ}\text{C}$	I_D	20 16	A
Pulsed drain current: Pulse width limited by SOA	I_{DM}	50	A
Power dissipation : $T_C = 25^{\circ}\text{C}$	P_{TOT}	138	W
Storage temperature range :	T_{stg}	-55 to +175	$^{\circ}\text{C}$
Operating and junction temperature:	T_j	-55 to +175	$^{\circ}\text{C}$
Soldre temperature: Wave soldering only allowed at leads, 1.6 mm from case for 10 s	T_L	260	$^{\circ}\text{C}$

Thermal Resistance

Parameter	Symbol	Typ.	Unit
Thermal resistance to shell	R_{thJC}	1.088	$^{\circ}\text{C}/\text{W}$

Caution: This device is sensitive to electrostatic discharge .Users should follow ESD handling procedures.



LGE3M160120Q

Silicon Carbide Power MOSFET



Electrical Characteristic

$T_C = 25^\circ\text{C}$, unless otherwise specified

Parameter	Symbol	Value			Unit	Test Condition
		Min.	Typ.	Max.		
Zero gate voltage drain current	I_{DSS}		5	100	μA	$V_{DS} = 1200\text{V}$ $V_{GS} = 0\text{V}$
Gate leakage current	I_{GSS}		1	± 100	nA	$V_{DS} = 0\text{V}$ $V_{GS} = -5\sim 20\text{V}$
Gate threshold voltage	V_{TH}		2.9 1.9		V	$V_{GS} = V_{DS}$ $I_D = 1.9\text{mA}$ $T_C = 175^\circ\text{C}$
Drain-source on-state resistance	R_{ON}		160 250	195	$\text{m}\Omega$	$V_{GS} = 20\text{V}$ $I_D = 10\text{A}$ $T_J = 25^\circ\text{C}$ $T_J = 175^\circ\text{C}$
Input capacitance	C_{iss}		885		pF	$V_{DS} = 800\text{V}$ $V_{GS} = 0\text{V}$ $f = 1\text{MHz}$ $V_{AC} = 25\text{mV}$
Output capacitance	C_{oss}		38			
Reverse transfer capacitance	C_{rss}		2			
The output capacitor stores energy	E_{oss}		16		μJ	
Total gate charge	Q_g		43		nC	$V_{DS} = 800\text{V}$ $I_D = 10\text{A}$ $V_{GS} = -5\text{ to } 20\text{V}$
Gate to source charge	Q_{gs}		9			
Gate to drain charge	Q_{gd}		19			
Gate input resistance	R_g		9.5		Ω	$f = 1\text{MHz}$
Turn-on switching energy	E_{ON}		139.3		μJ	$V_{DS} = 800\text{V}$, $I_D = 10\text{A}$, $V_{GS} = -2\text{ to } 20\text{V}$, $R_{G(ext)} = 5.1\Omega$, $L = 450\mu\text{H}$
Turn-off switching energy	E_{OFF}		39.2		μJ	
Turn-on delay time	$t_{d(on)}$		6.4		ns	
Rise time	t_r		19.4			
Turn-off delay time	$t_{d(off)}$		11.8			

Caution: This device is sensitive to electrostatic discharge .Users should follow ESD handling procedures.



LGE3M160120Q

Silicon Carbide Power MOSFET



Fall time	t_f		14			
-----------	-------	--	----	--	--	--

Reverse Diode Characteristics

$T_c = 25^\circ\text{C}$, unless otherwise specified

Parameter	Symbol	Value			Unit	Test Condition
		Min.	Typ.	Max.		
Diode forward voltage	V_{SD}		4.1 3.7		V	$I_{SD} = 5\text{A}$ $V_{GS} = 0\text{V}$ $T_J = 175^\circ\text{C}$
Reverse recovery time	t_{rr}		33.2		ns	$V_{GS} = -2\text{V}/+20\text{V}$, $I_{SD} = 10\text{A}$, $V_R = 800\text{V}$, $di/dt = 1000\text{A}/\mu\text{s}$, $R_{G(\text{ext})} = 13\Omega$
Reverse recovery charge	Q_{rr}		101.5		nC	
Reverse recovery peak current	I_{RRM}		5.6		A	

Caution: This device is sensitive to electrostatic discharge .Users should follow ESD handing procedures.



Characteristics Curves



图.1 输出曲线 @ $T_j = -55^\circ\text{C}$



图.2 输出曲线 @ $T_j = 25^\circ\text{C}$

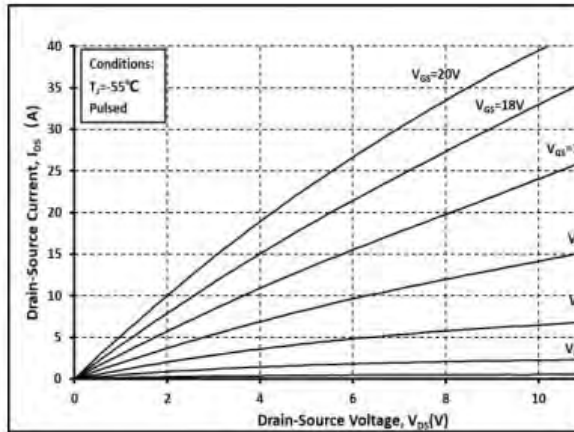

图.3 输出曲线 @ $T_j = 175^\circ\text{C}$

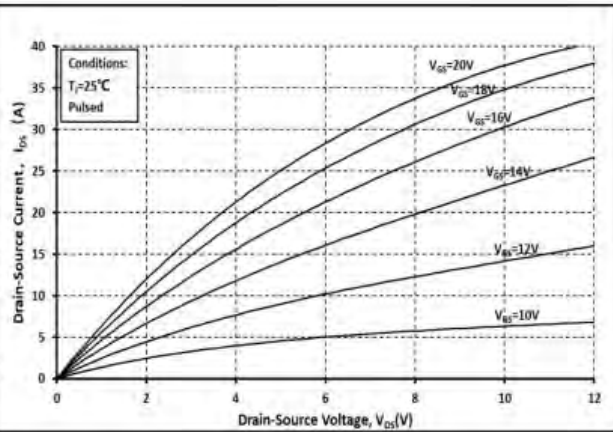

图.4 R_{on} 和温度关系曲线

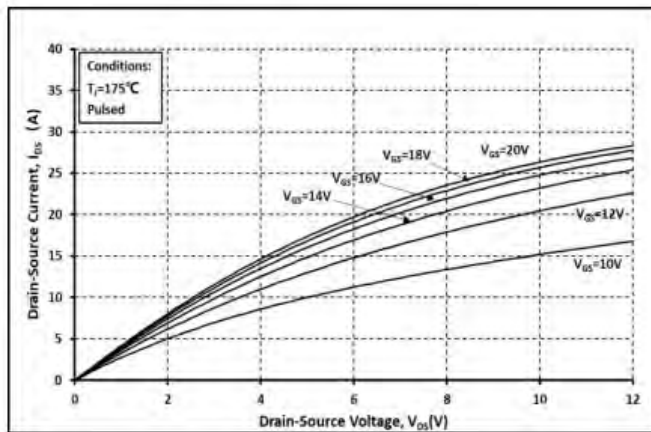

图.5 归一化的 R_{on} 和温度关系曲线

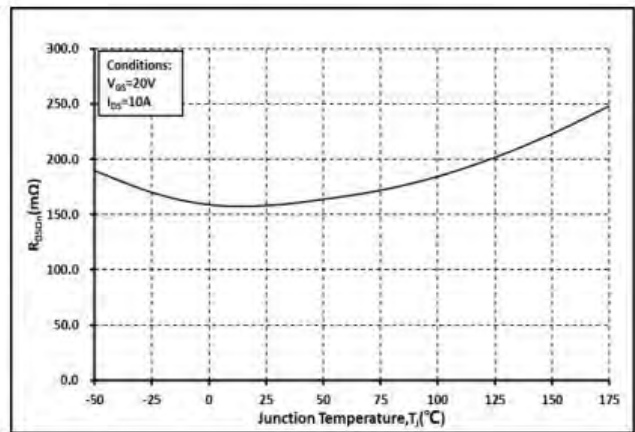

图.6 各温度下的 R_{on} 和 I_{DS} 关系曲线

Caution: This device is sensitive to electrostatic discharge .Users should follow ESD handling procedures.

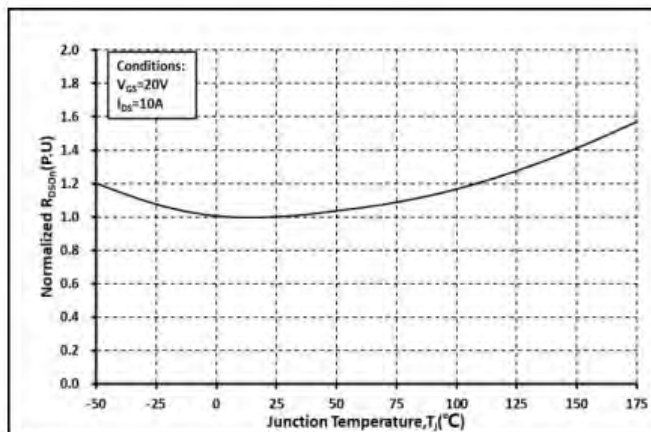

图. 7 各 V_{GS} 下的 R_{on} 和温度关系曲线

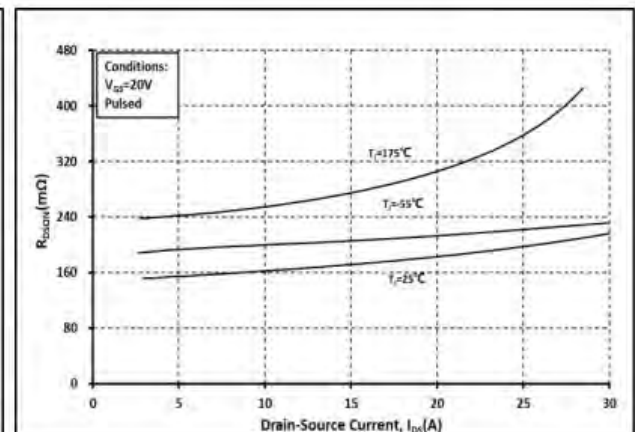

图. 8 各温度下的传输特性曲线

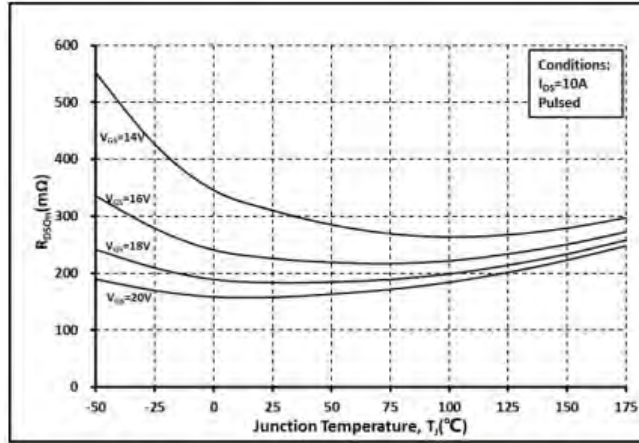

图. 9 阈值电压随温度变化曲线

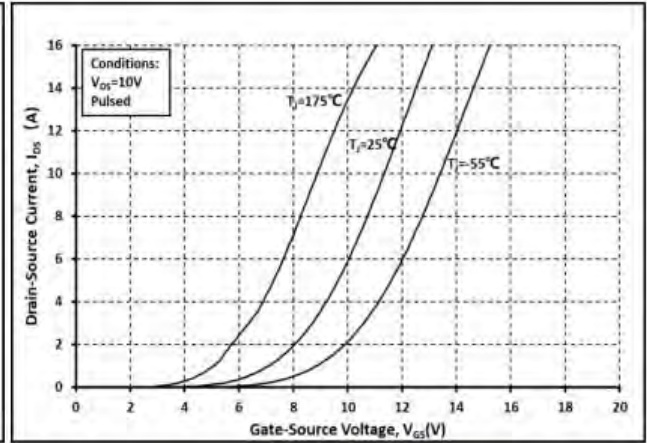

图. 10 体二极管导通曲线 @ $T_j=-55^{\circ}C$

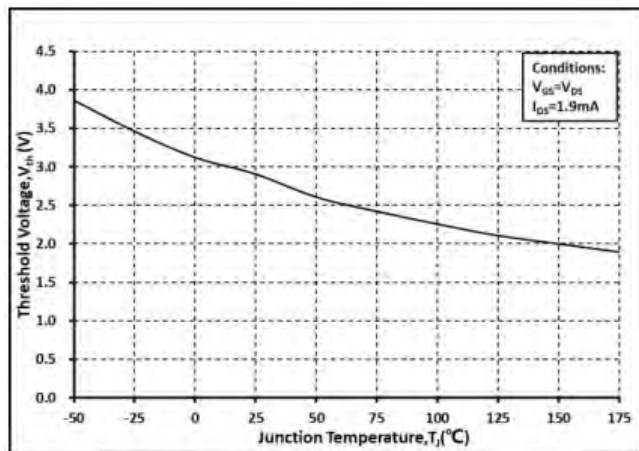

图. 11 体二极管导通曲线 @ $T_j=25^{\circ}C$

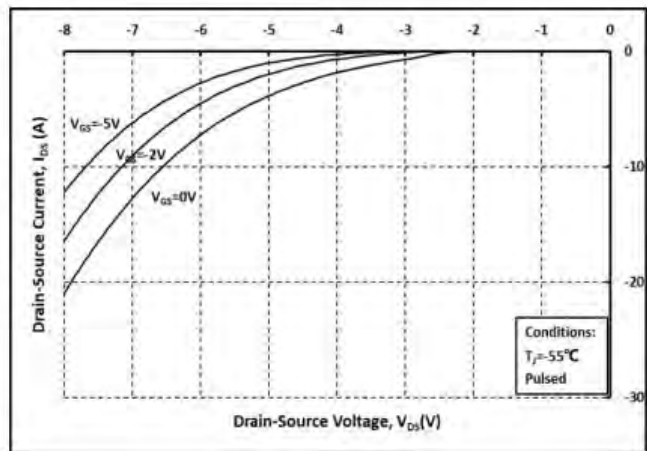

图. 12 体二极管导通曲线 @ $T_j=175^{\circ}C$

Caution: This device is sensitive to electrostatic discharge .Users should follow ESD handing procedures.

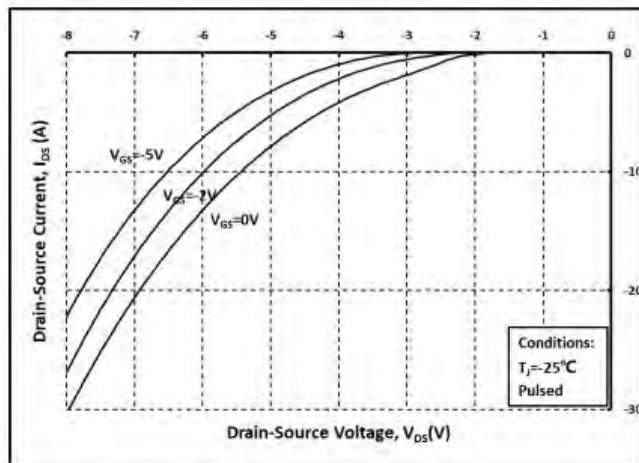

图. 13 第三象限曲线 @ $T_j = -55^\circ\text{C}$

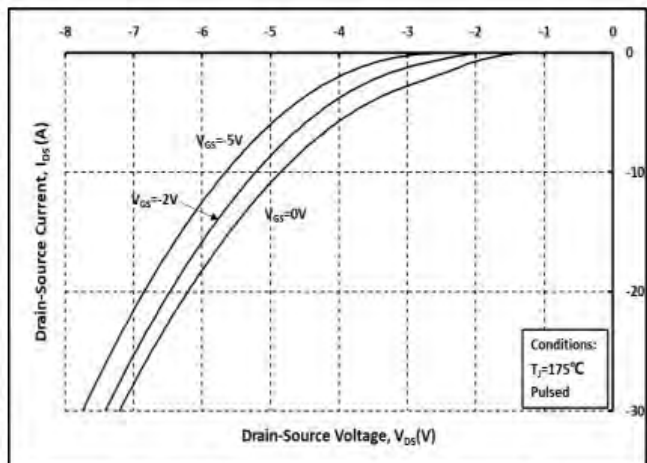

图. 14 第三象限曲线 @ $T_j = 25^\circ\text{C}$

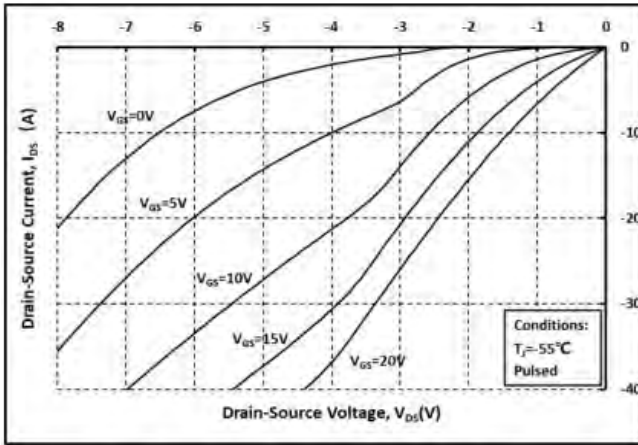

图. 15 第三象限曲线 @ $T_j = 175^\circ\text{C}$

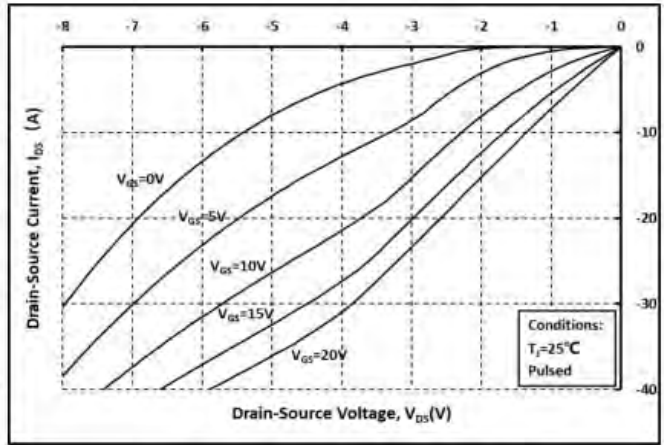

图. 16 各电容和 V_{DS} 关系曲线

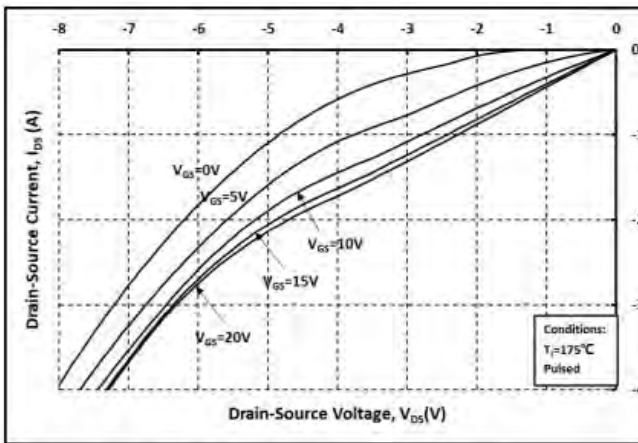

图. 17 输出电容存储能量曲线

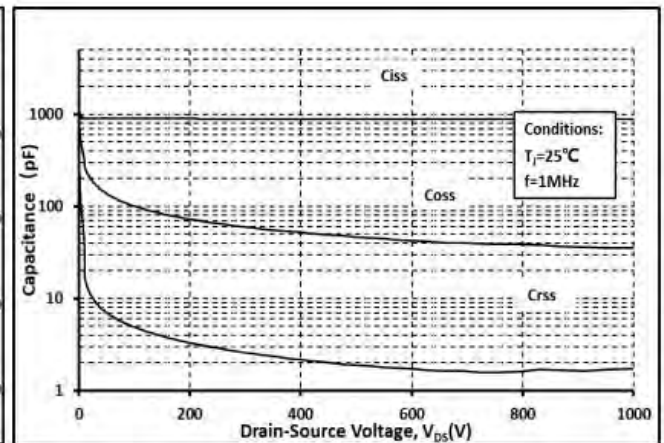

图. 18 栅电荷特征曲线

Caution: This device is sensitive to electrostatic discharge .Users should follow ESD handling procedures.

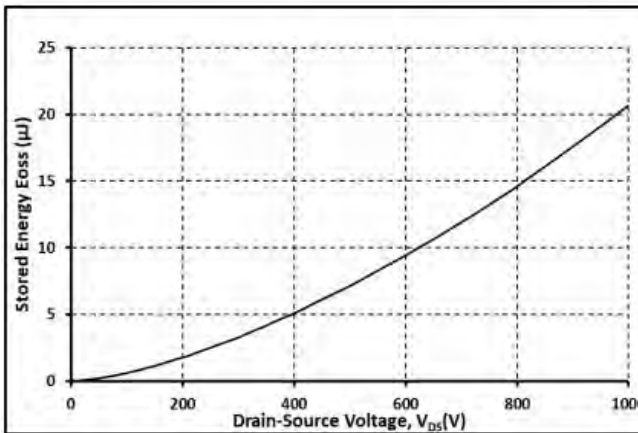

图. 19 开关能量和栅极电阻 $R_{G(ext)}$ 关系曲线

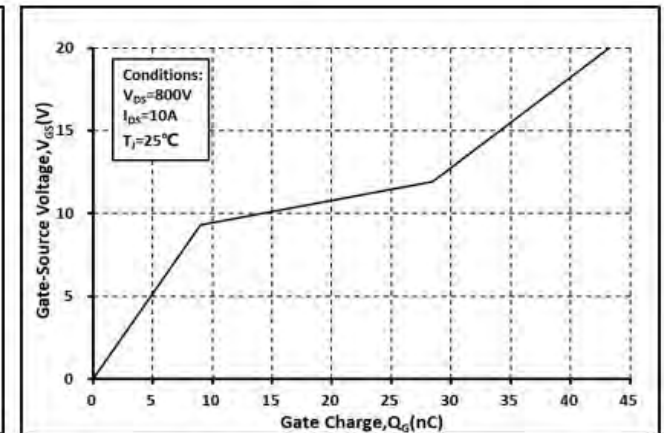

图. 20 开关时间和栅极电阻 $R_{G(ext)}$ 关系曲线

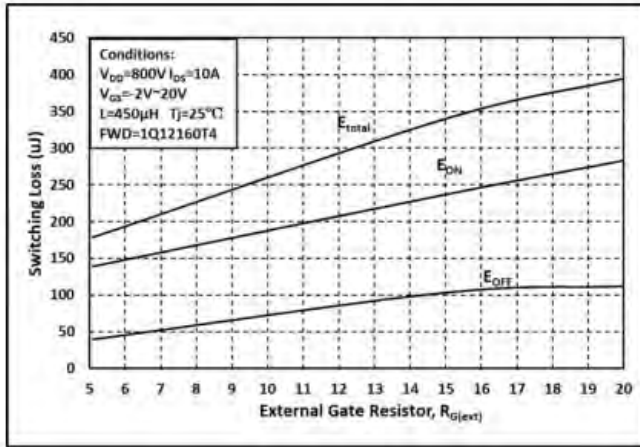

图. 21 漏端电流和温度关系曲线

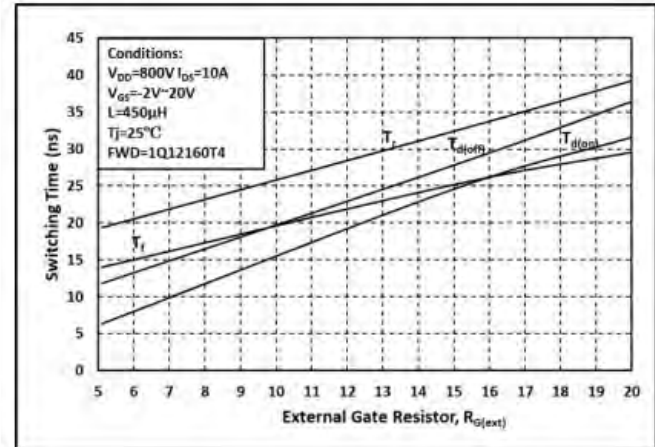

图. 22 最大功耗降额和温度关系曲线

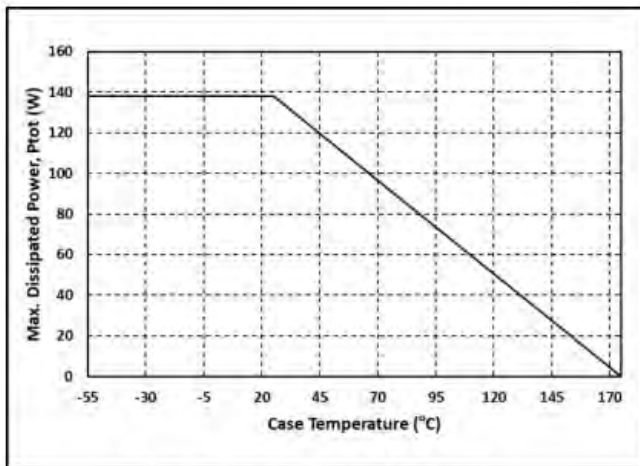

图. 23 热阻曲线

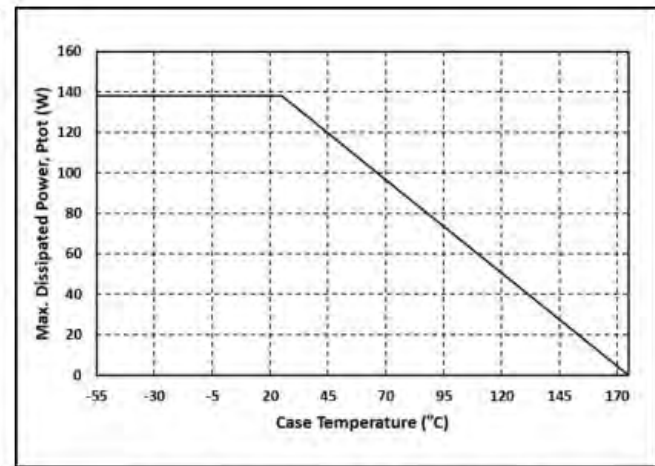

图. 24 安全工作区示意图

Caution: This device is sensitive to electrostatic discharge .Users should follow ESD handling procedures.

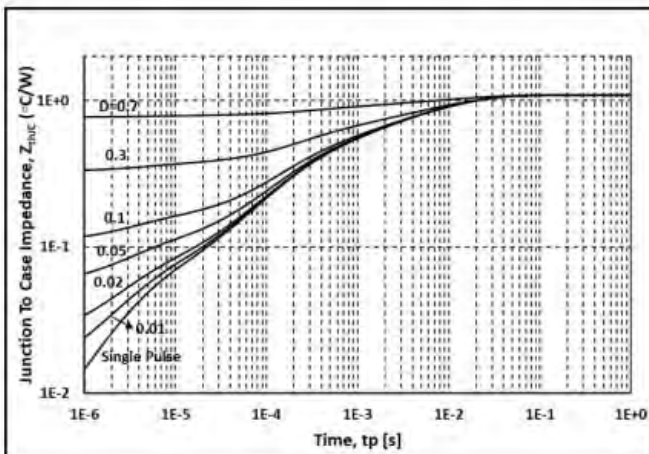

Recommended Solder Pad Layout

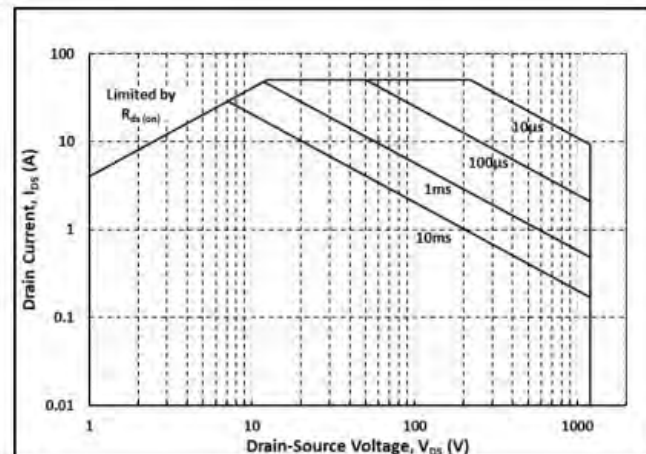
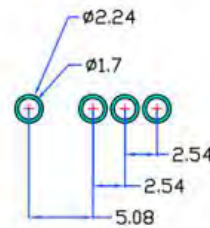
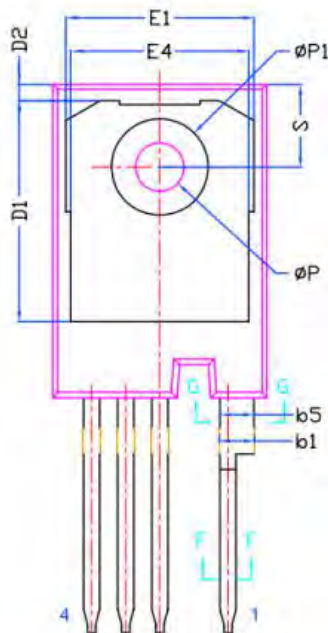
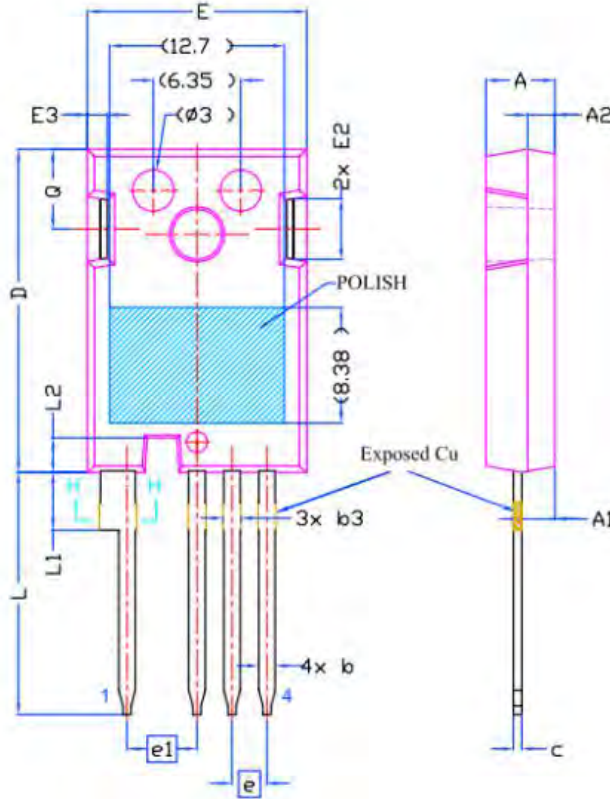
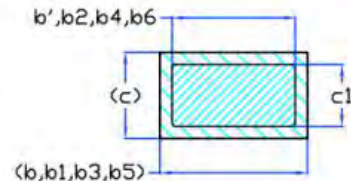

Section F--F, G--G, H--H

SYMBOL	DIMENSIONS		
	MIN.	NOM.	MAX.
A	4.83	5.02	5.21
A1	2.29	2.41	2.54
A2	1.91	2.00	2.16
b'	1.07	1.20	1.28
b	1.07	1.20	1.33
b1	2.39	2.67	2.94
b2	2.39	2.67	2.84
b3	1.07	1.30	1.60
b4	1.07	1.30	1.50
b5	2.39	2.53	2.69
b6	2.39	2.53	2.64
c	0.55	0.60	0.68
c1	0.55	0.60	0.65
D	23.30	23.45	23.60
D1	16.25	16.55	17.65
D2	0.95	1.19	1.25
E	15.75	15.94	16.13
E1	13.10	14.02	14.15
E2	3.68	4.40	5.10
E3	1.00	1.45	1.90
E4	12.38	13.26	13.43
e	2.54 BSC		
e1	5.08 BSC		
L	17.31	17.57	17.82
L1	3.97	4.19	4.37
L2	2.35	2.50	2.65
ØP	3.51	3.61	3.65
ØP1	7.19 REF.		
Q	5.49	5.79	6.00
S	6.04	6.17	6.30

说明:

1. 封装标准参考: : JEDEC TO247, Variation AD
2. 以上单位为: 毫米
3. 需要开槽, 槽口可为圆形
4. 尺寸 D 和 E 不包括模具溢料

Caution: This device is sensitive to electrostatic discharge .Users should follow ESD handling procedures.