



Driver LCI 220W 500-1400mA pD NF h28 PRE4 (INDUSTRY)
premium series non-SELV

Product description

- Constant current built-in Driver for LED, particularly suitable for industrial applications in tough environments with elevated ambient temperatures such as warehouses or factories
- Dimming range 1 – 100 %
- For luminaires of protection class I and protection class II
- Adjustable output current between 500 and 1,400 mA
- Max. output power 220 W
- Suitable for mains voltage peaks (burst/surge) up to 4 kV
- Expanded temperature range of -40 ... +75 °C
- Nominal lifetime up to 100,000 h
- 8 years guarantee (conditions at www.tridonic.com)

Housing properties

- White slim metal casing
- Type of protection IP20

Interfaces

- Near field communication (NFC)
- one4all (DALI-2 DT6, DSI, switchDIM, corridorFUNCTION)
- Terminal blocks: 0° push terminals

Functions

- Adjustable output current in 1-mA-steps (NFC, DALI)
- Fulfills DALI-2 parts: 250 (Integrated bus power supply), 251 (Luminaire data), 252 (Energy reporting) and 253 (Diagnostics & Maintenance)
- Constant light output function (eCLO)
- Intelligent Temperature Guard (overtemperature protection)
- Intelligent Voltage Guard (overvoltage and undervoltage monitoring)
- Protective features (overtemperature, short-circuit, overload, no-load, input voltage range)
- Suitable for emergency lighting acc. to EN 50172

Benefits

- Flexible configuration via companionSUITE (NFC, DALI)
- Application-oriented operating window for maximum compatibility
- Extended vibration damping
- Increased safety through robust design and advanced testing under extreme test conditions
- High reliability through the selection of exclusive components

Typical applications

- For linear/area lighting in industry applications



Standards, page 3

Data sheet 09/22-LC945-0

Subject to change without notice. Information provided without guarantee.



Driver LCI 220W 500-1400mA pD NF h28 PRE4 (INDUSTRY) premium series non-SELV

Technical data

Rated supply voltage	220 – 240 V
AC voltage range	198 – 264 V
DC voltage range	176 – 280 V
Mains frequency	0 / 50 / 60 Hz
Overvoltage protection	320 V AC, 48 h
Typ. current (at 230 V, 50 Hz, full load) ^{① ②}	1,011 mA
Typ. current (220 V, 0 Hz, full load, EOFx dimlevel) ^{① ②}	174 mA
Leakage current (at 230 V, 50 Hz, full load) ^{① ②}	< 300 µA
Max. input power	230 W
Output power range (P _{rated})	40 – 220 W
Typ. efficiency (at 230 V / 50 Hz / full load) ^{② ③}	97 %
λ (at 230 V, 50 Hz, full load) ^①	0.99
λ (over full operating range)	0.86C – 0.99
Typ. power consumption on stand-by ^③	< 0.14 W
Typ. input current in no-load operation ^③	< 84 mA
Typ. input power in no-load operation ^③	< 0.35 W
In-rush current (peak / duration)	25 A / 210 µs
THD (at 230 V, 50 Hz, full load) ^①	< 5 %
Starting time (at 230 V, 50 Hz, full load) ^①	< 0.7 s
Starting time (DC mode)	< 0.7 s
Switchover time (AC/DC) ^③	< 0.3 s
Turn off time (at 230 V, 50 Hz, full load)	< 0.01 s
Output current tolerance ^{① ②}	± 3 %
Max. output current peak (non-repetitive)	≤ Output current + 40 %
Output LF current ripple (< 120 Hz) ^①	± 1 %
Output P _{ST} ^{LM} (at full load)	≤ 1
Output SVM (at full load)	≤ 0.4
Max. output voltage (no-load voltage)	320 V
Dimming range	1 – 100 % (min. 14 mA)
Mains surge capability (between L – N)	4 kV
Mains surge capability (between L/N – PE)	4 kV
Surge voltage at output side (against PE)	4 kV
Type of protection	IP20
Lifetime	up to 100,000 h
Guarantee (conditions at www.tridonic.com)	8 years
Dimensions L x W x H	360 x 30 x 28 mm

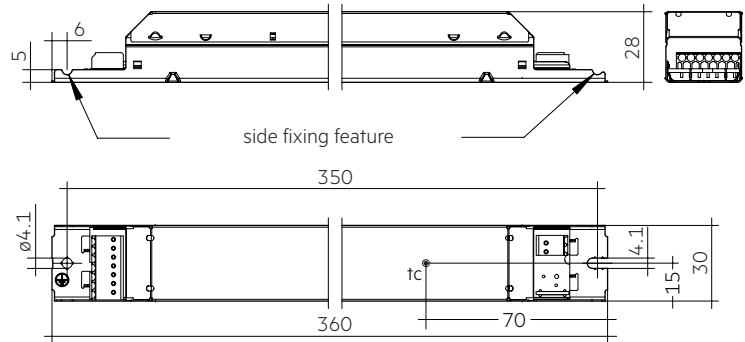

Ordering data

Type	Article number	Packaging carton	Packaging pallet	Weight per pc.
LCI 220/500-1400/500 pD NF h28 PRE4	28004039	10 pc(s).	600 pc(s).	0.355 kg

Specific technical data

Type	Output current ^①	Min. forward voltage	Max. forward voltage	Max. output power	Typ. power consumption (at 230 V, 50 Hz, full load)	Typ. current consumption (at 230 V, 50 Hz, full load)	Max. casing temperature tc	Ambient temperature ta max.
LCI 220/500-1400/500 pD NF h28 PRE4	500 mA	80 V	300.0 V	150 W	155.5 W	692 mA	88 °C	-40 ... +75 °C
	600 mA	80 V	300.0 V	180 W	186.4 W	825 mA	88 °C	-40 ... +75 °C
	700 mA	80 V	300.0 V	210 W	217.4 W	958 mA	87 °C	-40 ... +70 °C
	800 mA	80 V	275.0 V	220 W	227.9 W	1,003 mA	87 °C	-40 ... +70 °C
	900 mA	80 V	244.4 V	220 W	228.1 W	1,005 mA	89 °C	-40 ... +70 °C
	1,000 mA	80 V	220.0 V	220 W	228.5 W	1,006 mA	89 °C	-40 ... +70 °C
	1,100 mA	80 V	200.0 V	220 W	228.7 W	1,007 mA	88 °C	-40 ... +65 °C
	1,200 mA	80 V	183.3 V	220 W	229.0 W	1,009 mA	88 °C	-40 ... +65 °C
	1,300 mA	80 V	169.2 V	220 W	229.3 W	1,010 mA	92 °C	-40 ... +65 °C
	1,400 mA	80 V	157.1 V	220 W	229.7 W	1,011 mA	92 °C	-40 ... +65 °C

① Valid at 100 % dimming level.

② Depending on the selected output current.

③ Depending on the DALI traffic at the interface. DALI bus power supply deactivated.

④ Valid for immediate change of power supply type otherwise the starting time is valid.

⑤ Output current is mean value.

⑥ The table only lists a number of possible operating points but does not cover each single point. The output current can be set within the total value range in 1-mA-steps.

1. Standards

EN 55015
 EN 60068-2-27 (shock – test case: 1,000 shocks in 6 directions with 30 g / 18 ms)
 EN 60068-2-64 (vibration – test case: acc. to table A.1 transport / category 2)
 EN 61000-3-2
 EN 61000-3-3
 EN 61347-1
 EN 61347-2-13
 EN 62384
 EN 61547
 EN 62386-101 (DALI-2)
 EN 62386-102 (DALI-2)
 EN 62386-207 (DALI-2, including part 250, 251, 252, 253)
 According to EN 50172 for use in central battery systems
 According to EN 60598-2-22 suitable for emergency lighting installations

2. Thermal details and lifetime

2.1 Expected lifetime

Type	Output current	ta	50 °C	55 °C	60 °C	65 °C	70 °C	75 °C
LCI 220/500-1400/500 pD NF h28 PRE4	< 500 – 600 mA	tc	64 °C	69 °C	74 °C	78 °C	83 °C	88 °C
		Lifetime	> 100,000 h	> 100,000 h	> 100,000 h	> 100,000 h	80,000 h	57,000 h
	> 600 – 800 mA	tc	66 °C	71 °C	76 °C	82 °C	87 °C	–
		Lifetime	> 100,000 h	> 100,000 h	> 100,000 h	82,000 h	58,000 h	–
	> 800 – 1,000 mA	tc	71 °C	76 °C	80 °C	85 °C	89 °C	–
		Lifetime	> 100,000 h	> 100,000 h	> 100,000 h	70,000 h	53,000 h	–
	> 1,000 – 1,200 mA	tc	72 °C	77 °C	82 °C	88 °C	–	–
		Lifetime	> 100,000 h	> 100,000 h	91,000 h	60,000 h	–	–
	> 1,200 – 1,400 mA	tc	77 °C	82 °C	87 °C	92 °C	–	–
		Lifetime	> 100,000 h	97,000 h	68,000 h	50,000 h	–	–

The LED driver is designed for a lifetime stated above under reference conditions and with a failure probability of less than 10 %.

The relation of tc to ta temperature depends also on the luminaire design.

If the measured tc temperature is approx. 5 K below tc max., ta temperature should be checked and eventually critical components (e.g. ELCAP) measured. Detailed information on request.

3. Installation / wiring

3.1 Circuit diagram

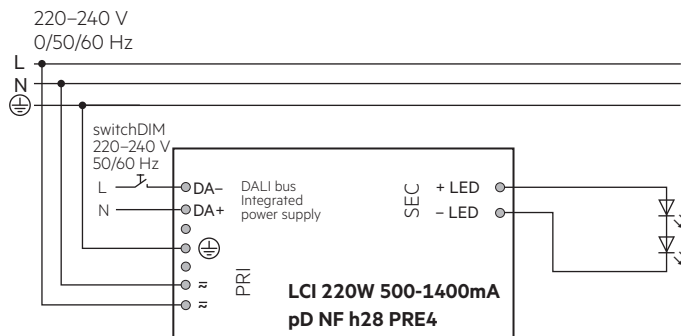
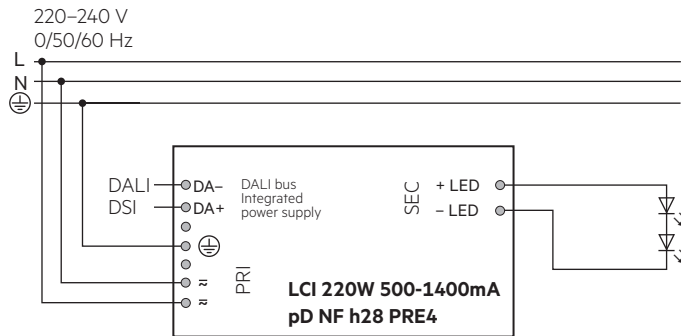

DALI bus power supply has to be deactivated when using switchDIM or corridorFUNCTION. Otherwise it could be damaged.

3.2 Wiring type and cross section

For wiring use solid wire from 0.5 – 1.5 mm². Strip 8 – 9 mm of insulation from the cables to ensure perfect operation of terminals.

LED module/LED driver/supply

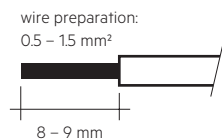

3.3 Loose wiring

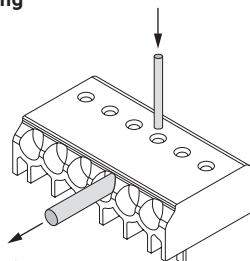

Loosen wire through twisting and pulling or using a \varnothing 1 mm release tool

3.4 Wiring guidelines

- The cables should be run separately from the mains connections and mains cables to ensure good EMC conditions.
- The LED wiring should be kept as short as possible to ensure good EMC. The max. secondary cable length is 2 m (4 m circuit).
- Secondary switching is not permitted.
- The LED driver has no inverse-polarity protection on the secondary side. Wrong polarity can damage LED modules with no inverse-polarity protection.
- Wrong wiring of the LED driver can lead to malfunction or irreparable damage.
- With mains transients of 4 kV can voltage peaks up to 4 kV occur against PE at the output of the LED driver. This has to be considered concerning the dielectric strength of the LED module (insulation against PE).
- To avoid the damage of the Driver, the wiring must be protected against short circuits to earth (sharp edged metal parts, metal cable clips, louver, etc.).

3.5 Hot plug-in



Hot plug-in is not supported due to residual output voltage of > 0 V up to mains voltage. Danger to life.

When connecting an LED load, restart the device to activate the LED output.

This can be done via mains reset or via interface (DALI, DSI, switchDIM).

3.6 Earth connection

The earth connection is conducted as protection earth (PE). The LED driver can be earthed via earth terminal or metal housing. If the LED driver will be earthed, protection earth (PE) has to be used. There is no earth connection required for the functionality of the LED driver. Earth connection is recommended to improve following behaviour:

- Electromagnetic interferences (EMI)
- Transmission of mains transients to the LED output

In general it is recommended to earth the LED driver if the LED module is mounted on earthed luminaire parts respectively heat sinks and thereby representing a high capacity against earth.

3.7 Replace LED module

1. Mains off
2. Remove LED module
3. Wait for 30 seconds
4. Connect LED module again

Hot plug-in or secondary switching of LEDs is not permitted and may cause a very high current to the LEDs.

3.8 Industry application

This driver is designed for industry applications.

Due to the high performance of the driver, there may be a slightly increased noise level.

The starting sound, when switching on the driver, can possibly be heard more.

The nominal lifetime of 100,000 hours and its temperatures are designed for standard applications.

However, the driver can also withstand higher temperatures, which are shown in Table 2.1.

At high temperatures, the lifetime is reduced accordingly.

4. Electrical values

4.1 Operating window

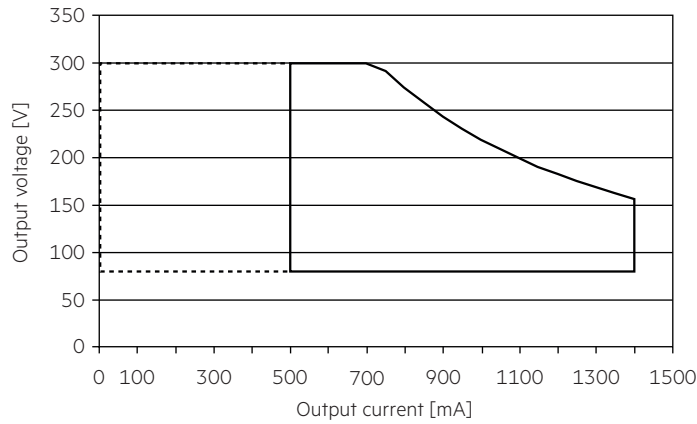

Make sure that the LED driver is operated within the given window under all operating conditions.

4.3 Power factor vs load

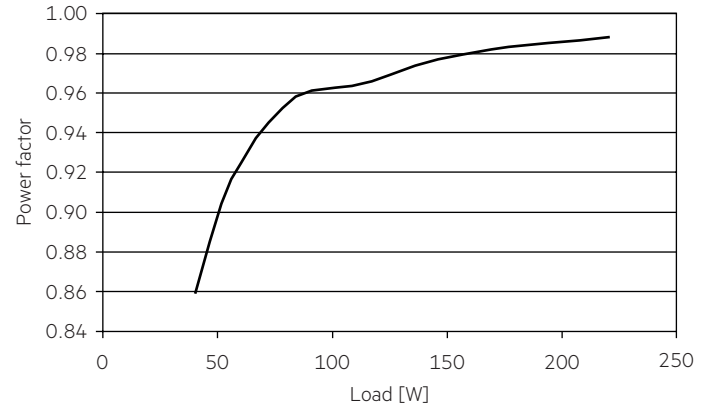

4.2 Efficiency vs load

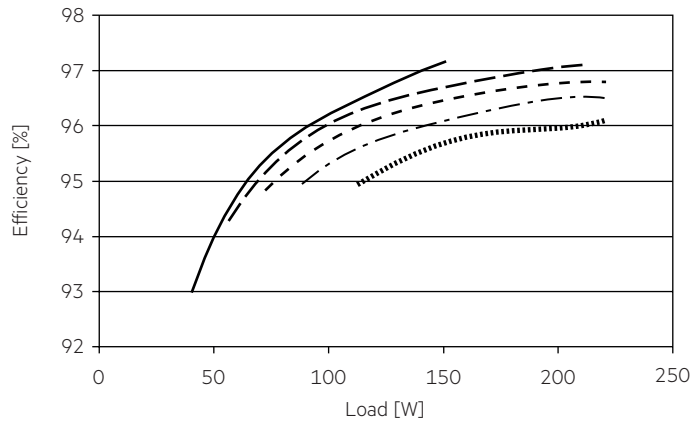

DALI bus power supply deactivated.

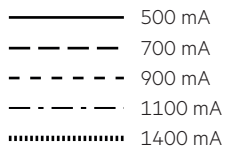

4.4 THD vs load (without harmonic < 5 mA or 0.6 % of the input current)

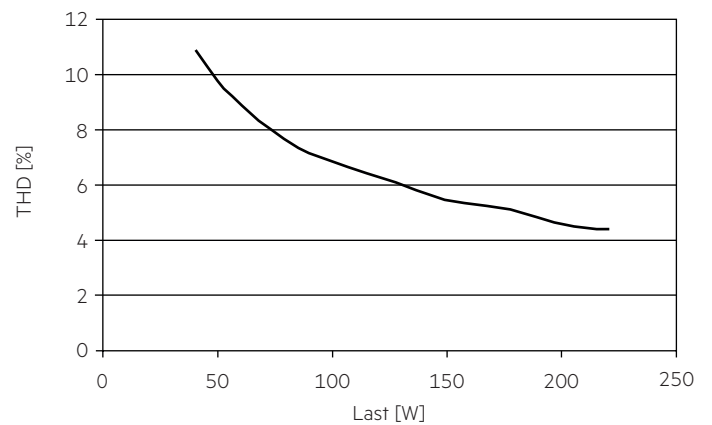

100 % load corresponds to the max. output power (full load) according to the table on page 2.

4.5 Maximum loading of automatic circuit breakers

Automatic circuit breaker type	C10	C13	C16	C20	B10	B13	B16	B20	Inrush current
Installation Ø	1.5 mm ²	1.5 mm ²	2.5 mm ²	4 mm ²	1.5 mm ²	1.5 mm ²	2.5 mm ²	4 mm ²	I_{max} time
LCI 220/500-1400/500 pD NF h28 PRE4	13	16	19	22	9	11	13	15	25 A 210 µs

These are max. values! Please consider not to exceed the maximum current of the circuit breaker.

Calculation uses typical values from ABB series S200 as a reference.

Actual values may differ due to used circuit breaker types and installation environment.

4.6 Harmonic distortion in the mains supply (at 230 V / 50 Hz and full load) in %

	THD	3.	5.	7.	9.	11.
LCI 220/500-1400/500 pD NF h28 PRE4	< 5	< 4	< 2	< 1	< 2	< 2

Acc. to 61000-3-2. Harmonics < 5 mA or < 0.6 % (whatever is greater) of the input current are not considered for calculation of THD.

4.7 Dimming

Dimming range 1% to 100 %

Digital control with:

- DSI signal: 8 bit Manchester Code
Speed 1% to 100% in 1.4 s
 - DALI signal: 16 bit Manchester Code
Speed 1% to 100% in 0.2 s
- Programmable parameter:
- Minimum dimming level
 - Maximum dimming level
 - Default minimum = 1%
 - Programmable range $1\% \leq \text{MIN} \leq 100\%$
 - Default maximum = 100%
 - Programmable range $100\% \geq \text{MAX} \geq 1\%$

Dimming curve is adapted to the eye sensitiveness.
Dimming is realized by amplitude dimming.

4.8 Dimming characteristics

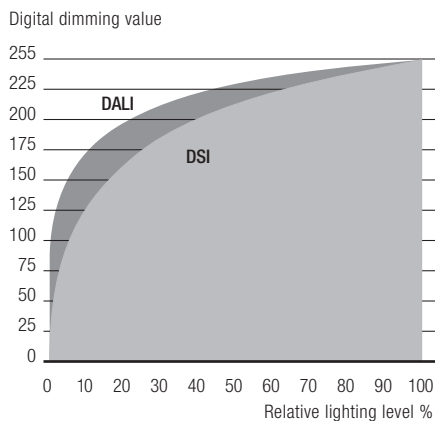

Dimming characteristics as seen by the human eye

5. Software / Programming / Interfaces

5.1 Software / programming

With appropriate software and interface different functions can be activated and various parameters can be configured in the LED driver. The Driver supports the following software and interfaces:

Software / hardware for configuration:

- companionSUITE (deviceGENERATOR, deviceCONFIGURATOR, deviceANALYSER)
- masterCONFIGURATOR

Interfaces for data transfer:

- NFC
- Control input DALI

5.2 Nearfield communication (NFC)

The NFC Interface allows wireless communication with the LED driver. This interface offers the option to write configuration and to read configuration, errors and events with the companionSUITE. A correct communication between the LED driver and the NFC antenna can only be guaranteed if the antenna is placed directly on the Driver. Any material placed between the LED driver and the NFC antenna can cause a deterioration of the communication quality. After programming the device via NFC power up the device one time for one second till the deviceANALYSER can read out the parameters. We recommend the use of following NFC antenna:
www.tridonic.com/nfc-readers

NFC is complied with ISO/IEC 15963 standard.

5.3 Control input DALI

The control input is non-polar for digital control signals (DALI). The control signal is not SELV. The control cable has to be installed in accordance to the requirements of low voltage installations.

Digital control with:

- DALI signal: 16 bit
- DSI signal: 8 bit

When using the internal DALI power supply as a closed system it is SELV. For example if only one sensor is attached.

5.4 switchDIM

Integrated switchDIM function allows a direct connection of a pushbutton for dimming and switching.

Brief push (< 0.6 s) switches LED driver ON and OFF. The dimm level is saved at power-down and restored at power-up.

When the pushbutton is held, LED modules are dimmed. After repush the LED modules are dimmed in the opposite direction.

In installations with LED drivers with different dimming levels or opposite dimming directions (e.g. after a system extension), all LED drivers can be synchronized to 50% dimming level by a 10 s push.

Use of pushbutton with indicator lamp is not permitted.

6. Functions

 companionSUITE:



























































DALI-USB, NFC

The companionSUITE with deviceGENERATOR, deviceCONFIGURATOR and deviceANALYSER is available via our WEB page:
<https://www.tridonic.com/com/en/products/companionsuite.asp>

 masterCONFIGURATOR:

DALI-USB

The masterCONFIGURATOR is available via our WEB page:
<https://www.tridonic.com/com/en/software-masterconfigurator.asp>

Icon	Function	NFC	DALI-2
	OEM Identification		 -
	OEM GTIN		 -
	Luminaire data		 -
	LED current		 
	Device operating mode		 
	switchDIM		 
	corridorFUNCTION		 
	Constant light output (eCLO)		 
	DC level		 
	Enhanced power on level (ePOL)		 
	DALI default parameters		 
	Scenes and groups		 
	fade2zero		 
	Power-up fading		 
	deviceKEY		 -
	Intelligent voltage guard (IVG)		 
	Dimming curve		 
	Factory reset		 -

6.1 OEM Identification



The OEM (Original Equipment Manufacturer) can set his own identification number.

DALI Part 251: Memory bank 1 extension.

6.2 OEM GTIN



The Original Equipment Manufacturer (OEM) can set his own Global Trade Item Number (GTIN).

DALI Part 251: Memory bank 1 extension.

6.3 Luminaire data



This function provides the asset management with accurate data about the luminaire.

DALI Part 251: Memory bank 1 extension.

DALI Part 253: Luminaire maintenance data.

6.4 LED current



The LED output current must be adapted to the connected LED module. The value is limited by the current range of the respective device.

The output current of the LED driver can be adjusted in a certain range. For adjustment there are 2 options available.

Option 1: DALI

Adjustment is done by companionSUITE or by masterCONFIGURATOR.

Option 2: NFC

Adjustment is done by companionSUITE via NFC.

6.5 Device operating mode



A Tridonic Driver supports several control signals.

These control signals are automatically detected and the mode is adapted.

If only one special device mode is required, this mode can be selected.

“Automatic detection” is the default setting.

6.6 switchDIM



Integrated switchDIM function allows a direct connection of a pushbutton for dimming and switching.

Brief push (< 0.6 s) switches LED driver ON and OFF. The dimm level is saved at power-down and restored at power-up. When the pushbutton is held, LED modules are dimmed. After repush the LED modules are dimmed in the opposite direction.

In installations with LED drivers with different dimming levels or opposite dimming directions (e.g. after a system extension), all LED drivers can be synchronized to 50% dimming level by a 10 s push.

Use of pushbutton with indicator lamp is not permitted.

6.7 corridorFUNCTION



With the corridorFUNCTION and a commercially available motion detector, it is easy to adapt the lighting in one area to its use.

That is, when the area is entered by a person, the lighting dims instantly to the desired brightness and is available in full strength.

After the area is left by the person, the brightness dims slowly to a smaller value or switches off completely.

The individual parameters of the desired profile, such as brightness values or delay times, can be adjusted flexibly and individually.

6.8 Enhanced Constant Light Output (eCLO)



With this function the light output of the LED module can be kept equal over the lifetime.

The light output of an LED module reduces over the course of its lifetime.

The Constant Light Output (eCLO) function compensates for this natural decline by constantly increasing the output current of the LED driver throughout its lifetime.

Enhanced eCLO shall be achieved by limitation of the LED current at the commissioning of the LED driver and providing a linear interpolation of the current over the time, depending on the data points given by the user.

The user has to insert up to eight pairs of data (time, level).

The output curve is the result of connecting the user data points linear.

Detailed description for eCLO see product manual.

The minimal CLO starting point is limited by the smallest output current of the LED driver.

6.9 DC operation



In emergency light systems with a central battery supply the DC recognition function uses the input voltage to detect if emergency mode is present. The LED driver then automatically switches to DC mode and dims the light to the defined DC level.

Without DC recognition different and more complex solutions would have to be applied in order to detect emergency mode.

DC recognition is integrated in the device as standard.

No additional commissioning is necessary for activation.



This is a safety-relevant parameter.
The setting is relevant for the dimensioning of the central battery system.

The LED driver is designed to operate on DC voltage and pulsed DC voltage. For a reliable operation, make sure that also in DC emergency operation the LED driver is run within the specified conditions as stated in chapter "4.1 operating window".

Light output level in DC operation: programmable 1 – 100 %
(factory default = 15 %, EOF_i = 0.13).

The voltage-dependent input current of Driver incl. LED module is depending on the used load.

The voltage-dependent no-load current of Driver (without or defect LED module and DALI bus power supply deactivated) is for:

AC: < 83.5 mA

DC: < 1.4 mA

In DC operation dimming mode can be activated.

If Dimming on DC is activated the requirements of the DC recognition function are ignored.

Even if DC is detected, the LED driver continues to behave as in AC mode

- The present dimming level is retained
- An emergency light level defined for the DC recognition function (DC level) is ignored
- Control signals via DALI continue to be executed

If Dimming on DC is activated then emergency mode is not recognised. The device no longer automatically switches to the emergency light level.

6.10 Enhanced power on level (ePOL)



The Enhanced Power On Level parameter defines the power level that is set automatically when power is restored after a power failure.

The Enhanced Power On Level can be set to a fixed value (0 – 100 %) or can recall the memory value.

The memory value is the last value the LED driver was set to before the power failure.

This value applies not only in DALI device operating mode, but also in the device operating mode switchDIM.

6.11 Energy reporting



This function complies to DiiA specification DALI Part 252 - Energy reporting. It provides the information related to energy reporting accessible through memory banks in this driver. Several functions and values could be read out to gain access in Content management systems.

Report and values for Active power, Active Energy and many more can be read out.

6.12 Diagnostics and maintenance



This function complies to DiiA specification DALI Part 253 - Diagnostics and maintenance. It provides the information related to diagnostics and maintenance information accessible through memory banks. Several functions and values could be read out to gain access in Content management systems.

Report and values for failure behaviour, driver conditions and malfunctions trigger points can be read out.

6.13 Integrated DALI bus power supply



This function complies to DiiA specification DALI Part 250 - Integrated bus power supply.

The output power of the integrated DALI Bus Power Supply (pDALI) has an output current of 50 mA (max. 62.5 mA).

It is activated by factory default.

Sensors and also external drivers could be directly connected to this power supply. The DALI power supply could be deactivated via software.



Power supplies can be combined up to 250 mA max in total. This maximum must not exceed. The polarity has to be considered.

If the DALI power supply is activated, the driver must not be integrated into an existing, already with 250 mA powered DALI network.



DALI bus power supply has to be deactivated when using switchDIM or corridorFUNCTION. Otherwise it could be damaged.

6.14 DALI default parameters

DALI-2

In order for all luminaires to react the same for each operation (switching, dimming, scene recall ...), these values must be set the same. These DALI standard parameters are supported by every DALI-2 device.

6.15 Scenes and groups



Each device can be a member of up to 16 groups. Also, 16 different scene values can be stored in each device.

6.16 fade2zero



When the Driver is switched off, fade2zero allows a smooth dimming down to almost zero.

Activate the fade2zero function when programming with companionSUITE and set a DALI fade time. fade2zero only works if the minimum dimming level of the Driver is the default value.

The device then dims to far below the limit of its working window (dimming range).

This function is deactivated by default.

6.17 Power-up fading



The power-up function offers the opportunity to modify the on behavior. The time for fading on can be adjusted in a range of 0.2 to 16 seconds. According to this value, the device dims from 0 % up to the power-on level. By factory default no fading time is set (= 0 seconds).

6.18 Dimming curve



DALI:
The desired dimming behaviour is selected via two different dimming curves (logarithmic or linear).
The default setting of the dimming behaviour is logarithmic.

7. Protective features

7.1 Intelligent temperature guard (ITG)



The Intelligent temperature guard (ITG) function provides effective protection against thermal overloads by slowly reducing the output if a defined internal temperature is exceeded.

The reduction of overtemperatures takes place in small steps every two minutes. As soon as the temperature drops again, the output power is gradually increased every 10 minutes.

On DC operation this function is deactivated to fulfill emergency requirements.

7.2 Intelligent Voltage Guard (IVG)



Intelligent Voltage Guard is the name of the electronic monitoring of the mains voltage. It immediately shows if the mains voltage rises above certain thresholds. Measures can then be taken quickly to prevent damage to the LED driver.

- If the mains voltage rises above approx. 280 Vrms (voltage depends on the LED driver type), the LED light starts flashing on and off.
- To avoid a damage of the LED driver the mains supply has to be switched off at this signal.

7.3 Short-circuit behaviour

In case of a short-circuit at the LED output the LED output is switched off. After restart of the LED driver the output will be activated again. The restart can either be done via mains reset or via interface (DALI, DSI, switchDIM)

7.4 No-load operation

The LED driver will not be damaged in no-load operation. The output will be deactivated and is therefore free of voltage. If a LED load is connected the device has to be restarted before the output will be activated again.

7.5 Overload protection

If the maximum load is exceeded by a defined internal limit, the LED driver turns off the LED output. After restart of the LED driver the output will be activated again.

The restart can either be done via mains reset or via interface (DALI, DSI, switchDIM).

7.6 Insulation between terminals

Insulation	Mains	PE	LED	DALI
Mains	–	basic	–	double
PE	basic	–	basic	basic
LED	–	basic	–	double
DALI	double	basic	double	–

basic ... represents basic insulation.

double ... represents double or reinforced insulation.

8. Extended industry standard

The devices of the industrial series are tested with various tests. For the special industrial sector additional extended tests are carried out. A special test method (see EN 60068-2-27 (shock – test case: 1,000 shocks in 6 directions with 30 g / 18 ms) and EN 60068-2-64 (vibration – test case: acc. to table A.1 transport / category 2)) ensures operation in extreme environmental conditions. This robustness is also achieved by the selection of special exclusive components.

9. Miscellaneous

9.1 Insulation and electric strength testing of luminaires

Electronic devices can be damaged by high voltage. This has to be considered during the routine testing of the luminaires in production.

According to IEC 60598-1 Annex Q (informative only!) or ENEC 303-Annex A, each luminaire should be submitted to an insulation test with 500 V_{DC} for 1 second. This test voltage should be connected between the interconnected phase and neutral terminals and the earth terminal. The insulation resistance must be at least 2 MΩ.

As an alternative, IEC 60598-1 Annex Q describes a test of the electrical strength with 1500 V_{AC} (or 1.414 x 1500 V_{DC}). To avoid damage to the electronic devices this test must not be conducted.

9.2 Conditions of use and storage

Humidity: 5% up to max. 85%,
not condensed
(max. 56 days/year at 85%)

Storage temperature: -40 °C up to max. +80 °C

The devices have to be acclimatised to the specified temperature range (ta) before they can be operated.

The LED driver is declared as inbuilt LED controlgear, meaning it is intended to be used within a luminaire enclosure. If the product is used outside a luminaire, the installation must provide suitable protection for people and environment (e.g. in illuminated ceilings).

9.3 Maximum number of switching cycles

All LED driver are tested with 50,000 switching cycles. The actually achieved number of switching cycles is significantly higher.

9.4 Additional information

Additional technical information at www.tridonic.com → Technical Data

Lifetime declarations are informative and represent no warranty claim. No warranty if device was opened.