



Driver LC 20W 100–1050mA 44V NF SR EXC3
excite series

Product description

- Independent constant current LED driver
- Output current adjustable between 100 – 1,050 mA with NFC
- Max. output power 20 W
- Up to 81 % efficiency
- Nominal lifetime up to 100,000 h
- 5 years guarantee (conditions at www.tridonic.com)

Housing properties

- Casing: polycarbonate, white
- Type of protection IP20
- Toolless mounting of strain relief

Interfaces

- Near field communication (NFC)

Functions

- Adjustable output current in 1-mA-steps (NFC)
- Protective features (overtemperature, short-circuit, overload, no-load)
- Surge protection voltage 1 kV (L – N)
- Suitable for emergency escape lighting systems acc. to EN 50172
- For cable cross-sections up to 2.5 mm²

Benefits

- Flexible configuration via companionSUITE (NFC)
- Application-oriented operating window for maximum compatibility
- New strain relief concept – fast mounting and pre-assembled connection of the LED load possible

Typical applications

- For applications in downlight and decorative luminaires



Standards, page 4

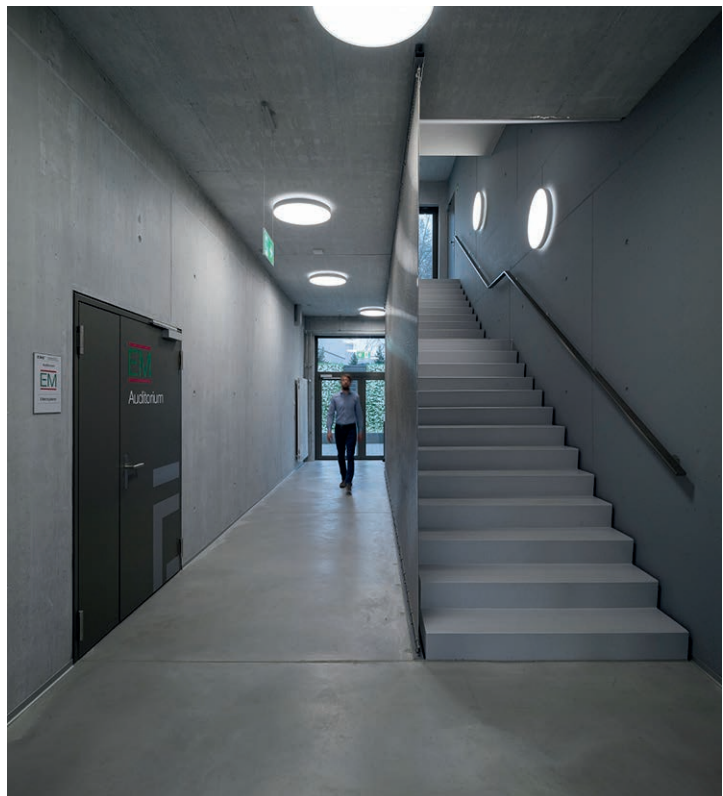
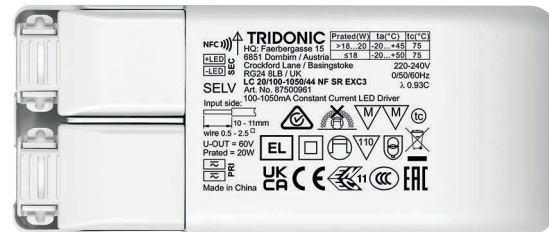

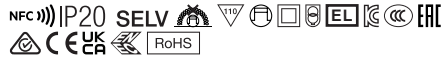

Driver LC 20W 100–1050mA 44V NF SR EXC3

excite series

Technical data

Rated supply voltage	220 – 240 V
AC voltage range	198 – 264 V
DC voltage range	176 – 270 V
Mains frequency	0 / 50 / 60 Hz
Overvoltage protection	320 V AC, 48 h
Typ. current (at 230 V, 50 Hz, full load) ^① ②	111 mA
Typ. current (220 V, 0 Hz, full load, 100 % dimming level) ^②	110 mA
Leakage current (at 230 V, 50 Hz, full load) ^① ②	< 700 µA
Max. input power	24.5 W
Typ. efficiency (at 230 V / 50 Hz / full load) ^②	81 %
λ (at 230 V, 50 Hz, full load) ^①	0.93C
Typ. input current in no-load operation	< 21 mA
Typ. input power in no-load operation	0.995 W
In-rush current (peak / duration)	4.3 A / 32 µs
THD (at 230 V, 50 Hz, full load) ^①	< 20 %
Starting time (at 230 V, 50 Hz, full load) ^①	< 0.5 s
Starting time (DC mode)	< 0.8 s
Switchover time (AC/DC) ^②	< 1 s
Turn off time (at 230 V, 50 Hz, full load)	< 0.2 s
Output current tolerance ^① ③ ④	± 5 %
Max. output current peak (non-repetitive) ^⑤	≤ Output current + 20 %
Output LF current ripple (< 120 Hz)	± 5 %
Output P_{stLM} (at full load)	≤ 1
Output SVM (at full load)	≤ 0.4
Max. output voltage (U-OUT)	60 V
Mains surge capability (between L – N)	1 kV
Mains surge capability (between L/N – PE)	2 kV
Surge voltage at output side (against PE)	3 kV
Type of protection	IP20
Lifetime	up to 100,000 h
Guarantee (conditions at www.tridonic.com)	5 years
Dimensions L x W x H	120 x 51 x 29.2 mm

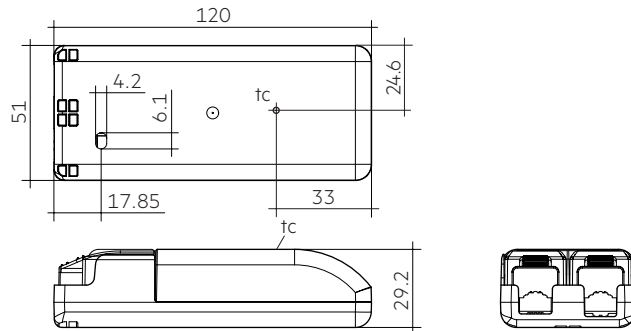

Ordering data

Type	Article number	Packaging carton	Packaging low volume	Packaging high volume	Weight per pc.
LC 20/100-1050/44 NF SR EXC3	87500961	10 pc(s).	130 pc(s).	2,080 pc(s).	0.103 kg

Specific technical data

Type	Output current ^①	Min. forward voltage	Max. forward voltage	Max. output power	Typ. power consumption (at 230 V, 50 Hz, full load)	Typ. current consumption (at 230 V, 50 Hz, full load)	Max. casing temperature tc	Ambient temperature ta max.
Max. output power ≤ 18 W								
LC 20/100-1050/44 NF SR EXC3	100 mA	15.0 V	44.0 V	4.4 W	6.7 W	43 mA	70 °C	-20 ... +50 °C
	200 mA	7.5 V	44.0 V	8.8 W	11.2 W	60 mA	70 °C	-20 ... +50 °C
	300 mA	7.0 V	44.0 V	13.2 W	15.9 W	78 mA	70 °C	-20 ... +50 °C
	400 mA	7.0 V	44.0 V	17.6 W	20.8 W	97 mA	75 °C	-20 ... +50 °C
	500 mA	7.0 V	36.0 V	18.0 W	23.6 W	107 mA	75 °C	-20 ... +50 °C
	600 mA	7.0 V	30.2 V	18.1 W	21.7 W	101 mA	75 °C	-20 ... +50 °C
	700 mA	7.0 V	25.8 V	18.1 W	21.8 W	102 mA	75 °C	-20 ... +50 °C
	800 mA	7.0 V	22.6 V	18.1 W	22.1 W	103 mA	75 °C	-20 ... +50 °C
	900 mA	7.0 V	20.0 V	18.1 W	22.4 W	104 mA	75 °C	-20 ... +50 °C
	1050 mA	7.0 V	17.1 V	18.0 W	22.5 W	104 mA	75 °C	-20 ... +50 °C
Max. output power > 18 W								
LC 20/100-1050/44 NF SR EXC3	500 mA	36.0 V	40.0 V	20.0 W	23.5 W	107 mA	75 °C	-20 ... +45 °C
	600 mA	30.2 V	33.4 V	20.0 W	23.6 W	108 mA	75 °C	-20 ... +45 °C
	700 mA	25.8 V	28.5 V	20.0 W	24.0 W	109 mA	75 °C	-20 ... +45 °C
	800 mA	22.6 V	25.0 V	20.0 W	24.2 W	110 mA	75 °C	-20 ... +45 °C
	900 mA	20.0 V	22.2 V	20.0 W	24.5 W	111 mA	75 °C	-20 ... +45 °C
	1050 mA	17.1 V	19.0 V	20.0 W	24.5 W	111 mA	75 °C	-20 ... +45 °C

① Valid at 100 % dimming level.

② Depending on the selected output current.

③ Output current is mean value.

④ Valid for immediate change of power supply type otherwise the starting time is valid.

⑤ For output current range 100 – 250 mA, max. output current peak (non-repetitive) ≤ 250 mA.

⑥ For ≥ 5 W load the output current tolerance is ± 5%, for < 5 W it is ± 10%.

1. Standards

EN 55015
 EN 61000-3-2
 EN 61000-3-3
 EN 61000-4-4
 EN 61000-4-5
 EN 61347-1
 EN 61347-2-13
 EN 62384
 EN 61547
 EN 60598-1
 According to EN 50172 for use in central battery systems
 According to EN 60598-2-22 suitable for emergency lighting installations

2. Thermal details and lifetime

2.1 Expected lifetime

Expected lifetime					
Type	Load range	ta	40 °C	45 °C	50 °C
LC 20/100-1050/44 NF SR EXC3	≤ 18 W	tc	65 °C	70 °C	75 °C
		Lifetime	> 100,000 h	75,000 h	50,000 h
	> 18 – 20 W	tc	70 °C	75 °C	X
		Lifetime	75,000 h	50,000 h	X

The LED driver is designed for a lifetime stated above under reference conditions and with a failure probability of less than 10 %.

The relation of tc to ta temperature depends also on the luminaire design.
 If the measured tc temperature is approx. 5 K below tc max., ta temperature should be checked and eventually critical components (e.g. ELCAP) measured. Detailed information on request.

3. Installation / wiring

3.1 Circuit diagram

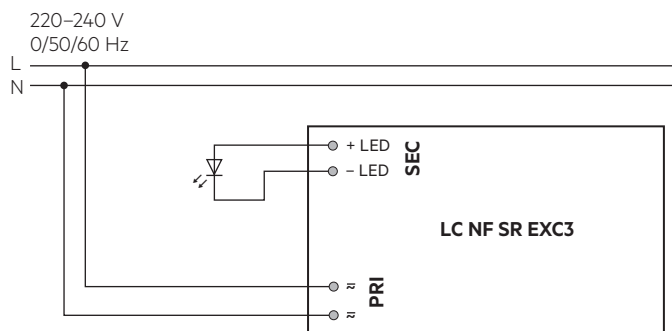

Secondary wires (LED module)

The wiring can be in stranded wires with ferrules or solid with a cross section of 0.5–1.5 mm².
 Strip 8.5–9.5 mm of insulation from the cables to ensure perfect operation of the push-wire terminals.
 Use one wire for each terminal connector only.
 Use each strain relief channel for one cable only.

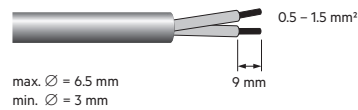

3.2 Wiring type and cross section

Mains supply wires

Stranded wire or solid wire from 0.5 to 2.5 mm² may be used for wiring.
 Strip 10–11 mm of insulation from the cables to ensure perfect operation of the push terminals.
 Use one wire for each terminal connector only.
 Use each strain relief channel for one cable only.

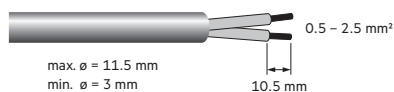

Cable type EC53 2x0.5 mm² possible with mounting force of > 180 N.

3.3 Loose wiring

Supply/DALI

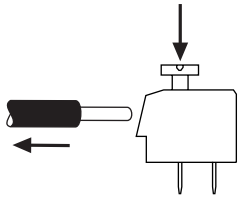

LED module

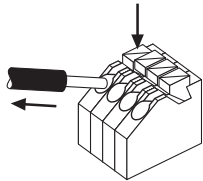

Press down the "push button" and remove the cable from front.

3.4 Mounting of strain relief

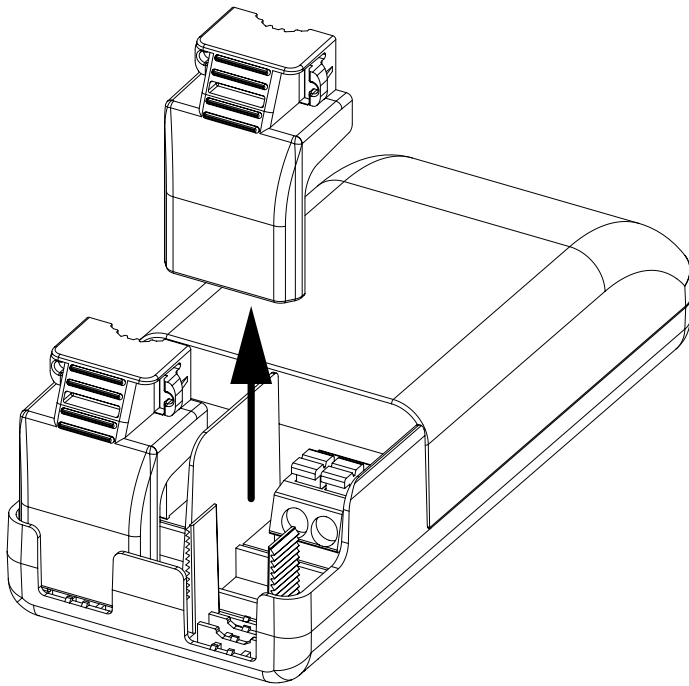

1. Loose strain relief elements from delivery position
2. Wiring the device
3. Push on strain relief element

3.5 Releasing the strain relief

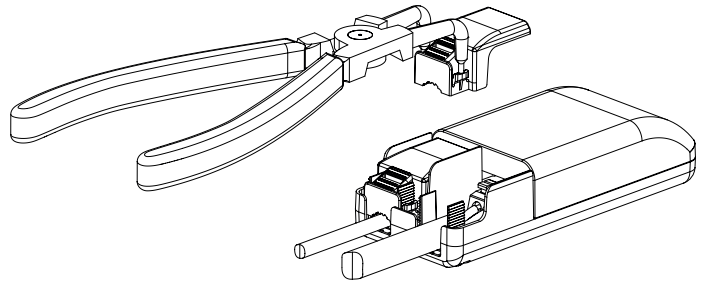

1. Insert release tool device into cut-out, e.g. KNIPEX 46 21 A21 Seeger ring pliers or screwdriver
2. Remove strain relief element

3.6 Fixing conditions

Dry, acidfree, oilfree, fatfree. It is not allowed to exceed the maximum ambient temperature (t_a) stated on the device. Minimum distances stated below are recommendations and depend on the actual luminaire. Device is not suitable for fixing in corner.

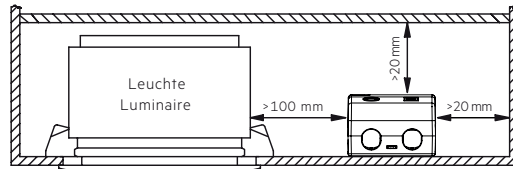

3.7 Wiring guidelines

- Run the secondary lines separately from the mains connections and lines to achieve good EMC performance.
- The max. secondary cable length is 2 m (4 m circuit).
- For good EMC performance, keep the LED wiring as short as possible.
- To comply with the EMC regulations run the secondary wires (LED module) in parallel.
- Secondary switching is not permitted.
- The LED driver has no inverse-polarity protection on the secondary side. Wrong polarity can damage LED modules with no inverse-polarity protection.
- Wrong wiring of the LED driver can lead to malfunction or irreparable damage.
- To avoid the damage of the Driver, the wiring must be protected against short circuits to earth (sharp edged metal parts, metal cable clips, louver, etc.).

3.8 Replace LED module

1. Mains off
2. Remove LED module
3. Wait for 10 seconds
4. Connect LED module again

Hot plug-in or secondary switching of LEDs is not permitted and may cause a very high current to the LEDs.

3.9 Installation note

Max. torque at the clamping screw: 0.5 Nm / M4

4. Electrical values

4.1 Operating window

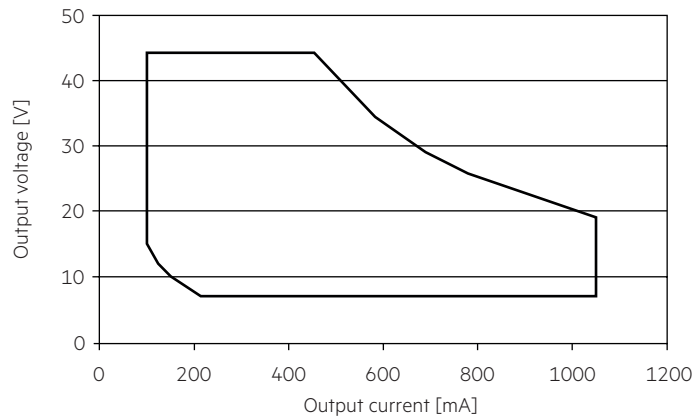

Make sure that the LED driver is operated within the given window under all operating conditions.

4.2 Efficiency vs load

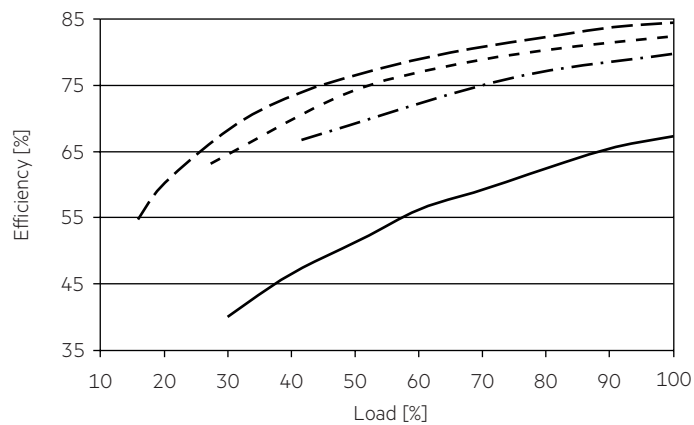

4.3 Power factor vs load

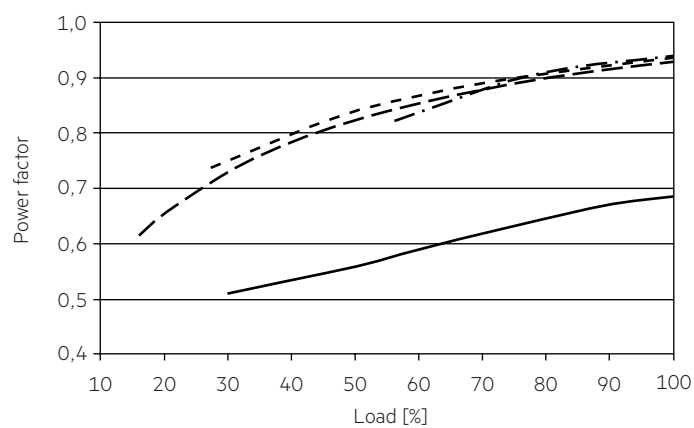

4.4 Input power vs load

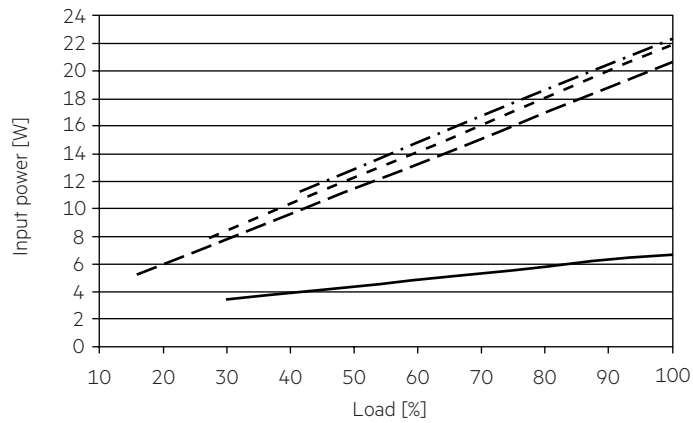

4.5 Input current vs load

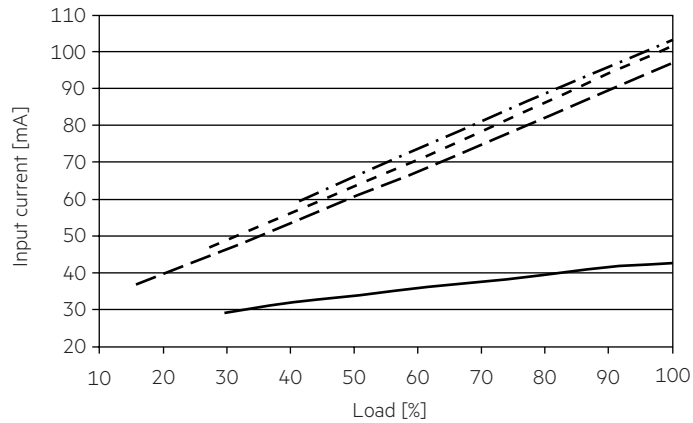

4.6 THD vs load

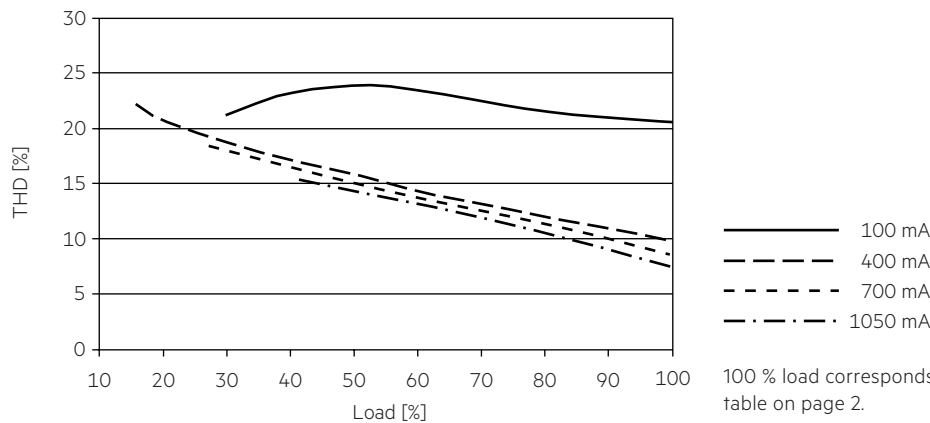

100 % load corresponds to the max. output power (full load) according to the table on page 2.

4.7 Maximum loading of automatic circuit breakers in relation to inrush current

Automatic circuit breaker type	C10	C13	C16	C20	B10	B13	B16	B20	Inrush current	
Installation Ø	1.5 mm ²	1.5 mm ²	2.5 mm ²	2.5 mm ²	1.5 mm ²	1.5 mm ²	2.5 mm ²	2.5 mm ²	I_{max}	time
LC 20/100-1050/44 NF SR EXC3	70	91	112	140	70	91	112	140	4.3 A	32 µs

These are max. values calculated out of continuous current running the device on full load. There is no limitation due to inrush current. If load is smaller than full load for calculation only continuous current has to be considered.

**4.8 Harmonic distortion in the mains supply (at 230 V / 50 Hz and full load)
in %**

	THD	3.	5.	7.	9.	11.
LC 20/100-1050/44 NF SR EXC3	< 10	< 10	< 8	< 6	< 5	< 3

4.9 Insulation matrix

	Mains	Output
Mains	–	••
Output	••	–

•• Represents double insulation

5. Software / Programming / Interfaces

5.1 Software / programming

With appropriate software and interface different functions can be activated and various parameters can be configured in the LED driver. The Driver supports the following software and interfaces:

Software / hardware for configuration:

- companionSUITE (deviceGENERATOR, deviceCONFIGURATOR, deviceANALYSER)

Interfaces for data transfer:

- NFC

5.2 Nearfield communication (NFC)

The NFC Interface allows wireless communication with the LED driver. This interface offers the option to write configuration and to read configuration, errors and events with the companionSUITE. A correct communication between the LED driver and the NFC antenna can only be guaranteed if the antenna is placed directly on the Driver. Any material placed between the LED driver and the NFC antenna can cause a deterioration of the communication quality. After programming the device via NFC power up the device one time for one second till the deviceANALYSER can read out the parameters. We recommend the use of following NFC antenna: www.tridonic.com/nfc-readers







NFC is complied with ISO/IEC 15963 standard.

6. Functions

☉ companionSUITE:

NFC

The companionSUITE with deviceGENERATOR, deviceCONFIGURATOR and deviceANALYSER is available via our WEB page:
<https://www.tridonic.com/com/en/products/companionsuite.asp>

Icon	Function	NFC
	Device reset command	☉
	Constant light output (CLO)	☉
	DC Level	☉
	LED current	☉
	OEM Identification	☉
	OEM GTIN	☉
	Luminaire data	☉

6.1 LED current



The LED output current must be adapted to the connected LED module.
The value is limited by the current range of the respective device.

The priority for current adjustment methods is NFC / DALI (highest priority).

Minimum output current is default.

6.2 Light level in DC operation



The LED driver is designed to operate on DC voltage and pulsed DC voltage.
For a reliable operation, make sure that also in DC emergency operation the LED driver is run within the specified conditions as stated in chapter "4.1 operating window".

Light output level in DC operation is programmable (50 – 100 %).
Default value is 100 % (EOFi = 0.95).

The voltage-dependent input current of Driver incl. LED module is depending on the used load.

The voltage-dependent no-load current of Driver (without or defect LED module) is for:

AC: < 21 mA

DC: < 4.2 mA

7. Protective features

7.1 Short-circuit behaviour

In case of a short-circuit at the LED output the LED output is switched off. After elimination of the short-circuit fault the LED driver need to restart.

7.2 No-load operation

The LED driver will not be damaged in no-load operation. The output will be deactivated and is therefore free of voltage. If a LED load is connected the device has to be restarted before the output will be activated again.

7.3 Overload protection

If the maximum load is exceeded by a defined internal limit, the LED driver will protect itself and LED may flicker. After elimination of the overload, the nominal operation is restored automatically.

7.4 Overtemperature protection

The LED driver is protected against temporary thermal overheating. If the temperature limit is exceeded the LED driver will switch off. It restarts automatically. The temperature protection is activated typically at 10 °C above $t_{c\ max}$.

7.5 Insulation

The LED driver is double insulated.

8. Miscellaneous

8.1 Insulation and electric strength testing of luminaires

Electronic devices can be damaged by high voltage. This has to be considered during the routine testing of the luminaires in production.

According to IEC 60598-1 Annex Q (informative only!) or ENEC 303-Annex A, each luminaire should be submitted to an insulation test with 500 V_{DC} for 1 second. This test voltage should be connected between the interconnected phase and neutral terminals and the earth terminal. The insulation resistance must be at least 2 MΩ.

As an alternative, IEC 60598-1 Annex Q describes a test of the electrical strength with 1500 V_{AC} (or 1.414 x 1500 V_{DC}). To avoid damage to the electronic devices this test must not be conducted.

8.2 Conditions of use and storage

Humidity: 5 % up to max. 85 %,
not condensed
(max. 56 days/year at 85 %)

Storage temperature: -40 °C up to max. +80 °C

The devices have to be acclimatised to the specified temperature range (t_a) before they can be operated.

The LED driver is declared as inbuilt LED controlgear, meaning it is intended to be used within a luminaire enclosure.

If the product is used outside a luminaire, the installation must provide suitable protection for people and environment (e.g. in illuminated ceilings).

8.3 Additional information

Additional technical information at www.tridonic.com → Technical Data

Lifetime declarations are informative and represent no warranty claim. No warranty if device was opened.