



# TeSys Control

TeSys K, Deca, Giga S207 series  
Contactors for railway applications  
Catalogue 2022





# TeSys Control

## TeSys K, TeSys Deca and TeSys Giga contactors

Introduction



## TeSys K, TeSys Deca and TeSys Giga contactors: S207 series for railway applications





# TeSys Control

## TeSys K, TeSys Deca and TeSys Giga contactors

### Introduction



> Used in heating, lighting, door control, signaling, brake and air conditioning compressors, TeSys K, TeSys Deca and TeSys Giga\* S207 series contactors are designed for railway power switching and controlling applications, while complying with the railway European standard EN 45545 R22 HL3.

\*: HL2 for TeSys Giga.

> Schneider Electric load control solutions in the move

TeSys Deca S207, possible association with other EN 45545 R22 HL2 compliant TeSys components



GV2P  
thermal magnetic  
circuit breaker



LRD thermal  
overload  
relay

# TeSys Control

## TeSys K, TeSys Deca and TeSys Giga contactors

### Introduction



## TeSys K, TeSys Deca and TeSys Giga contactors: S207 series compliant with railway standards



### Shocks, vibrations requirements, according to IEC/EN 61373 standard tests

- Category 1: body mounted
- Class B: cubicles, subassemblies, equipment and components mounted directly on or under the car body.



### Fire, smoke requirements, according to EN 45545-2 Part 2, DIN 5510-2



### European standard EN 45545-2

Newly published in 2020, specifies the reaction to fire performance requirements for materials and products used on railway vehicles as defined in EN 45545-1, and applies to all countries in Europe.

For each hazard level, this standard specifies the material and products test methods, test conditions and reaction to fire performance requirements.



# TeSys Control

## TeSys K, TeSys Deca and TeSys Giga contactors

### Contents

TeSys Control	
	Page
Presentation	
TeSys K S207 series - AC-3: up to 12 A	6
TeSys Deca S207 series - AC-3: up to 95 A	7
TeSys Giga S207 series - AC-3: up to 800 A	8
References	
TeSys K S207 series	9
TeSys Deca S207 series	10
TeSys Giga S207 series	12
Technical Data for Designers 15	
TeSys K S207 series	
Characteristics	16
Dimensions and schemes	20
TeSys Deca S207 series	
Characteristics	21
Dimensions and schemes	25
TeSys Giga S207 series	
Characteristics	27
Dimensions and schemes	32

# TeSys Control

## TeSys K S207 - Contactors for railway applications

### Introduction

PB12304.tif



### TeSys K - S207 series

New range of EN 45545 R22 HL3 compliant mini contactors:

- Width: 45 mm
- Height: 58 mm
- Depth: 57 mm
- Weight: 0.235 kg.

Contactor types, covered applications:

- AC-3, up to 12 Amps
- AC-1, up to 20 Amps
- Control circuits, up to 10 Amps.

Simple, robust, and compact,  
**TeSys K is optimized**  
for common applications

Range of 33 contactors for motors (AC-3), resistive loads (AC-1), control circuits:

**3P, 4P contactors:**

- AC-3 ratings / 3 poles: 6, 9, 12 A
- AC-1 rating / 4 poles: 20 A
- 1 NO or 1 NC embedded auxiliary contact

**Contactors for control circuits:**

- 4 NO or 2 NO + 2 NC or 3 NO + 1 NC
- 10 A

**Common features:**

- Connection by lugs
- 24, 72, 110 V DC low consumption coils,
- Coil supply range: up to 0.7 to 1.3  $U_c$  from -40 °C to +70 °C.

> See TeSys K S207 contactor selection tables for available combinations of features.



# TeSys Control

## TeSys Deca S207 - Contactors for railway applications

### Introduction



### TeSys Deca - S207 series

Now made of new material,  
EN 45545 R22 HL3 compliant,  
with unchanged commercial reference.

Contactor types, covered applications:

- AC-3/AC-3e, up to 95 Amps
- AC-1, up to 125 Amps
- Control circuits, up to 10 Amps.

### TeSys Deca, the right choice for demanding or wide power range applications

Range of 139 contactors for motors (AC-3),  
resistive loads (AC-1), control circuits:

#### 3P, 4P contactors:

- AC-3/AC-3e ratings / 3 poles: 9, 12, 18, 25, 32, 38, 40, 50, 65, 80, 95 A
- AC-1 ratings / 4 poles: 20, 25, 32, 40, 60, 125 A
- 1 NO + 1 NC embedded auxiliary contact on all ratings (except on 60, 80, 125 A 4-pole contactors).

#### Contactors for control circuits:

- 5 NO or 3 NO + 2 NC
- 10 A

#### Common features:

- Connection by lugs
- 24, 72, 96, 110 V DC coils, standard, low consumption and wide range
- Coil supply range: up to 0.7 to 1.25 Uc.



GV2P



LRD

### EN 45545 R22 HL2 compliant motor starters

Up to 38 A AC-3/AC-3e, with TeSys Deca - S207  
associated to:

> GV2P thermal magnetic circuit breakers

Please refer to catalogue 'TeSys - Innovative and connected solutions for  
motor starters' for details.

# TeSys Control

## TeSys Giga S207 - Contactors for railway applications

### Introduction

PB123917.tif



NEW

### TeSys Giga - S207 series

Now made of new material,  
EN 45545 R22 HL2 compliant.

Contactor types, covered applications:

- AC-3, 115 A to 800 A
- AC-1, 250 A to 1050 A.

### TeSys Giga, the right choice for a wide range of demanding applications

Range of 20 contactor references for motors (AC-3),  
resistive loads (AC-1):

**3P, 4P contactors:**

- AC-3 ratings / 3 poles: 115, 150, 185, 225, 265, 330, 400, 500, 630, 800 A
- AC-1 ratings / 4 poles: 250, 275, 305, 330, 385, 440, 550, 700, 1050 A
- Equipped with 1 NO + 1 NC auxiliary contact block
- Embedded contact wear diagnostic feature

**Common features:**

- Connection by lugs & bars
- 48...130 V AC/DC wide range coil control
- Modular design enables faster & easy maintenance.



# TeSys Control

## TeSys K S207 - Contactors for railway applications

### Product references

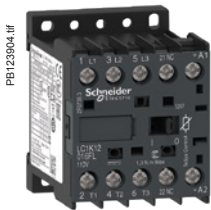

LC1K12016FLS207

3-pole contactors for Motor control - connection by lugs							Weight
Standard power ratings of 3-phase motors 50-60 Hz in category AC-3			Rated operational current in AC-3 440 V up to	Instantaneous auxiliary contacts		Commercial reference Replace dots by coil voltage code (see chart below)	kg
220 V	380 V	440/500 V					
230 V	415 V	660/690 V	A	1	–	LC1K06106●●S207	0.235
1.5	2.2	3	6	–	1	LC1K06016●●S207	0.235
2.2	4	4	9	1	–	LC1K09106●●S207	0.235
				–	1	LC1K09016●●S207	0.235
3	5.5	5.5 (≤ 440 V)	12	1	–	LC1K12106●●S207	0.235
		4 (≥ 480 V)		–	1	LC1K12016●●S207	0.235

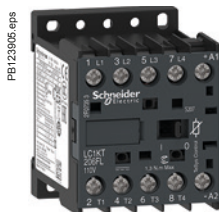

LC1KT206FLS207

4-pole contactors - connection by lugs						
Non inductive loads Category AC-1 Maximum current at (θ ≤ 50 °C)	Number of poles	Instantaneous auxiliary contacts		Commercial reference Replace dots by coil voltage code (see chart below)	kg	
A						
20	4	–	–	LC1KT206●●S207	0.235	
	2	2	–	LC1K0986●●S207	0.235	

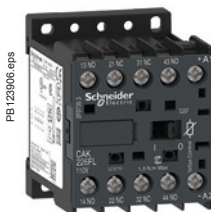

CAK226FLS207

4-pole contactors for Control circuit - connection by lugs						
Control circuit consumption	Auxiliary contacts	Instantaneous auxiliary contacts		Commercial reference Replace dots by coil voltage code (see chart below)	kg	
lth = 10 A						
	4	–	–	CAK406●●S207	0.235	
	3	1	–	CAK316●●S207	0.235	
	2	2	–	CAK226●●S207	0.235	

Low consumption coil voltage code						
Volts DC		24	72	110		
U 0.7 ..... 1.3 Uc		BL	SL	FL		



LA1KN11

Instantaneous auxiliary contact blocks <sup>(1)</sup>						
Recommended for standard applications, Clip-on front mounting, 1 block per contactor						
Connection	Composition	Instantaneous auxiliary contacts		Reference		
Screw clamp terminals	2	–	–	LA1KN20		
	–	2	–	LA1KN02		
	1	1	–	LA1KN11		
Lug terminals	2	2	–	LA1KN226		
	4	–	–	LA1KN406		

<sup>(1)</sup> Add on auxiliary contacts compliancy level to EN 45545 is R22 HL3.

# TeSys Control

## TeSys Deca S207 - Contactors for railway applications

### Product references



LC1D096FDS207



LC1D406FWS207



LC1D806FWS207



LC1DT206FDS207

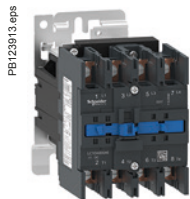

LC1D400046FWS207

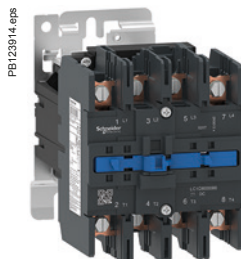

LC1D800086FWS207

### 3-pole contactors for Motor control - connection by lugs

Standard power ratings of 3-phase motors 50-60 Hz in category AC-3/AC-3e ( $\theta \leq 60^\circ\text{C}$ )							Rated operational current in AC-3/AC-3e 440 V up to	Instan- taneous auxiliary contacts	Commercial reference Replace dots by coil voltage code (see chart below)		Weight	
220 V	380 V	415 V	440 V	500 V	660 V	1000 V			coil with surge suppressor <sup>(1)</sup>	Coil without surge suppressor		
230 V	415 V				690 V		A			kg		
2.2	4	4	4	5.5	5.5	-	9	1	1	LC1D096●●S207	0.320	
3	5.5	5.5	5.5	7.5	7.5	-	12	1	1	LC1D126●●S207	0.325	
4	7.5	9	9	10	10	-	18	1	1	LC1D186●●S207	0.330	
5.5	11	11	11	15	15	-	25	1	1	LC1D256●●S207	0.370	
7.5	15	15	15	18.5	18.5	-	32	1	1	LC1D326●●S207	0.375	
9	18.5	18.5	18.5	18.5	18.5	-	38	1	1	LC1D386●●S207	0.380	
11	18.5	22	22	22	30	22	40	1	1	-	LC1D406●●S207	2.185
15	22	25	30	30	33	30	50	1	1	-	LC1D506●●S207	2.185
18.5	30	37	37	37	37	37	65	1	1	-	LC1D656●●S207	2.185
22	37	45	45	55	45	45	80	1	1	-	LC1D806●●S207	2.59
25	45	45	45	55	45	45	95	1	1	-	LC1D956●●S207	2.61

### 4-pole contactors for Resistive load control - connection by lugs

Non inductive loads maximum current ( $\theta \leq 60^\circ\text{C}$ ) utilisation category AC-1	Number of poles	Instan- taneous auxiliary contacts		Commercial reference Replace dots by coil voltage code (see chart below)		Weight
				coil with surge suppressor <sup>(1)</sup>	Coil without surge suppressor	
A						kg
20	4	-	1	1	LC1DT206●●S207	0.365
	2	2	1	1	LC1D0986●●S207	0.365
25	4	-	1	1	LC1DT256●●S207	0.365
	2	2	1	1	LC1D1286●●S207	0.365
32	4	-	1	1	LC1DT326●●S207	0.425
	2	2	1	1	LC1D1886●●S207	0.425
40	4	-	1	1	LC1DT406●●S207	0.425
	2	2	1	1	LC1D2586●●S207	0.425
60	4	-	-	-	LC1D400046●●S207	2.210
	2	2	-	-	LC1D400086●●S207	2.210
125	4	-	-	-	LC1D800046●●S207	2.685
	2	2	-	-	LC1D800086●●S207	2.910

<sup>(1)</sup> A suppressor diode (Transil TM) in parallel with the coil helps to prevent upstream sensitive components from damage by high transient voltage during the coil switching.

### Coil voltage codes

DC Volts	24	72	96	110
Standard coils for LC1D096 ... D386, LC1DT206...DT406, LC1D2586				
U 0.7...1.25 Uc	BD	SD	-	FD
Low consumption coils for LC1D096 ... D386, LC1DT206...DT406, LC1D2586				
U 0.7...1.25 Uc	BL	SL	DL	FL
Wide voltage range coils for LC1D406 ...956, LC1D400046 .... 800086				
U 0.7...1.25 Uc	BW	SW	-	FW

# TeSys Control

## TeSys Deca S207 - Contactors for railway applications

### Product references



CAD326FDS207

#### Contactors for control circuit - connection by lugs

Rated max operating current (Ie)	Composition	Commercial reference Replace dots by coil voltage code (see chart below)  coil with surge suppressor
<b>A</b>		
<b>5-pole contactors for control circuits</b>		
10	3 2	<b>CAD326●●S207</b>
	5 -	<b>CAD506●●S207</b>

#### Coil voltage codes

DC Volts	24	72	96	110
<b>Standard coils for CAD326, CAD506</b>				
U 0.7...1.25 Uc	BD	SD		FD
<b>Low consumption coils for CAD326, CAD506</b>				
U 0.7...1.25 Uc	BL	SL	DL	FL



LADN116

#### Instantaneous auxiliary contact blocks for connection by lugs <sup>(1)</sup>

Clip-on mounting <sup>(2)</sup>	Number of contacts per block	Composition	Reference
Front	2		<b>LADN116</b>
		2 -	<b>LADN206</b>
		- 2	<b>LADN026</b>
	4	2 2	<b>LADN226</b>
		1 3	<b>LADN136</b>
		4 -	<b>LADN406</b>
	- 4	<b>LADN046</b>	
	3 1	<b>LADN316</b>	

#### Maximum number of auxiliary contacts that can be fitted

Contactors		Instantaneous auxiliary contact blocks		
Type	Number of poles and size	Side mounted	Front mounted	
			2 contacts	4 contacts
---	3P LC1 D09...D38	-	1	or 1
		-	or 1	or 1
	4P LC1 DT20...DT40	-	1	or 1
		-	and 1	or 1
LC <sup>(3)</sup>	3P LC1 D09...D38	-	1	-
	4P LC1 DT20...DT40	-	1	-

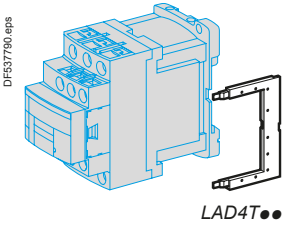

LAD4T●●

#### Bidirectional peak limiting diodes <sup>(1)</sup>

Protection provided by limiting the transient voltage to 2 Uc max.  
Maximum reduction of transient voltage peaks.

Mounting	For use with contactor Rating	Reference	
		Type	V ...
Clip-on side mounting <sup>(2)</sup>	D09...D38 (3P) DT20...DT40 (4P)	24	<b>LAD4TBDL</b>
		72	<b>LAD4TSDL</b>
		125	<b>LAD4TGDL</b>

- (1) Add on auxiliary contacts and bidirectional peak limiting diodes compliancy level to EN 45545 is R22 HL3.
- (2) In order to install these accessories, the existing suppression device must first be removed. Clipping-on makes the electrical connection. The overall size of the contactor remains unchanged.
- (3) LC: low consumption.



# TeSys Control

## TeSys Giga S207 - Contactors for railway applications

### Product references

PB123917.fr



LC1G115EHES207N

PB123918.eps



LC1G265EHES207N

PB123919.eps



LC1G630EHES207N

PB123920.eps



LC1G1154EHES207N

PB123921.eps



LC1G2654EHES207N

PB121650.eps



LAG8N113

DB43480a1

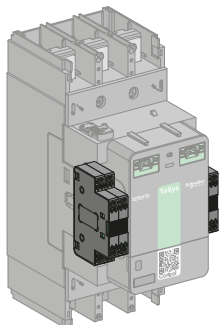

Side mounting – maximum 2 per side

### 3-pole contactors for Motor control - connection by lugs / bars

Standard power ratings of 3-phase motors 50-60 Hz in category AC-3 ( $\theta \leq 60^\circ\text{C}$ )							Rated operational current in AC-3 440 V up to	Instantaneous auxiliary contacts	Commercial reference	Weight
230 V	400 V	415 V	440 V	500 V	690 V	1000 V				
kW	kW	kW	kW	kW	kW	kW	A		48...130 V AC/DC coil	kg
30	55	55	75	75	75	-	115	1 1	LC1G115EHES207N	3.600
37	75	75	90	90	90	75	150	1 1	LC1G150EHES207N	3.600
55	90	90	110	110	110	75	185	1 1	LC1G185EHES207N	3.600
55	110	110	132	132	160	132	225	1 1	LC1G225EHES207N	3.600
75	132	132	160	160	200	160	265	1 1	LC1G265EHES207N	7.500
90	160	160	200	200	220	185	330	1 1	LC1G330EHES207N	7.500
110	200	200	250	250	315	220	400	1 1	LC1G400EHES207N	7.500
160	250	250	315	355	355	335	500	1 1	LC1G500EHES207N	7.500
200	335	375	400	400	500	450	630	1 1	LC1G630EHES207N	14.200
250	450	450	450	500	560	450	800	1 1	LC1G800EHES207N	14.200

### 4-pole contactors for Resistive load control - connection by lugs / bars

Non inductive loads maximum current ( $\theta \leq 40^\circ\text{C}$ ) utilisation category AC-1		Number of poles	Instantaneous auxiliary contacts	Commercial reference	Weight
A	kg				
250	4.400	4 -	1 1	LC1G1154EHES207N	4.400
275	4.400	4 -	1 1	LC1G1504EHES207N	4.400
305	4.400	4 -	1 1	LC1G1854EHES207N	4.400
330	4.400	4 -	1 1	LC1G2254EHES207N	4.400
385	8.200	4 -	1 1	LC1G2654EHES207N	8.200
440	8.200	4 -	1 1	LC1G3304EHES207N	8.200
550	8.200	4 -	1 1	LC1G4004EHES207N	8.200
700	8.200	4 -	1 1	LC1G5004EHES207N	8.200
1050	18.000	4 -	1 1	LC1G6304EHES207N	18.000
1050	18.000	4 -	1 1	LC1G8004EHES207N	18.000

### Auxiliary contact modules

Description	Terminal type	Position	Type of contacts	Sold in lots of	Reference
Auxiliary contact module	Push-in	1 <sup>st</sup> left or right	1 NO + 1 NC	1	LAG8N113P <sup>(1)</sup>
			2 NO	1	LAG8N203P
	2 <sup>nd</sup> left or right	1 NO + 1 NC	1	LAG8N113	
		2 NO	1	LAG8N203	

<sup>(1)</sup> Always supplied with TeSys Giga LC1G contactors, fitted to the right side lateral face.

# TeSys Control

## TeSys K, TeSys Deca and TeSys Giga contactors

### Product references

CAD326BDS207	LC1D126BDS207	LC1D400046FWS207	LC1G150EHES207N
CAD326BLS207	LC1D126BLS207	LC1D400046SWS207	LC1G1854EHES207N
CAD326FDS207	LC1D126FDS207	LC1D400086BWS207	LC1G185EHES207N
CAD326FLS207	LC1D126FLS207	LC1D400086FWS207	LC1G2254EHES207N
CAD326SDS207	LC1D126FLXS207	LC1D400086SWS207	LC1G225EHES207N
CAD326SLS207	LC1D126SDS207	LC1D406BWS207	LC1G2654EHES207N
CAD506BDS207	LC1D126SLS207	LC1D406FWS207	LC1G265EHES207N
CAD506FDS207	LC1D1286BDS207	LC1D406SWS207	LC1G3304EHES207N
CAD506FLS207	LC1D1286BLS207	LC1D506BWS207	LC1G330EHES207N
CAD506SDS207	LC1D1286FDS207	LC1D506FWS207	LC1G4004EHES207N
CAK226BLS207	LC1D1286FLS207	LC1D506SWS207	LC1G400EHES207N
CAK226FLS207	LC1D1286SLS207	LC1D656BWS207	LC1G5004EHES207N
CAK226SLS207	LC1D186BDS207	LC1D656FWS207	LC1G500EHES207N
CAK316BLS207	LC1D186BLS207	LC1D656SWS207	LC1G6304EHES207N
CAK316FLS207	LC1D186FDS207	LC1D800046BWS207	LC1G630EHES207N
CAK316SLS207	LC1D186FLS207	LC1D800046FWS207	LC1G8004EHES207N
CAK406BLS207	LC1D186SDS207	LC1D800046SWS207	LC1G800EHES207N
CAK406FLS207	LC1D186SLS207	LC1D800086BWS207	LC1K06016BLS207
CAK406SLS207	LC1D1886BLS207	LC1D800086FWS207	LC1K06016FLS207
LA1KN02	LC1D1886FDS207	LC1D800086SWS207	LC1K06016SLS207
LA1KN11	LC1D1886FLS207	LC1D806BWS207	LC1K06106BLS207
LA1KN20	LC1D256BDS207	LC1D806FWS207	LC1K06106FLS207
LA1KN226	LC1D256BLS207	LC1D806SWS207	LC1K06106SLS207
LA1KN406	LC1D256FDS207	LC1D956BWS207	LC1K09016BLS207
LAD4TBDL	LC1D256FLS207	LC1D956FWS207	LC1K09016FLS207
LAD4TGDL	LC1D256SDS207	LC1D956SWS207	LC1K09016SLS207
LAD4TSDL	LC1D256SLS207	LC1DT206BDS207	LC1K09106BLS207
LADN026	LC1D256SLXS207	LC1DT206BLS207	LC1K09106FLS207
LADN046	LC1D2586BDS207	LC1DT206FLS207	LC1K09106SLS207
LADN116	LC1D2586BLS207	LC1DT206SLS207	LC1K0986BLS207
LADN136	LC1D2586FDS207	LC1DT256BDS207	LC1K0986FLS207
LADN206	LC1D2586FLS207	LC1DT256BLS207	LC1K12016BLS207
LADN226	LC1D2586SLS207	LC1DT256FDS207	LC1K12016FLS207
LADN316	LC1D326BDS207	LC1DT256FLS207	LC1K12016SLS207
LADN406	LC1D326BLS207	LC1DT256SDS207	LC1K12106BLS207
LC1D096BDS207	LC1D326FDS207	LC1DT326BDS207	LC1K12106FLS207
LC1D096BLS207	LC1D326FLS207	LC1DT326FLS207	LC1K12106SLS207
LC1D096FDS207	LC1D326SDS207	LC1DT406BDS207	LC1KT206BLS207
LC1D096FLS207	LC1D326SLS207	LC1DT406BLS207	LC1KT206FLS207
LC1D096SDS207	LC1D386BDS207	LC1DT406FDS207	LC1KT206SLS207
LC1D096SLS207	LC1D386BLS207	LC1DT406FLS207	LC2D096SLS207
LC1D0986BDS207	LC1D386FDS207	LC1DT406SWS207	LRD08S207
LC1D0986BLS207	LC1D386FLS207	LC1DT406SLS207	LRD10S207
LC1D0986FDS207	LC1D386SDS207	LC1G1154EHES207N	LRD12S207
LC1D0986FLS207	LC1D386SLS207	LC1G115EHES207N	LRD16S207
LC1D0986SLS207	LC1D400046BWS207	LC1G1504EHES207N	

This document is current.  Click on the product reference to get the most recent availability status (hyperlink to [se.com](https://www.se.com) product datasheet). If your product variant is no longer available, please consult your distributor or regional sales office.





# Technical Data for Designers

## Contents

### TeSys K S207 series:

Characteristics.....	16 to 19
Dimensions and schemes.....	20

### TeSys Deca S207 series:

Characteristics.....	21 to 24
Dimensions.....	25
Schemes.....	26

### TeSys Giga S207 series:

Characteristics.....	27
Dimensions and schemes.....	32

# TeSys Control

## TeSys K S207 - Contactors for railway applications

### Characteristics

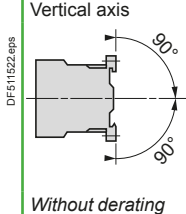
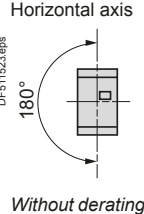
Environment characteristics			
<b>Contactors type LC1K</b>			
Conforming to standards			IEC/EN 60947-4-1, IEC/EN 60947-5-1, GB/T 14048.4, GB/T 14048.5, EN 45545 R22 HL3, EN 45545 R26 HL3, IEC/EN 61373
Authorized operating positions			Vertical axis  Horizontal axis  Without derating      Without derating
Rated insulation voltage (Ui)	Conforming to IEC 60947	<b>V</b>	690
	Conforming to VDE 0110 gr C	<b>V</b>	750
	Conforming to BS 5424, NF C 20-040	<b>V</b>	690
Rated impulse withstand voltage (Uimp)		<b>kV</b>	8
Protective treatment	Conforming to IEC 60068 (DIN 50016)		"TC" (Klimafest, Climateproof)
Degree of protection	Conforming to VDE 0106		Protection against direct finger contact
Ambient air temperature around the device	Storage	<b>°C</b>	-50...+80
	Operation	<b>°C</b>	-25...+50
	Permissible	<b>°C</b>	-40...+70, for operation at Uc
Maximum operating altitude	Without derating	<b>m</b>	2000
Vibration resistance 5 ... 300 Hz	Contactors open		2 gn
	Contactors closed		4 gn
Flame resistance	Conforming to UL 94		V0
Shock resistance (1/2 sine wave, 11 ms)	Contactors open		On X axis: 6 gn On Y and Z axes: 10 gn
	Contactors closed		On X axis: 10 gn On Y and Z axes: 15 gn
Connection by lugs			
Lug external Ø		<b>mm</b>	7
Ø of screw		<b>mm</b>	3.2
Screwdriver	Philips / Pozidriv		N° 2
	Flat screwdriver Ø	<b>mm</b>	Ø6
Tightening torque		<b>N.m</b>	1.1 recommended, 1.3 max

# TeSys Control

## TeSys K S207 - Contactors for railway applications

### Characteristics

Pole characteristics						
Type			LC1K06	LC1K09, LC1KT09, LC1KT20	LC1K12	
Conventional thermal current (I <sub>th</sub> )	For ambient temperature ≤ 50 °C	A	20			
Rated operational frequency		Hz	50/60			
Frequency limits of the operational current		Hz	Up to 400			
Rated operational voltage (U <sub>e</sub> )		V	690			
Rated making capacity	I rms conforming to NF C 63 110 and IEC 60947	A	110	110	144	
Rated breaking capacity	I rms conforming to NF C 63 110 and IEC 60947	220/230 V	A	110	110	–
		380/400 V	A	110	110	–
		415 V	A	110	110	–
		440 V	A	110	110	110
		500 V	A	80	80	80
		660/690 V	A	70	70	70
Permissible short time rating	In free air for a time "t" from cold state (θ ≤ 50 °C)	1 s	A	90	90	115
		5 s	A	85	85	105
		10 s	A	80	80	100
		30 s	A	60	60	75
		1 min	A	45	45	55
		3 min	A	40	40	50
		≥ 15 min	A	20	20	25
Short-circuit protection	gG fuse U ≤ 440 V	A	25			
Average impedance per pole	At I <sub>th</sub> and 50 Hz	mΩ	3			
Use in category AC-1 resistive circuits, heating, lighting (U <sub>e</sub> ≤ 440 V)	Maximum rated operational current for a temperature ≤ 50 °C	A	20			
		A	16 for U <sub>e</sub> only			
	Rated operational current limits in relation to the on-load factor and operating frequency			On-load factor		90 %
		A		300 operating cycles/hour		13
		A		120 operating cycles/hour		15
A		30 operating cycles/hour		19		
Increase in rated operational current by paralleling of poles			Apply the following coefficients to the above currents; these coefficients take into account an often unbalanced distribution of current between the poles			
			2 poles in parallel: K = 1.60			
			3 poles in parallel: K = 2.25			
			4 poles in parallel: K = 2.80			
Use in category AC-3 squirrel cage motors	Operational power according to the voltage. Voltage 50 or 60 Hz	115 V single-ph.	kW	0.37	0.55	–
		220 V single-ph.	kW	0.75	1.1	–
		220/230 V 3-ph.	kW	1.5	2.2	3
		380/415 V 3-ph.	kW	2.2	4	5.5
		440/480 V 3-ph.	kW	3	4	5.5/4 (480)
		500/600 V 3-ph.	kW	3	4	4
		660/690 V 3-ph.	kW	3	4	4
Maximum operating rate (in operating cycles/hour in relation to % of rated power)			Op. cycles/h	600		
			Power	100 %		



# TeSys Control

## TeSys K S207 - Contactors for railway applications

### Characteristics

Control circuit characteristics			
Type		LC1K, LC1KT	CAK
Rated control circuit voltage (Uc)	<b>V DC</b>	24...110	24...110
Control voltage limits ( $\leq 50\text{ }^{\circ}\text{C}$ ) single voltage coil	Operation	0.7...1.30 Uc	0.7...1.3 Uc
	Drop-out	$\geq 0.10\text{ }U_c$	$\leq 0.1\text{ }U_c$
Average consumption at 20 °C and at Uc	Inrush	1.8 W	1.8 W
	Sealed	1.8 W	1.8 W
Heat dissipation	<b>W</b>	1.8	1.8
Operating time at 20 °C and at Uc			
Between coil energisation and:	opening of the N/C contacts	<b>ms</b> 25...35	25...35
	closing of the N/O contacts	<b>ms</b> 30...40	30...40
Between coil de-energisation and:	opening of the N/O contacts	<b>ms</b> 10...20	10...20
	closing of the N/C contacts	<b>ms</b> 15...25	15...25
Maximum immunity to microbreaks	<b>ms</b>	2	2
Maximum operating rate	In operating cycles per hour	3600	6000
Mechanical durability at Uc In millions of operating cycles		30	30

# TeSys Control

## TeSys K S207 - Contactors for railway applications

### Characteristics

#### LC1K auxiliary contacts, CAK

Number of auxiliary contacts	On LP● K 3-pole		1
Rated operational voltage (Ue)	Up to	V	690
Rated insulation voltage (Ui)	Conforming to BS 5424	V	690
	Conforming to IEC 60947	V	690
	Conforming to VDE 0110 group C	V	750
	Conforming to CSA C 22-2 n° 14	V	600
Conventional thermal current (Ith)	For ambient temperature ≤ 50 °C	A	10
Frequency of the operational current		Hz	Up to 400
Minimum switching capacity	U min (DIN 19 240)	V	17
	I min	mA	5
Short-circuit protection	Conforming to IEC 60947 and VDE 0660, gG fuse	A	10
Rated making capacity	Conforming to IEC 60947	I rms	A 110
Short-time rating	Permissible for	1 s	A 80
		500 ms	A 90
		100 ms	A 110

Power broken in VA

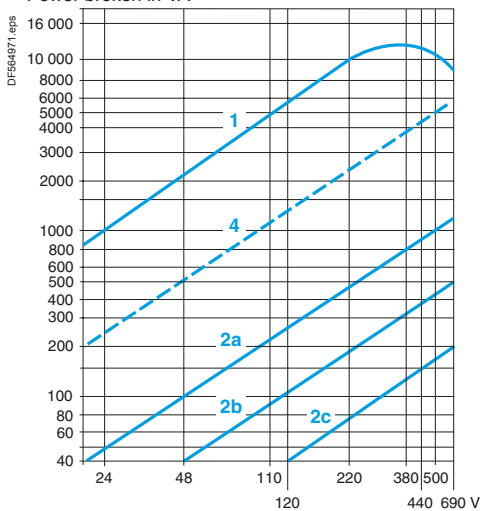

Power broken in W

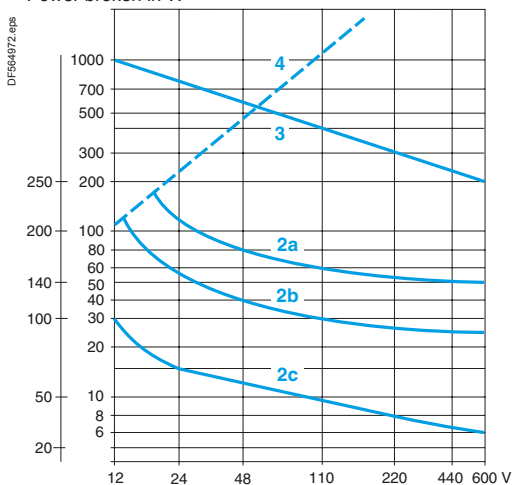

#### Operational power of contacts conforming to IEC 60947 a.c. supply, category AC-15

Electrical durability (valid for up to 3600 operating cycles/hour) on an inductive load such as the coil of an electromagnet: making current ( $\cos \varphi 0.7$ ) = 10 times the power broken ( $\cos \varphi 0.4$ ).

Operating cycles	V	24		48		110		220		380		600	
		24	48	127	230	400	440	690	690				
1 million operating cycles	VA	48	96	240	440	800	880	1200					
3 million operating cycles	VA	17	34	86	158	288	317	500					
10 million operating cycles	VA	7	14	36	66	120	132	200					
Occasional making capacity	VA	1000	2050	5000	10000	14000	13000	9000					

#### d.c. supply, category DC-13

Electrical durability (valid for up to 1200 operating cycles/hour) on an inductive load such as the coil of an electromagnet, without economy resistor, the time constant increasing with the load.

Operating cycles	V	24		48		110		220		440		600	
		24	48	120	80	60	52	51	50				
1 million operating cycles	W	120	80	60	52	51	50						
3 million operating cycles	W	55	38	30	28	26	25						
10 million operating cycles	W	15	11	9	8	7	6						
Occasional making capacity	W	720	600	400	300	230	200						

- Breaking limit of contacts valid for:
  - maximum of 50 operating cycles at 10 s intervals (power broken = making current x  $\cos \varphi 0.7$ ).
- Electrical durability of contacts for:
  - 1 million operating cycles (2a)
  - 3 million operating cycles (2b)
  - 10 million operating cycles (2c).
- Breaking limit of contacts valid for:
  - maximum of 20 operating cycles at 10 s intervals with current passing for 0.5 s per operating cycle.
- Thermal limit.

# TeSys Control

## TeSys K S207 - Contactors for railway applications

### Dimensions and schemes

#### Contactors

##### LC1K, LC1KT, CAK

On panel

On mounting rail AM1 DP200 or AM1 DE200 (7 35 mm)

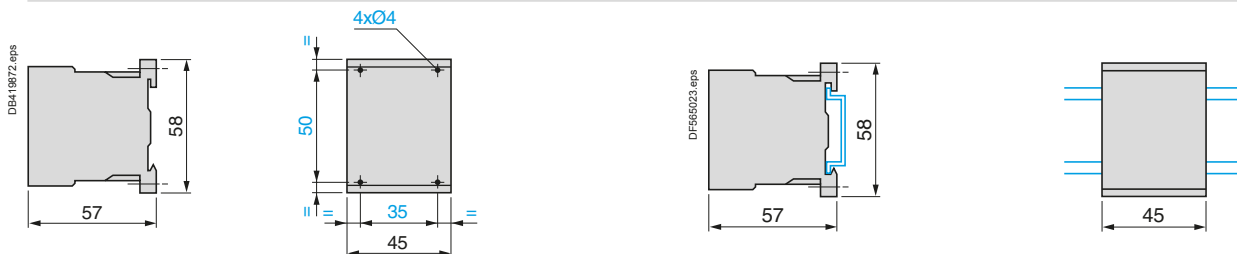

#### 3-pole contactors

3 P + N/O

3 P + N/C

#### Coil diagram with integral suppression device LC1K, LC1KT

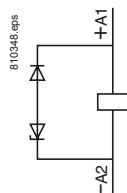
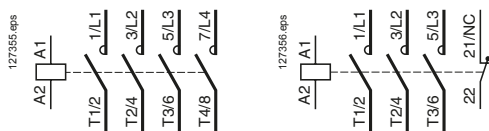

#### 4-pole contactors

4 P

2 P N/O + 2 P N/C

#### Coil diagram with integral suppression device LC1K, LC1KT

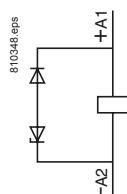
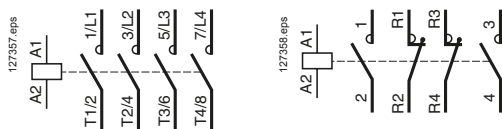

#### CAK - 4 poles contactors for control circuits

4 N/O

3 N/O + 1 N/C

2 N/O + 2 N/C

#### Coil diagram - with suppression device CAK

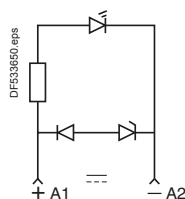
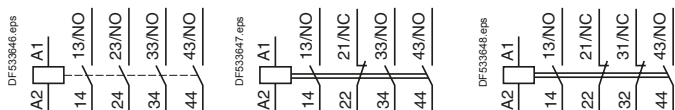

# TeSys Control

## TeSys Deca S207 - Contactors for railway applications

### Characteristics

3-pole contactor characteristics													
Contactor type			LC1D096	LC1D126	LC1D186	LC1D256	LC1D326	LC1D386	LC1D406	LC1D506	LC1D656	LC1D806	LC1D956
Rated operational current (Ie) (Ue ≤ 440 V)	In AC-3 / AC-3e, θ ≤ 60 °C	<b>A</b>	9	12	18	25	32	38	40	50	65	80	95
	In AC-1, θ ≤ 60 °C	<b>A</b>	25	25	32	40	50	50	60	80	80	125	125
Rated operational voltage (Ue)	Up to	<b>V</b>	690	690	690	690	690	690	1000	1000	1000	1000	1000
Frequency limits	Of the operational current	<b>Hz</b>	25...400	25...400	25...400	25...400	25...400	25...400	25...400	25...400	25...400	25...400	25...400
Conventional thermal current (Ith)	θ ≤ 60 °C	<b>A</b>	25	25	32	40	50	50	60	80	80	125	125
Rated making capacity (440 V)	Conforming to IEC 60947	<b>A</b>	250	250	300	450	550	550	800	900	1000	1100	1100
Rated breaking capacity (440 V)	Conforming to IEC 60947	<b>A</b>	250	250	300	450	550	550	800	900	1000	1100	1100
Permissible short time rating No current flowing for preceding 15 minutes with θ ≤ 40 °C	For 1 s	<b>A</b>	210	210	240	380	430	430	720	810	900	990	1100
	For 10 s	<b>A</b>	105	105	145	240	260	310	320	400	520	640	800
	For 1 min	<b>A</b>	61	61	84	120	138	150	165	208	260	320	400
	For 10 min	<b>A</b>	30	30	40	50	60	60	72	84	110	135	135
Fuse protection against short-circuits (U ≤ 690 V)	Without type 1 thermal overload relay, gG fuse	<b>A</b>	25	40	50	63	63	63	80	100	160	200	200
	type 2	<b>A</b>	20	25	35	40	63	63	80	100	125	160	160
Average impedance per pole	At Ith and 50 Hz	<b>mΩ</b>	2.5	2.5	2.5	2	2	2	1.5	1.5	1	0,8	0,8
Power dissipation per pole for the above operational currents	AC-3 / AC-3e	<b>W</b>	0.20	0.36	0.8	1.25	2	3	2.4	3.7	4.2	5.1	7.2
	AC-1	<b>W</b>	1.56	1.56	2.5	3.2	5	5	5.4	9.6	6.4	12.5	12.5



# TeSys Control

## TeSys Deca S207 - Contactors for railway applications

### Characteristics

4-pole contactor characteristics			LC1D0986 LC1DT206	LC1D1286 LC1DT256	LC1D1886 LC1DT326	LC1D2586 LC1DT406	LC1D400046 LC1D400086	LC1D800046 LC1D800086
Rated operational current (Ie) (Ue ≤ 440 V)	In AC-3 / AC-3e, θ ≤ 60 °C	<b>A</b>	9	12	18	25	40 <sup>(1)</sup>	80 <sup>(2)</sup>
	In AC-1, θ ≤ 60 °C	<b>A</b>	20	25	32	40	60	125
Rated operational voltage (Ue)	Up to	<b>V</b>	690	690	690	690	690	1000
Frequency limits	Of the operational current	<b>Hz</b>	25...400	25...400	25...400	25...400	25...400	25...400
Conventional thermal current (Ith)	θ ≤ 60 °C	<b>A</b>	20	25	32	40	60	125
Rated making capacity (440 V)	Conforming to IEC 60947	<b>A</b>	250	250	300	450	800	1100
Rated breaking capacity (440 V)	Conforming to IEC 60947	<b>A</b>	250	250	300	450	800	1100
Permissible short time rating No current flowing for preceding 15 minutes with θ ≤ 40 °C	For 1 s	<b>A</b>	210	210	240	380	720	990
	For 10 s	<b>A</b>	105	105	145	240	320	640
	For 1 min	<b>A</b>	61	61	84	120	165	320
	For 10 min	<b>A</b>	30	30	40	50	72	135
Fuse protection against short-circuits (U ≤ 690 V)	Without type 1 thermal overload relay, gG fuse	<b>A</b>	25	40	50	63	80	200
	type 2	<b>A</b>	20	25	35	40	80	160
Average impedance per pole	At Ith and 50 Hz	<b>mΩ</b>	2.5	2.5	2.5	2	1.5	0,8
Power dissipation per pole for the above operational currents	AC-3 / AC-3e	<b>W</b>	0.20	0.36	0.8	1.25	2.4	5.1
	AC-1	<b>W</b>	1.56	1.56	2.5	3.2	5.4	12.5

(1) For LC1D400046 only, no AC-3 for LC1D400086.

(2) For LC1D800046 only, no AC-3 for LC1D800086.

# TeSys Control

## TeSys Deca S207 - Contactors for railway applications

### Characteristics

Environment					
Contactor type			LC1D096...D186, LC1DT206 and LC1DT256	LC1D256...D386, LC1DT326 and LC1DT406	LC1D406..D956, LC1D400046, LC1D400086, LC1D650046, LC1D650086, LC1D800046, LC1D800086
Rated insulation voltage (Ui)	Conforming to IEC 60947-4-1, overvoltage category III, degree of pollution: 3	V	690		1000
Rated impulse withstand voltage (Uimp)	Conforming to IEC 60947	kV	6		8
Conforming to standards			IEC/EN 60947-4-1, IEC/EN 60947-5-1, GB/T 14048.4, GB/T 14048.5, EN 45545 R22 HL3, EN 45545 R26 HL3, IEC/EN 61373		
Product certifications			IEC, CCC, EAC, UA, TR		IEC, CCC
Degree of protection (front face)	Conforming to IEC 60529				
	Power circuit connections		Protection against direct finger contact IP20		
	Coil connection		Protection against direct finger contact IP20		
Climatic withstand			According to IACS E10		
Ambient air temperature around the device	Storage	°C	-60...+80		
	Operation	°C	-40...+70		-25...+70
Maximum operating altitude	Without derating	m	3000		
Operating positions <sup>(1)</sup>	Without derating in the following positions (other positions: please contact us).		<div style="display: flex; justify-content: space-around; align-items: center;"> <div style="text-align: center;"> </div> <div style="text-align: center;"> </div> </div>		
	Positions that are not permissible		For  contactors LC1D09 to LC1D95. <div style="display: flex; justify-content: space-around; align-items: center; margin-top: 10px;"> <div style="text-align: center;"> </div> <div style="text-align: center;"> </div> </div>		
Flame resistance	Conforming to UL 94		V0		
	Conforming to IEC 60695-2-1	°C	850		
Shock resistance <sup>(2)</sup> 1/2 sine wave = 11 ms	Contactor open		10 gn	8 gn	8 gn
	Contactor closed		15 gn	15 gn	10 gn
Vibration resistance <sup>(2)</sup> 5...300 Hz	Contactor open		2 gn		
	Contactor closed		4 gn	4 gn	3 gn

<sup>(1)</sup> When mounting on a vertical rail, use a stop.

<sup>(2)</sup> Without modification of power contact states, in the most unfavourable direction (coil energised at Ue).

# TeSys Control

## TeSys Deca S207 - Contactors for railway applications

### Characteristics

Power circuit connections								
Contactor type		LC1D096, LC1D126, LC1D186, LC1DT206, LC1DT256	LC1D1886 LC1DT326	LC1D256 LC1D326 LC1D386	LC1D2586 LC1DT406	LC1D406, LC1D4000	LC1D506 LC1D656 LC1D6500	LC1D806 LC1D956 LC1D800046 LC1D800086
Connection by bars or lugs								
Lug external Ø	mm	8	9	12	9	13	16	17
Ø of screw	mm	M3.5		M4	M3.5	M5	M6	M6
Screwdriver	Philips / Pozidriv	N° 2		N° 2	N° 2	N° 2	N° 3	-
	Flat screwdriver Ø	Ø6		Ø6	Ø6	Ø8	Ø8	Ø8
Key for hexagonal headed screw		-		-	-	-	-	10
Tightening torque	N.m	1.7		2.5	1.8	2.5	2.5	5

Control circuit connections		
Connection by bars or lugs		
Lug external Ø	mm	8
Ø of screw	mm	M3.5
Screwdriver	Philips / Pozidriv	N° 2
	Flat screwdriver Ø	Ø6
Tightening torque	N.m	1.7

d.c. control circuit characteristics						
Compatible contactor types		Standard coil	Low consumption coil	Wide range coil		
		LC1D096...D386 LC1DT206...DT406 LC1D2586	LC1D096...D386 LC1DT206...DT406 LC1D2586	LC1D406...956 LC1D400046...LC1D800086		
Rated insulation voltage	Conforming to IEC 60947-1	V	690			
Operating ranges from -40 to +70°C	Side by side mounting		0.7...1.1 Uc	0.7...1.25 Uc	Uc	
	With 8 mm spacing		0.7...1.25 Uc	-	-	
Operating ranges from -25 to +50°C	Side by side mounting		0.7...1.25 Uc	-	0.7 ... 1.25 Uc	
Average consumption at 20 °C and at Uc	---	W	5.4	4	22	
Operating time <sup>(1)</sup> average at Uc	Closing of NO contacts	"C"	ms	55 to 75	55 to 75	95 to 130
		Opening of NC contacts	ms	45 to 65	45 to 65	-
	Opening of NO contacts	"O"	ms	16 to 32 (12 to 22 ms without diode)	16 to 32 (12 to 22 ms without diode)	20 to 35
		Closing of NC contacts	ms	27 to 42 (18 to 28 ms without diode)	27 to 42 (18 to 28 ms without diode)	-
<i>Note: The arcing time depends on the circuit switched by the poles. For all normal 3-phase applications, the arcing time is less than 10 ms. The load is isolated from the supply after a time equal to the sum of the opening time and the arcing time.</i>						
Time constant (L/R)		ms	28	37	75	
Mechanical durability at Uc	In millions of operating cycles		30	30	10	
Maximum operating rate at ambient temperature ≤ 60 °C	In operating cycles per hour		3600	3600	3600	

(1) The operating times depend on the type of contactor electromagnet and its control mode.  
 The closing time "C" is measured from the moment the coil supply is switched on to initial contact of the main poles.  
 The opening time "O" is measured from the moment the coil supply is switched off to the moment the main poles separate.

Characteristics of auxiliary contacts incorporated in the contactor			
Mechanically linked contacts	Conforming to IEC 60947-5-1		Each TeSys Deca NO/NC embedded auxiliary contacts are certified 'mechanically linked'.
Mirror contact	Conforming to IEC 60947-4-1		All TeSys Deca NC auxiliary contacts are 'mirror' certified and can be connected to a safety module.
Rated operational voltage (Ue)	Up to	V	690
Rated insulation voltage (Ui)	Conforming to IEC 60947-1	V	690
Conventional thermal current (Ith)	For ambient temperature ≤ 60 °C	A	10

# TeSys Control

## TeSys Deca S207 - Contactors for railway applications

### Dimensions

#### LC1D09...D18 (3-pole)

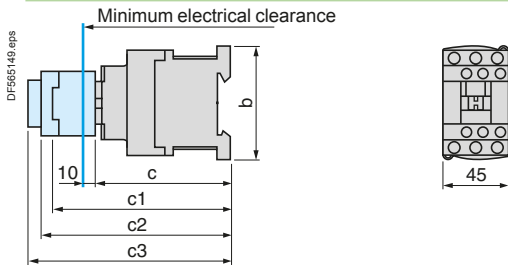

#### LC1D25...D38 (3-pole)

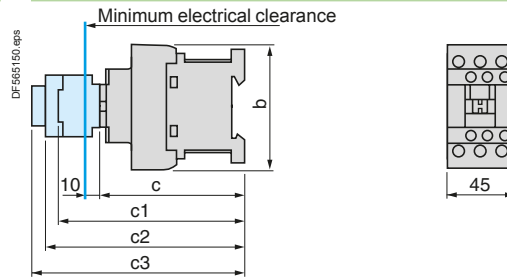

#### LC1DT20...DT40, LC1D098, D128, D188, D258 (4-poles)

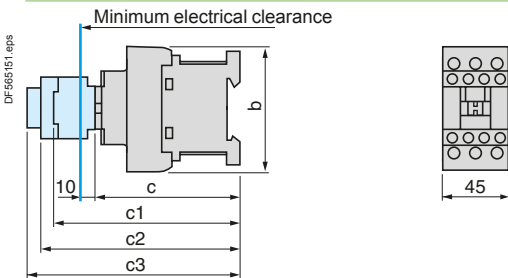

LC1	D09...D18	D25...D38	DT20 and DT25 D098 and D128	DT32 and DT40 D188 and D258
b without add-on blocks	77	85	85	91
c without cover or add-on blocks	93	99	—	—
with cover, without add-on blocks	95	101	99	107
c1 with LAD N or C (2 or 4 contacts)	126	132	123	131
c2 with LA6 DK10, LAD 6K10	138	144	135	143
c3 with LAD T, R, S	146	152	143	151
with LAD T, R, S and sealing cover	150	156	147	155

#### LC1D406..S207, LC1D506..S207, LC1D656..S207 (3-pole)

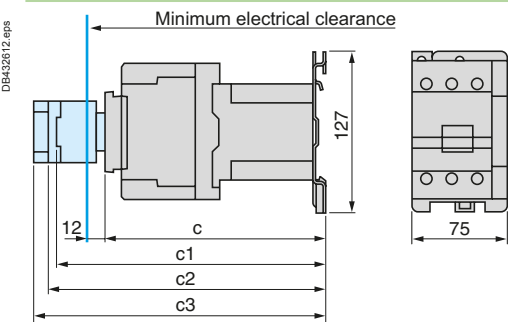

#### LC1D806..S207, LC1D956..S207 (3-pole)

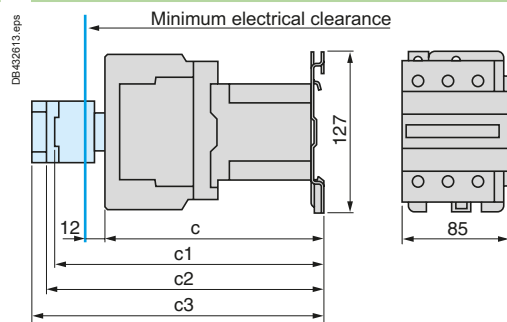

#### LC1D400046..S207 (3-pole), LC1D400086..S207 (4-pole)

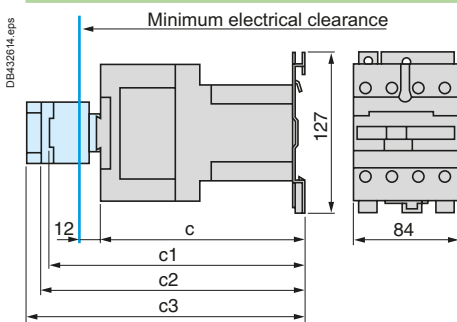

#### LC1D800046..S207, LC1D800086..S207 (4-pole)

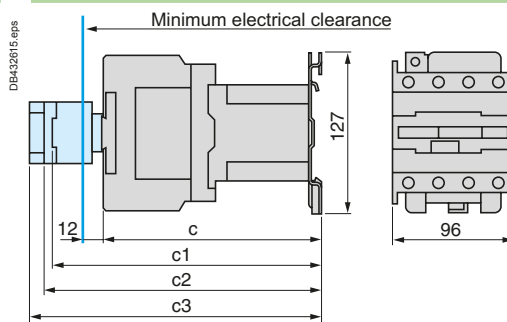

	LC1D406..S207, LC1D506..S207, LC1D656..S207	LC1D806..S207, LC1D956..S207	LC1D400046..S207	LC1D400086..S207	LC1D800046	LC1D800086
c without cover or add-on blocks	171	181	171	182	181	196
with cover, without add-on blocks	176	186	—	—	—	—
c1 with LAD N (1 contact)	196	204	196	196	204	204
with LAD N or C (2 or 4 contacts)	202	210	202	202	210	210
c2 with LA6 DK10	213	221	213	213	221	221
c3 with LAD T, R, S	221	229	221	221	229	229
with LAD T, R, S and sealing cover	225	233	225	225	233	233



# TeSys Control

## TeSys Deca S207 - Contactors for railway applications

### Schemes

#### Contactors

##### 3-pole contactors

LC1D096 ... LC1D956

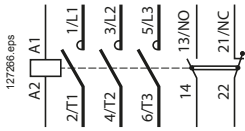

##### 4-pole contactors

LC1DT206... DT406

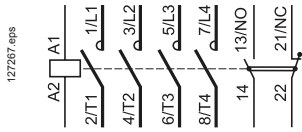

LC1D0986...D2586

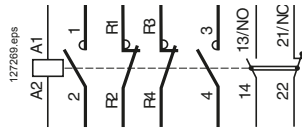

LC1D400046, LC1D800046

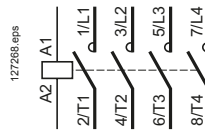

LC1D400086, LC1D800086

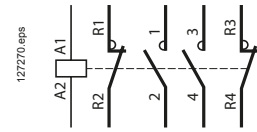

# TeSys Control

## TeSys Giga S207 - Contactors for railway applications

### Characteristics

Environment					
Contactor type			LC1G115... 225	LC1G265... 500	LC1G630... 800
Rated insulation voltage (Ui)	Conforming to IEC 60947-4-1, overvoltage category III, degree of pollution: 3	V	1000	1000	1000
Rated impulse withstand voltage (Uimp)	Coil not connected to the power circuit	kV	8	8	8
Conforming to standards			IEC/EN 60947-4-1, UL 60947-4-1, CSA C22.2 n° 60947-4-1, JIS C 8201-4-1, GB/T 14048.4, IEC 60721-3-3 3C3, EN 45545 R22 HL2, IEC 61373, IEC 60077, EN 50155, TB/T 3526-2018, GB 21413-1/2, GB/T 25119, GB/T 21563-2018		
Product certifications			CB scheme, CCC Mark, cULus, EAC, UKCA Marking		
Electromagnetic compatibility			IEC 60947-4-1		
Immunity			Following IEC 60947-4-1 Table 14		
Emission			Environment A according to IEC 60947-4-1		
Immunity to radiated electromagnetic interference			20 V/m according to IEC/EN 61000-4-3		
Voltage sag immunity (in complete product as well)			Conforming to SEMI-F47		
Degree of protection	Conforming to IEC 60529 / VDE 0106		IP2x with terminal shrouds LA9G37●●/ LA9G47●●		
Climatic withstand			According to IACS E10		
Ambient air temperature around the device	Storage	°C	-60...+80		
	Operation	°C	-25...+60		
	Permissible at Uc	°C	-40...+70		
Net weight	3P	kg	3.6	7.5	14.2
	4P	kg	4.4	8.2	18
Maximum operating altitude	Without derating	m	3000		
Operating positions	Without derating				
	With derating <sup>(1)</sup>				
Shock resistance 1/2 sine wave = 11 ms Conforming to IEC 60068-2-7	Contacteur open		10 gn	10 gn	10 gn
	Contacteur closed		15 gn	15 gn	15 gn
Vibration resistance 5...300 Hz Conforming to IEC 60068-2-6	Contacteur open		2 gn	2 gn	2 gn
	Contacteur closed		4 gn	4 gn	4 gn

<sup>(1)</sup> For derating details, please contact your Technical Support.

# TeSys Control

## TeSys Giga S207 - Contactors for railway applications

### Characteristics

3 Pole & 4 Pole characteristics					
Contactor type		LC1G115	LC1G150	LC1G185	LC1G225
Number of poles		3 or 4	3 or 4	3 or 4	3 or 4
Rated operational current (I <sub>e</sub> )	U <sub>e</sub> ≤ 400 V 3P In AC-3 / AC-3e, θ ≤ 60 °C	A 115 / 115	150 / 145	185 / 177	225 / 209
	U <sub>e</sub> ≤ 1000 V 3P & 4P In AC-1, θ ≤ 40 °C	A 250	275	305	330
Rated operational voltage (U <sub>e</sub> )		V Up to 1000 <sup>(1)</sup>	1000	1000	1000
Rated frequency (f) <sup>(2)</sup>		Hz 50 / 60	50 / 60	50 / 60	50 / 60
Frequency operating limits With derating <sup>(3)</sup>		Hz 16 <sup>2/3</sup> ...400	16 <sup>2/3</sup> ...400	16 <sup>2/3</sup> ...400	16 <sup>2/3</sup> ...400
Conventional thermal current θ ≤ 40 °C		A 250	275	305	330
Rated making capacity I rms conforming to IEC 60947-4-1		A	Making current: 10 x I in AC-3 or 12 x I in AC-4 Making current: 13 x I in AC-3e		
Rated breaking capacity I rms conforming to IEC 60947-4-1		A	Making and breaking current: 8 x I in AC-3 or 10 x I in AC-4 Making and breaking current: 8.5 x I in AC-3e		
Maximum permissible current No current flowing for previous 60 minutes, at θ ≤ 40 °C	For 10 s	A 1100	1200	1500	1800
	For 30 s	A 640	700	920	1000
	For 1 min	A 520	600	740	850
	For 3 min	A 400	450	500	560
	For 10 min	A 320	350	400	440
Short-circuit protection by fuses	Fuses for motor: type aM - U <sub>e</sub> ≤ 440 V	A 125	160	200	250
	Fuses for motor: type aM - U <sub>e</sub> ≤ 690 V	A 125	160	160	200
	Fuses for general application: type gG - U <sub>e</sub> ≤ 690 V	A 315	315	315	400
Average impedance per pole At I <sub>th</sub> and 50 Hz		mΩ 0.18	0.18	0.17	0.15
Power dissipation per pole for the above operational currents	AC-3 / AC-3e	W 3	5	6	8
	AC-1	W 10	10	20	20

(1) U<sub>e</sub> ≤ 1000 V for AC-1 / U<sub>e</sub> ≤ 690 V for AC-3 / AC-3e / AC-4.

(2) Please consult your technical support team for application with frequencies other than 50/60 Hz.

(3) For derating details, please contact technical support.

# TeSys Control

## TeSys Giga S207 - Contactors for railway applications

### Characteristics

3 Pole & 4 Pole characteristics					
LC1G265	LC1G330	LC1G400	LC1G500	LC1G630	LC1G800
3 or 4	3 or 4	3 or 4	3 or 4	3 or 4	3 or 4
265 / 255	330 / 294	400 / 391	500 / 437	630 / 555	800 / 587
385	440	550	700	1050	1050
1000	1000	1000	1000	1000	1000
50 / 60	50 / 60	50 / 60	50 / 60	50 / 60	50 / 60
16 <sup>2/3</sup> ...400	16 <sup>2/3</sup> ...400	16 <sup>2/3</sup> ...400	16 <sup>2/3</sup> ...400	16 <sup>2/3</sup> ...400	16 <sup>2/3</sup> ...400
385	440	550	700	1050	1050
Making current: 10 x I in AC-3 or 12 x I in AC-4					
Making current: 13 x I in AC-3e					
Making and breaking current: 8 x I in AC-3 or 10 x I in AC-4					
Making and breaking current: 8.5 x I in AC-3e					
2200	2650	3600	4000	5050	5500
1230	1800	2400	2800	4400	4600
950	1300	1700	2200	3400	3600
620	900	1200	1500	2200	2600
480	750	1000	1200	1600	1700
315	400	500	500	630	800
250	250	315	400	500	630
400	500	630	800	1250	1250
0.144	0.144	0.1	0.08	0.065	0.065
11	16	16	20	26	42
20	30	30	40	70	70







# TeSys Control

## TeSys Giga S207 - Contactors for railway applications

### Characteristics

Power circuit connections														
Contactor type			LC1	G115	G150	G185	G225	G265	G330	G400	G500	G630	G800	
Connection				Maximum c.s.a.										
Bar	Number of bars	Bar		2	2	2	2	2	2	2	2	2	2	
		Bar	mm	25 x 6	25 x 6	25 x 6	25 x 6	32 x 10	32 x 10	32 x 10	32 x 10	52 x 20	52 x 20	
	Cable with lug		mm <sup>2</sup>	185	185	185	185	240	2 x 150	2 x 185	2 x 240	-	-	
		Cable with connector	mm <sup>2</sup>	185	185	185	185	240	-	-	-	-	-	
		Bolt diameter	mm	Ø8.5	Ø8.5	Ø8.5	Ø8.5	Ø10.6	Ø10.6	Ø10.6	Ø10.6	Ø13	Ø13	
Tightening torque			Power circuit connections	N.m	18	18	18	18	35	35	35	35	58	58

Control circuit connections					LC1G115...225	LC1G265...330	LC1G400...500	LC1G630...800
Coil control connection (Push-in type)					Min/max c.s.a.			
Flexible cable	1 conductor with cable end		mm <sup>2</sup>		0.25...2.5	0.25...2.5	0.25...2.5	0.25...2.5
					2 conductors with Dual Sleeve	mm <sup>2</sup>		0.5...1
Solid cable	1 conductor		mm <sup>2</sup>		0.2...2.5	0.2...2.5	0.2...2.5	0.2...2.5
					Stripping length	mm		12
Screw driver	Flat screwdriver Ø		mm		3.5	3.5	3.5	3.5

Control circuit characteristics with AC/DC coils					LC1G115...225	LC1G265...330	LC1G400...500	LC1G630...800
Rated control circuit voltage (Uc)				V	48...130 AC/DC			
Control voltage limits (θ ≤ 60 °C)	AC input (50/60 Hz) /DC input	Operation			0.8 Uc Min...1.1 Uc Max			
		Drop-out			0.1 Uc Max...0.45 Uc Min			
Average consumption at 20 °C and at Uc (3 and 4-pole contactors)	48...130 V AC/DC coil (EHE)	Inrush	50/60 Hz coil	VA	640	780	965	990
			DC	W	445	695	760	790
		Sealed	50/60 Hz coil	VA	18.7	17.6	17.6	18.7
			DC	W	7.8	7.8	7.8	9.5
Heat dissipation				W	5...6	6...7	6...7	6...7
Operating time	Closing "C"			ms	40...70	40...70	40...70	40...70
	Opening "O"			ms	15...50	15...50	15...50	15...50
Mechanical durability at Uc		In millions of operating cycles (max)			8	8	8	5
Maximum operating rate at ambient temperature ≤ 60 °C	In operating cycles per hour	AC-1			300	300	300	300
		AC-3			500	500	500	500
		AC-4			150	150	60	60

Characteristics of auxiliary contact modules					
Mechanically linked contacts	Conforming to IEC 60947-5-1				Each contactor is equipped with 1 NO + 1 NC auxiliary contact block and they are mechanically linked mirror contacts
Mirror contact	Conforming to IEC 60947-4-1				The NC contact of the auxiliary contact block is mirror contact
Rated operational voltage (Ue)	AC-15	Up to		V	500
Rated operational voltage (Ue)	DC-13	Up to		V	440
Conventional thermal current (Ith)	For ambient temperature ≤ 60 °C			A	10

# TeSys Control

## TeSys Giga S207 - Contactors for railway applications

### Characteristics

Characteristics of auxiliary contact modules				
Number of auxiliary contact modules		Up to		4
Rated operational voltage (Ue)	AC-15	Up to	V	500
Rated operational voltage (Ue)	DC-13	Up to	V	440
Rated thermal current (Ith)	For ambient temperature ≤ 60 °C		A	10
Minimum load				1 mA at 17 V DC

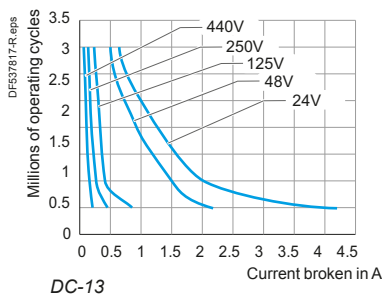
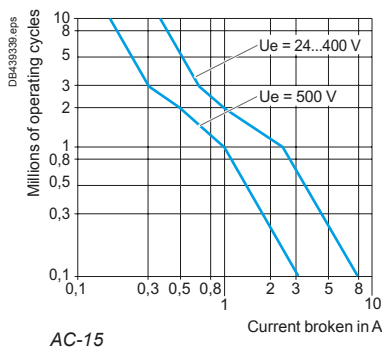

### Operational power of contacts conforming to IEC 60947-5-1 - Electrical durability

#### category AC-15

Operating cycles	V	24	48	115	230	400	500
1 million	VA	60	120	280	560	800	500
2 million	VA	24	48	115	230	400	250
3 million	VA	16	32	80	160	280	150

#### category DC-13

Operating cycles	V	24	48	125	250	440
0.5 million	W	100	100	105	110	88
1 million	W	48	72	54	54	55
2 million	W	24	36	38	38	39
3 million	W	16	24	25	25	33

### Connector characteristics

Push-in connection - Dual input			Min/max c.s.a.
Flexible cable per input	1 conductor with cable end	mm <sup>2</sup>	0.75...2.5
	2 conductors with Dual Sleeve	mm <sup>2</sup>	0.75...2.5
	Stripping length	mm <sup>2</sup>	10
Solid cable per input	1 conductor	mm <sup>2</sup>	0.75...2.5
	Stripping length	mm	12

# TeSys Control

## TeSys Giga S207 - Contactors for railway applications

### Dimensions

#### LC1G115...225

##### 3-pole

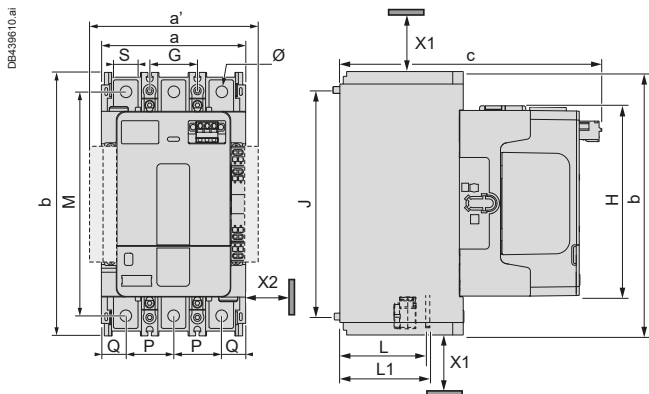

All dimensions are in mm.

a	b	c	G	J	M	H	L	L1	P	Q	S	Ø
107.7	193	192.9	35	166	164.1	139.4	66.9	69.9	35	18.9	18	8.5

X1 (mm) = Minimum electrical clearance.

LC1G115...800, up to 1000 V: 40 mm

X2 (mm) = Minimum electrical clearance according to operating voltage inside metallic cabinets / adjacent installation of contactors.

LC1G115...800: 5 mm.

a' = a + 20 mm with additional auxiliary contact blocks on both sides (externally).

##### 4-pole

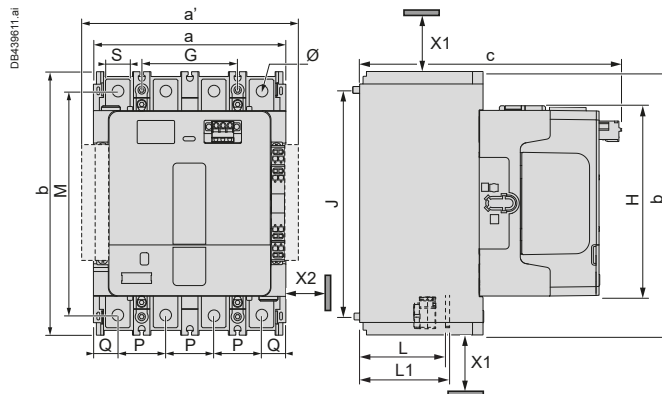

All dimensions are in mm.

a	b	c	G	J	M	H	L	L1	P	Q	S	Ø
142.7	193	192.9	35	166	164.1	139.4	66.9	69.9	35	18.9	18	8.5

#### LC1G265...500

##### 3-pole

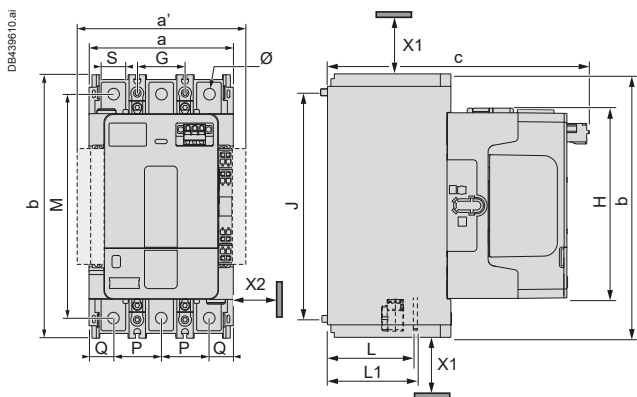

All dimensions are in mm.

a	b	c	G	J	M	H	L	L1
140	225	225.5	45	187	197	161.8	78.8	LC1G265-330: 81.8
								LC1G400: 82.8
								LC1G500: 83.8

P	Q	S	Ø
45	25	30	10.6

X1 (mm) = Minimum electrical clearance.

LC1G115...800, up to 1000 V: 40 mm.

X2 (mm) = Minimum electrical clearance according to operating voltage inside metallic cabinets / adjacent installation of contactors.

LC1G115...800: 5 mm.

a' = a + 20 mm with additional auxiliary contact blocks on both sides (externally).

##### 4-pole

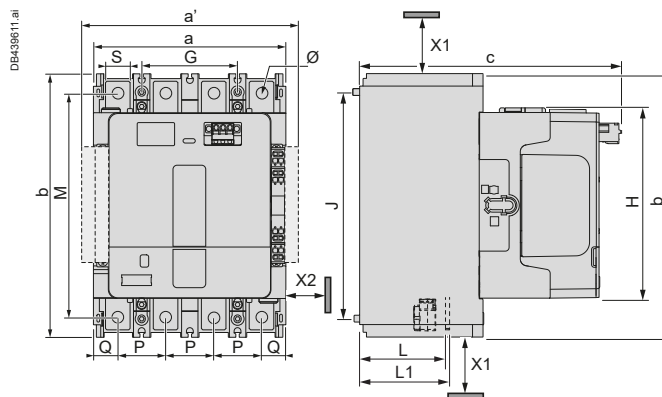

All dimensions are in mm.

a	b	c	G	J	M	H	L	L1
185	225	225.5	45	187	197	161.8	78.8	LC1G265-330: 81.8
								LC1G400: 82.8
								LC1G500: 83.8

P	Q	S	Ø
45	25	30	10.6

# TeSys Control

## TeSys Giga S207 - Contactors for railway applications

### Dimensions and schemes

#### LC1G630...800

3-pole

4-pole

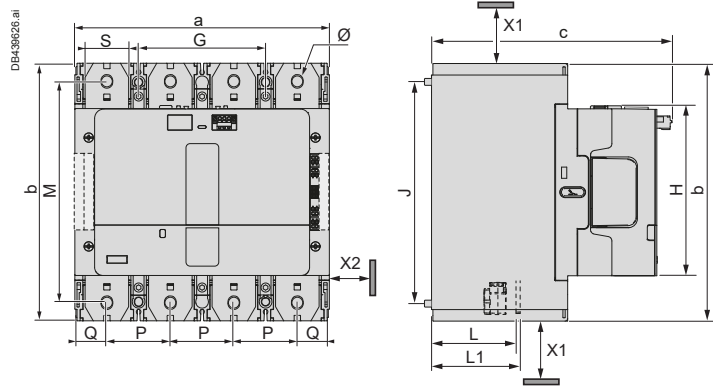
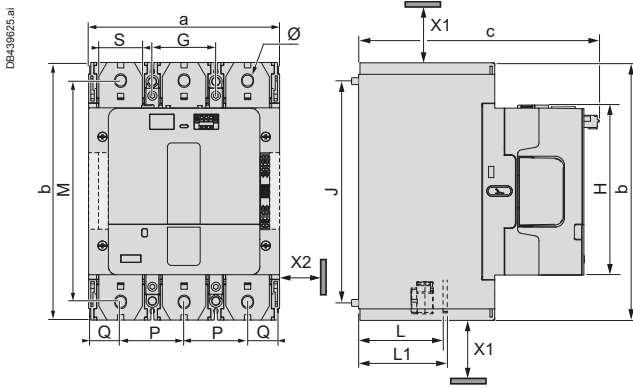

All dimensions are in mm.

a	b	c	G	J	M	H	L	L1	P	Q	S	Ø
210.6	284	265.6	70	242	244	187.4	107	113	70	35.3	48	13

All dimensions are in mm.

a	b	c	G	J	M	H	L	L1	P	Q	S	Ø
280.6	284	265.6	70	242	244	187.4	107	113	70	35.3	48	13

X1 (mm) = Minimum electrical clearance.

LC1G115...800, up to 1000 V: 40 mm.

X2 (mm) = Minimum electrical clearance according to operating voltage inside metallic cabinets / adjacent installation of contactors.

LC1G115...800: 5 mm.

#### Contactors

3-pole or 4-pole contactors

LC1G115...G800

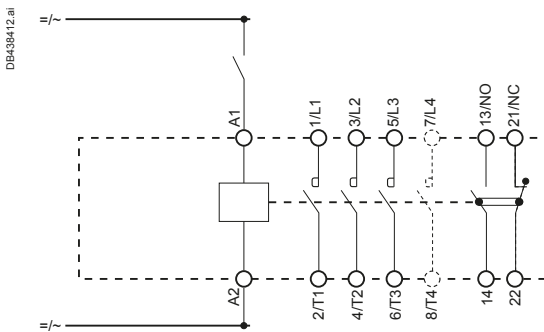

#### Add-on blocks

Instantaneous auxiliary contacts

1 N/O + 1 N/C

2 N/O

1 N/O + 1 N/C

2 N/O

LAG8N113P  
mirror contacts

LAG8N203P

LAG8N113  
mirror contacts

LAG8N203

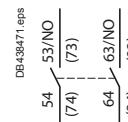
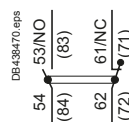
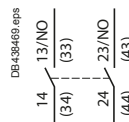
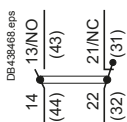

**Note:** Terminal numbers in brackets refer to blocks when mounted upside down, on left-hand side of contactor.





# Green Premium™

An industry leading portfolio of offers delivering sustainable value



More than 75% of our product sales offer superior transparency on the material content, regulatory information and environmental impact of our products:

- RoHS compliance
- REACH substance information
- Industry leading # of PEP's\*
- Circularity instructions
- Sustainable packaging



Discover what we mean by green  
**Check your products!**

The Green Premium program stands for our commitment to deliver customer valued sustainable performance. It has been upgraded with recognized environmental claims and extended to cover all offers including Products, Services and Solutions.

#### CO<sub>2</sub> and P&L impact through... Resource Performance

Green Premium brings improved resource efficiency throughout an asset's lifecycle. This includes efficient use of energy and natural resources, along with the minimization of CO<sub>2</sub> emissions.

#### Cost of ownership optimization through... Circular Performance

We're helping our customers optimize the total cost of ownership of their assets. To do this, we provide IoT-enabled solutions, as well as upgrade, repair, retrofit, and remanufacture services.

#### Peace of mind through... Well-being Performance

Green Premium products are RoHS and REACH compliant. We're going beyond regulatory compliance with step-by-step substitution of certain materials and substances from our products.

#### Improved sales through... Differentiation

Green Premium delivers strong value propositions through third-party labels and services. By collaborating with third-party organizations we can support our customers in meeting their sustainability goals such as green building certifications.

\*PEP: Product Environmental Profile (i.e. Environmental Product Declaration)



Life Is On | **Schneider**  
Electric

**Schneider Electric Industries SAS**

35, rue Joseph Monier  
CS 30323  
92506 Rueil Malmaison Cedex  
France

RCS Nanterre 954 503 439  
Capital social 896 313 776 €  
[www.schneider-electric.com](http://www.schneider-electric.com)

September, 2022

