

PolarP™ Power MOSFET

IXTR170P10P

$V_{DSS} = -100V$
 $I_{D25} = -100A$
 $R_{DS(on)} \leq 15.4m\Omega$

P-Channel Enhancement Mode
Avalanche Rated

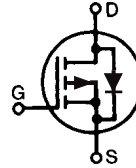

ISOPLUS247
E153432

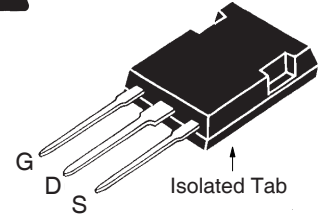

G = Gate D = Drain
S = Source

Symbol	Test Conditions	Maximum Ratings	
V_{DSS}	$T_J = 25^\circ C$ to $150^\circ C$	-100	V
V_{DGR}	$T_J = 25^\circ C$ to $150^\circ C$, $R_{GS} = 1M\Omega$	-100	V
V_{GSS}	Continuous	± 20	V
V_{GSM}	Transient	± 30	V
I_{D25}	$T_C = 25^\circ C$	-100	A
I_{DM}	$T_C = 25^\circ C$, Pulse Width Limited by T_{JM}	- 510	A
I_A	$T_C = 25^\circ C$	-170	A
E_{AS}	$T_C = 25^\circ C$	3.5	J
dv/dt	$I_S \leq I_{DM}$, $V_{DD} \leq V_{DSS}$, $T_J \leq 150^\circ C$	10	V/ns
P_D	$T_C = 25^\circ C$	312	W
T_J		-55 ... +150	$^\circ C$
T_{JM}		150	$^\circ C$
T_{stg}		-55 ... +150	$^\circ C$
T_L	Maximum Lead Temperature for Soldering	300	$^\circ C$
T_{SOLD}	1.6 mm (0.062in.) from Case for 10s	260	$^\circ C$
V_{ISOL}	50/60 Hz, RMS, t= 1min	2500	V~
M_d	Mounting Force	20..120/4.5..27	N/lb.
Weight		5	g

Features

- Silicon Chip on Direct-Copper Bond (DCB) Substrate
 - UL Recognized Package
 - Isolated Mounting Surface
 - 2500V Electrical Isolation
- Dynamic dv/dt Rating
- High Current Handling Capability
- Avalanche Rated
- Fast Intrinsic Diode
- The Rugged PolarP™ Process
- Low Q_g
- Low Drain-to-Tab Capacitance
- Low Package Inductance

Advantages

- Easy to Mount
- Space Savings
- High Power Density

Applications

- High-Side Switches
- Push Pull Amplifiers
- DC Choppers
- Automatic Test Equipment
- Current Regulators

Symbol	Test Conditions ($T_J = 25^\circ C$, Unless Otherwise Specified)	Characteristic Values		
		Min.	Typ.	Max.
BV_{DSS}	$V_{GS} = 0V$, $I_D = -250\mu A$	-100		V
$V_{GS(th)}$	$V_{DS} = V_{GS}$, $I_D = -1mA$	- 2.0		V
I_{GSS}	$V_{GS} = \pm 20V$, $V_{DS} = 0V$			± 100 nA
I_{DSS}	$V_{DS} = V_{DSS}$, $V_{GS} = 0V$ $T_J = 125^\circ C$			- 50 μA - 250 μA
$R_{DS(on)}$	$V_{GS} = -10V$, $I_D = -85A$, Note 1			15.4 m Ω

Symbol	Test Conditions ($T_J = 25^\circ\text{C}$, Unless Otherwise Specified)	Characteristic Values		
		Min.	Typ.	Max.
g_{fs}	$V_{DS} = -10\text{V}$, $I_D = -85\text{A}$, Note 1	35	58	S
C_{iss}	$V_{GS} = 0\text{V}$, $V_{DS} = -25\text{V}$, $f = 1\text{MHz}$		12.6	nF
C_{oss}			4190	pF
C_{rss}			930	pF
$t_{d(on)}$	Resistive Switching Times $V_{GS} = -10\text{V}$, $V_{DS} = 0.5 \cdot V_{DSS}$, $I_D = -85\text{A}$ $R_G = 1\Omega$ (External)		32	ns
t_r			75	ns
$t_{d(off)}$			82	ns
t_f			45	ns
$Q_{g(on)}$	$V_{GS} = -10\text{V}$, $V_{DS} = 0.5 \cdot V_{DSS}$, $I_D = -85\text{A}$		240	nC
Q_{gs}			45	nC
Q_{gd}			120	nC
R_{thJC}				0.40 $^\circ\text{C/W}$
R_{thCS}		0.15		$^\circ\text{C/W}$

Source-Drain Diode

Symbol	Test Conditions ($T_J = 25^\circ\text{C}$, Unless Otherwise Specified)	Characteristic Values		
		Min.	Typ.	Max.
I_s	$V_{GS} = 0\text{V}$			-170 A
I_{SM}	Repetitive, Pulse Width Limited by T_{JM}			-680 A
V_{SD}	$I_F = -85\text{A}$, $V_{GS} = 0\text{V}$, Note 1			-3.3 V
t_{rr}	$I_F = -85\text{A}$, $-di/dt = -100\text{A}/\mu\text{s}$ $V_R = -50\text{V}$, $V_{GS} = 0\text{V}$		176	ns
Q_{RM}			1.25	μC
I_{RM}			-14.2	A

Note 1: Pulse Test, $t \leq 300\mu\text{s}$; Duty Cycle, $d \leq 2\%$.

ISOPLUS247 (IXTR) Outline

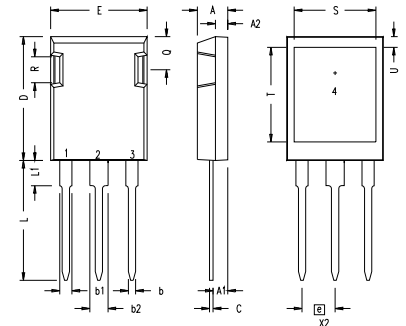

1 - Gate
2,4 - Drain
3 - Source

SYM	INCHES		MILLIMETERS	
	MIN	MAX	MIN	MAX
A	.190	.205	4.83	5.21
A1	.090	.100	2.29	2.54
A2	.075	.085	1.91	2.16
b	.045	.055	1.14	1.40
b1	.075	.084	1.91	2.13
b2	.115	.123	2.92	3.12
C	.024	.031	0.61	0.80
D	.819	.840	20.80	21.34
E	.620	.635	15.75	16.13
e	.215 BSC		5.45 BSC	
L	.780	.800	19.81	20.32
L1	.150	.170	3.81	4.32
Q	.220	.244	5.59	6.20
R	.170	.190	4.32	4.83
S	.520	.540	13.21	13.72
T	.620	.640	15.75	16.26
U	.065	.080	1.65	2.03

IXYS Reserves the Right to Change Limits, Test Conditions, and Dimensions.

IXYS MOSFETs and IGBTs are covered by one or more of the following U.S. patents:

4,835,592	4,931,844	5,049,961	5,237,481	6,162,665	6,404,065 B1	6,683,344	6,727,585	7,005,734 B2	7,157,338B2
4,860,072	5,017,508	5,063,307	5,381,025	6,259,123 B1	6,534,343	6,710,405 B2	6,759,692	7,063,975 B2	
4,881,106	5,034,796	5,187,117	5,486,715	6,306,728 B1	6,583,505	6,710,463	6,771,478 B2	7,071,537	

Fig. 1. Output Characteristics @ $T_J = 25^\circ\text{C}$

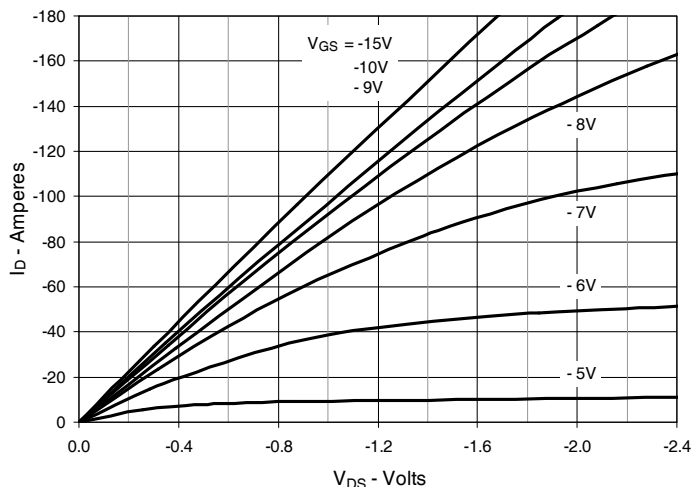

Fig. 2. Extended Output Characteristics @ $T_J = 25^\circ\text{C}$

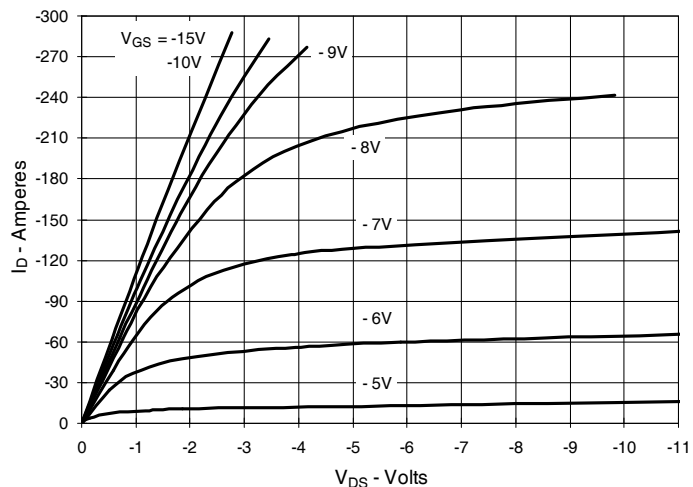

Fig. 3. Output Characteristics @ $T_J = 125^\circ\text{C}$

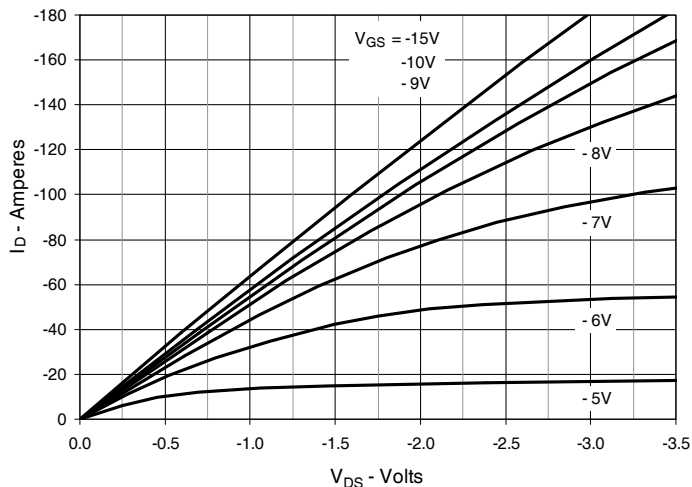

Fig. 4. $R_{DS(on)}$ Normalized to $I_D = -85\text{A}$ Value vs. Junction Temperature

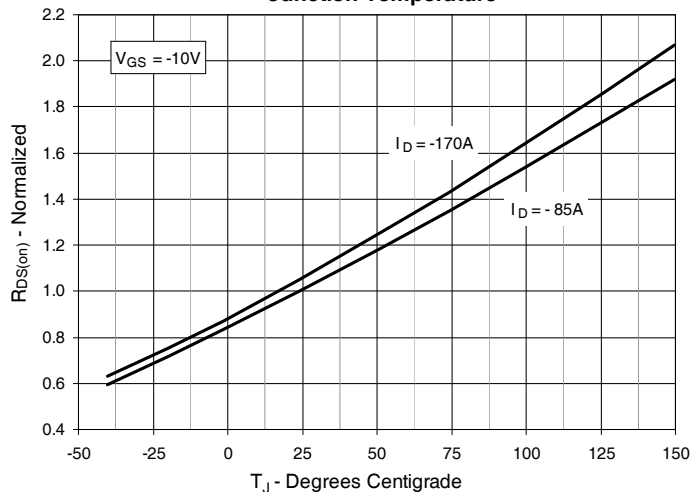

Fig. 5. $R_{DS(on)}$ Normalized to $I_D = -85\text{A}$ Value vs. Drain Current

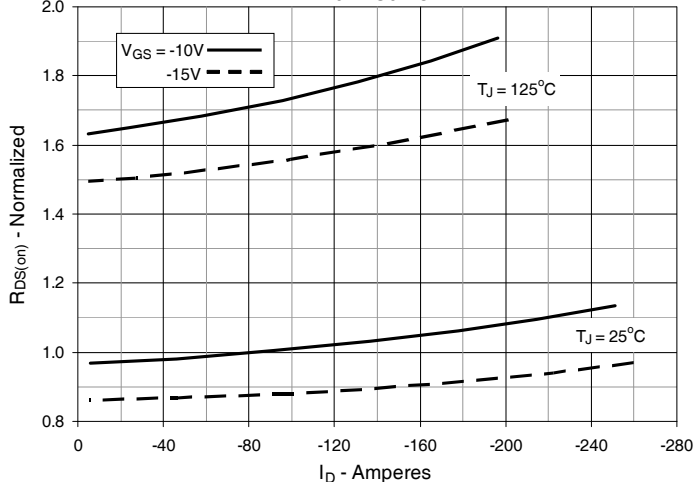

Fig. 6. Maximum Drain Current vs. Case Temperature

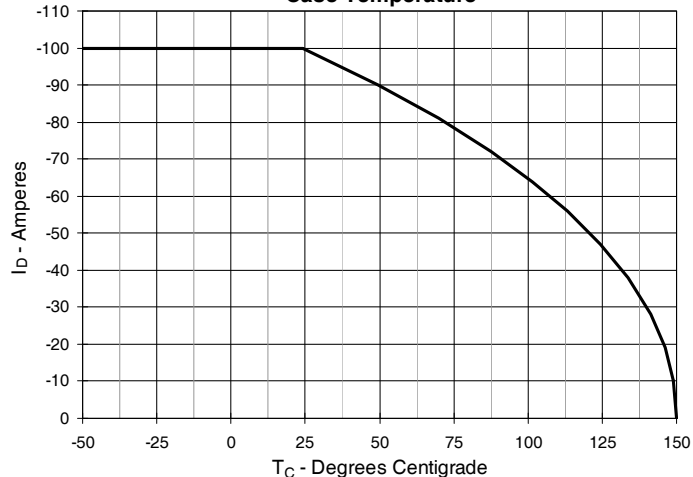

Fig. 7. Input Admittance

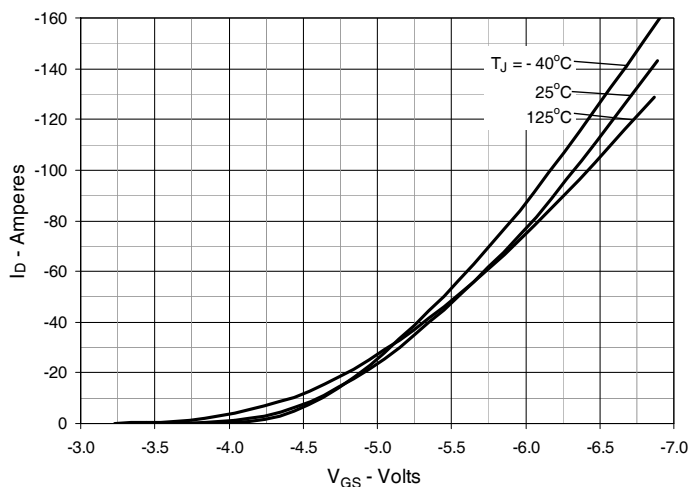

Fig. 8. Transconductance

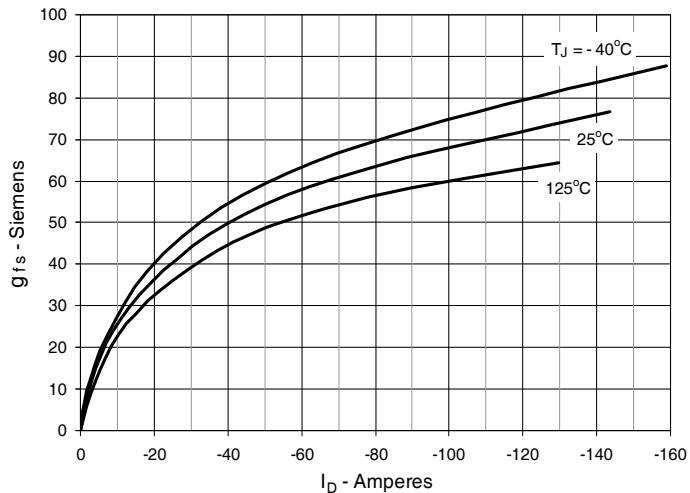

Fig. 9. Forward Voltage Drop of Intrinsic Diode

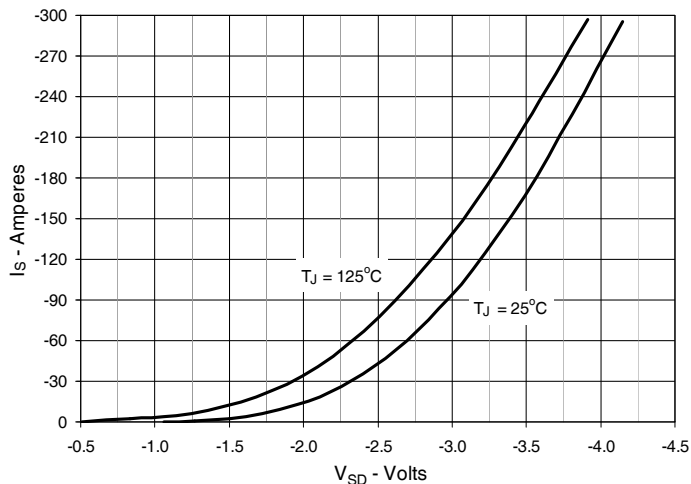

Fig. 10. Gate Charge

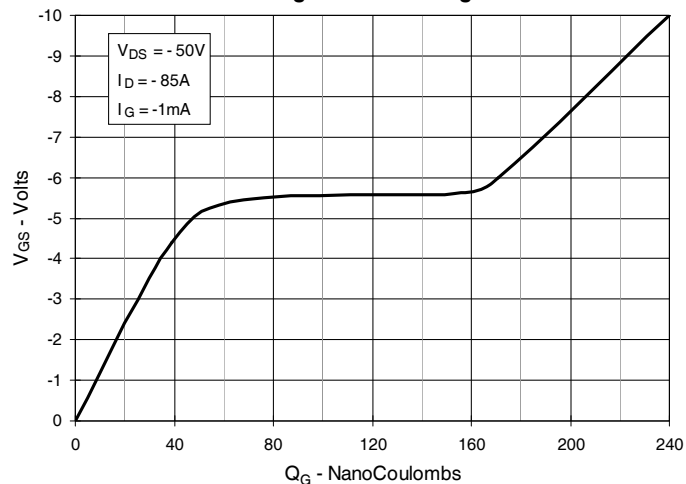

Fig. 11. Capacitance

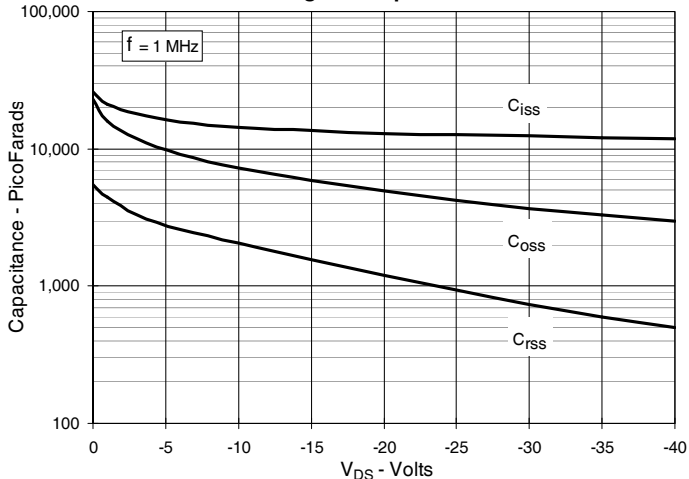

Fig. 12. Forward-Bias Safe Operating Area

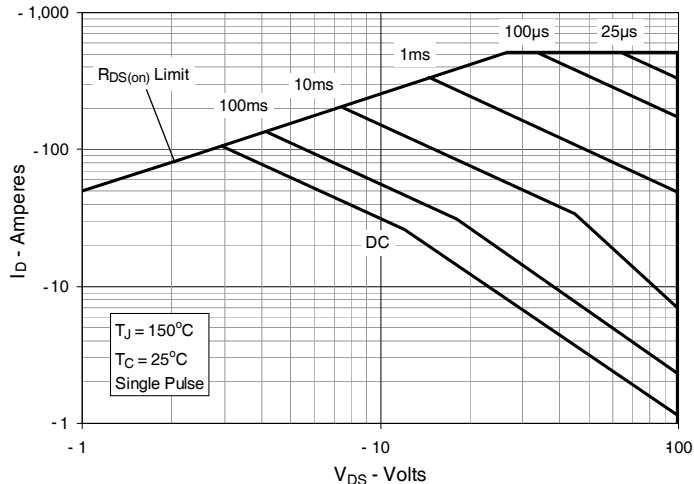

Fig. 13. Maximum Transient Thermal Impedance

