

**TrenchP™**  
**Power MOSFETs**

**IXTA96P085T**  
**IXTP96P085T**  
**IXTH96P085T**

$V_{DSS} = -85V$   
 $I_{D25} = -96A$   
 $R_{DS(on)} \leq 13m\Omega$

P-Channel Enhancement Mode  
Avalanche Rated

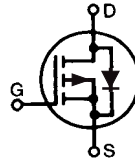

| Symbol        | Test Conditions   | Maximum Ratings |            |
|---------------|---|-----------------|------------|
| $V_{DSS}$     | $T_J = 25^\circ C$ to $150^\circ C$                       | - 85            | V          |
| $V_{DGR}$     | $T_J = 25^\circ C$ to $150^\circ C$ , $R_{GS} = 1M\Omega$ | - 85            | V          |
| $V_{GSS}$     | Continuous  | $\pm 15$        | V          |
| $V_{GSM}$     | Transient   | $\pm 25$        | V          |
| $I_{D25}$     | $T_C = 25^\circ C$  | - 96            | A          |
| $I_{DM}$      | $T_C = 25^\circ C$ , Pulse Width Limited by $T_{JM}$      | - 300           | A          |
| $I_A$         | $T_C = 25^\circ C$  | - 48            | A          |
| $E_{AS}$      | $T_C = 25^\circ C$  | 1               | J          |
| $P_D$         | $T_C = 25^\circ C$  | 298             | W          |
| $T_J$         |   | -55 ... +150    | $^\circ C$ |
| $T_{JM}$      |   | 150             | $^\circ C$ |
| $T_{stg}$     |   | -55 ... +150    | $^\circ C$ |
| $T_L$         | 1.6mm (0.062 in.) from Case for 10s                       | 300             | $^\circ C$ |
| $T_{sOLD}$    | Plastic Body for 10s                                      | 260             | $^\circ C$ |
| $M_d$         | Mounting Torque (TO-220 & TO-247)                         | 1.13/10         | Nm/lb.in.  |
| <b>Weight</b> | TO-263  | 2.5             | g          |
|               | TO-220  | 3.0             | g          |
|               | TO-247  | 6.0             | g          |

| Symbol       | Test Conditions<br>( $T_J = 25^\circ C$ , Unless Otherwise Specified) | Characteristic Values |      |                               |
|--------------|---|-----------------------|------|-------------------------------|
|              |   | Min.                  | Typ. | Max.                          |
| $BV_{DSS}$   | $V_{GS} = 0V$ , $I_D = -250\mu A$                                     | - 85                  |      | V                             |
| $V_{GS(th)}$ | $V_{DS} = V_{GS}$ , $I_D = -250\mu A$                                 | - 2.0                 |      | - 4.0 V                       |
| $I_{GSS}$    | $V_{GS} = \pm 15V$ , $V_{DS} = 0V$                                    |                       |      | $\pm 100$ nA                  |
| $I_{DSS}$    | $V_{DS} = V_{DSS}$ , $V_{GS} = 0V$<br>$T_J = 125^\circ C$             |                       |      | - 10 $\mu A$<br>- 750 $\mu A$ |
| $R_{DS(on)}$ | $V_{GS} = -10V$ , $I_D = 0.5 \cdot I_{D25}$ , Note 1                  |                       |      | 13 m $\Omega$                 |

TO-263 AA (IXTA)

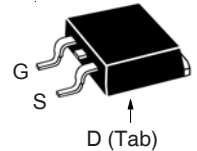

TO-220AB (IXTP)

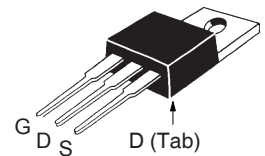

TO-247 (IXTH)

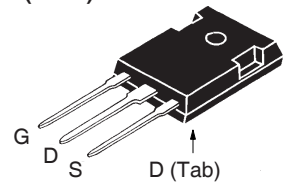

G = Gate      D = Drain  
S = Source    Tab = Drain

**Features**

- International Standard Packages
- Avalanche Rated
- Extended FBSOA
- Fast Intrinsic Diode
- Low  $R_{DS(ON)}$  and  $Q_G$

**Advantages**

- Easy to Mount
- Space Savings
- High Power Density

**Applications**

- High-Side Switching
- Push Pull Amplifiers
- DC Choppers
- Automatic Test Equipment
- Current Regulators
- Battery Charger Applications

| Symbol       | Test Conditions<br>( $T_J = 25^\circ\text{C}$ , Unless Otherwise Specified)   | Characteristic Values |      |                    |
|--------------|---|-----------------------|------|--------------------|
|              |   | Min.                  | Typ. | Max.               |
| $g_{fs}$     | $V_{DS} = -10\text{V}$ , $I_D = 0.5 \cdot I_{D25}$ , Note 1   | 40                    | 66   | S                  |
| $C_{iss}$    | $V_{GS} = 0\text{V}$ , $V_{DS} = -25\text{V}$ , $f = 1\text{MHz}$   |                       | 13.1 | nF                 |
| $C_{oss}$    |   |                       | 1175 | pF                 |
| $C_{rss}$    |   |                       | 460  | pF                 |
| $t_{d(on)}$  | <b>Resistive Switching Times</b><br>$V_{GS} = -10\text{V}$ , $V_{DS} = 0.5 \cdot V_{DSS}$ , $I_D = 0.5 \cdot I_{D25}$<br>$R_G = 1\Omega$ (External) |                       | 23   | ns                 |
| $t_r$        |   |                       | 34   | ns                 |
| $t_{d(off)}$ |   |                       | 45   | ns                 |
| $t_f$        |   |                       | 22   | ns                 |
| $Q_{g(on)}$  | $V_{GS} = -10\text{V}$ , $V_{DS} = 0.5 \cdot V_{DSS}$ , $I_D = 0.5 \cdot I_{D25}$   |                       | 180  | nC                 |
| $Q_{gs}$     |   |                       | 52   | nC                 |
| $Q_{gd}$     |   |                       | 62   | nC                 |
| $R_{thJC}$   |   |                       | 0.42 | $^\circ\text{C/W}$ |
| $R_{thCS}$   | TO-220  | 0.50                  |      | $^\circ\text{C/W}$ |
|              | TO-247  | 0.21                  |      | $^\circ\text{C/W}$ |

### Source-Drain Diode

| Symbol   | Test Conditions<br>( $T_J = 25^\circ\text{C}$ , Unless Otherwise Specified)                             | Characteristic Values |      |        |
|----------|---|-----------------------|------|--------|
|          |   | Min.                  | Typ. | Max.   |
| $I_S$    | $V_{GS} = 0\text{V}$  |                       |      | -96 A  |
| $I_{SM}$ | Repetitive, Pulse Width Limited by $T_{JM}$   |                       |      | -394 A |
| $V_{SD}$ | $I_F = -48\text{A}$ , $V_{GS} = 0\text{V}$ , Note 1   |                       |      | -1.3 V |
| $t_{rr}$ | $I_F = -48\text{A}$ , $-di/dt = -100\text{A}/\mu\text{s}$<br>$V_R = -43\text{V}$ , $V_{GS} = 0\text{V}$ |                       | 55   | ns     |
| $Q_{RM}$ |   |                       | 100  | nC     |
| $I_{RM}$ |   |                       | -3.6 | A      |

Note 1. Pulse test,  $t \leq 300\mu\text{s}$ , duty cycle,  $d \leq 2\%$ .

### TO-263 Outline

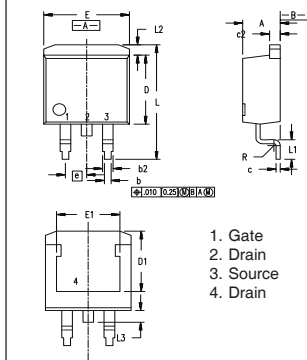

| Dim. | Millimeter |       | Inches |      |
|------|------------|-------|--------|------|
|      | Min.       | Max.  | Min.   | Max. |
| A    | 4.06       | 4.83  | .160   | .190 |
| b    | 0.51       | 0.99  | .020   | .039 |
| b2   | 1.14       | 1.40  | .045   | .055 |
| c    | 0.40       | 0.74  | .016   | .029 |
| c2   | 1.14       | 1.40  | .045   | .055 |
| D    | 8.64       | 9.65  | .340   | .380 |
| D1   | 8.00       | 8.89  | .280   | .320 |
| E    | 9.65       | 10.41 | .380   | .405 |
| E1   | 6.22       | 8.13  | .270   | .320 |
| e    | 2.54       | BSC   | .100   | BSC  |
| L    | 14.61      | 15.88 | .575   | .625 |
| L1   | 2.29       | 2.79  | .090   | .110 |
| L2   | 1.02       | 1.40  | .040   | .055 |
| L3   | 1.27       | 1.78  | .050   | .070 |
| L4   | 0          | 0.13  | 0      | .005 |

1. Gate
2. Drain
3. Source
4. Drain

### TO-247 Outline

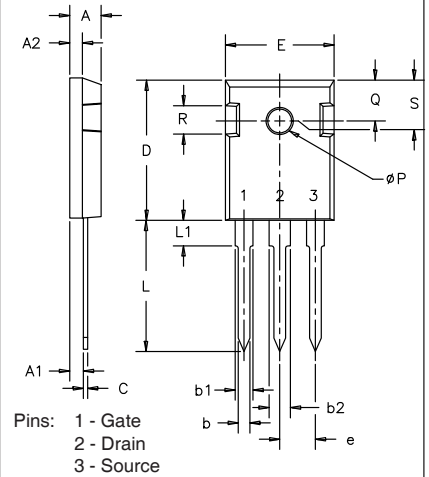

| SYM      | INCHES |      | MILLIMETERS |       |
|----------|--------|------|-------------|-------|
|          | MIN    | MAX  | MIN         | MAX   |
| A        | .185   | .209 | 4.7         | 5.3   |
| A1       | .087   | .102 | 2.2         | 2.54  |
| A2       | .059   | .098 | 2.2         | 2.6   |
| b        | .040   | .055 | 1.0         | 1.4   |
| b1       | .065   | .084 | 1.65        | 2.13  |
| b2       | .113   | .123 | 2.87        | 3.12  |
| C        | .016   | .031 | .4          | .8    |
| D        | .819   | .845 | 20.80       | 21.46 |
| E        | .610   | .640 | 15.75       | 16.26 |
| e        | .215   | BSC  | 5.45        | BSC   |
| L        | .780   | .800 | 19.81       | 20.32 |
| L1       |        | .177 |             | 4.50  |
| $\phi P$ | .140   | .144 | 3.55        | 3.65  |
| Q        | .212   | .244 | 5.4         | 6.2   |
| R        | .170   | .216 | 4.32        | 5.49  |
| S        | .242   | BSC  | 6.15        | BSC   |

### TO-220 Outline

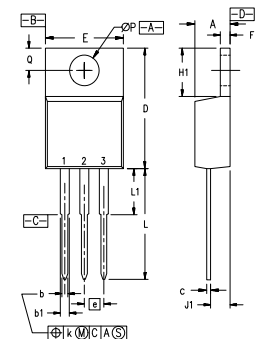

- 1 - Gate
- 2 - Drain
- 3 - Source

| SYM      | INCHES |      | MILLIMETERS |       |
|----------|--------|------|-------------|-------|
|          | MIN    | MAX  | MIN         | MAX   |
| A        | .170   | .190 | 4.32        | 4.83  |
| b        | .025   | .040 | 0.64        | 1.02  |
| b1       | .045   | .065 | 1.15        | 1.65  |
| c        | .014   | .022 | 0.35        | 0.56  |
| D        | .580   | .630 | 14.73       | 16.00 |
| E        | .390   | .420 | 9.91        | 10.66 |
| e        | .100   | BSC  | 2.54        | BSC   |
| F        | .045   | .055 | 1.14        | 1.40  |
| H1       | .230   | .270 | 5.85        | 6.85  |
| J1       | .090   | .110 | 2.29        | 2.79  |
| k        | 0      | .015 | 0           | 0.38  |
| L        | .500   | .550 | 12.70       | 13.97 |
| L1       | .110   | .230 | 2.79        | 5.84  |
| $\phi P$ | .139   | .161 | 3.53        | 4.08  |
| Q        | .100   | .125 | 2.54        | 3.18  |

IXYS Reserves The Right to Change Limits, Test Conditions, and Dimensions.

IXYS MOSFETs and IGBTs are covered 4,835,592 4,931,844 5,049,961 5,237,481 6,162,665 6,404,065 B1 6,683,344 6,727,585 7,005,734 B2 7,157,338B2  
by one or more of the following U.S. patents: 4,860,072 5,017,508 5,063,307 5,381,025 6,259,123 B1 6,534,343 6,710,405 B2 6,759,692 7,063,975 B2  
4,881,106 5,034,796 5,187,117 5,486,715 6,306,728 B1 6,583,505 6,710,463 6,771,478 B2 7,071,537

Fig. 1. Output Characteristics @  $T_J = 25^\circ\text{C}$

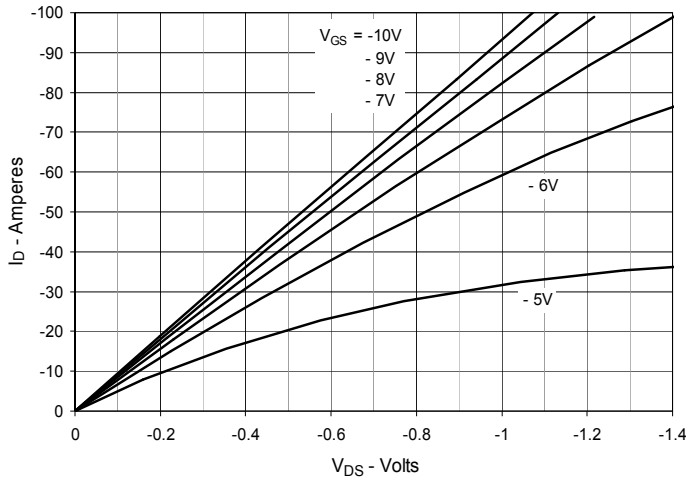

Fig. 2. Extended Output Characteristics @  $T_J = 25^\circ\text{C}$

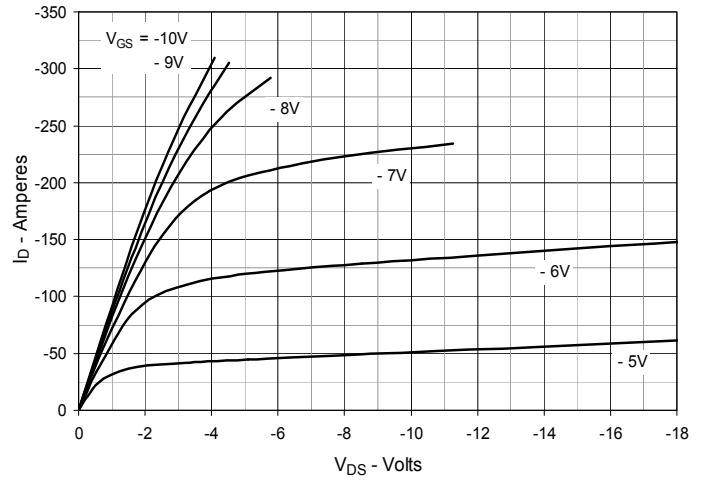

Fig. 3. Output Characteristics @  $T_J = 125^\circ\text{C}$

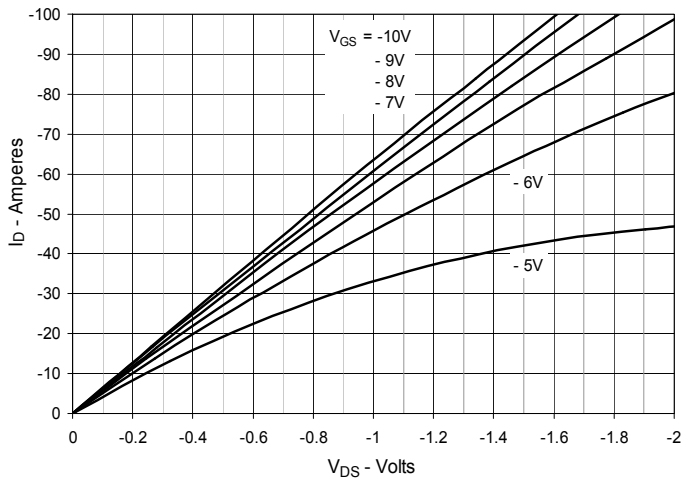

Fig. 4.  $R_{DS(on)}$  Normalized to  $I_D = -48\text{A}$  Value vs. Junction Temperature

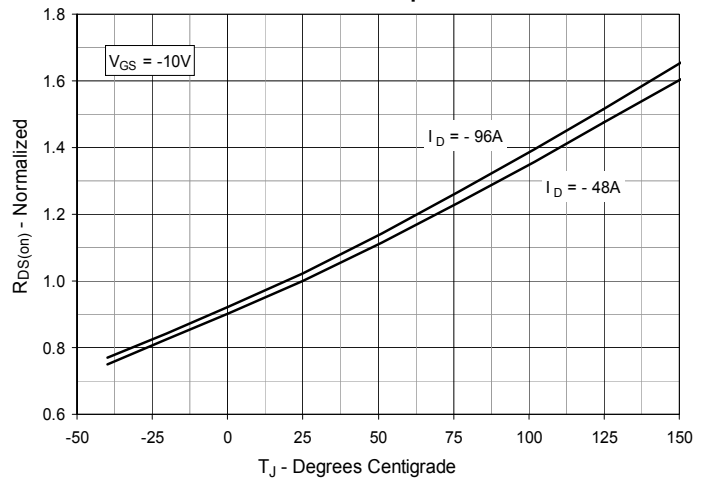

Fig. 5.  $R_{DS(on)}$  Normalized to  $I_D = -48\text{A}$  Value vs. Drain Current

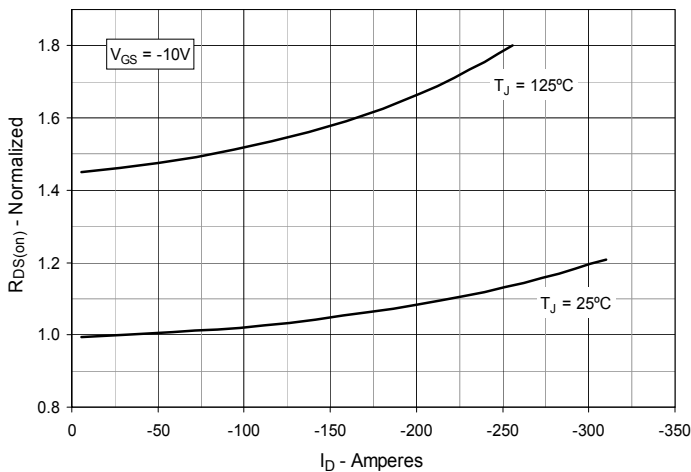

Fig. 6. Maximum Drain Current vs. Case Temperature

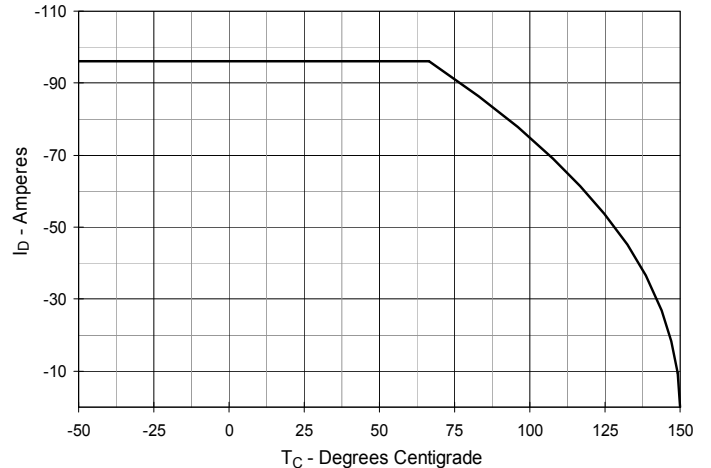

Fig. 7. Input Admittance

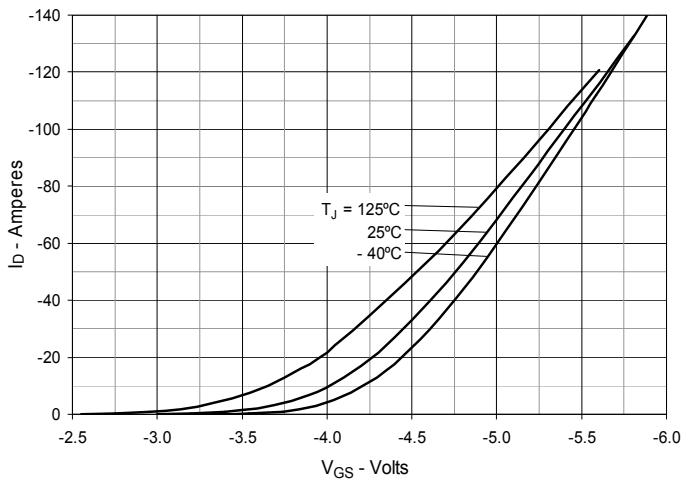

Fig. 8. Transconductance

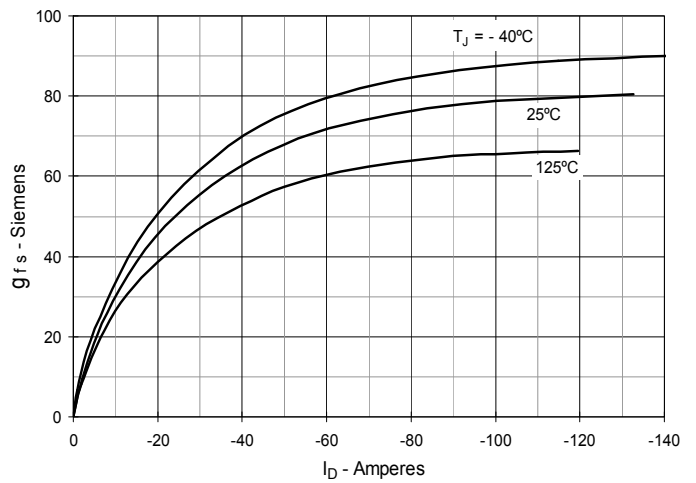

Fig. 9. Forward Voltage Drop of Intrinsic Diode

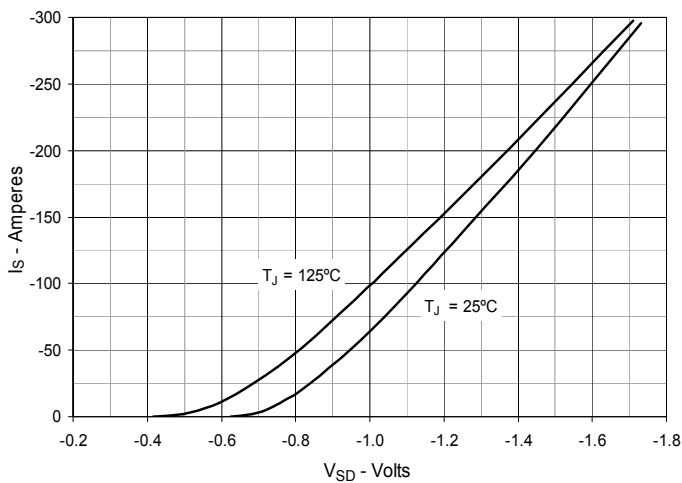

Fig. 10. Gate Charge

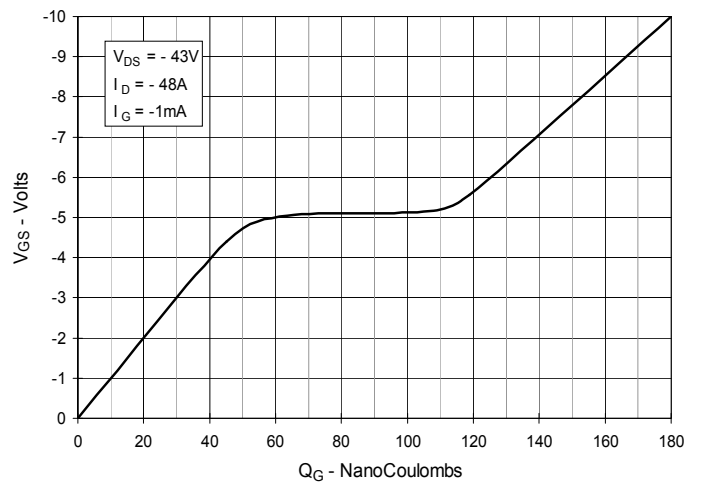

Fig. 11. Capacitance

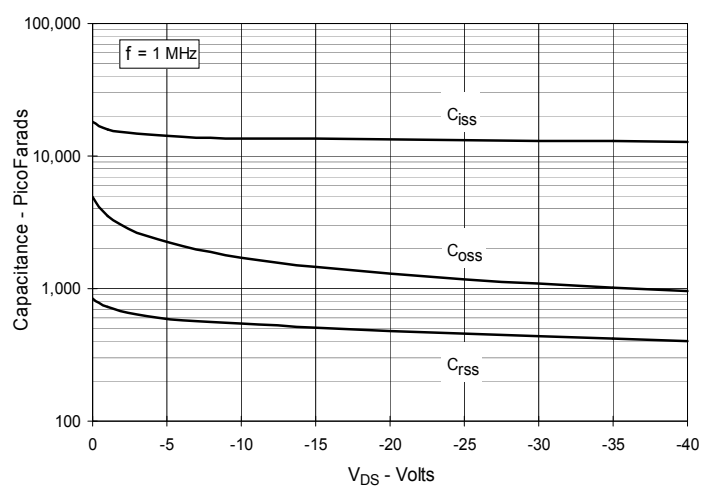
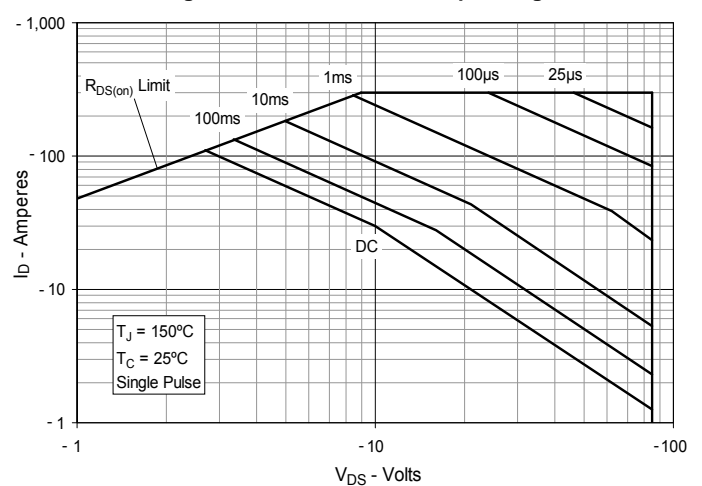
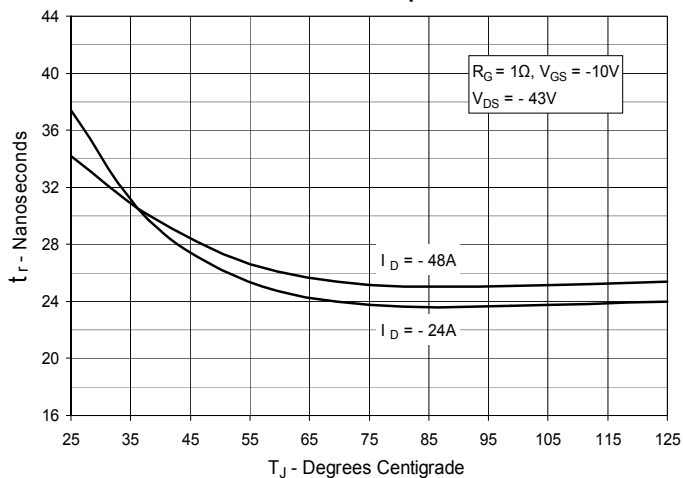

Fig. 12. Forward-Bias Safe Operating Area



**Fig. 13. Resistive Turn-on Rise Time vs. Junction Temperature**



**Fig. 14. Resistive Turn-on Rise Time vs. Drain Current**

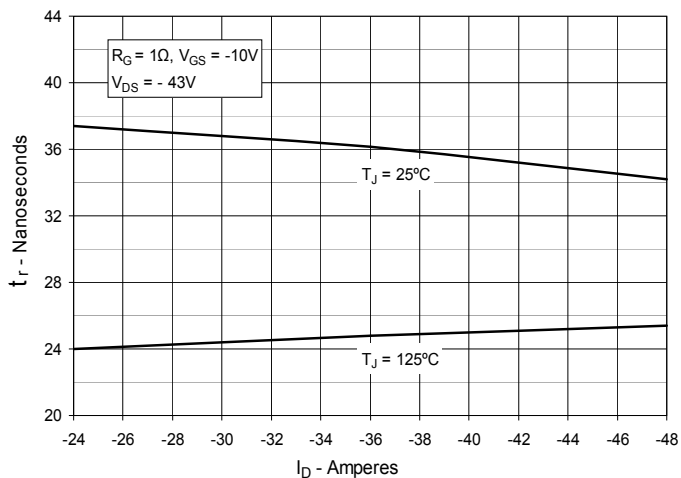

**Fig. 15. Resistive Turn-on Switching Times vs. Gate Resistance**

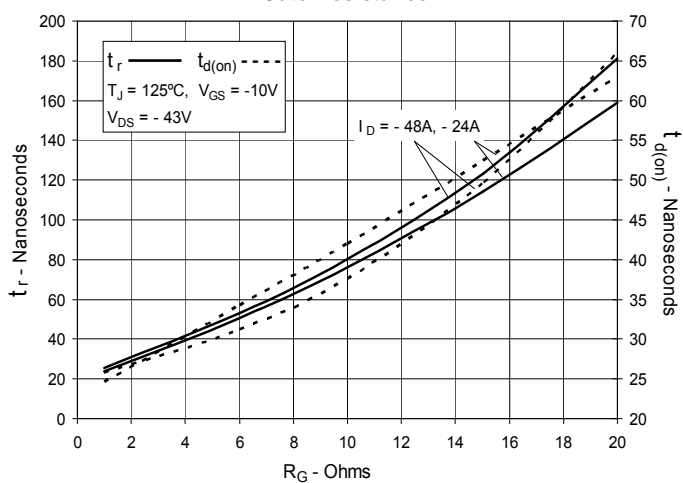

**Fig. 16. Resistive Turn-off Switching Times vs. Junction Temperature**

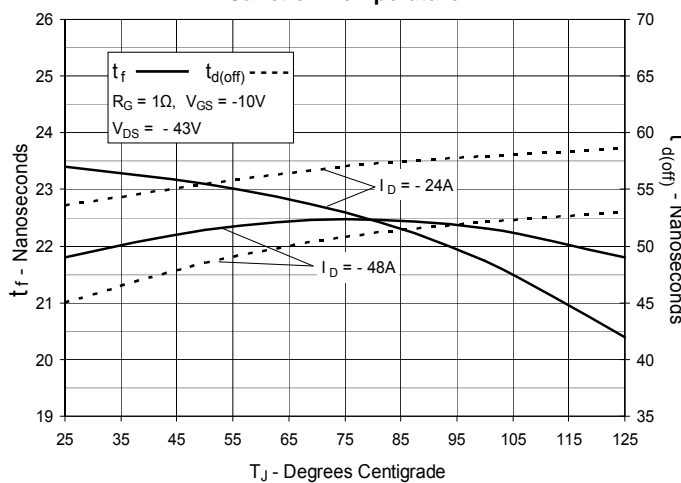

**Fig. 17. Resistive Turn-off Switching Times vs. Drain Current**

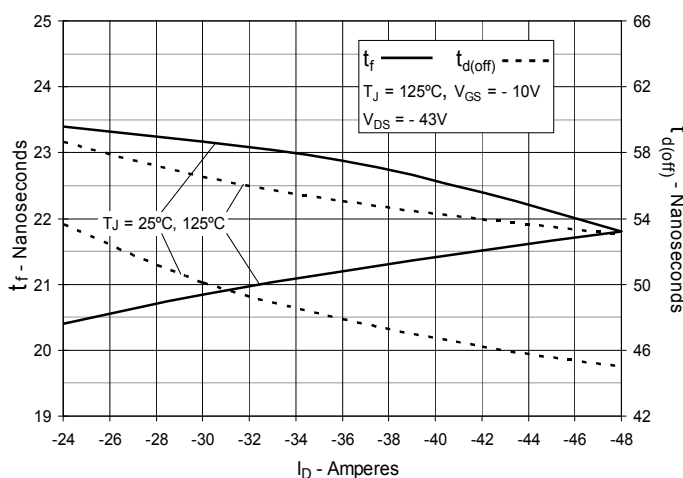

**Fig. 18. Resistive Turn-off Switching Times vs. Gate Resistance**

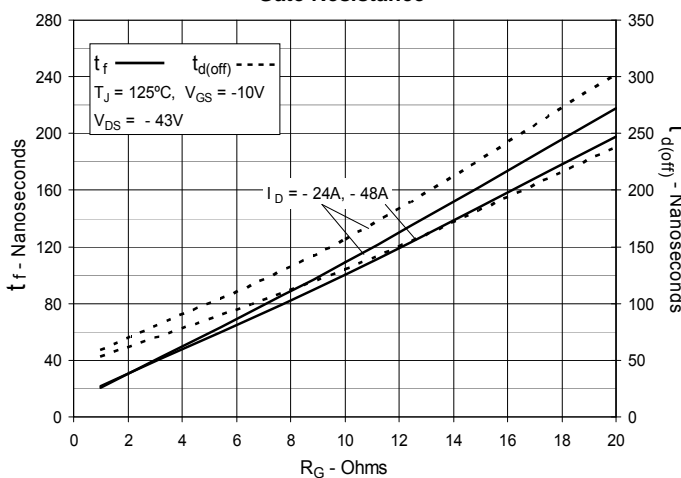

**Fig. 19. Maximum Transient Thermal Impedance**

