

# Breakover Diode Gen<sup>2</sup> (BOD2)

$$V_{BO} = 400-1400 \text{ V}$$

$$I_{AVM} = 0.9 \text{ A}$$

$V_{BO}$ [V]	Standard Types
400 ±50	IXBOD2-04
500 ±50	IXBOD2-05
600 ±50	IXBOD2-06
700 ±50	IXBOD2-07
800 ±50	IXBOD2-08
900 ±50	IXBOD2-09
1000 ±50	IXBOD2-10
1100 ±50	IXBOD2-11
1200 ±50	IXBOD2-12
1300 ±50	IXBOD2-13
1400 ±50	IXBOD2-14

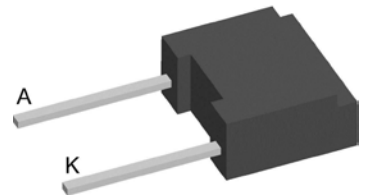

Backside: isolated

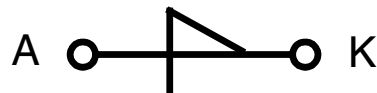

### Features / Advantages:

- Extra fast turn-on
- Very low temperature dependence

### Applications:

- High voltage circuit protection
- Transient voltage protection
- Trigger device
- Power pulse generators
- Lightning and arcing protection
- Energy discharge circuits
- Battery overvoltage protection
- Solar array protection

### Package: FP-Case

- Industry standard outline
- RoHS compliant
- Epoxy meets UL 94V-0
- Soldering pins for PCB mounting
- Base plate: Plastic overmolded tab
- Reduced weight

BOD2			Ratings			
Symbol	Definitions	Conditions	min.	typ.	max.	
$I_D$	drain current	$V_D = 0.8 \cdot V_{BO}$			10 200	$\mu A$ $\mu A$
$V_{BO}$	breakover voltage	$V_{BO}(T_{VJ}) = V_{BO, 25^\circ C} [1 + K_T (T_{VJ} - 25^\circ C)]$				V
$I_{RMS}$	RMS current	f = 50 Hz pins soldered to printed circuit (conductor 0.035x2mm)			1.4	A
$I_{FAVM}$	maximum average forward current				0.9	A
$I_{SM}$	maximum pulsed source current	$t_p = 0.1$ ms; non repetitive			250	A
$I^2t$	$I^2t$ value for fusing	$t_p = 0.1$ ms			3.1	A <sup>2</sup> s
$K_T$	temperature coefficient of $V_{BO}$				0.7 · 10 <sup>-3</sup>	K <sup>-1</sup>
$K_P$	coefficient for energy per pulse EP (material constant)				700	K/Ws
$R_{thJA}$	thermal resistance junction to ambient	natural convection with air speed 2 m/s			60 45	K/W K/W
$I_{BO}$	breakover current				15 6	mA mA
$I_H$	holding current				20 12	mA mA
$V_H$	holding voltage		4		8	V
$(dv/dt)_{cr}$	critical rate of rise of voltage	$V_D = 0.9 \cdot V_{BO}$			3000 1000	V/ $\mu s$ V/ $\mu s$
$(di/dt)_{cr}$	critical rate of rise of current	$I_T = 100$ A; $V_D = V_{BO}$ ; f = 50 Hz $I_T = 600$ A; non repetitive			200 500	A/ $\mu s$ A/ $\mu s$
$t_q$	turn-off time	$V_D = 0.75 \cdot V_{BO}$ ; $V_R = 0$ V; $I_T = 100$ A $dv/dt_{(lin.)} = 5000$ V/ $\mu s$ ; $di/dt = -500$ A/ $\mu s$		200		$\mu s$
$V_T$	forward voltage drop	$I_T = 10$ A			1.3 1.2	V V
$V_{T0}$	threshold voltage	for power-loss calculation only			0.75	V
$r_T$	slope resistance				0.05	$\Omega$

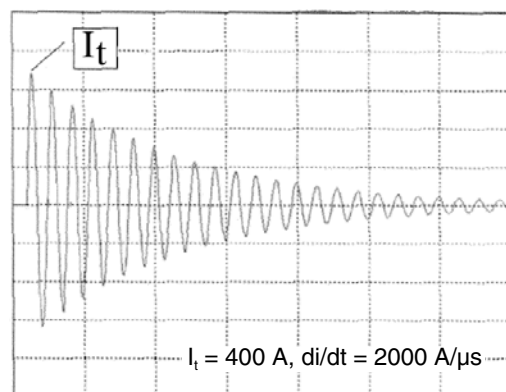
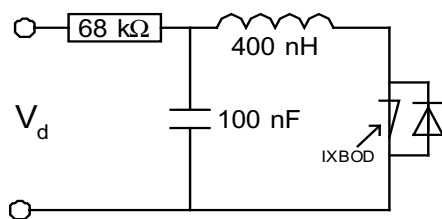

Package FP-Case			Ratings		
Symbol	Definitions	Conditions	min.	typ.	max.
$T_{amb}$	ambient temperature (cooling medium)		-40		150 °C
$T_{stg}$	storage temperature		-40		150 °C
$T_{vJM}$	maximum virtual junction temperature		-40		150 °C
<b>Weight</b>				0.9	g

### Product Marking

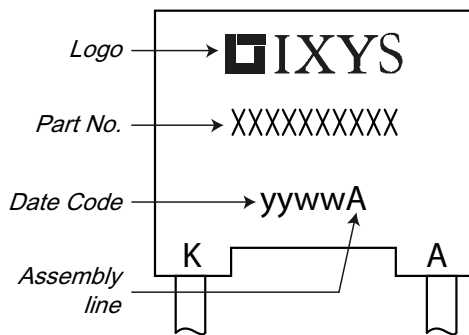

Ordering	Part Name	Marking on Product	Delivering Mode	Base Qty	Ordering Code
Standard	IXBOD2-04	IXBOD2-04	Box	100	511174
Standard	IXBOD2-05	IXBOD2-05	Box	100	tdb
Standard	IXBOD2-06	IXBOD2-06	Box	100	tdb
Standard	IXBOD2-07	IXBOD2-07	Box	100	508425
Standard	IXBOD2-08	IXBOD2-08	Box	100	507602
Standard	IXBOD2-09	IXBOD2-09	Box	100	511668
Standard	IXBOD2-10	IXBOD2-10	Box	100	508078
Standard	IXBOD2-11	IXBOD2-11	Box	100	511860
Standard	IXBOD2-12	IXBOD2-12	Box	100	511675
Standard	IXBOD2-13	IXBOD2-13	Box	100	511682
Standard	IXBOD2-14	IXBOD2-14	Box	100	509782

**Outlines FP-case**

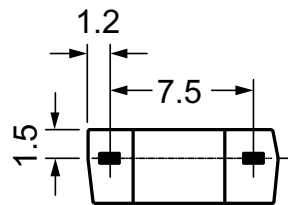
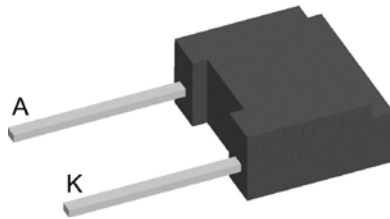

**Dimensions in mm**  
(1 mm = 0.0394")

