

XPT IGBT

tentative

$$V_{CES} = 1200V$$

$$I_{C25} = 43A$$

$$V_{CE(sat)} = 1.8V$$

ISOPLUS™ Surface Mount Power Device
 Boost Topology
 XPT IGBT

Part number

IXA30RG1200DHGLB



Backside: isolated

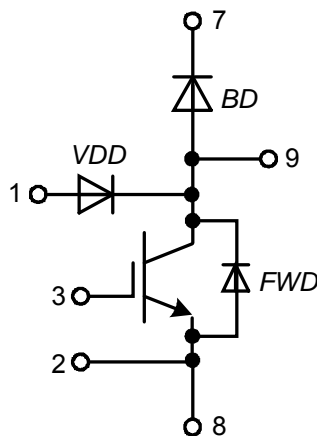
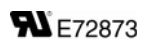

Features / Advantages:

- XPT IGBT
 - low saturation voltage
 - positive temperature coefficient for easy paralleling
 - fast switching
 - short tail current for optimized performance in resonant circuits
- Sonic™ diode
 - fast reverse recovery
 - low operating forward voltage
 - low leakage current
 - low temperature dependency of reverse recovery
- Vcesat detection diode (VDD)
 - integrated into package
 - very fast diode

Applications:

- AC drives
 - brake chopper
- PFC
 - boost chopper
- Switched reluctance drives

Package: SMPD

- Industry convenient outline
- RoHS compliant
- Epoxy meets UL 94V-0
- Soldering pins for PCB mounting
- Backside: DCB ceramic
- Reduced weight
- Advanced power cycling
- Isolation Voltage: 3000 V~

Free Wheeling Diode FWD				Ratings			
Symbol	Definition	Conditions	min.	typ.	max.	Unit	
V_{RSM}	max. non-repetitive reverse blocking voltage	$T_{VJ} = 25^{\circ}C$			1200	V	
V_{RRM}	max. repetitive reverse blocking voltage	$T_{VJ} = 25^{\circ}C$			1200	V	
I_R	reverse current, drain current	$V_R = 1200 V$	$T_{VJ} = 25^{\circ}C$		30	μA	
		$V_R = 1200 V$	$T_{VJ} = 125^{\circ}C$		0.5	mA	
V_F	forward voltage drop	$I_F = 30 A$	$T_{VJ} = 25^{\circ}C$		2.20	V	
						V	
		$T_{VJ} = 125^{\circ}C$	$I_F = 30 A$		2.20	V	
			$I_F = 60 A$			V	
I_{FAV}	average forward current	$T_C = 80^{\circ}C$ rectangular $d = 0.5$	$T_{VJ} = 150^{\circ}C$		25	A	
V_{FO}	threshold voltage	} for power loss calculation only	$T_{VJ} = 150^{\circ}C$		1.26	V	
r_F	slope resistance				28	m Ω	
R_{thJC}	thermal resistance junction to case				1	K/W	
R_{thCH}	thermal resistance case to heatsink			0.30		K/W	
P_{tot}	total power dissipation		$T_C = 25^{\circ}C$		125	W	
I_{FSM}	max. forward surge current	$t = 10 ms; (50 Hz), sine; V_R = 0 V$	$T_{VJ} = 45^{\circ}C$		200	A	
C_J	junction capacitance	$V_R = 400 V f = 1 MHz$	$T_{VJ} = 25^{\circ}C$		13	pF	

VCEsat Detection Diode VDD				Ratings			
Symbol	Definition	Conditions	min.	typ.	max.	Unit	
V_{RRM}	max. repetitive reverse blocking voltage	$T_{VJ} = 25^{\circ}C$			1200	V	
I_R	reverse current, drain current	$V_{R/D} = 1200 V$	$T_{VJ} = 25^{\circ}C$		2	μA	
		$V_{R/D} = 1200 V$	$T_{VJ} = 125^{\circ}C$		0.03	mA	
V_F	forward voltage drop	$I_F = 1 A$	$T_{VJ} = 25^{\circ}C$		2.20	V	
			$T_{VJ} = 125^{\circ}C$		1.80	V	
V_{FO}	threshold voltage	} for power loss calculation only	$T_{VJ} = 150^{\circ}C$		1.30	V	
r_F	slope resistance				390	m Ω	
C_J	junction capacitance	$V_R = 400 V; f = 1 MHz$	$T_{VJ} = 25^{\circ}C$		tbd	pF	
I_{RM}	max. reverse recovery current	} $V_R = 100 V; I_F = 1 A$ $-di/dt = 100 A/\mu s$	$T_{VJ} = 25^{\circ}C$		2.3	A	
t_{rr}	reverse recovery time		$T_{VJ} = 125^{\circ}C$		tbd	A	
			$T_{VJ} = 25^{\circ}C$		40	ns	
			$T_{VJ} = 125^{\circ}C$		tbd	ns	

Boost IGBT			Ratings			
Symbol	Definition	Conditions	min.	typ.	max.	Unit
V_{CES}	collector emitter voltage	$T_{VJ} = 25^{\circ}\text{C}$			1200	V
V_{GES}	max. DC gate voltage				± 20	V
V_{GEM}	max. transient collector gate voltage				± 30	V
I_{C25}	collector current	$T_C = 25^{\circ}\text{C}$			43	A
I_{C80}		$T_C = 80^{\circ}\text{C}$			30	A
P_{tot}	total power dissipation	$T_C = 25^{\circ}\text{C}$			147	W
$V_{CE(sat)}$	collector emitter saturation voltage	$I_C = 25\text{ A}; V_{GE} = 15\text{ V}$			1.8	V
					2.1	V
					2.1	V
$V_{GE(th)}$	gate emitter threshold voltage	$I_C = 1\text{ mA}; V_{CE} = V_{CE}$	5.4	5.9	6.5	V
I_{CES}	collector emitter leakage current	$V_{CE} = V_{CES}; V_{GE} = 0\text{ V}$			0.1	mA
					0.1	mA
I_{GES}	gate emitter leakage current	$V_{GE} = \pm 20\text{ V}$			500	nA
$Q_{G(on)}$	total gate charge	$V_{CE} = 600\text{ V}; V_{GE} = 15\text{ V}; I_C = 25\text{ A}$			76	nC
$t_{d(on)}$	turn-on delay time	inductive load $V_{CE} = 600\text{ V}; I_C = 25\text{ A}$ $V_{GE} = \pm 15\text{ V}; R_G = 39\ \Omega$				
t_r	current rise time					
$t_{d(off)}$	turn-off delay time					
t_f	current fall time					
E_{on}	turn-on energy per pulse					
E_{off}	turn-off energy per pulse					
R_{BSOA}	reverse bias safe operating area	$V_{GE} = \pm 15\text{ V}; R_G = 39\ \Omega$				
I_{CM}		$V_{CEmax} = 1200\text{ V}$			75	A
R_{SCSOA}	short circuit safe operating area	$V_{CEmax} = 1200\text{ V}$				
t_{sc}	short circuit duration	$V_{CE} = 900\text{ V}; V_{GE} = \pm 15\text{ V}$			10	μs
I_{sc}	short circuit current	$R_G = 39\ \Omega; \text{non-repetitive}$			100	A
R_{thJC}	thermal resistance junction to case				0.85	K/W
R_{thCH}	thermal resistance case to heatsink				0.25	K/W
Boost Diode BD						
V_{RRM}	max. repetitive reverse voltage	$T_{VJ} = 25^{\circ}\text{C}$			1200	V
I_{F25}	forward current	$T_C = 25^{\circ}\text{C}$			48	A
I_{F80}		$T_C = 80^{\circ}\text{C}$			32	A
V_F	forward voltage	$I_F = 30\text{ A}$			2.20	V
					1.90	V
I_R	reverse current	$V_R = V_{RRM}$			0.03	mA
					0.15	mA
Q_{rr}	reverse recovery charge	$V_R = 600\text{ V}$ $-di_F/dt = 600\text{ A}/\mu\text{s}$ $I_F = 30\text{ A}; V_{GE} = 0\text{ V}$				
I_{RM}	max. reverse recovery current					
t_{rr}	reverse recovery time					
E_{rec}	reverse recovery energy					
R_{thJC}	thermal resistance junction to case				1	K/W
R_{thCH}	thermal resistance case to heatsink				0.3	K/W

tentative

Package SMPD		Ratings				
Symbol	Definition	Conditions	min.	typ.	max.	Unit
I_{RMS}	RMS current	per terminal			100	A
T_{stg}	storage temperature		-55		150	°C
T_{vj}	virtual junction temperature		-55		150	°C
Weight				8.5		g
F_C	mounting force with clip		40		130	N
V_{ISOL}	isolation voltage	t = 1 second	3000			V
		t = 1 minute	2500			V
$d_{Spp/App}$	creepage distance on surface striking distance through air	terminal to terminal	1.6			mm
		terminal to backside	4.0			mm



Part number

I = IGBT
 X = XPT IGBT
 A = Gen 1 / std
 30 = Current Rating [A]
 RG = boost configuration
 1200 = Reverse Voltage [V]
 D = IGBT
 H = XPT IGBT
 G = Gen 1 / std
 LB = SMPD-B

Ordering	Part Number	Marking on Product	Delivery Mode	Quantity	Code No.
Standard	IXA30RG1200DHGLB	IXA30RG1200DHGLB	Blister	45	512356
Alternative	IXA30RG1200DHGLB-TRR	IXA30RG1200DHGLB	Tape & Reel	200	511654

Similar Part	Package	Voltage class
IXA20RG1200DHGLB	SMPD-B	1200
IXA40RG1200DHGLB	SMPD-B	1200

Outlines SMPD

A (8 : 1)



Boost IGBT

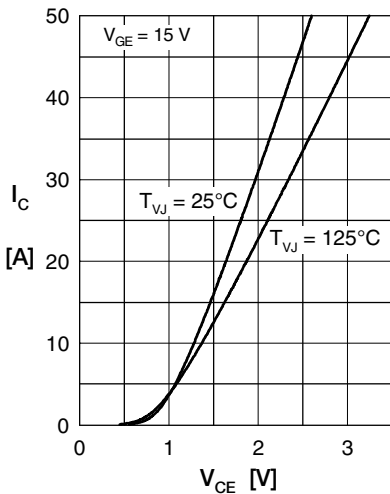

Fig. 1 Typ. output characteristics

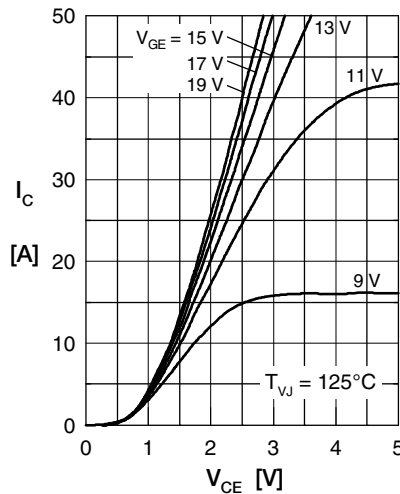

Fig. 2 Typ. output characteristics

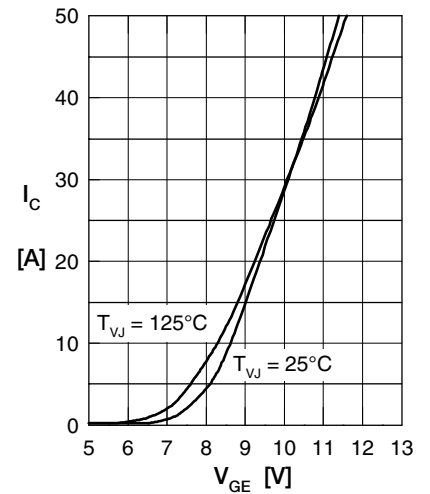

Fig. 3 Typ. transfer characteristics

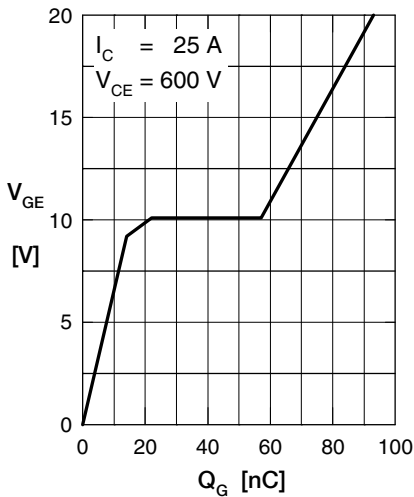

Fig. 4 Typ. turn-on gate charge

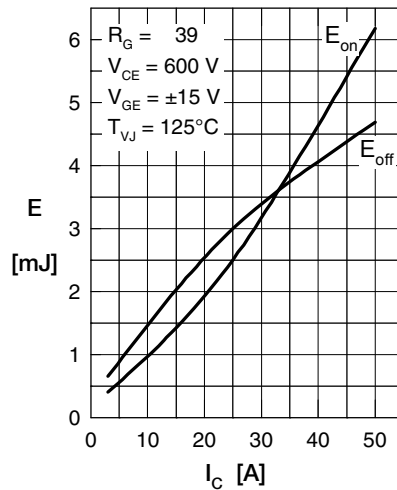

Fig. 5 Typ. switching energy versus collector current

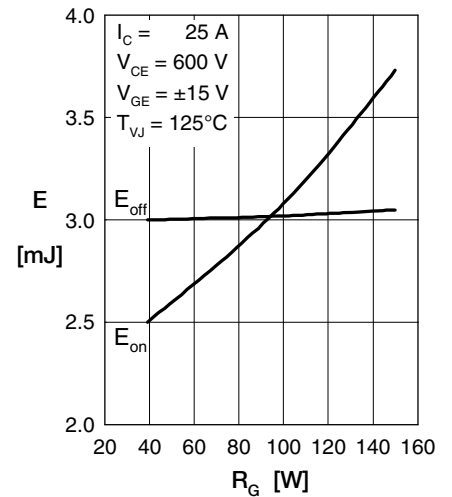

Fig. 6 Typ. switching energy versus gate resistance

Fig. 7 Typ. transient thermal impedance junction to case

Boost Diode BD

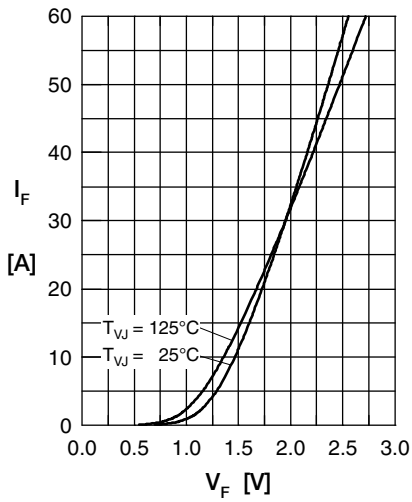

Fig. 1 Typ. Forward current versus V_F

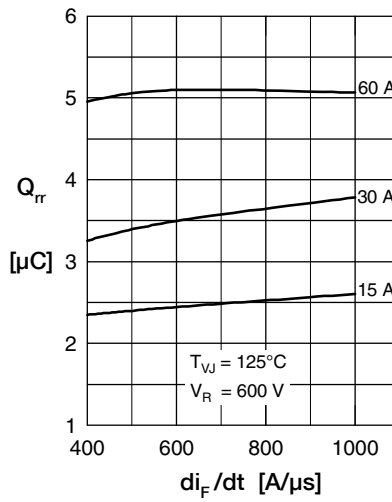

Fig. 2 Typ. reverse recov.charge Q_{rr} versus di/dt

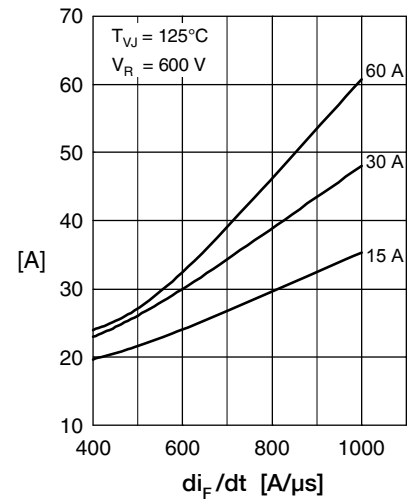

Fig. 3 Typ. peak reverse current I_{RM} versus di/dt

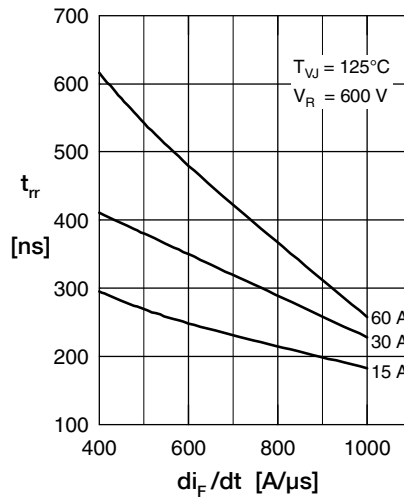

Fig. 4 Dynamic parameters Q_{rr} , I_{RM} versus di/dt

Fig. 5 Typ. recovery time t_{rr} versus di/dt

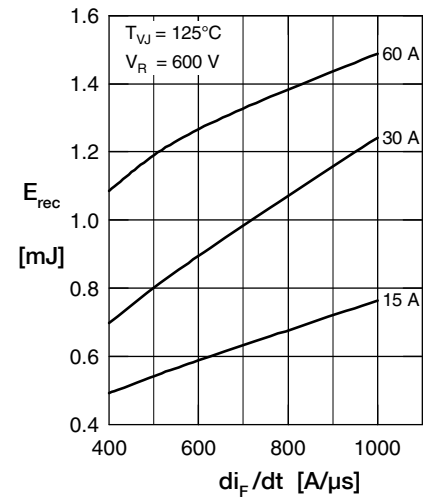

Fig. 6 Typ. recovery energy E_{rec} versus di/dt

Fig. 7 Typ. transient thermal impedance junction to case