



Product Change Notification



Product Group: Opto Modules & Visibles 23-APR-2021 / PCN OMV-1179-2021 Rev. 0

TITLE: Redesign of IL300 Linear optocoupler product series

DESCRIPTION OF CHANGE: Vishay introduces a new design for the IL300 series. This design will use a new type of construction and new dies. As a result there is a slight difference in the dimensions of the package. The new package will be white in color and still conforms to the industry standards. There is no change in the manufacturing location. There are some electrical specification changes as well. The major ones are as follows:

K1, K2 gain min and max
IP1, IP2 typ. values
VF typ. value
Reduced K3 bin categories
Rise and Fall time typ. values

For a detailed comparison of the new and current design, please refer to document "Details of changes _ PCN OMV-1179-2021.pdf"

CLASSIFICATION OF CHANGE: Bill of Material (Major) / Assembly Process/Structure / Direct Materials (Major)
REASON FOR CHANGE: To transfer to a new production line according to state of the art technology with increased production capacity and to change to a more robust new construction.

EXPECTED INFLUENCE ON QUALITY RELIABILITY / PERFORMANCE: These products have undergone a comprehensive qualification and characterization program. There is no adverse effects on the quality and performance of the product.

PRODUCT CATEGORY: Optocouplers, Isolators

PART NUMBERS / SERIES / FAMILIES AFFECTED:

This PCN impacts the IL300 product series. The products are:

IL300, IL300-X007, IL300-X007T, IL300-X009T, IL300-X016, IL300-X017
IL300-3124
IL300-DEFG, IL300-DEFG-X001, IL300-DEFG-X006, IL300-DEFG-X007, IL300-DEFG-X007T, IL300-DEFG-X009T,
IL300-DEFG-X016, IL300-DEFG-X017, IL300-DEFG-X017T
IL300-DEF-X009T
IL300-E, IL300-E-X006, IL300-E-X007T, IL300-E-X009T
IL300-EF, IL300-EF-X007, IL300-EF-X007T, IL300-EF-X009T, IL300-EF-X016, IL300-EF-X017, IL300-EF-X017T
IL300-F, IL300-F-X001, IL300-F-X007, IL300-F-X007T, IL300-F-X009, IL300-F-X009T, IL300-F-X016, IL300-F-X017T

VISHAY BRAND(s): VISHAY SEMICONDUCTORS

TIME SCHEDULE:

Start Shipment Date: 05-JUL-2021

SAMPLES AVAILABLE BEGINNING: 19-APR-2021

We need samples for evaluation: Yes No
If Yes return this form to contact information below.

Annotations about time schedule:

Components with the change implemented could start shipping on or after the Start Shipment Date. The exact date will be a function of the depletion of the existing product inventories. Final orders can only be accepted on or before the last order date and are subject to the availability. Early ordering is strongly recommended!

PRODUCT IDENTIFICATION: This change can be tracked by package colour

QUALIFICATION DATA: This change has been rigorously qualified by company and industry standard qualifications. The qualification data is available upon request

This PCN is considered approved, without further notification, unless we receive specific customer concerns before: 30-JUN-2021 or as specified by contract.

ISSUED BY:

PM: Nadide Deniz Goerk,

Phone: +49 7131 7498 600

Email: Nadidedeniz.Goerk@vishay.com

For further Information, please contact your regional Vishay office.**CONTACT INFORMATION:**

VISHAY Intertechnology Asia Pte. Ltd.
Business Marketing Asia/Japan
25 Tampines Street 92
Keppel Building # 02-00
Singapore 528877
Phone: +65 6780 7879
Fax: +65 6780 7897

VISHAY Intertechnologies, Inc.
Business Marketing The Americas - Opto
2585 Junction Avenue
San Jose, California 95134-1923
United States of America
Phone: +1-408-567-8358
Fax: +1 408-240-5687

VISHAY Semiconductor GmbH
Business Marketing Europe Opto
Theresienstr. 2
D-74025 Heilbronn
Germany
Phone: +49-7131-67-2113
Fax: +49-7131-67-3144



Product Change Notification



Product Group: Opto Modules & Visibles 23-APR-2021 / PCN OMV-1179-2021 Rev. 0

Attached Part Number List:

Material IL300 IL300-3124 IL300-DEFG IL300-DEFG-X001 IL300-DEFG-X006 IL300-DEFG-X007 IL300-DEFG-X007T IL300-DEFG-X009T IL300-DEFG-X016 IL300-DEFG-X017 IL300-DEFG-X017T IL300-DEF-X009T IL300-E IL300-EF IL300-EF-X007 IL300-EF-X007T IL300-EF-X009T IL300-EF-X016 IL300-EF-X017 IL300-EF-X017T IL300-E-X006 IL300-E-X007T IL300-E-X009T IL300-F IL300-F-X001 IL300-F-X007 IL300-F-X007T IL300-F-X009 IL300-F-X009T IL300-F-X016 IL300-F-X017T IL300-X007 IL300-X007T IL300-X009T IL300-X016 IL300-X017

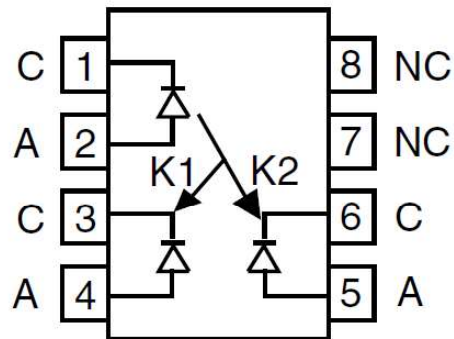

Details of Changes to IL300 Series Addressed in PCN OMV-1179-2021

1 1. Contents

PCN OMV-1179-2021

Section	Page
1 1. CONTENTS	2
2 INTRODUCTION	3
2.1 GENERAL PCN INFORMATION	3
3 CHANGES ASSOCIATED WITH THIS PCN.....	2
3.1 EMITTER CHIP CHANGE.....	2
3.2 DETECTOR CHIP CHANGE.....	2
3.3 PACKAGE.....	2
3.4 MARKING.....	4
3.5 PRODUCTION LINE.....	4
3.6 MISCELLANEOUS.....	4
3.7 SPECIFICATION CHANGES.....	4
3.7.1 <i>Changes to Data Sheet limits</i>	4
3.7.2 <i>Corrections to the current datasheet</i>	5
3.8 CHARACTERISTICS.....	5

CONFIDENTIAL

THIS DOCUMENT IS SUBJECT TO CHANGE WITHOUT NOTICE. THE PRODUCTS DESCRIBED HEREIN AND THIS DOCUMENT ARE SUBJECT TO SPECIFIC DISCLAIMERS, SET FORTH AT www.vishay.com/doc?91000

2 Introduction

This document presents additional information with respect to the changes addressed in PCN OMV-1179-2021 concerning the IL300, linear optocoupler, series products.

2.1 General PCN information

The PCN presents changes to the IL300 series (see detailed list below). This product uses Vishay's new more robust Double Mold Planar Process (DMP). The linear coupler consists of 3 dies, one IrLED and two PIN diodes. The AlGaAs IrLED is optically coupled to both the feedback PIN diode and the output PIN diode in a bifurcated arrangement. These components are encapsulated in a DIP8 plastic package. The final assembly and test occur in Vishay's facility in Krubong, Malaysia.

The changes consist of a redesigning of the product and the transfer of the product to a new production line of cutting edge technology with increased production capacity. The new component also utilizes environmentally friendly material.

The complete list of products impacted by the PCN is listed below:

Material
IL300
IL300-3124
IL300-DEFG
IL300-DEFG-X001
IL300-DEFG-X006
IL300-DEFG-X007
IL300-DEFG-X007T
IL300-DEFG-X009T
IL300-DEFG-X016
IL300-DEFG-X017
IL300-DEFG-X017T
IL300-DEF-X009T

Material
IL300-E
IL300-EF
IL300-EF-X007
IL300-EF-X007T
IL300-EF-X009T
IL300-EF-X016
IL300-EF-X017
IL300-EF-X017T
IL300-E-X006
IL300-E-X007T
IL300-E-X009T
IL300-F

Material
IL300-F-X001
IL300-F-X007
IL300-F-X007T
IL300-F-X009
IL300-F-X009T
IL300-F-X016
IL300-F-X017T
IL300-X007
IL300-X007T
IL300-X009T
IL300-X016
IL300-X017

The new parts were realized by pairing up a new emitter with an improved version of the current detector (PIN diode) to meet the same performance requirements with minimum change to datasheet specifications. The new emitter uses MOVPE manufacturing technology allowing more consistent performance across all products, while the detector is a derivative of the existing product.

Both current and new version of these chips are sourced out of Vishay's fabrication lines in Heilbronn Germany. The DMP construction and process represents a new manufacturing line from our existing factory in Krubong, Malaysia.

3 Changes associated with this PCN.

3.1 Emitter chip change.



The emitter was revised to the MOVPE multi-quantum well GaAlAs technology to provide a greater light output to achieve product specifications comparable with the current product.

3.2 Detector chip change

The detector is a derivative of the current chip (the difference between the two is not detectable by physical appearance)

3.3 Package

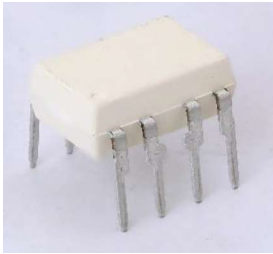
The package has been redesigned resulting in several changes. The most notable of these changes is the colour of the outer molding compound. Less noticeable is the change in construction and the change in package dimensions.

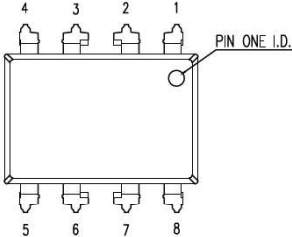
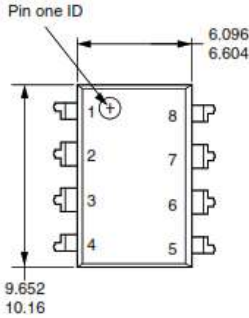
NEW	CURRENT
Color of Package	
	
Package Dimension: The package still conforms to the JEDEC standard, some of the dimensions have slight changes.	
	

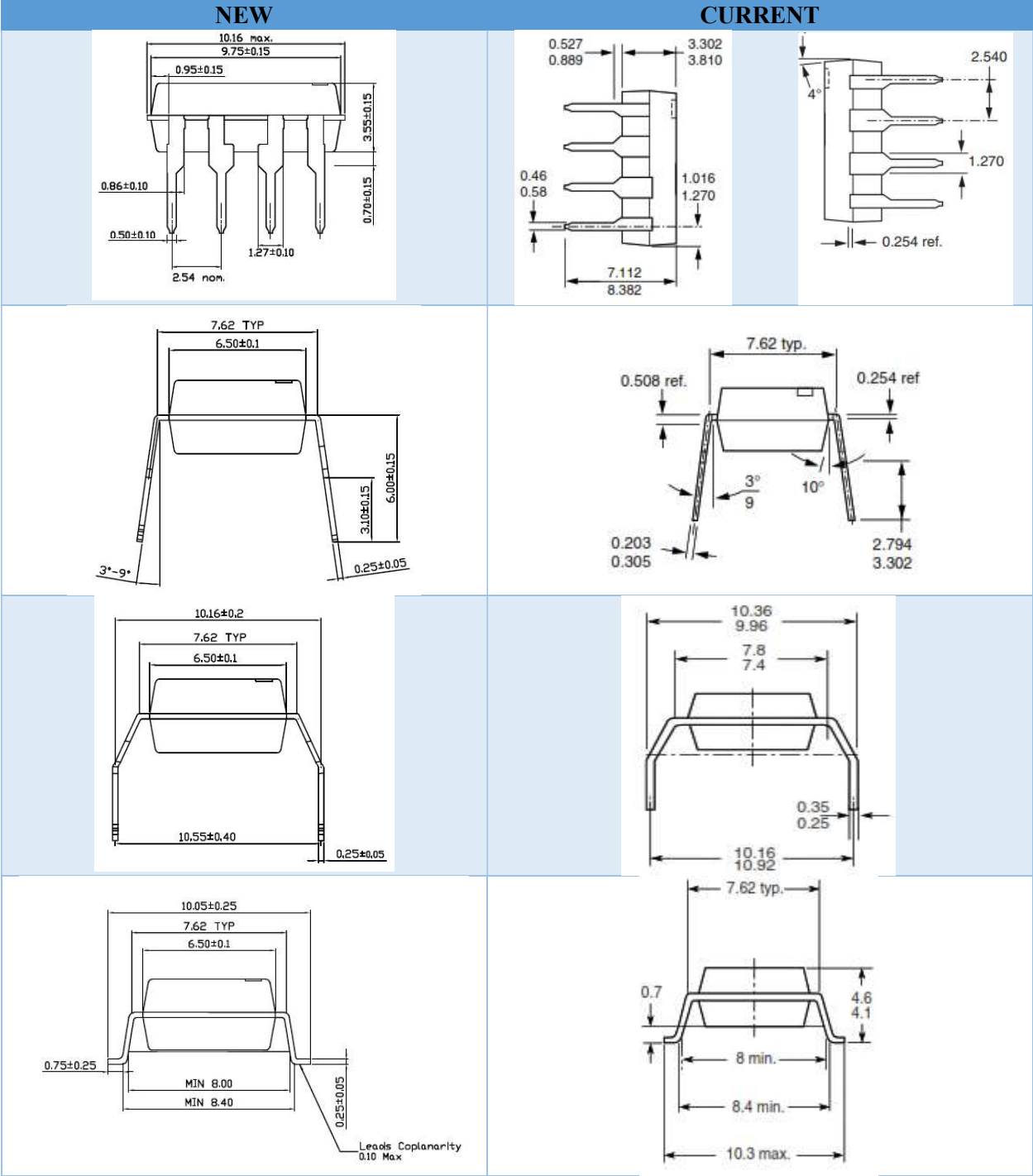

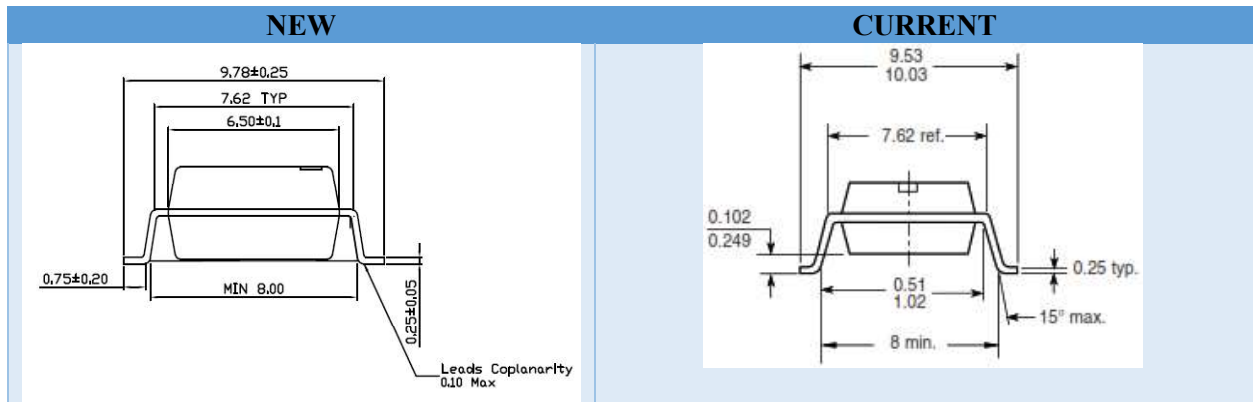

3.4 Marking

There is no change in product marking

3.5 Production Line

The product has been transferred to a state of the art production line with increased production capacity.

3.6 Miscellaneous

1. Existing Product names will not change.
2. The new parts all retain the same safety agency certification as the current version.
3. There are no changes in the production testing of the product.
4. New Links to resources have been added to the data sheet.

3.7 Specification Changes

Due to the change of the die some of the characteristics will change. These changes are reflected in the typical values in the data sheet as demonstrated in the table below.

	New	Current	units
Forward Voltage (V_F) @ $10mA I_F$	1.4	1.25	V
Short circuit Current (I_{SC}) @ $10mA I_F$	90	120	μA
Output Current (I_{p1}, I_{p2}) @ $10mA I_F, V_{det} = -15 V$	90	120	μA
K1, K2 Output Current Gain @ $10mA I_F, V_{det} = -15 V$	0.009	0.012	
Rise time @ $I_F=10mA$	0.8	1.75	μs
Fall time @ $I_F=10mA$	0.8	1.75	μs

The parameter changes are small and fall within the existing data sheet specification.

3.7.1 Changes to Data Sheet limits.

The following shows a comparison of the parametric limits that were changed in the data sheet as a result of this new design.

			New			Current			
ABSOLUTE MAXIMUM RATINGS									
PARAMETER	TEST CONDITION	SYMBOL	VALUE			VALUE			UNIT
Input Power distribution		P _{diss}	100			160			mW
Derate linearly from 25 °C			-			2.13			mW/°C
Input Thermal resistance		R _{th}	-			470			°K/W
Input Junction temperature		T _j	125			100			°C
Output Power: Derate linearly from 25 °C			-			0.65			mW/°C
Input Thermal resistance		R _{th}	-			1500			°K/W
Input Junction temperature		T _j	125			100			°C
Total Package Power distribution at 25°C		P _{diss}	150			210			mW
Derate linearly from 25 °C			-			2.8			mW/°C
ELECTRICAL CHARACTERISTICS									
PARAMETER	TEST CONDITION	SYMBOL	MIN	TYP.	MAX	MIN	TYP.	MAX	UNIT
Forward Voltage	I _F = 10 mA	V _F		1.4			1.25		V
V _F temperature coefficient		ΔV _F /Δ°C		-			-2.2		mW/°C
Input Junction capacitance	V _F = 0 V, f = 1 MHz	C _j		26			15		pF
Input Dynamic resistance	I _F = 10 mA	ΔV _F /ΔI _F		-			6		Ω
Output short circuit current	I _F = 10 mA	I _{SC}		90			120		μA
Output noise equivalent power	V _{det} = 15V	NEP		-			4 x 10 ⁻¹⁴		Ω/√Hz
K1, servo gain (I _{P1} /I _F)	I _F = 10 mA, V _{det} = -15 V	K1	0.005	0.009	0.015	0.006	0.012	0.017	
Servo photocurrent	I _F = 10 mA, V _{det} = -15 V	I _{P1}		90			120		μA
K2, servo gain (I _{P2} /I _F)	I _F = 10 mA, V _{det} = -15 V	K2	0.005	0.009	0.015	0.006	0.012	0.017	
Forward photocurrent	I _F = 10 mA, V _{det} = -15 V	I _{P2}		90			120		μA

3.7.2 Corrections to the current datasheet

The test condition for Transfer Gain Stability has been corrected with T_{amb} = 0 °C to 75 °C.
The test condition for Transfer Gain Linearity has been corrected with I_F = 2.0 to 10 mA

3.8 Characteristics

Detailed product characterization has been performed on this series of products. Some slight changes in electrical parameters and performance were observed.

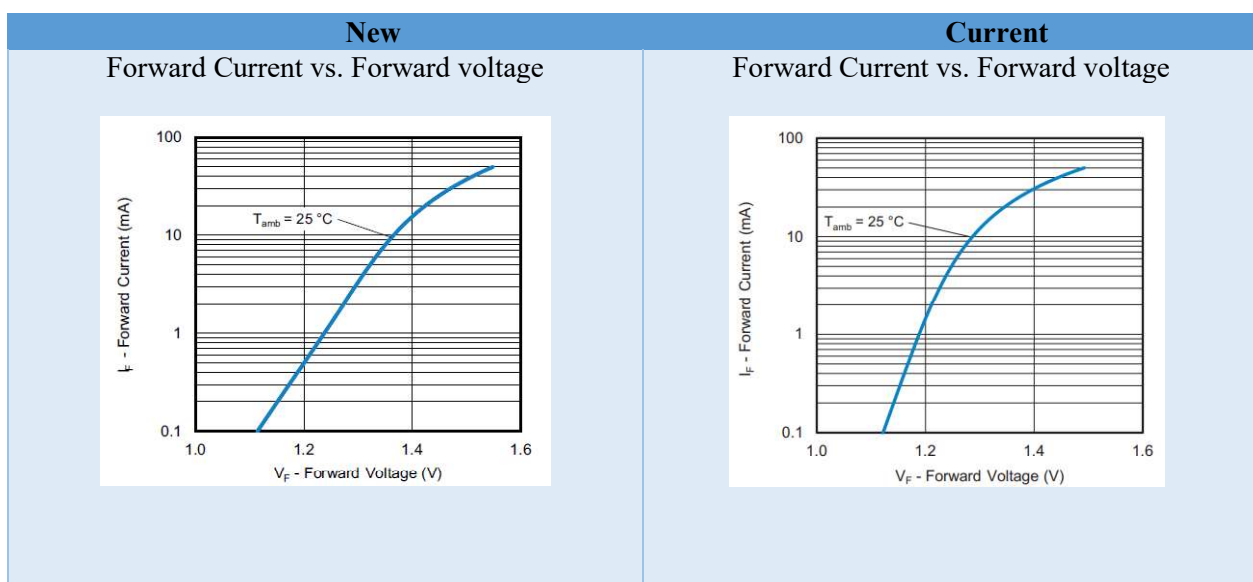

CONFIDENTIAL

THIS DOCUMENT IS SUBJECT TO CHANGE WITHOUT NOTICE. THE PRODUCTS DESCRIBED HEREIN AND THIS DOCUMENT ARE SUBJECT TO SPECIFIC DISCLAIMERS, SET FORTH AT www.vishay.com/doc?91000

Servo Photocurrent vs. Forward Current

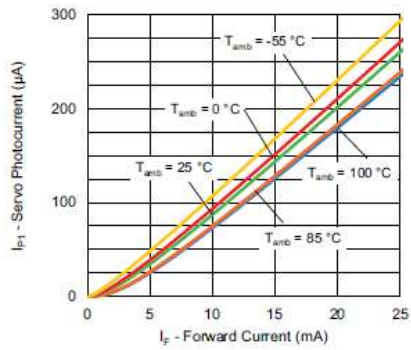

Servo Photocurrent vs. Forward Current

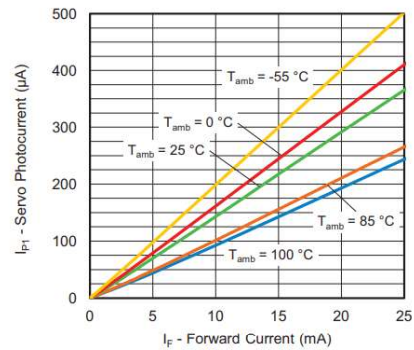

Normalized Photodiode Current vs. Forward Current

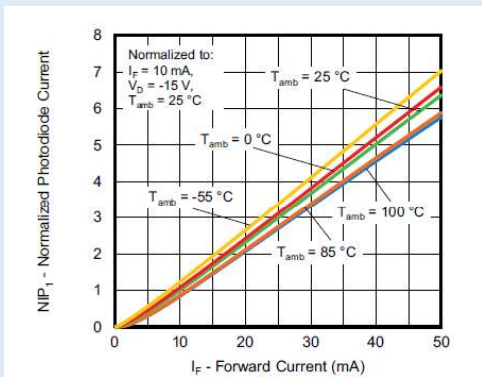

Normalized Photodiode Current vs. Forward Current

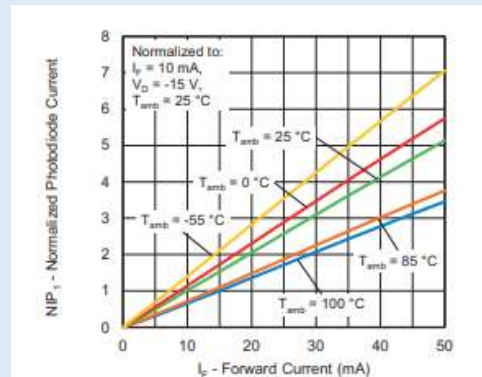

Servo Gain vs. Forward Current

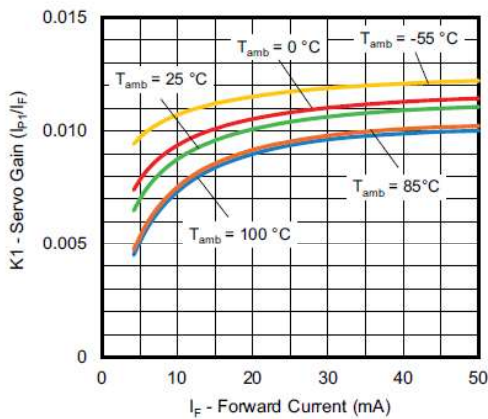

Servo Gain vs. Forward Current

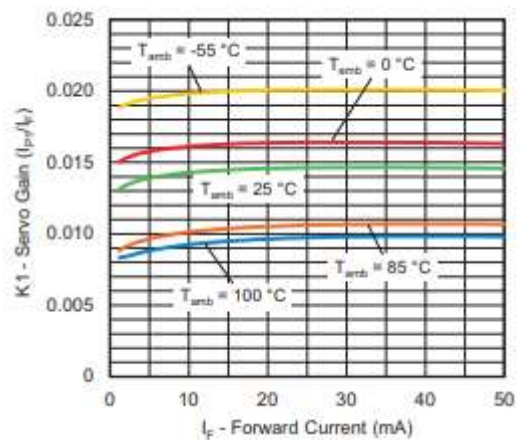

Normalized Transfer Gain vs. Forward Current

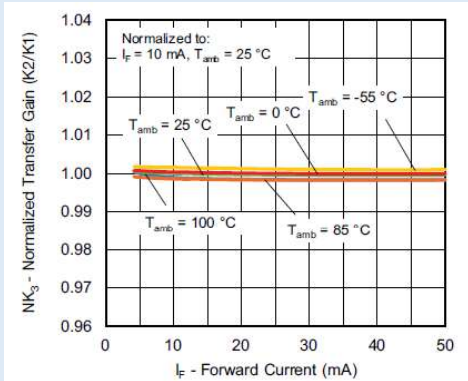

Normalized Transfer Gain vs. Forward Current

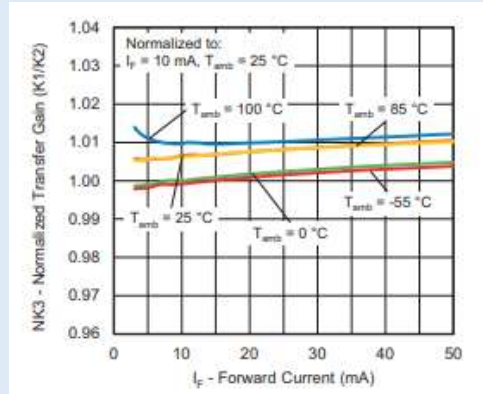

Voltage Gain vs. Frequency (2 mA)

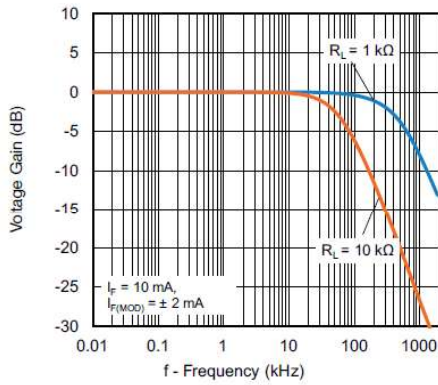

Voltage Gain vs. Frequency (2 mA)

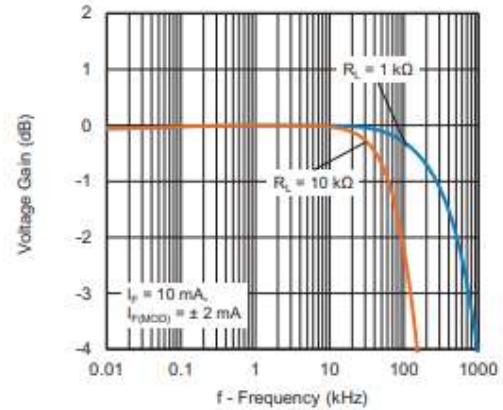

Voltage Gain vs. Frequency

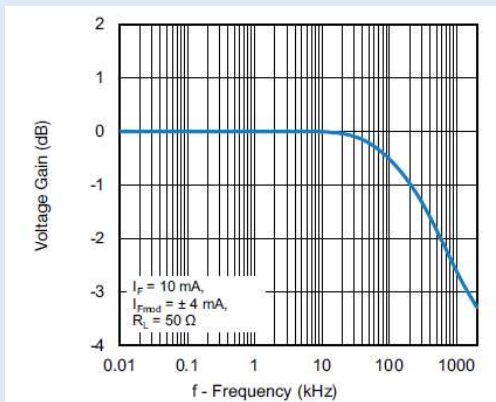

Voltage Gain vs. Frequency

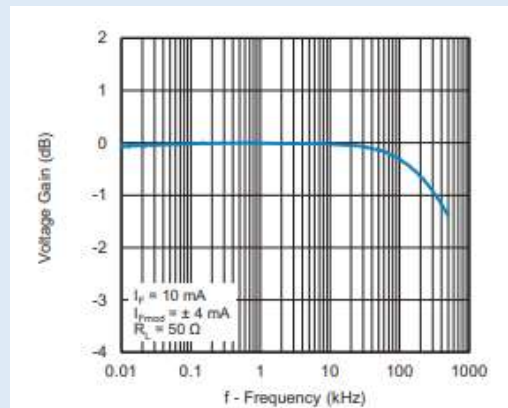

Phase Angle vs. Frequency

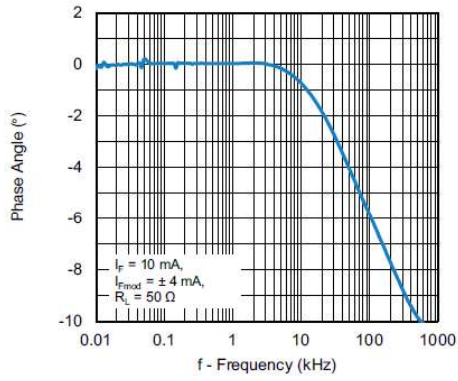

Phase Angle vs. Frequency

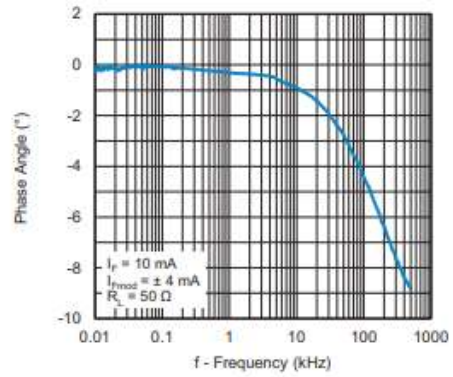

Common-Mode Rejection Ratio vs. Frequency

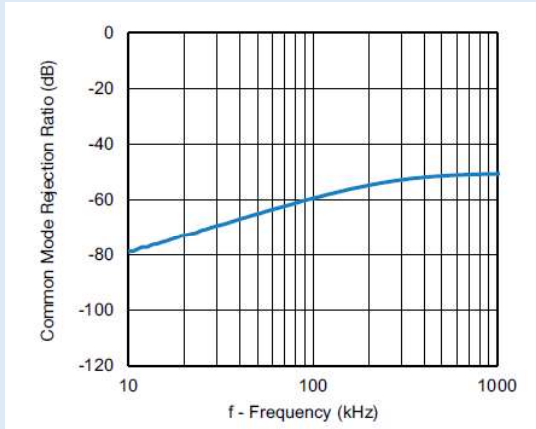

Common-Mode Rejection Ratio vs. Frequency

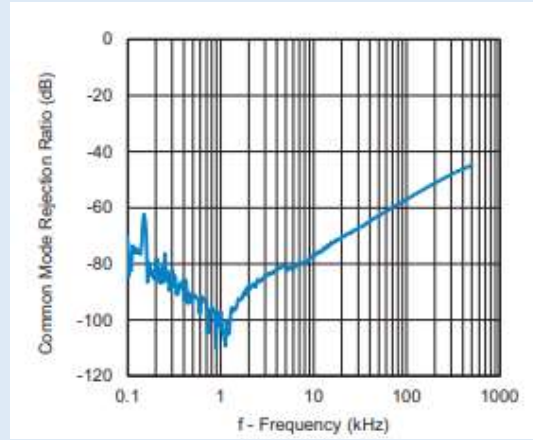

CONFIDENTIAL

THIS DOCUMENT IS SUBJECT TO CHANGE WITHOUT NOTICE. THE PRODUCTS DESCRIBED HEREIN AND THIS DOCUMENT ARE SUBJECT TO SPECIFIC DISCLAIMERS, SET FORTH AT www.vishay.com/doc?91000