

■ Features

- Constant Current mode output
- Flicker free design
- PCB type design
- Built-in active PFC function
- No load power consumption<0.5W(Blank-Type), Standby power consumption<0.5W(DA-Type)
- Function options: 2 in 1 dimming (dim-to-off); Auxiliary DC output; DALI
- 3 years warranty

■ Applications

- LED panel lighting
- LED flood lighting
- Indoor LED lighting

■ Description

IDPC-65 series is a 65W PCB type LED AC/DC driver featuring the constant current mode output with flicker free design. IDPC-65 operates from 180~295VAC and offers models with different rated current ranging between 700mA and 1750mA. Thanks to the efficiency up to 89%, with the fanless design, the entire series is able to operate for -20°C~+40°C ambient temperature under free air convection. IDPC-65 is equipped with various function options, such as dimming methodologies, so as to provide the optimal design flexibility for lighting system.

■ Model Encoding

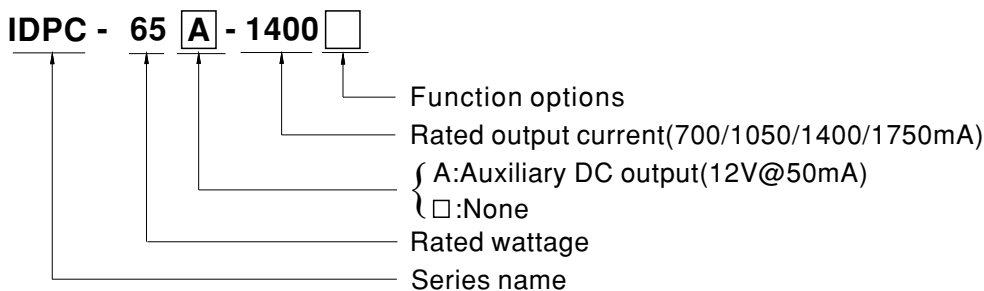

Type	Function	Note
Blank	2 in 1 dimming (0~10VDC and 10V PWM)	In Stock
DA	DALI control technology	In Stock

Note: The DALI control model(DA Type) only for IDPC-65 Non Auxiliary DC output models.



SPECIFICATION

MODEL		IDPC-65□-700□	IDPC-65□-1050□	IDPC-65□-1400□	IDPC-65□-1750□
OUTPUT	RATED CURRENT	700mA	1050mA	1400mA	1750mA
	RATED POWER	65.1W	65.1W	64.4W	63W
	CONSTANT CURRENT REGION <small>Note.2</small>	69 ~ 93V	46 ~ 62V	34 ~ 46V	27 ~ 36V
	OPEN CIRCUIT VOLTAGE _(max.)	118V	82V	60V	53V
	CURRENT RIPPLE	5% max. @rated current			
	CURRENT TOLERANCE	±7.0%			
	SETUP TIME <small>Note.4</small>	500ms / 230VAC			
	AUXILIARY DC OUTPUT <small>Note.5</small>	Nominal 12V(deviation 11.4~12.6)@50mA for IDPC-65A only			
INPUT	VOLTAGE RANGE <small>Note.3</small>	180 ~ 295VAC 254 ~ 417VDC (Please refer to "STATIC CHARACTERISTIC" section)			
	FREQUENCY RANGE	47 ~ 63Hz			
	POWER FACTOR (Typ.)	PF>0.95/230VAC, PF>0.9/277VAC@full load (Please refer to "POWER FACTOR (PF) CHARACTERISTIC" section)			
	TOTAL HARMONIC DISTORTION	THD<20%@load≥75%/230VAC, 277VAC (Please refer to "TOTAL HARMONIC DISTORTION" section)			
	EFFICIENCY (Typ.)	89%	87%	86%	86%
	AC CURRENT	0.4A/230VAC 0.3A/277VAC			
	INRUSH CURRENT (Typ.)	COLD START 30A(twidth=100μs measured at 50% Ipeak) at 230VAC; Per NEMA 410			
	MAX. No. of PSUs on 16A CIRCUIT BREAKER	32 units (circuit breaker of type B) / 32 units (circuit breaker of type C) at 230VAC			
	LEAKAGE CURRENT	<0.75mA / 277VAC			
	NO LOAD / STANDBY POWER CONSUMPTION	No load power consumption <0.5W for Blank-Type, <1.2W for IDPC-65A Standby power consumption <0.5W for DA-Type			
PROTECTION	SHORT CIRCUIT	Hiccup mode, auto-recovery after fault condition is removed for DA type; Hiccup mode, re-power on to recovery for other type			
ENVIRONMENT	WORKING TEMP.	Ta= -20 ~ +40°C (ambient temperature)			
	WORKING HUMIDITY	20 ~ 90% RH non-condensing			
	STORAGE TEMP., HUMIDITY	-40 ~ +80°C, 10 ~ 95% RH			
	TEMP. COEFFICIENT	±0.03%/°C (0 ~ 40°C)			
	VIBRATION	10 ~ 500Hz, 2G 10min./1cycle, period for 60min. each along X, Y, Z axes			
SAFETY & EMC	SAFETY STANDARDS	UL8750, CSA C22.2 NO.250.13-12; ENEC EN61347-1, EN61347-2-13, EN62384, GB19510.1, GB19510.14, EAC TP TC 004 approved			
	DALI STANDARDS <small>Note.7</small>	Compliance to IEC62386-101,102 for DA-Type only			
	WITHSTAND VOLTAGE	I/P-O/P:3.75KVAC			
	ISOLATION RESISTANCE	I/P-O/P:100M Ohms / 500VDC / 25°C/ 70% RH			
	EMC EMISSION	Compliance to EN55015, EN61000-3-2 Class C (≥75% load) ; EN61000-3-3, GB17743, GB17625.1, EAC TP TC 020			
	EMC IMMUNITY	Compliance to EN61000-4-2,3,4,5,6,8,11; EN61547, light industry level(surge immunity:Line-Line:1KV), EAC TP TC 020			
OTHERS	MTBF	380.7Khrs min. MIL-HDBK-217F (25°C)			
	DIMENSION	130*67.5*20.5mm(L*W*H)			
	PACKING	0.15Kg; 81pcs/ 13Kg/ 1.46CUFT			
NOTE	<ol style="list-style-type: none"> All parameters NOT specially mentioned are measured at 230VAC input, rated current and 25°C of ambient temperature. Please refer to "DRIVING METHODS OF LED MODULE". De-rating may be needed under low input voltages. Please refer to "STATIC CHARACTERISTIC" sections for details. Length of set up time is measured at cold first start. Turning ON/OFF the driver may lead to increase of the set up time or set up failure. Aux. 12V will be damaged with short circuit; It will not be available when output voltage is not in constant current region or output no load condition. The driver is considered as a component that will be operated in combination with final equipment. Since EMC performance will be affected by the complete installation, the final equipment manufacturers must re-qualify EMC Directive on the complete installation again. The DALI version driver does not support the bit 1: Lamp failure in the Command 144 Query status of the DALI standard. 				

■ **BLOCK DIAGRAM**

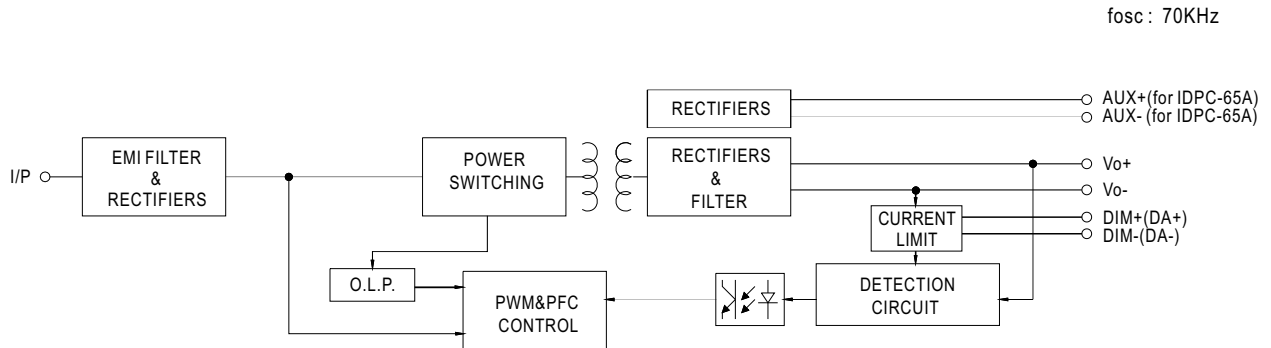

■ **DRIVING METHODS OF LED MODULE**

※ This series works in constant current mode to directly drive the LEDs.

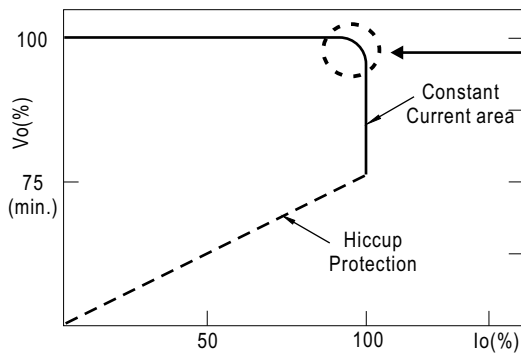

Typical output current normalized by rated current (%)

In the constant current region, the highest voltage at the output of the driver depends on the configuration of the end systems.
Should there be any compatibility issues, please contact MEAN WELL.

■ DIMMING OPERATION

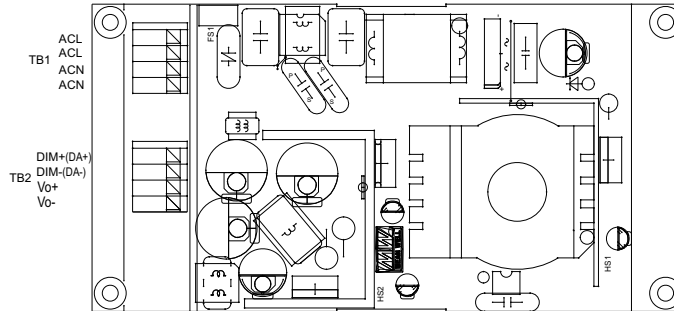

※ **2 in 1 dimming function**

- Output constant current level can be adjusted by applying one of the two methodologies between DIM+ and DIM-: 0 ~ 10VDC, or 10V PWM signal.
- Direct connecting to LEDs is suggested. It is not suitable to be used with additional drivers.

◎ Applying additive 0 ~ 10VDC

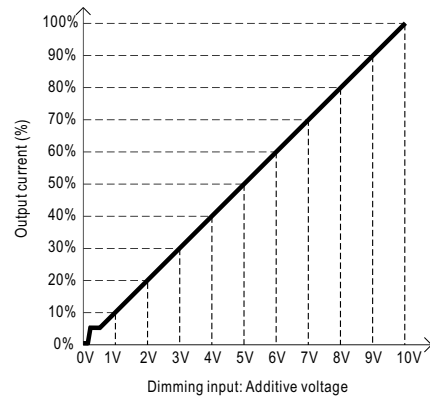
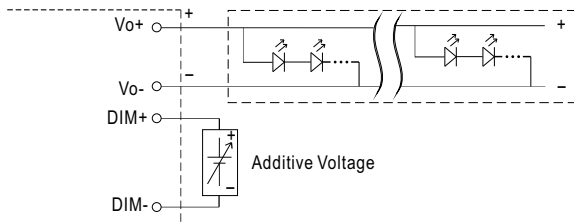

◎ Applying additive 10V PWM signal (frequency range 300Hz ~ 3KHz):

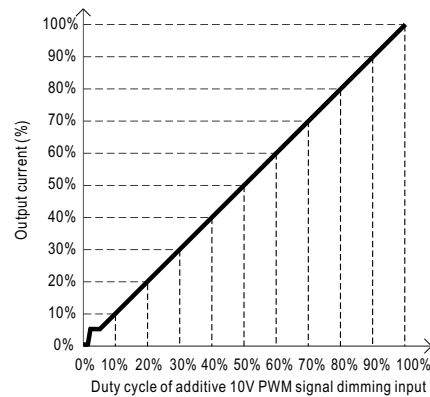
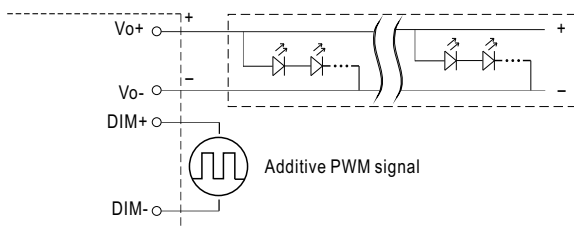

Note : 1. Min. dimming level is about 8% and the output current is not defined when $0% < I_{out} < 8%$.
 2. The output current could drop down to 0% when dimming input is about 0Vdc or 10V PWM signal with 0% duty cycle.

※ **DALI Interface (primary side; for DA-Type)**

- Apply DALI signal between DA+ and DA-.
- DALI protocol comprises 16 groups and 64 addresses.
- First step is fixed at 8% of output.

■ **OUTPUT LOAD vs TEMPERATURE**

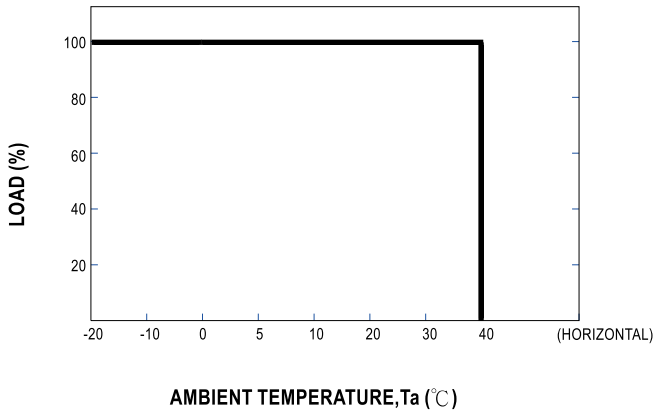

■ **STATIC CHARACTERISTIC**

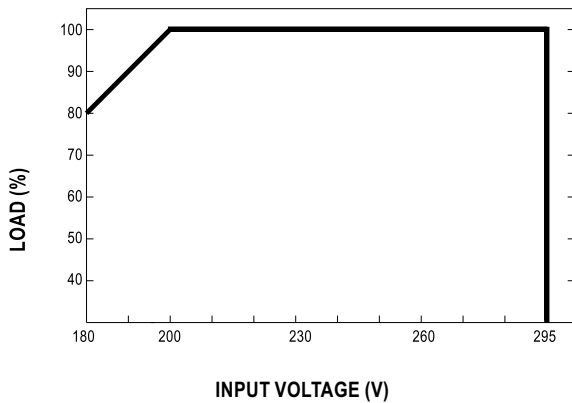

※ De-rating is needed under low input voltage.

■ **POWER FACTOR (PF) CHARACTERISTIC**

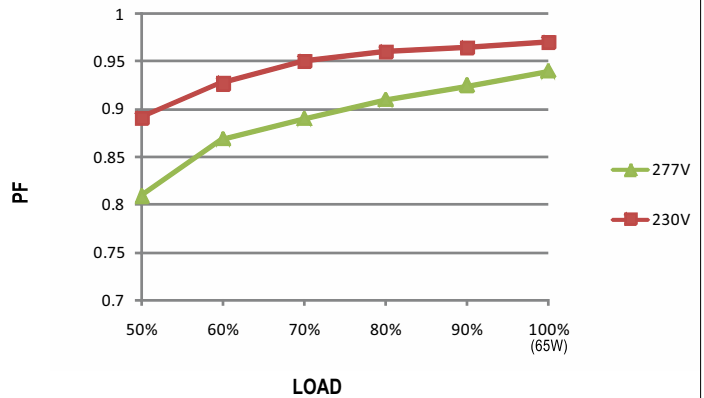

■ **TOTAL HARMONIC DISTORTION (THD)**

※ 700mA Model

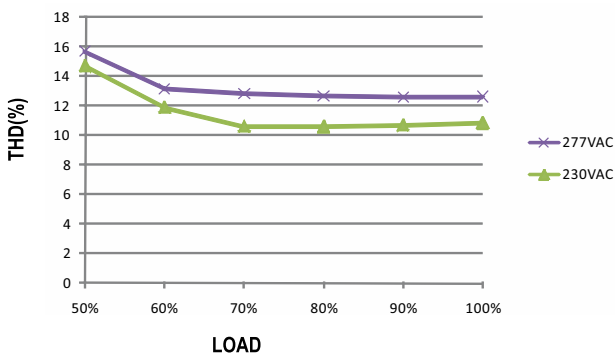

■ **EFFICIENCY vs LOAD**

IDPC-65 series possess superior working efficiency that up to 89% can be reached in field applications.

※ 700mA Model

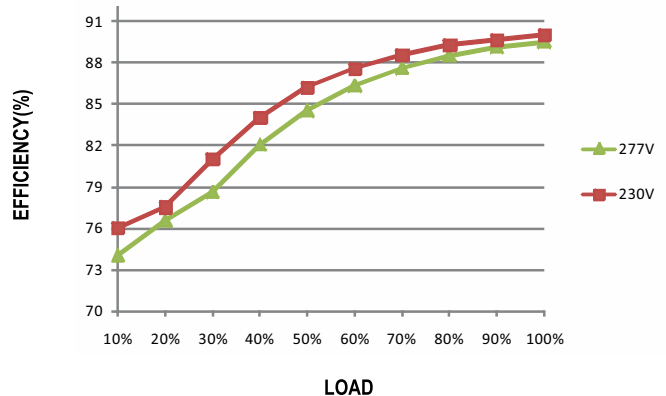

MECHANICAL SPECIFICATION

Unit:mm

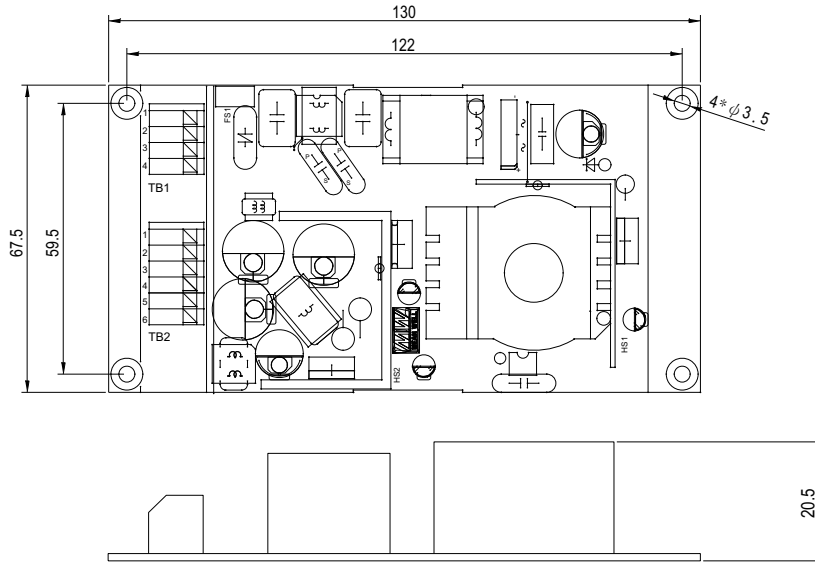

Terminal Pin No. Assignment(TB1)

Pin No.	Assignment
1	ACL
2	ACL
3	ACN
4	ACN

IDPC-65

Terminal Pin No. Assignment(TB2)

Pin No.	Assignment
1	DIM+ (DA+)
2	DIM- (DA-)
3	Vo+
4	Vo-

IDPC-65A

Terminal Pin No. Assignment(TB2)

Pin No.	Assignment	Pin No.	Assignment
1	DIM+	4	Vo-
2	DIM-	5	AUX+
3	Vo+	6	AUX-

INSTALLATION MANUAL

Please refer to :<http://www.meanwell.com/manual.html>