



### ■ Features

- Wide input range 180 ~ 528VAC
- Constant Current mode output
- Metal housing with Class I design
- Built-in active PFC function
- IP67 / IP65 design for indoor or outdoor installations
- Function options: output adjustable via potentiometer; 3 in 1 dimming (dim-to-off) ; Timer dimming
- Typical lifetime > 50000 hours
- 5 years warranty

### ■ Applications

- LED street lighting
- LED high-bay lighting
- Parking space lighting
- LED fishing lamp

### ■ Description

HVGC-100 series is a 100W LED AC/DC LED drive featuring the constant current mode and high voltage output. HVGC-100 operates from 180~528VAC and offers models with different rated current, 350mA and 700mA, respectively. Thanks to the high efficiency up to 91%, with the fanless design, the entire series is able to operate for -40°C ~ +90°C case temperature under free air convection. The design of metal housing and IP67/IP65 ingress protection level allows this series to fit both indoor and outdoor applications. HVGC-100 is equipped with various function options, such as dimming methodologies, so as to provide the optimal design flexibility for LED lighting system.

### ■ Model Encoding

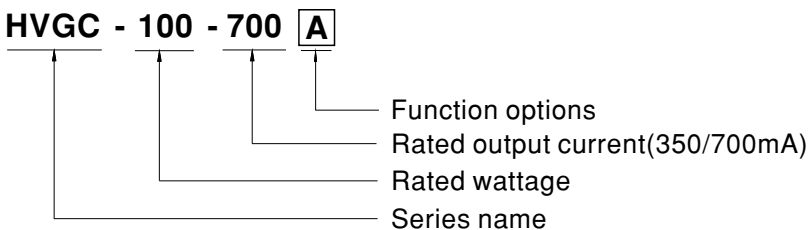

Type	IP Level	Function	Note
A	IP65	Io adjustable through built-in potentiometer.	In Stock
B	IP67	3 in 1 dimming function (0~10Vdc, 10V PWM signal and resistance)	In Stock
AB	IP65	Io adjustable through built-in potentiometer & 3 in 1 dimming function (0~10Vdc, 10V PWM signal and resistance)	In Stock
D	IP67	Timer dimming function, contact MEAN WELL for details(safety pending).	By request



**SPECIFICATION**

MODEL		HVGC-100-350 <input type="checkbox"/>	HVGC-100-700 <input type="checkbox"/>
OUTPUT	RATED CURRENT	350mA	700mA
	RATED POWER	99.75W	99.4W
	CONSTANT CURRENT REGION <small>Note.2</small>	29 ~ 285V	15 ~ 142V
	CURRENT ADJ. RANGE	Adjustable for A/AB-Type only (via built-in potentiometer)	
		210 ~ 350mA	420 ~ 700mA
	CURRENT RIPPLE <small>Note.5</small>	5.0% max. @rated current	
	CURRENT TOLERANCE	± 5.0%	
SET UP TIME <small>Note.4</small>	500ms, 80ms /230VAC, 347VAC, 480VAC		
INPUT	VOLTAGE RANGE <small>Note.3</small>	180 ~ 528VAC 254VDC ~ 747VDC (Please refer to "STATIC CHARACTERISTIC" section)	
	FREQUENCY RANGE	47 ~ 63Hz	
	POWER FACTOR (Typ.)	PF ≥ 0.98/230VAC, PF ≥ 0.98/277VAC, PF ≥ 0.97/347VAC, PF ≥ 0.93/480VAC @full load (Please refer to "POWER FACTOR (PF) CHARACTERISTIC" section)	
	TOTAL HARMONIC DISTORTION	THD < 20% (@ load ≥ 50%/230VAC, 277VAC, 347VAC; @ load ≥ 75%/480VAC) (Please refer to "TOTAL HARMONIC DISTORTION (THD)" section)	
	EFFICIENCY (Typ.)	91%	91%
	AC CURRENT (Typ.)	0.38A / 347VAC	0.28A / 480VAC
	INRUSH CURRENT (Typ.)	COLD START 25A (width=900μs measured at 50% I <sub>peak</sub> ) at 480VAC; Per NEMA 410	
	MAX. No. of PSUs on 16A CIRCUIT BREAKER	5 units (circuit breaker of type B) / 8 units (circuit breaker of type C) at 480VAC	
LEAKAGE CURRENT	<0.75mA / 480VAC		
PROTECTION	SHORT CIRCUIT	Constant current limiting, recovers automatically after fault condition is removed	
	OVER VOLTAGE	300 ~ 320V	150 ~ 160V
	OVER TEMPERATURE	Shut down o/p voltage with auto-recovery or re-power on to recovery	
ENVIRONMENT	WORKING TEMP.	T <sub>case</sub> = -40 ~ +90°C (Please refer to "OUTPUT LOAD vs TEMPERATURE" section)	
	MAX. CASE TEMP.	T <sub>case</sub> = +90°C	
	WORKING HUMIDITY	20 ~ 95% RH non-condensing	
	STORAGE TEMP., HUMIDITY	-40 ~ +80°C, 10 ~ 95% RH	
	TEMP. COEFFICIENT	± 0.03%/°C (0 ~ 60°C)	
	VIBRATION	10 ~ 500Hz, 5G 12min./1cycle, period for 72min. each along X, Y, Z axes	
SAFETY & EMC	SAFETY STANDARDS	UL8750, CSA C22.2 No. 250.0-08, TUV EN61347-1, EN61347-2-13, EAC TP TC 004, IP65 or IP67 approved; design refer to UL60950-1, TUV EN60950-1	
	WITHSTAND VOLTAGE	I/P-O/P: 3.75KVAC I/P-FG: 2KVAC O/P-FG: 1.5KVAC	
	ISOLATION RESISTANCE	I/P-O/P, I/P-FG, O/P-FG: 100M Ohms / 500VDC / 25°C / 70% RH	
	EMC EMISSION	Compliance to EN55015, EN61000-3-2 Class C (@ load ≥ 50%); EN61000-3-3, FCC Part 15 Subpart, EAC TP TC 020	
EMC IMMUNITY	Compliance to EN61000-4-2, 3, 4, 5, 6, 8, 11, EN61547, light industry level (surge immunity Line-Earth 4KV, Line-Line 2KV), EAC TP TC 020		
OTHERS	MTBF	186.1K hrs min. MIL-HDBK-217F (25°C)	
	DIMENSION	236*68*38.8mm (L*W*H)	
	PACKING	1.18Kg; 12pcs/15.2Kg/0.74CUFT	
NOTE	<ol style="list-style-type: none"> <li>All parameters NOT specially mentioned are measured at 347VAC input, rated current and 25°C of ambient temperature.</li> <li>Please refer to "DRIVING METHODS OF LED MODULE".</li> <li>De-rating may be needed under low input voltages. Please refer to "STATIC CHARACTERISTIC" sections for details.</li> <li>Length of set up time is measured at first cold start. Turning ON/OFF the driver may lead to increase of the set up time.</li> <li>It is measured 50% ~ 100% of maximum voltage under rated power delivery.</li> <li>The driver is considered as a component that will be operated in combination with final equipment. Since EMC performance will be affected by the complete installation, the final equipment manufacturers must re-qualify EMC Directive on the complete installation again.</li> <li>To fulfill requirements of the latest ErP regulation for lighting fixtures, this LED driver can only be used behind a switch without permanently connected to the mains.</li> <li>This series meets the typical life expectancy of &gt;50,000 hours of operation when T<sub>case</sub>, particularly (T<sub>c</sub>) point (or TMP, per DLC), is about 80°C or less.</li> <li>Please refer to the warranty statement on MEAN WELL's website at <a href="http://www.meanwell.com">http://www.meanwell.com</a>.</li> <li>The ambient temperature derating of 3.5°C/1000m with fanless models and of 5°C/1000m with fan models for operating altitude higher than 2000m(6500ft).</li> <li>For any application note and IP water proof function installation caution, please refer our user manual before using. <a href="https://www.meanwell.com/Upload/PDF/LED_EN.pdf">https://www.meanwell.com/Upload/PDF/LED_EN.pdf</a></li> </ol>		

### Block Diagram

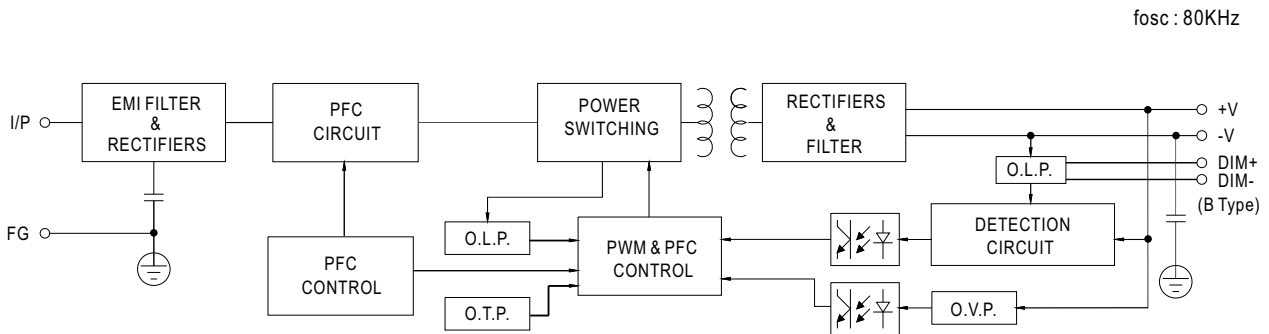

### DRIVING METHODS OF LED MODULE

※ This series works in constant current mode to directly drive the LEDs.

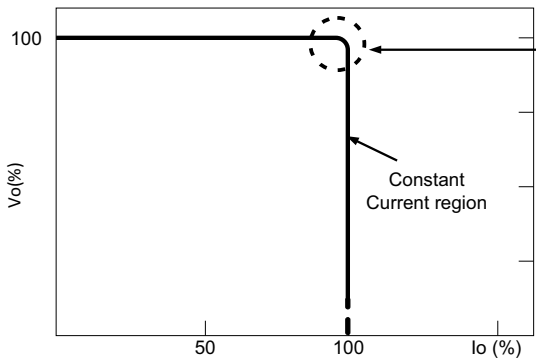

Typical output current normalized by rated current (%)

In the constant current region, the highest voltage at the output of the driver depends on the configuration of the end systems.

Should there be any compatibility issues, please contact MEAN WELL.

## ■ DIMMING OPERATION

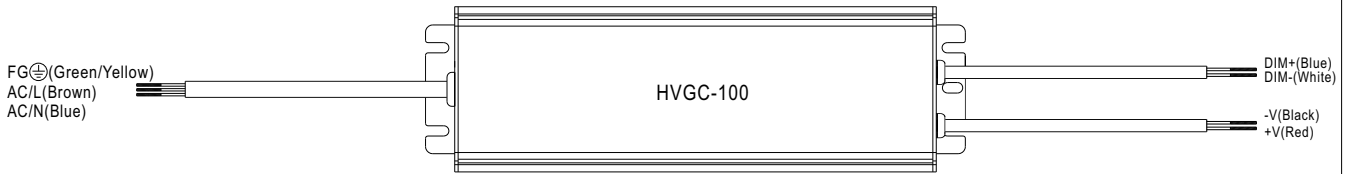

### ※ 3 in 1 dimming function (for B/AB-Type)

- Output constant current level can be adjusted by applying one of the three methodologies between DIM+ and DIM-: 0 ~ 10VDC, or 10V PWM signal or resistance.
- Direct connecting to LEDs is suggested. It is not suitable to be used with additional drivers.
- Dimming source current from power supply: 100 $\mu$ A (typ.)

#### ◎ Applying additive 0 ~ 10VDC

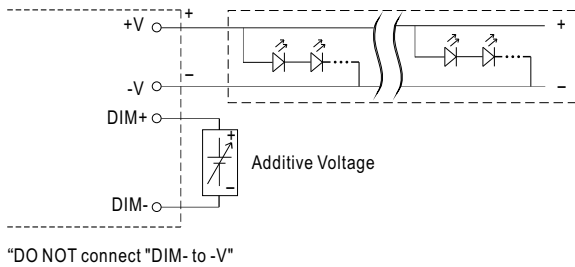

#### ◎ Applying additive 10V PWM signal (frequency range 100Hz ~ 3KHz):

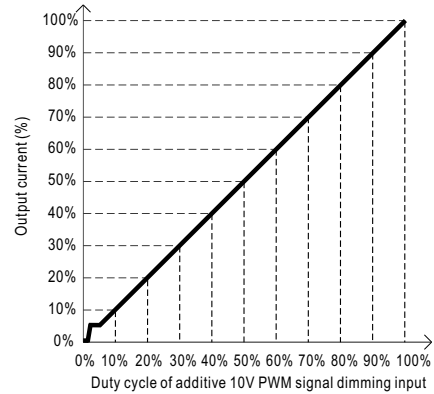
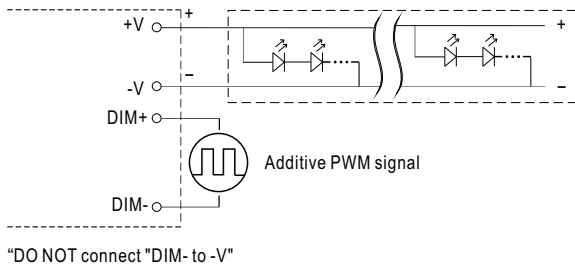

#### ◎ Applying additive resistance:

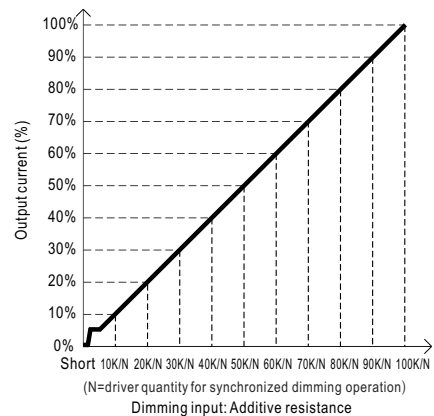
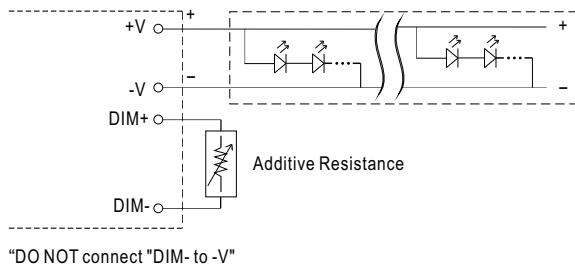

Note : 1. Min. dimming level is about 8% and the output current is not defined when  $0\% < I_{out} < 8\%$ .

2. The output current could drop down to 0% when dimming input is about  $0k\Omega$  or 0Vdc, or 10V PWM signal with 0% duty cycle.

### OUTPUT LOAD vs TEMPERATURE(Note.9)

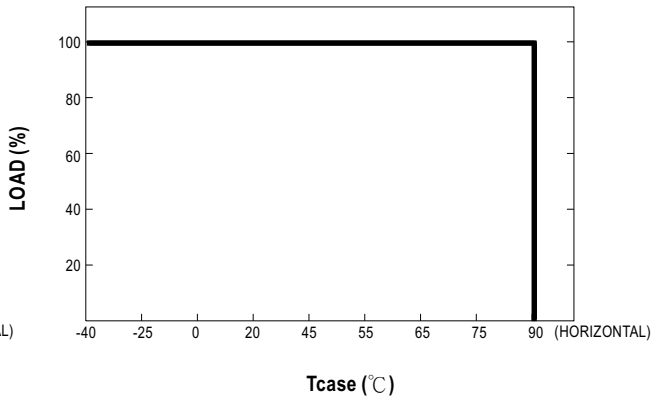
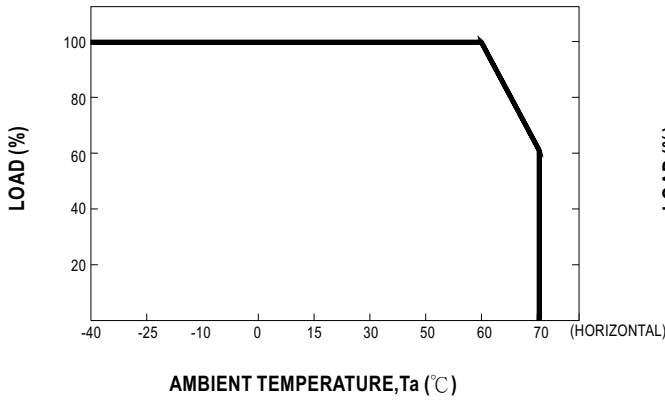

### STATIC CHARACTERISTIC

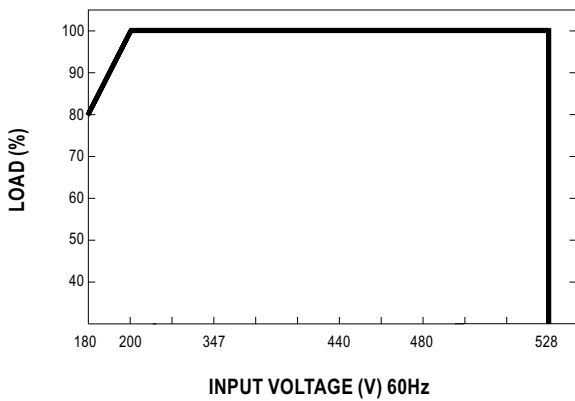

※ De-rating is needed under low input voltage.

### TOTAL HARMONIC DISTORTION (THD)

※ 700mA Model, Tcase at 80°C

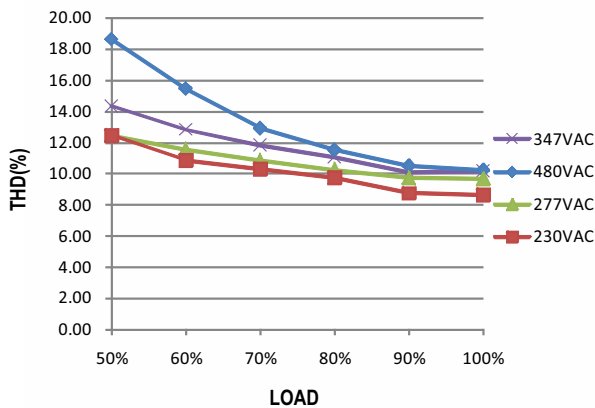

### POWER FACTOR (PF) CHARACTERISTIC

※ Tcase at 80°C

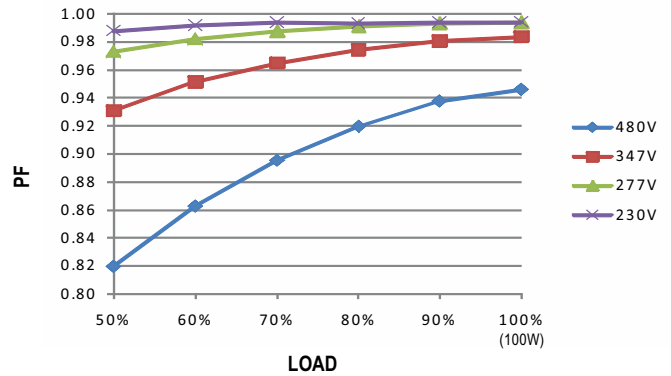

### EFFICIENCY vs LOAD

HVGC-100 series possess superior working efficiency that up to 91% can be reached in field applications.

※ 700mA Model, Tcase at 80°C

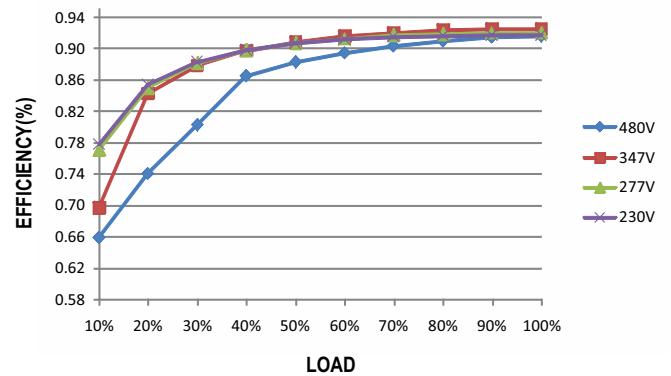

■ LIFE TIME

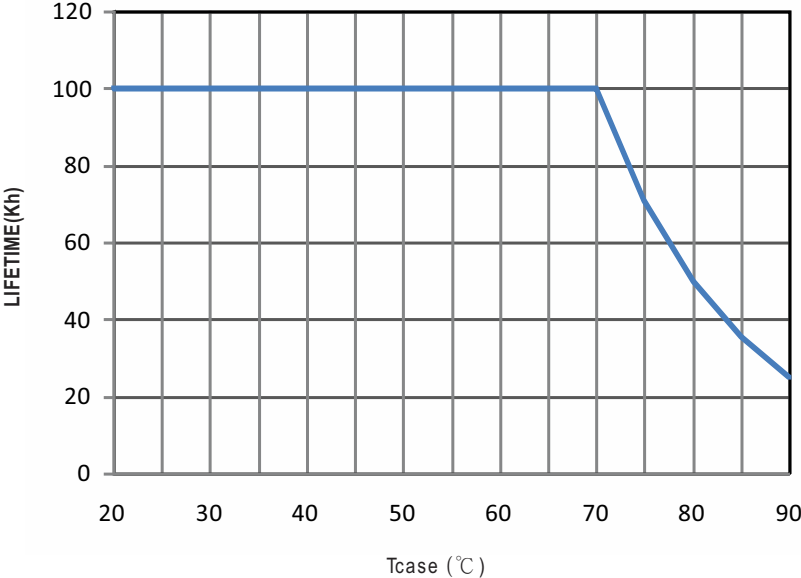

MECHANICAL SPECIFICATION

Case No. 994 Unit:mm

※ A-Type

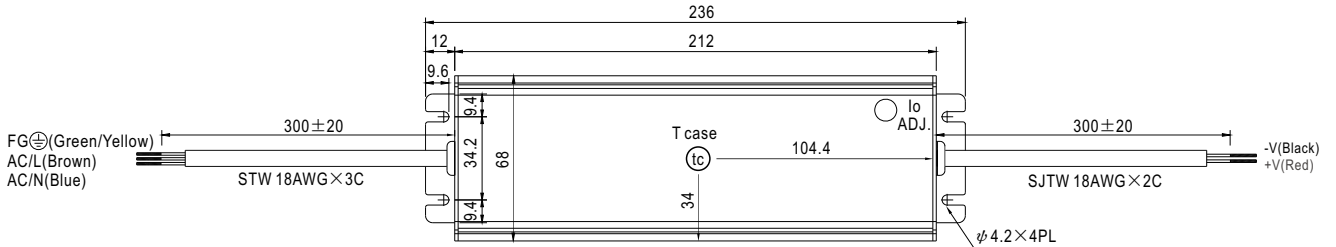

• (tc) : Max. Case Temperature



※ B-Type

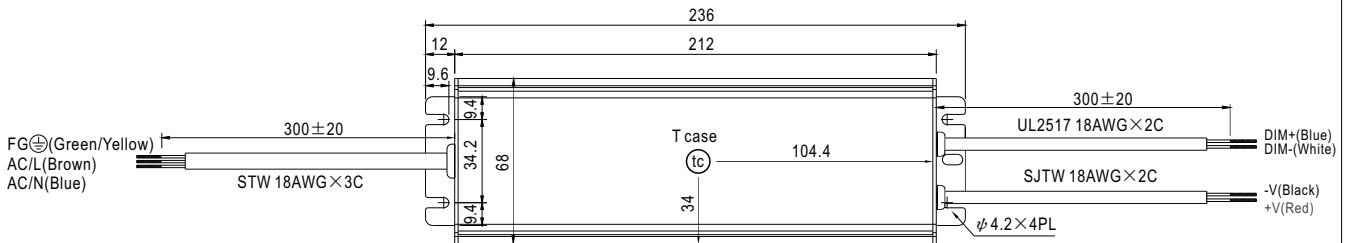

• (tc) : Max. Case Temperature



※ AB-Type

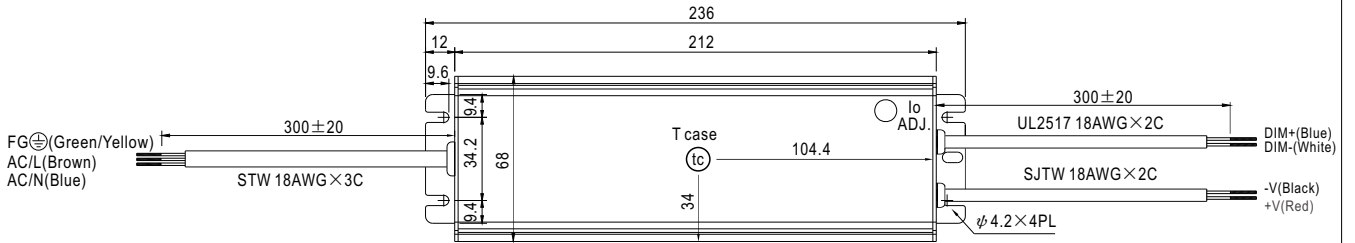

• (tc) : Max. Case Temperature

※ D-Type

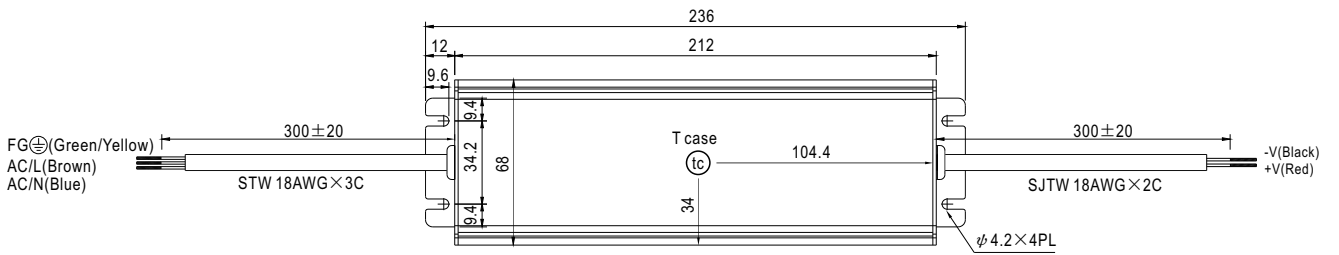

• (tc) : Max. Case Temperature



## ■ WATERPROOF CONNECTION

### ※ Waterproof connector

Waterproof connector can be assembled on the output cable of HVGC-100 to operate in dry/wet/damp or outdoor environment.

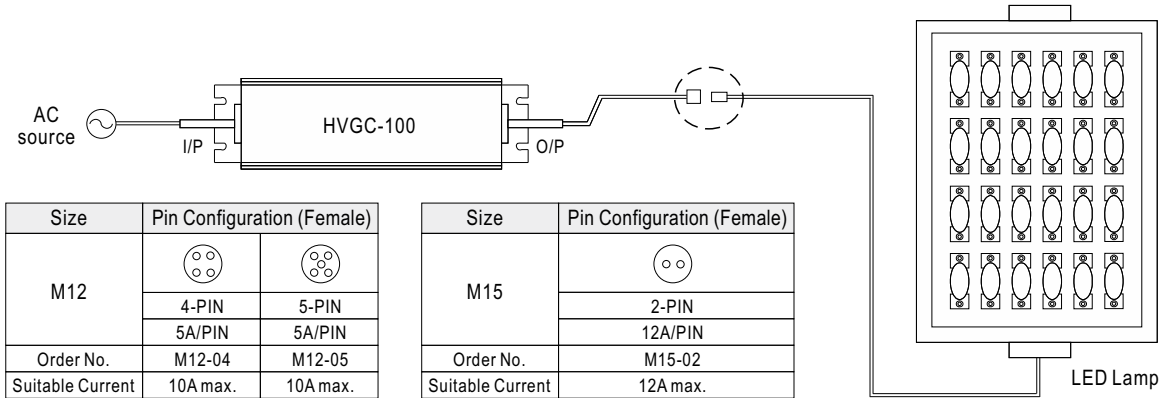

### ※ Cable Joiner

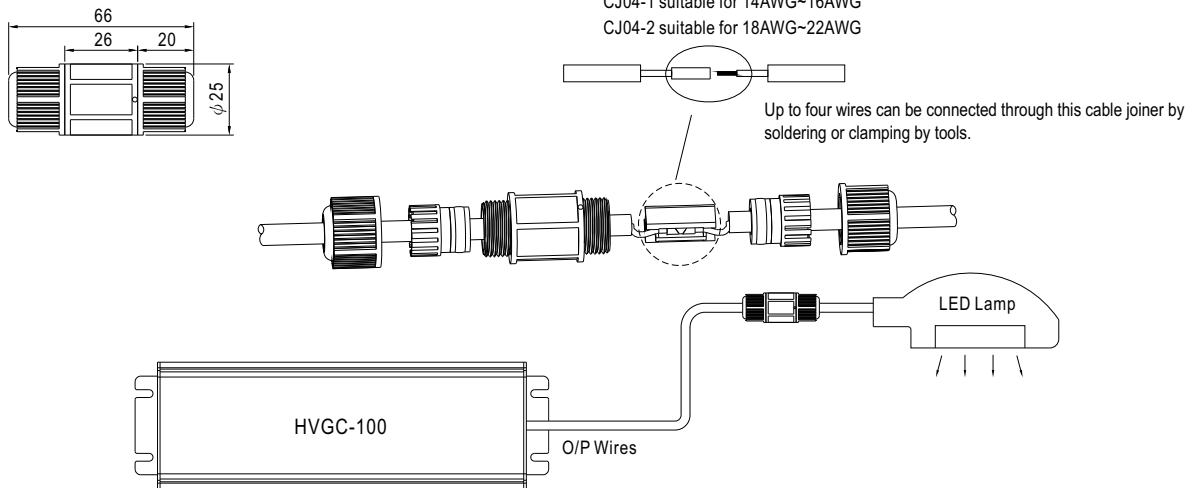

◎ CJ04 cable joiner can be purchased independently for user's own assembly.  
MEAN WELL order No. : CJ04-1, CJ04-2.

### ※ Junction Box Option

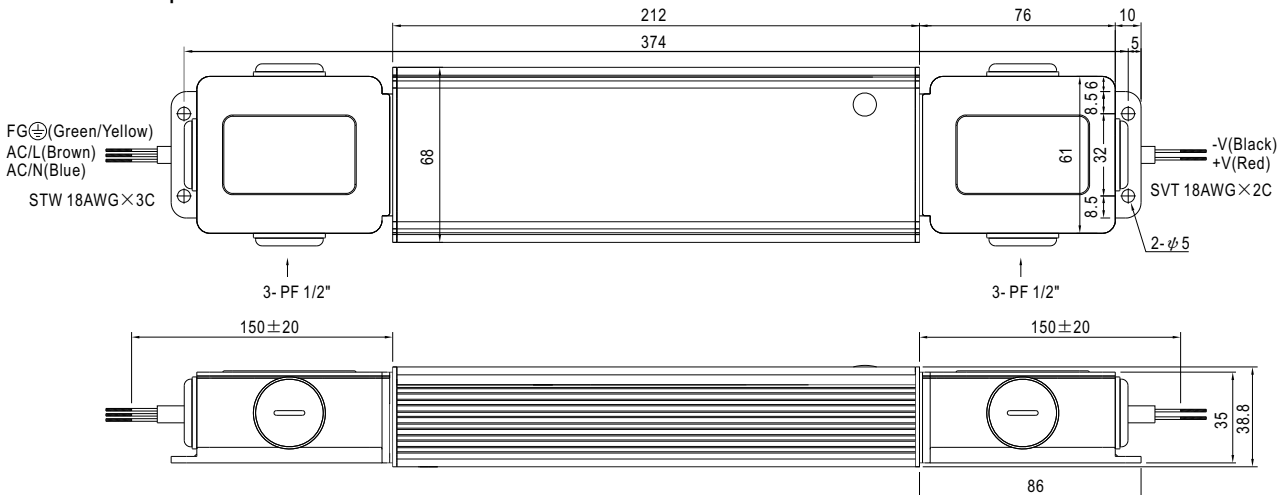

◎ Junction box option is available for A - Type. Please contact MEAN WELL for details.

## ■ INSTALLATION MANUAL

Please refer to : <http://www.meanwell.com/manual.html>