

GENE-WHU6

3.5" Subcompact Board

User's Manual 2nd Ed

Copyright Notice

This document is copyrighted, 2020. All rights are reserved. The original manufacturer reserves the right to make improvements to the products described in this manual at any time without notice.

No part of this manual may be reproduced, copied, translated, or transmitted in any form or by any means without the prior written permission of the original manufacturer. Information provided in this manual is intended to be accurate and reliable. However, the original manufacturer assumes no responsibility for its use, or for any infringements upon the rights of third parties that may result from its use.

The material in this document is for product information only and is subject to change without notice. While reasonable efforts have been made in the preparation of this document to assure its accuracy, AAEMON assumes no liabilities resulting from errors or omissions in this document, or from the use of the information contained herein.

AAEMON reserves the right to make changes in the product design without notice to its users.

Acknowledgement

All other products' name or trademarks are properties of their respective owners.

- Microsoft Windows is a registered trademark of Microsoft Corp.
- Intel, Pentium, Celeron, and Xeon are registered trademarks of Intel Corporation
- Core, Atom are trademarks of Intel Corporation
- ITE is a trademark of Integrated Technology Express, Inc.
- IBM, PC/AT, PS/2, and VGA are trademarks of International Business Machines Corporation.

All other product names or trademarks are properties of their respective owners.

Packing List

Before setting up your product, please make sure the following items have been shipped:

Item	Quantity
GENE-WHU6 with Heat-spreader	1

If any of these items are missing or damaged, please contact your distributor or sales representative immediately.

About this Document

This User's Manual contains all the essential information, such as detailed descriptions and explanations on the product's hardware and software features (if any), its specifications, dimensions, jumper/connector settings/definitions, and driver installation instructions (if any), to facilitate users in setting up their product.

Users may refer to the product page at AAEON.com for the latest version of this document.

Safety Precautions

Please read the following safety instructions carefully. It is advised that you keep this manual for future references

1. All cautions and warnings on the device should be noted.
2. Make sure the power source matches the power rating of the device.
3. Position the power cord so that people cannot step on it. Do not place anything over the power cord.
4. Always completely disconnect the power before working on the system's hardware.
5. No connections should be made when the system is powered as a sudden rush of power may damage sensitive electronic components.
6. If the device is not to be used for a long time, disconnect it from the power supply to avoid damage by transient over-voltage.
7. Always disconnect this device from any AC supply before cleaning.
8. While cleaning, use a damp cloth instead of liquid or spray detergents.
9. Make sure the device is installed near a power outlet and is easily accessible.
10. Keep this device away from humidity.
11. Place the device on a solid surface during installation to prevent falls
12. Do not cover the openings on the device to ensure optimal heat dissipation.
13. Watch out for high temperatures when the system is running.
14. Do not touch the heat sink or heat spreader when the system is running
15. Never pour any liquid into the openings. This could cause fire or electric shock.
16. As most electronic components are sensitive to static electrical charge, be sure to ground yourself to prevent static charge when installing the internal components. Use a grounding wrist strap and contain all electronic components in any static-shielded containers.

17. If any of the following situations arises, please the contact our service personnel:
 - i. Damaged power cord or plug
 - ii. Liquid intrusion to the device
 - iii. Exposure to moisture
 - iv. Device is not working as expected or in a manner as described in this manual
 - v. The device is dropped or damaged
 - vi. Any obvious signs of damage displayed on the device
18. **DO NOT LEAVE THIS DEVICE IN AN UNCONTROLLED ENVIRONMENT WITH TEMPERATURES BEYOND THE DEVICE'S PERMITTED STORAGE TEMPERATURES (SEE CHAPTER 1) TO PREVENT DAMAGE.**

Warning!



This device complies with Part 15 FCC Rules. Operation is subject to the following two conditions: (1) this device may not cause harmful interference, and (2) this device must accept any interference received including interference that may cause undesired operation.

Caution:

There is a danger of explosion if the battery is incorrectly replaced. Replace only with the same or equivalent type recommended by the manufacturer. Dispose of used batteries according to the manufacturer's instructions and your local government's recycling or disposal directives.

Attention:

Il y a un risque d'explosion si la batterie est remplacée de façon incorrecte. Ne la remplacer qu'avec le même modèle ou équivalent recommandé par le constructeur. Recycler les batteries usées en accord avec les instructions du fabricant et les directives gouvernementales de recyclage.

China RoHS Requirements (CN)

产品中有毒有害物质或元素名称及含量

AAEON Main Board/ Daughter Board/ Backplane

部件名称	有毒有害物质或元素					
	铅 (Pb)	汞 (Hg)	镉 (Cd)	六价铬 (Cr(VI))	多溴联苯 (PBB)	多溴二苯醚 (PBDE)
印刷电路板 及其电子组件	○	○	○	○	○	○
外部信号 连接器及线材	○	○	○	○	○	○
<p>○: 表示该有毒有害物质在该部件所有均质材料中的含量均在 SJ/T 11363-2006 标准规定的限量要求以下。</p> <p>X: 表示该有毒有害物质至少在该部件的某一均质材料中的含量超出 SJ/T 11363-2006 标准规定的限量要求。</p> <p>备注: 此产品所标示之环保使用期限, 系指在一般正常使用状况下。</p>						

China RoHS Requirement (EN)

Poisonous or Hazardous Substances or Elements in Products

AAEON Main Board/ Daughter Board/ Backplane

Component	Poisonous or Hazardous Substances or Elements					
	Lead (Pb)	Mercury (Hg)	Cadmium (Cd)	Hexavalent Chromium (Cr(VI))	Polybrominated Biphenyls (PBB)	Polybrominated Diphenyl Ethers (PBDE)
PCB & Other Components	○	○	○	○	○	○
Wires & Connectors for External Connections	○	○	○	○	○	○
<p>O: The quantity of poisonous or hazardous substances or elements found in each of the component's parts is below the SJ/T 11363-2006-stipulated requirement.</p> <p>X: The quantity of poisonous or hazardous substances or elements found in at least one of the component's parts is beyond the SJ/T 11363-2006-stipulated requirement.</p> <p>Note: The Environment Friendly Use Period as labeled on this product is applicable under normal usage only</p>						

Table of Contents

Chapter 1 - Product Specifications	1
1.1 Specifications	2
Chapter 2 – Hardware Information	5
2.1 Dimensions	6
2.2 Jumpers and Connectors.....	10
2.3 List of Jumpers	11
2.3.1 Front Panel Connector (JP1).....	11
2.3.2 COM2 Pin8 Function Selection (JP3)	12
2.3.3 LVDS Port Backlight Inverter VCC Selection (JP4).....	12
2.3.4 LVDS Port Backlight Lightness Control Mode Selection (JP5)	12
2.3.5 Touch Screen 4,5,8 Wire Selection (JP8)	13
2.3.6 Clear CMOS Jumper (JP9).....	13
2.3.7 Auto Power Button Enable/Disable Selection (JP10)	13
2.4 List of Connectors.....	14
2.4.1 +5V Output for SATA HDD (CN1).....	15
2.4.2 SATA Port (CN2)	15
2.4.3 External Power Input (CN3).....	16
2.4.4 Audio I/O Port (CN5)	16
2.4.5 External +5VSB Input (CN6)	17
2.4.6 DDR SO-DIMM Slot (CN7).....	17
2.4.7 COM Port 1 (CN8).....	18
2.4.8 COM Port 2 (CN9).....	20
2.4.9 Mini-Card Slot (Full-Mini Card) (CN10).....	22
2.4.10 DDR SO-DIMM Slot (CN11).....	24
2.4.11 M.2 E-Key 2230 (CN12).....	24
2.4.12 LVDS Port Inverter /Backlight Connector (CN3).....	24

2.4.13	LVDS Port (CN14)	25
2.4.14	USB 2.0 Port 5 (CN15)	26
2.4.15	BIOS Debug Port (CN16)	27
2.4.16	USB 2.0 Port 6 (CN17)	28
2.4.17	LPC Port (CN18).....	28
2.4.18	Digital I/O Port (CN19).....	29
2.4.19	Nano SIM Card Socket (CN20)	29
2.4.20	Touchscreen Connector (Optional) (CN21).....	30
2.4.21	CPU Fan (CN22)	32
2.4.22	Battery Connector (CN23)	33
2.4.23	LAN (RJ-45) Port 1/Port 2 (CN24/CN25)	33
2.4.24	USB 3.2 Gen 2 Ports 0 & 1 (CN26)	34
2.4.25	USB 3.2 Gen 2 Ports 2 & 3 (CN27).....	35
2.4.26	HDMI (CN28).....	36
2.4.27	VGA Port (CN29).....	37
2.4.28	M.2 B-Key 2280 (CN30).....	37
2.4.29	LAN SPD Connector (CN31)	38
2.5	Assembly Options	39
2.6	Block Diagram.....	41
Chapter 3	- AMI BIOS Setup	42
3.1	System Test and Initialization	43
3.2	AMI BIOS Setup	44
3.3	Setup Submenu: Main	45
3.4	Setup Submenu: Advanced.....	46
3.4.1	Advanced: Trusted Computing	47
3.4.2	Advanced: CPU Configuration.....	49
3.4.3	Advanced: SATA Configuration	50
3.4.4	Advanced: Hardware Monitor.....	51

3.4.4.1	Smart Fan Mode Configuration	52
3.4.5	Advanced: SIO Configuration	56
3.4.5.1	Serial Port 1 Configuration	57
3.4.5.2	Serial Port 2 Configuration	58
3.4.6	Advanced: Power Management	59
3.4.7	Advanced: Digital IO Port Configuration	60
3.5	Setup submenu: Chipset.....	61
3.5.1	Chipset: System Agent (SA) Configuration.....	62
3.5.1.1	LVDS Panel Configuration	63
3.5.2	Chipset: PCH IO Configuration	65
3.5.2.1	Serial IO Configuration	66
3.6	Setup submenu: Security	67
3.6.1	Security: Secure Boot	68
3.6.1.1	Key Management.....	69
3.7	Setup submenu: Boot.....	71
3.7.1	Boot: BBS Priorities	72
3.8	Setup submenu: Save & Exit	73
Chapter 4 – Driver Installation	74	
4.1	Driver Download/Installation	75
Appendix A - I/O Information.....	77	
A.1	I/O Address Map	78
A.2	Memory Address Map	79
A.3	IRQ Mapping Chart.....	80
Appendix B – Mating Connectors and Cables.....	82	
B.1	Mating Connectors and Cables.....	83

Chapter 1

Product Specifications

1.1 Specifications

System

Form Factor	3.5" Subcompact Board
CPU	Intel® 8th Generation Core™ i7/i5/i3/Celeron SoC i7-8665UE (4C, 1.7GHz, up to 4.4GHz) i5-8365UE (4C, 1.6GHz, up to 4.1GHz) i3-8145UE (2C, 2.2GHz, up to 3.9GHz) Celeron 4305UE (2C, 2GHz)
CPU Frequency	Up to 4.4GHz
Chipset	8th Generation Intel® Processor SoC
Memory Type	2400 MHz Dual Channel DDR4 (Non-ECC) SODIMM x 2
Max. Memory Capacity	Up to 64GB
BIOS	UEFI
Wake on LAN	Yes
Watchdog Timer	255 Levels
Power Requirement	+9-36V (Optional: +12V)
Power Supply Type	AT/ATX
Power Consumption (Typical)	Intel® i7-8665UE, DDR4 2400 MHz 16GB, 2.8A@ +12V
Dimension (L x W)	5.75" x 4" (146mm x 101.7mm)
Operating Temperature	32°F ~ 140°F (0°C ~ 60°C)

System

Storage Temperature	-40°F ~ 176°F (-40°C ~ 81°C)
Operating Humidity	0% ~ 90% relative humidity, non-condensing
MTBF (Hours)	354,194
Certification	CE/FCC

Display

VGA/LCD Controller	Intel® 8th Generation Core™ i7/i5/i3/Celeron SoC
Video Output	LVDS/eDP x 1 (Default: LVDS) VGA x 1 HDMI 2.0 x 1
Backlight inverter supply	Yes

I/O

Ethernet	Intel® i210/i211 & i219, 10/100/1000Base, RJ 45 x2
Audio	High Definition Audio Interface
USB Port	USB 3.2 Gen 2 x 4 USB 2.0 x 2 (Up to Gen2)
Serial Port	RS-232/422/485 x 2
Parallel Port	—
HDD Interface	SATA 3.0 x 1 +5V SATA power connector x 1
FDD Interface	—

I/O

SSD	Full size mSATA/mPCIe x 1 with Nano-SIM (mSATA as default, select by BIOS) M.2 2280 B-key (PCIe as default, SATA select by BIOS)
Expansion Slot	M.2 2230 E key x 1 (For Wi-Fi/Bluetooth, PCIe/USB signal only) SMBUS/I2C/LPC/eSPI x 1
DIO	8 Bit
SIM	Nano-SIM slot x 1
TPM	—
Touch	x 1

Chapter 2

Hardware Information

2.1 Dimensions

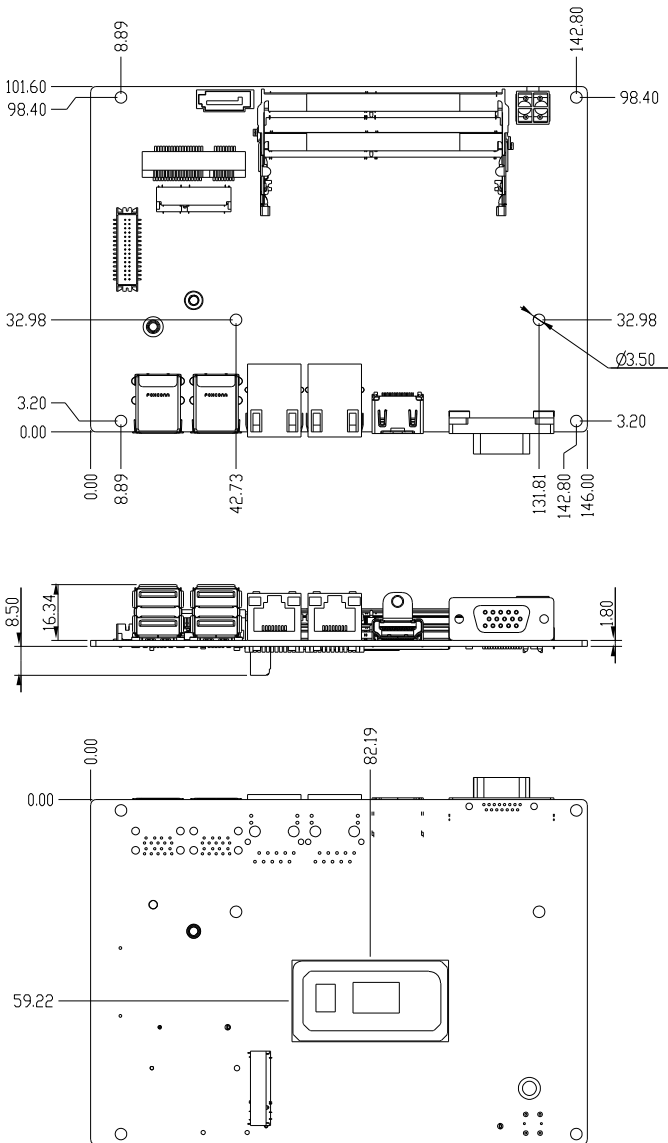

With Fan Option (Part No. GENE-WHU6-FAN01)

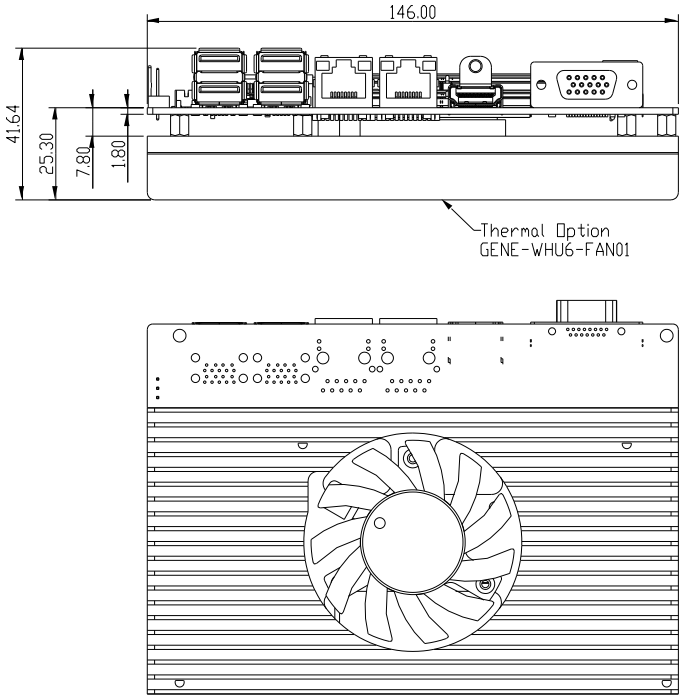

With Heatsink Option (Part No. GENE-WHU6-HSK01)

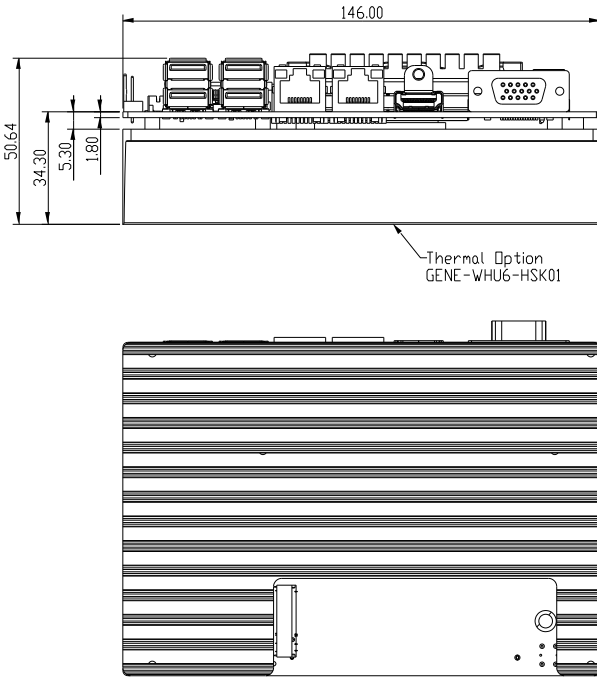

With Heatsink Option (Part No. GENE-WHU6-HSK02)

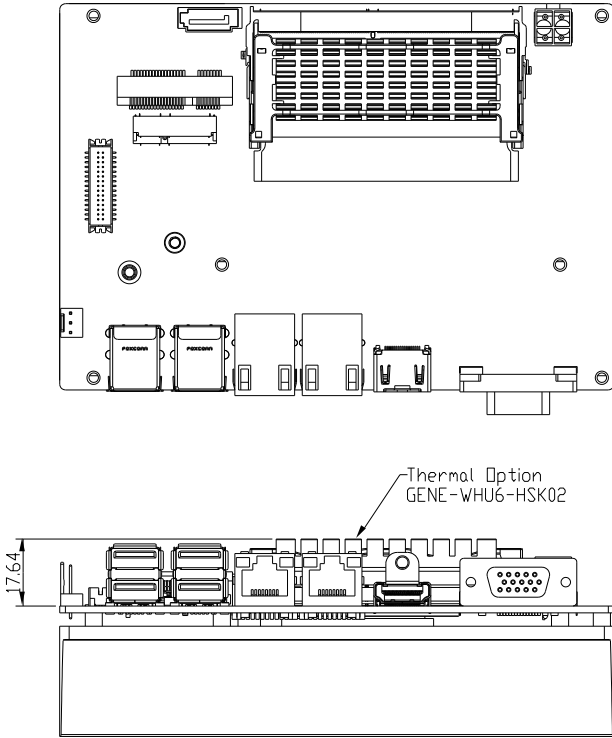

2.2 Jumpers and Connectors

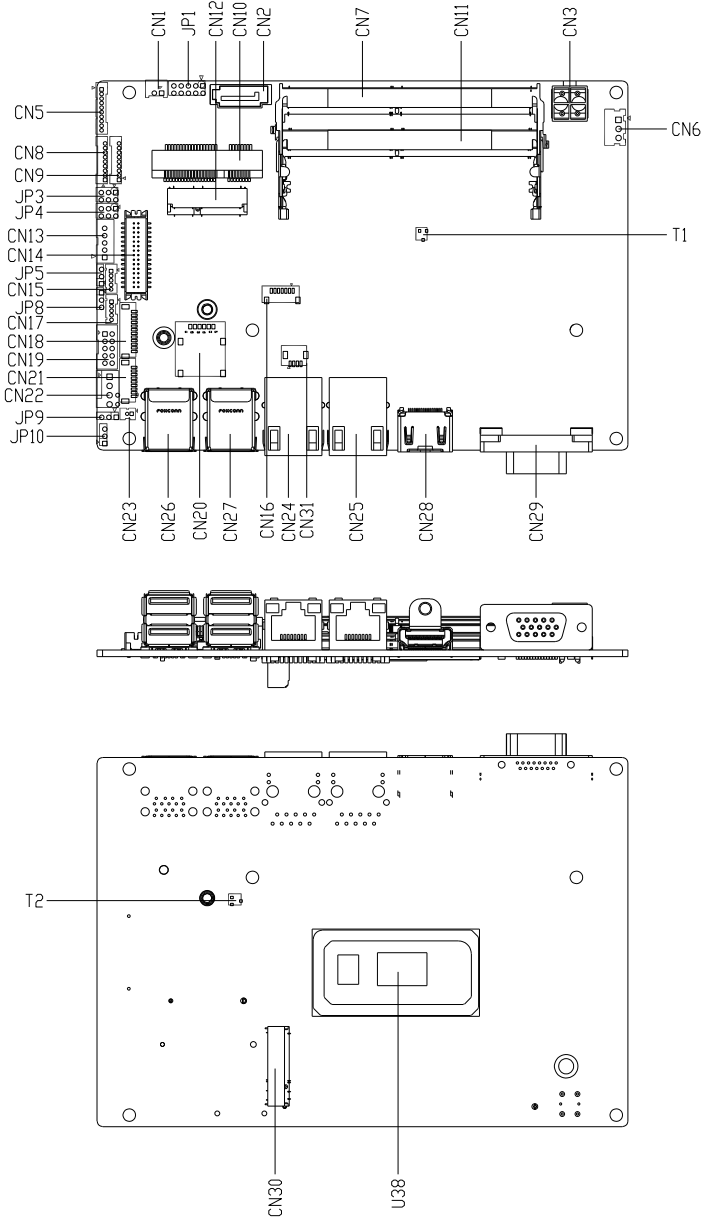

2.3 List of Jumpers

Please refer to the table below for all of the board's jumpers that you can configure for your application

Label	Function
JP1	Front Panel Connector
JP3	COM2 Pin8 Function Selection
JP4	LVDS Port Backlight Inverter VCC Selection and Operating VDD Selection
JP5	LVDS Port2 Backlight Lightness Control Mode Selection
JP8	Touch Screen 4/5/8-wire Mode Selection
JP9	Clear CMOS Jumper
JP10	Auto Power Button Enable/Disable Selection

2.3.1 Front Panel Connector (JP1)

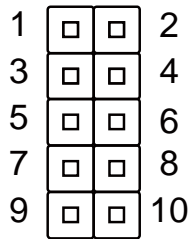

Pin	Function	Pin	Function
Pin 1	PWR_BTN-	Pin 2	PWR_BTN+
Pin 3	HDD_LED-	Pin 4	HDD_LED+
Pin 5	SPEAKER-	Pin 6	SPEAKER+
Pin 7	PWR_LED-	Pin 8	PWR_LED+
Pin 9	H/W RESET-	Pin 10	H/W RESET+

2.3.2 COM2 Pin8 Function Selection (JP3)

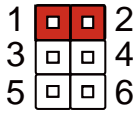

+12V

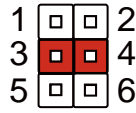

Ring (Default)

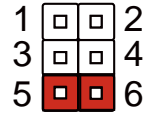

+5V

2.3.3 LVDS Port Backlight Inverter VCC Selection (JP4)

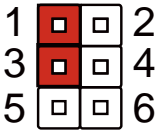

+12V

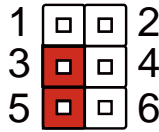

+5V (Default)

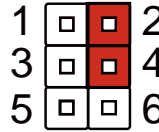

+3.3V (Default)

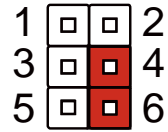

+5V

Note: JP2 Default is two (2) jumpers placed on pins 3-5 and pins 2-4.

2.3.4 LVDS Port Backlight Lightness Control Mode Selection (JP5)

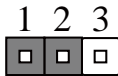

VR Mode

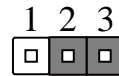

PWM Mode (Default)

2.3.5 Touch Screen 4,5,8 Wire Selection (JP8)

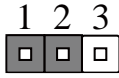

4/8 Wires Mode (Default)

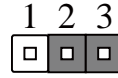

5 Wires Mode

2.3.6 Clear CMOS Jumper (JP9)

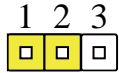

Normal (Default)

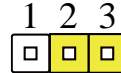

Clear CMOS

2.3.7 Auto Power Button Enable/Disable Selection (JP10)

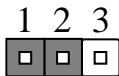

Disable/ATX

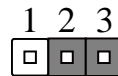

Enable/AT (Default)

Note: When disabled, use Power Button JP5 (pins 1-2) to power on the system.

2.4 List of Connectors

Please refer to the table below for all of the board's connectors that you can configure for your application

Label	Function
CN1	+5V Output for SATA HDD
CN2	SATA Port
CN3	External Power Input
CN5	Audio I/O Port
CN6	External +5VSB Input
CN7	DDR4 SO-DIMM Slot
CN8	COM Port 1 RS-232/422/485
CN9	COM Port 2 RS-232/422/485
CN10	Mini-Card Slot (Full-Size)
CN11	DDR4 SO-DIMM Slot
CN12	M.2 E-Key 2230
CN13	LVDS Port Inverter /Backlight Connector
CN14	LVDS Port
CN15	USB 2.0 Port 5
CN16	SPI Debug Port
CN17	USB 2.0 Port 6
CN18	LPC Port
CN19	Digital I/O Port
CN20	Nano SIM Card Socket
CN21	Touch Screen Connector (Optional)
CN22	CPU FAN
CN23	Battery Connector
CN24	LAN (RJ-45) Port2

Label	Function
CN25	LAN (RJ-45) Port1
CN26	Dual USB3.1 Port 0/Port 1
CN27	Dual USB3.1 Port 2/Port 3
CN28	HDMI Connector
CN29	VGA Port
CN30	M.2 B-Key 2280
CN31	LAN SDP CONN

2.4.1 +5V Output for SATA HDD (CN1)

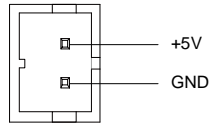

Pin	Pin Name	Signal Type	Signal Level
1	+5V	PWR	+5V
2	GND	GND	

2.4.2 SATA Port (CN2)

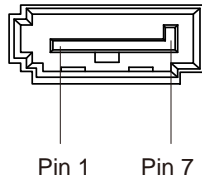

Pin	Pin Name	Signal Type	Signal Level
1	GND	GND	
2	SATA_TX+	DIFF	
3	SATA_TX-	DIFF	

Pin	Pin Name	Signal Type	Signal Level
4	GND	GND	
5	SATA_RX-	DIFF	
6	SATA_RX+	DIFF	
7	GND	GND	

2.4.3 External Power Input (CN3)

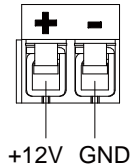

Pin	Pin Name	Signal Type	Signal Level
1	+12V	PWR	+9~+36V (or +12V)
2	GND	GND	

Note: There are two types of power input, 9~36V or 12V only; by BOM change.

2.4.4 Audio I/O Port (CN5)

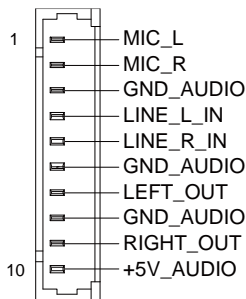

Pin	Pin Name	Signal Type	Signal Level
1	MIC_L	IN	
2	MIC_R	IN	

Pin	Pin Name	Signal Type	Signal Level
3	GND_AUDIO	GND	
4	LINE_L_IN	IN	
5	LINE_R_IN	IN	
6	GND_AUDIO	GND	
7	LEFT_OUT	OUT	
8	GND_AUDIO	GND	
9	RIGHT_OUT	OUT	
10	+5V_AUDIO	PWR	+5V

2.4.5 External +5VSB Input (CN6)

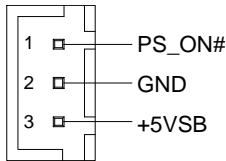

Pin	Pin Name	Signal Type	Signal Level
1	PS_ON#	OUT	+5V
2	GND	GND	
3	+5VSB	PWR	+5V

2.4.6 DDR SO-DIMM Slot (CN7)

Standard Specifications

2.4.7 COM Port 1 (CN8)

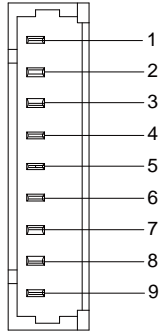

RS-232			
Pin	Pin Name	Signal Type	Signal Level
1	DCD1	IN	
2	DSR1	IN	
3	RX1	IN	
4	RTS1	OUT	±5V
5	TX1	OUT	±5V
6	CTS1	IN	
7	DTR1	OUT	±5V
8	RI1/+5V/+12V	IN	+5V/+12V
9	GND	GND	

RS-485			
Pin	Pin Name	Signal Type	Signal Level
1	RS485_D-	I/O	±5V
2	NC		
3	RS485_D+	I/O	±5V
4	NC		
5	NC		
6	NC		
7	NC		
8	NC/+5V/+12V	PWR	+5V/+12V
9	GND	GND	

RS-422			
Pin	Pin Name	Signal Type	Signal Level
1	RS422_TX-	OUT	±5V
2	NC		
3	RS422_TX+	OUT	±5V
4	NC		
5	RS422_RX+	IN	
6	NC		
7	RS422_RX-	IN	
8	NC/+5V/+12V	PWR	+5V/+12V
9	GND	GND	

2.4.8 COM Port 2 (CN9)

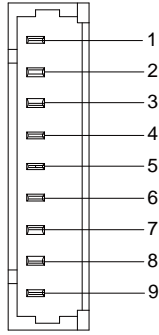

RS-232			
Pin	Pin Name	Signal Type	Signal Level
1	DCD2	IN	
2	DSR2	IN	
3	RX2	IN	
4	RTS2	OUT	±5V
5	TX2	OUT	±5V
6	CTS2	IN	
7	DTR2	OUT	±5V
8	RI2/+5V/+12V	IN	+5V/+12V
9	GND	GND	

RS-485			
Pin	Pin Name	Signal Type	Signal Level
1	RS485_D2-	I/O	±5V
2	NC		
3	RS485_D2+	I/O	±5V
4	NC		
5	NC		
6	NC		
7	NC		
8	NC/+5V/+12V	PWR	+5V/+12V
9	GND	GND	

RS-422			
Pin	Pin Name	Signal Type	Signal Level
1	RS422_TX2-	OUT	±5V
2	NC		
3	RS422_TX2+	OUT	±5V
4	NC		
5	RS422_RX2+	IN	
6	NC		
7	RS422_RX2-	IN	
8	NC/+5V/+12V	PWR	+5V/+12V
9	GND	GND	

Note 1: COM2 RS-232/422/485 can be set by BIOS setting. Default is RS-232.

Note 2: Pin 8 function can be set by JP3 (See Ch 2.3.2).

2.4.9 Mini-Card Slot (Full-Mini Card) (CN10)

Pin	Pin Name	Signal Type	Signal level
1	PCIE_WAKE#	IN	
2	+3.3VSB	PWR	+3.3V
3	NC		
4	GND	GND	
5	NC		
6	+1.5V	PWR	+1.5V
7	PCIE_CLK_REQ#	IN	
8	UIM_PWR	PWR	
9	GND	GND	
10	UIM_DATA	I/O	
11	PCIE_REF_CLK-	DIFF	
12	UIM_CLK	IN	
13	PCIE_REF_CLK+	DIFF	
14	UIM_RST	IN	
15	GND	GND	
16	UIM_VPP	PWR	
17	NC		
18	GND	GND	
19	NC		
20	W_DISABLE#	OUT	+3.3V
21	GND	GND	
22	PCIE_RST#	OUT	+3.3V
23	PCIE_RX-	DIFF	
24	+3.3VSB	PWR	+3.3V

Pin	Pin Name	Signal Type	Signal level
25	PCIE_RX+	DIFF	
26	GND	GND	
27	GND	GND	
28	+1.5V	PWR	+1.5V
29	GND	GND	
30	SMB_CLK	I/O	+3.3V
31	PCIE_TX-	DIFF	
32	SMB_DATA	I/O	+3.3V
33	PCIE_TX+	DIFF	
34	GND	GND	
35	GND	GND	
36	USB_D-	DIFF	
37	GND	GND	
38	USB_D+	DIFF	
39	+3.3VSB	PWR	+3.3V
40	GND	GND	
41	+3.3VSB	PWR	+3.3V
42	NC		
43	GND	GND	
44	NC		
45	NC		
46	NC		
47	NC		
48	+1.5V	PWR	+1.5V
49	NC		
50	GND	GND	

Pin	Pin Name	Signal Type	Signal level
51	NC		
52	+3.3VSB	PWR	+3.3V

2.4.10 DDR SO-DIMM Slot (CN11)

Standard Specifications

2.4.11 M.2 E-Key 2230 (CN12)

Standard Specifications

2.4.12 LVDS Port Inverter /Backlight Connector (CN3)

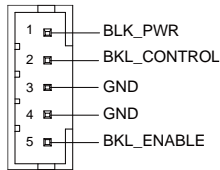

Pin	Pin Name	Signal Type	Signal level
1	BKL_PWR	PWR	+5V / +12V
2	BKL_CONTROL	OUT	
3	GND	GND	
4	GND	GND	
5	BKL_ENABLE	OUT	+5V

Note 1: LVDS BKL_PWR can be set to +5V or +12V by JP4. (See Ch 2.3.3)

Note 2: LVDS BKL_CONTROL can be set by JP5. (See Ch 2.3.4)

2.4.13 LVDS Port (CN14)

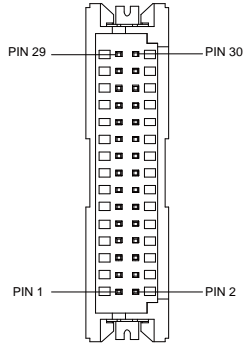

Note: LVDS LCD_PWR can be set to +3.3V or +5V by JP4. (See Ch 2.3.3)

Pin	Pin Name	Signal Type	Signal Level
1	BKL_ENABLE	OUT	
2	BKL_CONTROL	OUT	
3	LCD_PWR	PWR	+3.3V/+5V
4	GND	GND	
5	LVDS_A_CLK-	DIFF	
6	LVDS_A_CLK+	DIFF	
7	LCD_PWR	PWR	+3.3V/+5V
8	GND	GND	
9	LVDS_DA0-	DIFF	
10	LVDS_DA0+	DIFF	
11	LVDS_DA1-	DIFF	
12	LVDS_DA1+	DIFF	
13	LVDS_DA2-	DIFF	
14	LVDS_DA2+	DIFF	
15	LVDS_DA3-	DIFF	

Pin	Pin Name	Signal Type	Signal Level
16	LVDS_DA3+	DIFF	
17	DDC_DATA	I/O	+3.3V
18	DDC_CLK	I/O	+3.3V
19	LVDS_DB0-	DIFF	
20	LVDS_DB0+	DIFF	
21	LVDS_DB1-	DIFF	
22	LVDS_DB1+	DIFF	
23	LVDS_DB2-	DIFF	
24	LVDS_DB2+	DIFF	
25	LVDS_DB3-	DIFF	
26	LVDS_DB3+	DIFF	
27	LCD_PWR	PWR	+3.3V/+5V
28	GND	GND	
29	LVDS_B_CLK-	DIFF	
30	LVDS_B_CLK+	DIFF	

2.4.14 USB 2.0 Port 5 (CN15)

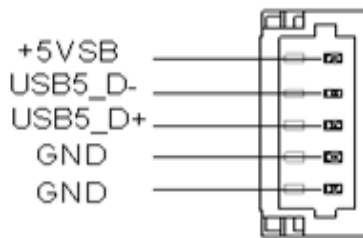

Pin	Pin Name	Signal Type	Signal Level
1	+5VSB	PWR	+5V
2	USB5_D-	DIFF	

Pin	Pin Name	Signal Type	Signal Level
3	USB5_D+	DIFF	
4	GND	GND	
5	GND	GND	

2.4.15 BIOS Debug Port (CN16)

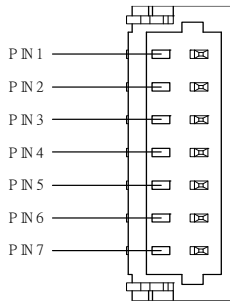

Pin	Pin Name	Signal Type	Signal Level
1	SPI_MISO	OUT	
2	GND	GND	
3	SPI_CLK	IN	
4	+3.3VSB	PWR	+3.3V
5	SPI_MOSI	IN	
6	SPI_CS	IN	
7	NC		

2.4.16 USB 2.0 Port 6 (CN17)

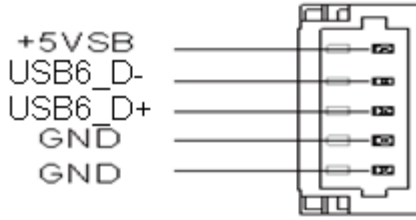

Pin	Pin Name	Signal Type	Signal Level
1	+5VSB	PWR	+5V
2	USB6_D-	DIFF	
3	USB6_D+	DIFF	
4	GND	GND	
5	GND	GND	

2.4.17 LPC Port (CN18)

Pin	Pin Name	Signal Type	Signal Level
1	LAD0	I/O	+3.3V
2	LAD1	I/O	+3.3V
3	LAD2	I/O	+3.3V
4	LAD3	I/O	+3.3V
5	+3.3V	PWR	+3.3V
6	LFRAME#	IN	
7	LRESET#	OUT	+3.3V
8	GND	GND	
9	LCLK	OUT	
10	SMB_DATA/I2C_SDA	I/O	

Pin	Pin Name	Signal Type	Signal Level
11	SMB_CLK/I2C_CLK	OUT	
12	SMB_ALERT/SERIRQ	IN	+3.3V

2.4.18 Digital I/O Port (CN19)

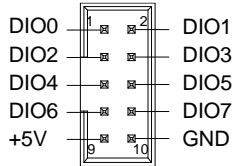

Pin	Signal Description	Pin	Signal Description
1	PD0	2	PD1
3	PD2	4	PD3
5	PD4	6	PD5
7	PD6	8	PD7
9	+V5S	10	GND

2.4.19 Nano SIM Card Socket (CN20)

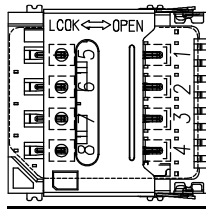

Pin	Pin Name	Signal Type	Signal Level
1	UIM_PWR	PWR	
2	UIM_RST	IN	
3	UIM_CLK	IN	

Pin	Pin Name	Signal Type	Signal Level
4	NC		
5	GND	GND	
6	UIM_VPP	PWR	
7	UIM_DATA	I/O	
8	NC		

2.4.20 Touchscreen Connector (Optional) (CN21)

Note: Touch mode can be set by BIOS.

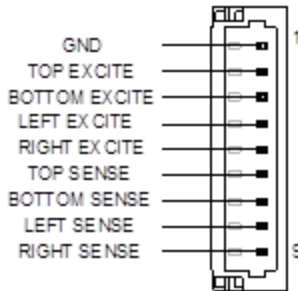

8-Wire			
Pin	Pin Name	Signal Type	Signal Level
1	GND	GND	
2	TOP EXCITE	IN	
3	BOTTOM EXCITE	IN	
4	LEFT EXCITE	IN	
5	RIGHT EXCITE	IN	
6	TOP SENSE	IN	
7	BOTTOM SENSE	IN	
8	LEFT SENSE	IN	
9	RIGHT SENSE	IN	

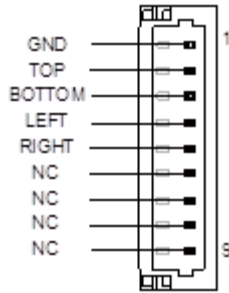

4-Wire

Pin	Pin Name	Signal Type	Signal Level
1	GND	GND	
2	TOP	IN	
3	BOTTOM	IN	
4	LEFT	IN	
5	RIGHT	IN	
6	NC		
7	NC		
8	NC		
9	NC		

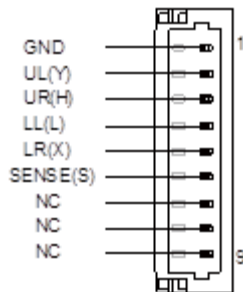

5-Wire

Pin	Pin Name	Signal Type	Signal Level
1	GND	GND	

5-Wire			
Pin	Pin Name	Signal Type	Signal Level
2	UL(Y)	IN	
3	UR(H)	IN	
4	LL(L)	IN	
5	LR(X)	IN	
6	SENSE(S)	IN	
7	NC		
8	NC		
9	NC		

2.4.21 CPU Fan (CN22)

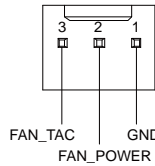

Pin	Pin Name	Signal Type	Signal Level
1	GND	GND	
2	FAN_POWER	PWR	+12V
3	FAN_TAC	IN	

2.4.22 Battery Connector (CN23)

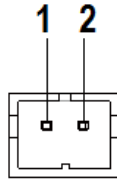

Pin	Pin Name	Signal Type	Signal level
1	+3.3V	PWR	3.3V
2	GND	GND	

2.4.23 LAN (RJ-45) Port 1/Port 2 (CN24/CN25)

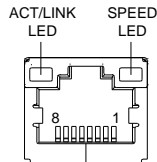

Pin	Pin Name	Signal Type	Signal level
1	MDI0+	DIFF	
2	MDI0-	DIFF	
3	MDI1+	DIFF	
4	MDI2+	DIFF	
5	MDI2-	DIFF	
6	MDI1-	DIFF	
7	MDI3+	DIFF	
8	MDI3-	DIFF	

2.4.24 USB 3.2 Gen 2 Ports 0 & 1 (CN26)

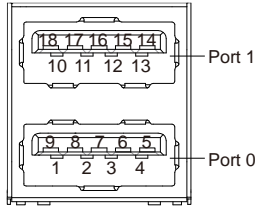

Pin	Pin Name	Signal Type	Signal Level
1	+5VSB	PWR	+5V
2	USB0_D-	DIFF	
3	USB0_D+	DIFF	
4	GND	GND	
5	USB0_SSRX-	DIFF	
6	USB0_SSRX+	DIFF	
7	GND	GND	
8	USB0_SSTX-	DIFF	
9	USB0_SSTX+	DIFF	
10	+5VSB	PWR	+5V
11	USB1_D-	DIFF	
12	USB1_D+	DIFF	
13	GND	GND	
14	USB1_SSRX-	DIFF	
15	USB1_SSRX+	DIFF	
16	GND	GND	
17	USB1_SSTX-	DIFF	
18	USB1_SSTX+	DIFF	

2.4.25 USB 3.2 Gen 2 Ports 2 & 3 (CN27)

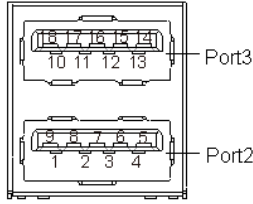

Pin	Pin Name	Signal Type	Signal Level
1	+5VSB	PWR	+5V
2	USB2_D-	DIFF	
3	USB2_D+	DIFF	
4	GND	GND	
5	USB2_SSRX-	DIFF	
6	USB2_SSRX+	DIFF	
7	GND	GND	
8	USB2_SSTX-	DIFF	
9	USB2_SSTX+	DIFF	
10	+5VSB	PWR	+5V
11	USB3_D-	DIFF	
12	USB3_D+	DIFF	
13	GND	GND	
14	USB3_SSRX-	DIFF	
15	USB3_SSRX+	DIFF	
16	GND	GND	
17	USB3_SSTX-	DIFF	
18	USB3_SSTX+	DIFF	

2.4.26 HDMI (CN28)

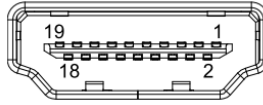

Pin	Pin Name	Signal Type	Signal Level
1	HDMI_TX2+	DIFF	
2	GND	GND	
3	HDMI_TX2-	DIFF	
4	HDMI_TX1+	DIFF	
5	GND	GND	
6	HDMI_TX1-	DIFF	
7	HDMI_TX0+	DIFF	
8	GND	GND	
9	HDMI_TX0-	DIFF	
10	HDMI_CLK+	DIFF	
11	GND	GND	
12	HDMI_CLK-	DIFF	
13	NC		
14	NC		
15	DDC_CLK	I/O	+5V
16	DDC_DATA	I/O	+5V
17	GND	GND	
18	+5V	PWR	+5V
19	HDMI_HPD		

2.4.27 VGA Port (CN29)

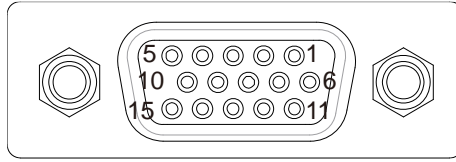

Pin	Pin Name	Signal Type	Signal Level
1	RED	OUT	
2	GREEN	OUT	
3	BLUE	OUT	
4	NC		
5	GND	GND	
6	RED_GND_RTN	GND	
7	GREEN_GND_RTN	GND	
8	BLUE_GND_RTN	GND	
9	+5V	PWR	+5V
10	NC		
11	NC		
12	DDC_DATA	I/O	+5V
13	HSYNC	OUT	
14	VSYNC	OUT	
15	DDC_CLK	I/O	+5V

2.4.28 M.2 B-Key 2280 (CN30)

Standard Specifications

2.4.29 LAN SPD Connector (CN31)

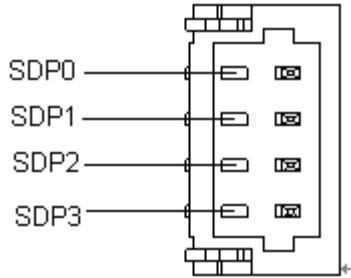

Pin	Pin Name	Signal Type	Signal Level
1	SDP0	I/O	
2	SDP1	I/O	
3	SDP2	I/O	
4	SDP3	I/O	

2.5 Assembly Options

Option 1

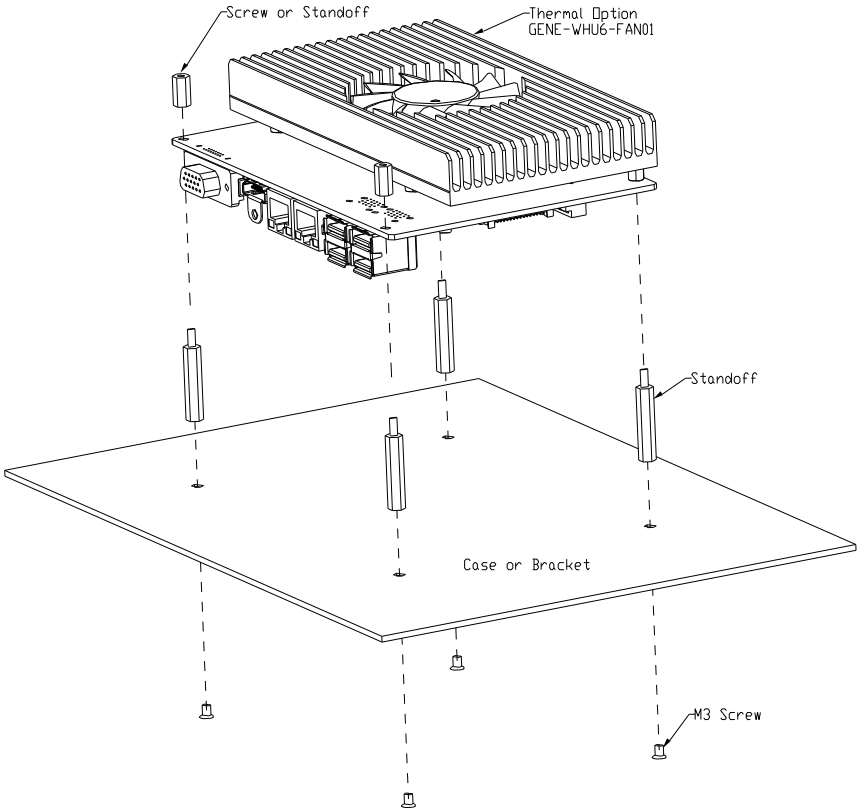

Option 2

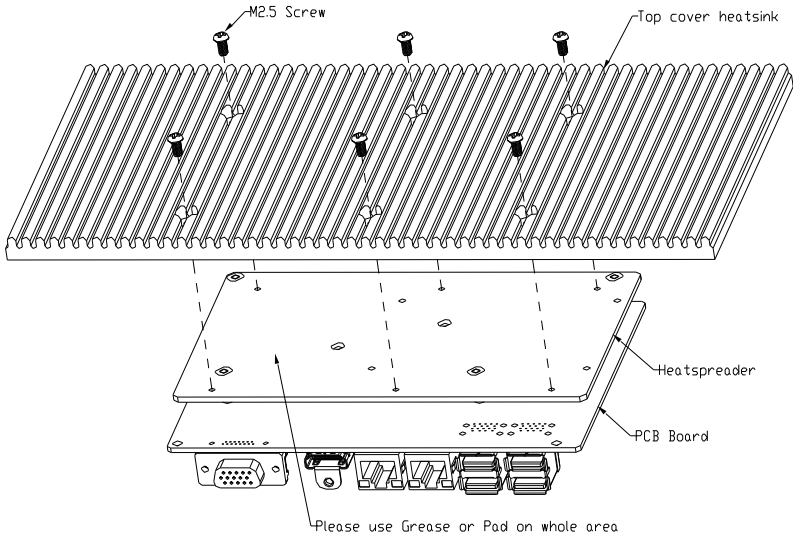

2.6 Block Diagram

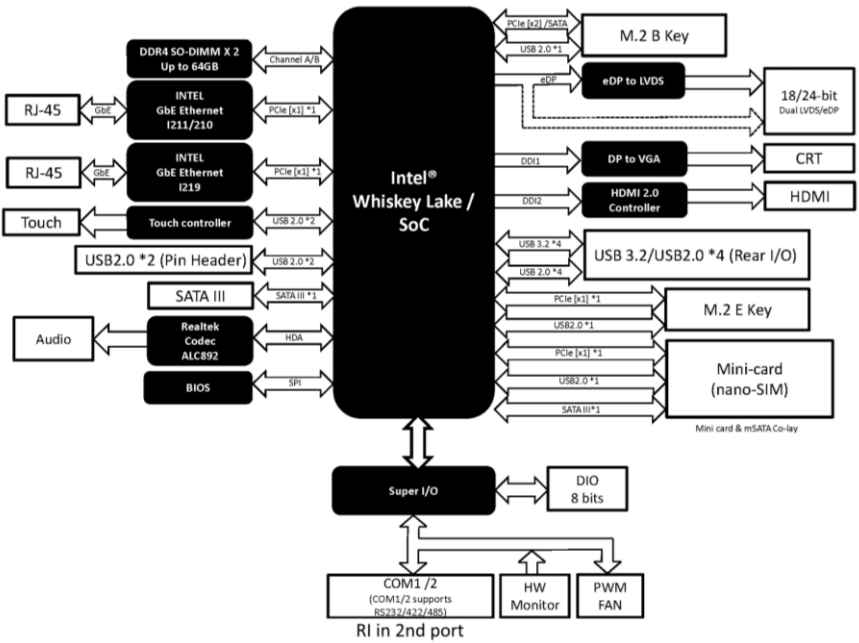

Chapter 3

AMI BIOS Setup

3.1 System Test and Initialization

The GENE-WHU6 board uses certain routines to perform testing and initialization during the boot up sequence. If an error, fatal or non-fatal, is encountered, the module will output a few short beeps or display an error message. The module can usually continue the boot up sequence with non-fatal errors.

The system configuration verification routines check the current system configuration against the values stored in the CMOS memory and BIOS NVRAM. If a system configuration is not found or an error is detected, the module will load the default configuration and reboot automatically.

There are four situations in which you will need to setup system configuration:

1. You are starting your system for the first time
2. You have changed the hardware attached to your system
3. The system configuration was reset by the Clear-CMOS jumper
4. The CMOS memory has lost power and the configuration information has been erased.

The system CMOS memory has an integral lithium battery backup for data retention.

You will need to replace the battery unit when it runs down.

3.2 AMI BIOS Setup

The AMI BIOS ROM has a pre-installed Setup program that allows users to modify basic system configurations, which is stored in the battery-backed CMOS RAM and BIOS NVRAM so that the information is retained when the power is turned off.

To enter BIOS Setup, press or <ESC> immediately while your computer is powering up.

The function for each interface can be found below.

Main – Date and time can be set here. Press <Tab> to switch between date elements

Advanced – Enable/ Disable boot option for legacy network devices

Chipset – Host bridge parameters

Security – The setup administrator password can be set here

Boot – Enable/ Disable Quiet Boot option

Save & Exit – Save your changes and exit the program

3.3 Setup Submenu: Main

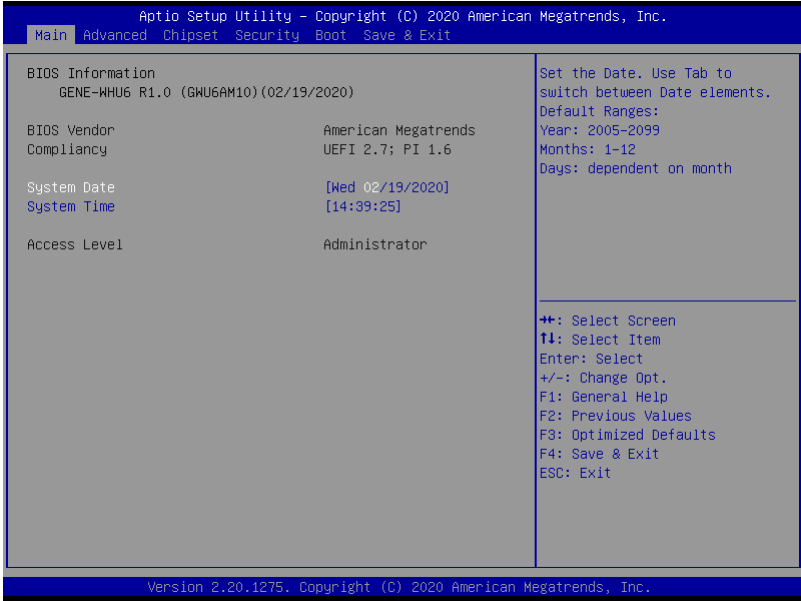

3.4 Setup Submenu: Advanced

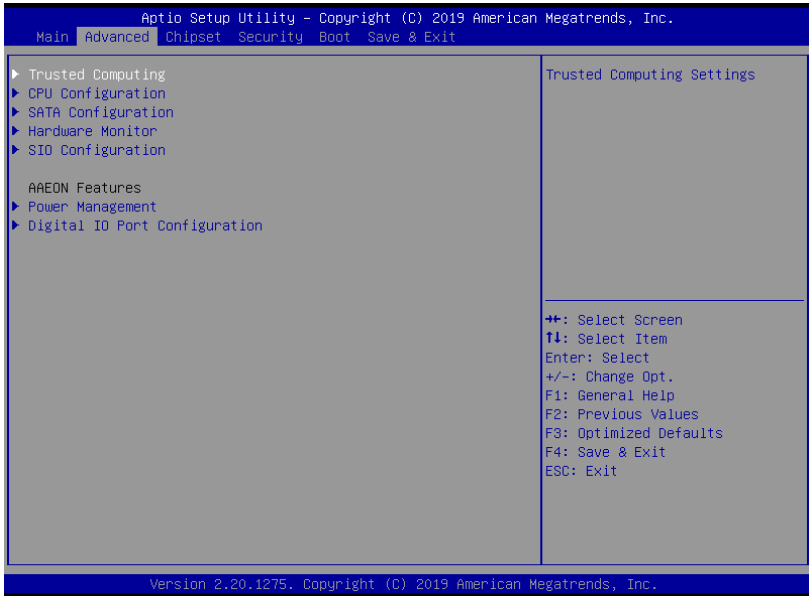

3.4.1 Advanced: Trusted Computing

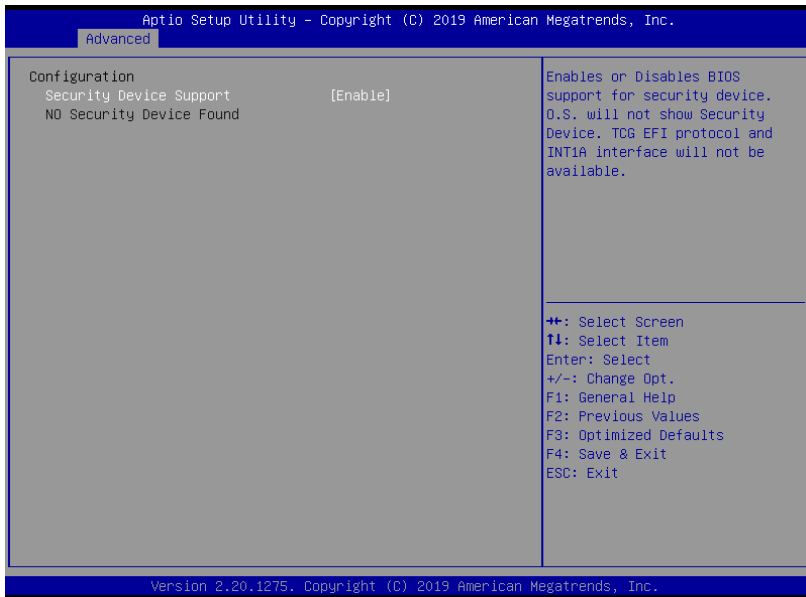

Options Summary		
Security Device Support	Disable	Optimal Default, Failsafe Default
	Enable	
Enables or Disables BIOS support for security device. O.S. will not show Security Device. TCG EFI protocol and INT1A interface will not be available.		
SHA-1 PCR Bank	Disable	Optimal Default, Failsafe Default
	Enable	
Enable or Disable SHA-1 PCR Bank		
SHA256 PCR Bank	Disable	Optimal Default, Failsafe Default
	Enable	
Enable or Disable SHA256 PCR Bank		
Pending Operation	None	Optimal Default, Failsafe Default
	TPM Clear	
Schedule an Operation for the Security Device. NOTE: Your Computer will reboot during restart in order to change State of Security Device.		

Table continues on next page...

Options Summary		
Platform Hierarchy	Disabled	Optimal Default, Failsafe Default
	Enabled	
Enable or disable Platform Hierarchy		
Storage Hierarchy	Disabled	Optimal Default, Failsafe Default
	Enabled	
Enable or Disable Storage Hierarchy		
Endorsement Hierarchy	Disabled	Optimal Default, Failsafe Default
	Enabled	
Enable or Disable Endorsement Hierarchy		
TPM2.0 UEFI Spec Version	TCG_1_2	Optimal Default, Failsafe Default
	TCG_2	
Select the TCG2 Spec Version Support, TCG_1_2: Compatible mode for Win8/Win10 TCG_2: Support new TCG2 protocol and event format for Win10 or later		
Physical Presence Spec Version	1.2	Optimal Default, Failsafe Default
	1.3	
Select to Tell O.S. to support PPI Spec Version 1.2 or 1.3. Note some HCK tests might not support 1.3.		

3.4.2 Advanced: CPU Configuration

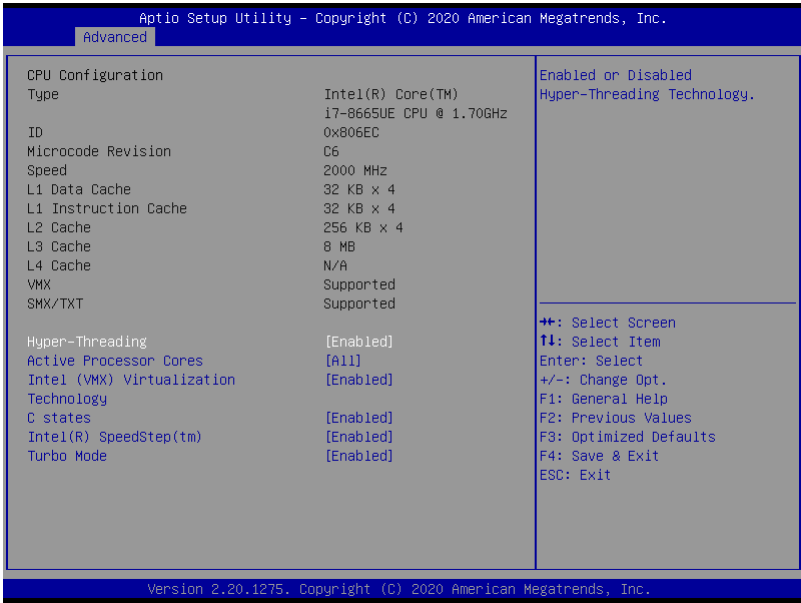

Options Summary		
Hyper-Threading	Disabled	Optimal Default, Failsafe Default
	Enabled	
Enable/Disable Hyper-Threading Technology		
Active Processor Cores	All	Optimal Default, Failsafe Default
	*	
Number of cores to enable in each processor package.		
Intel (VMX) Virtualization Technology	Disabled	Optimal Default, Failsafe Default
	Enabled	
When enabled, a VMM can utilize the additional hardware capabilities provided by Vanderpool Technology.		
C-States	Disabled	Optimal Default, Failsafe Default
	Enabled	
Enable/Disable C States.		
Intel(R) SpeedStep(tm)	Disabled	Optimal Default, Failsafe Default
	Enabled	
Allows more than two frequency ranges to be supported.		

Table continues on next page...

Options Summary

Turbo Mode	Disabled	Optimal Default, Failsafe Default
	Enabled	
Enable/Disable Turbo mode		

3.4.3 Advanced: SATA Configuration

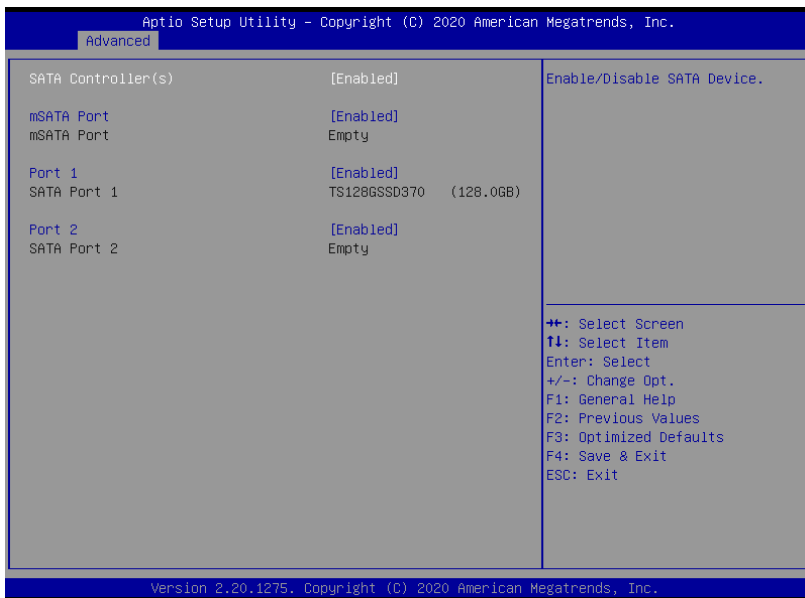

Options Summary

SATA Controller(s)	Disabled	Optimal Default, Failsafe Default
	Enabled	
Enable/Disable SATA Device.		
mSATA port	Disabled	Optimal Default, Failsafe Default
	Enabled	
Enable or Disable SATA Port		
Port *	Disabled	Optimal Default, Failsafe Default
	Enabled	
Enable or Disable SATA Port		

3.4.4 Advanced: Hardware Monitor

The screenshot shows the 'Advanced' section of the Aptio Setup Utility. The title bar reads 'Aptio Setup Utility - Copyright (C) 2020 American Megatrends, Inc.' and the sub-header is 'Advanced'. The main area is divided into two columns. The left column, titled 'Pc Health Status', lists various system metrics: THERMAL_SRC1(T1) at +34%, THERMAL_SRC1(T2) at +32%, CPU(DTS) Temperature at +38%, CPU Fan Speed at 2868 RPM, VCORE at +0.776 V, +12V at +12.144 V, +5V at +5.045 V, VMEM at +1.208 V, +3.3V at +3.344 V, +5VSB at +5.040 V, and VBAT at +2.608 V. Below these are 'Smart Fan' [Enabled] and 'Smart Fan Mode Configuration'. The right column is titled 'Enable or Disable Smart Fan' and contains a list of navigation instructions: '+': Select Screen, '↑': Select Item, Enter: Select, '+/-': Change Opt., F1: General Help, F2: Previous Values, F3: Optimized Defaults, F4: Save & Exit, and ESC: Exit. A footer at the bottom of the screen reads 'Version 2.20.1275. Copyright (C) 2020 American Megatrends, Inc.'

Pc Health Status		Enable or Disable Smart Fan
THERMAL_SRC1(T1)	: +34 %	+/: Select Screen ↑: Select Item Enter: Select +/-: Change Opt. F1: General Help F2: Previous Values F3: Optimized Defaults F4: Save & Exit ESC: Exit
THERMAL_SRC1(T2)	: +32 %	
CPU(DTS) Temperature	: +38 %	
CPU Fan Speed	: 2868 RPM	
VCORE	: +0.776 V	
+12V	: +12.144 V	
+5V	: +5.045 V	
VMEM	: +1.208 V	
+3.3V	: +3.344 V	
+5VSB	: +5.040 V	
VBAT	: +2.608 V	
Smart Fan	[Enabled]	
▶ Smart Fan Mode Configuration		

3.4.4.1 Smart Fan Mode Configuration

Auto Duty Cycle Mode

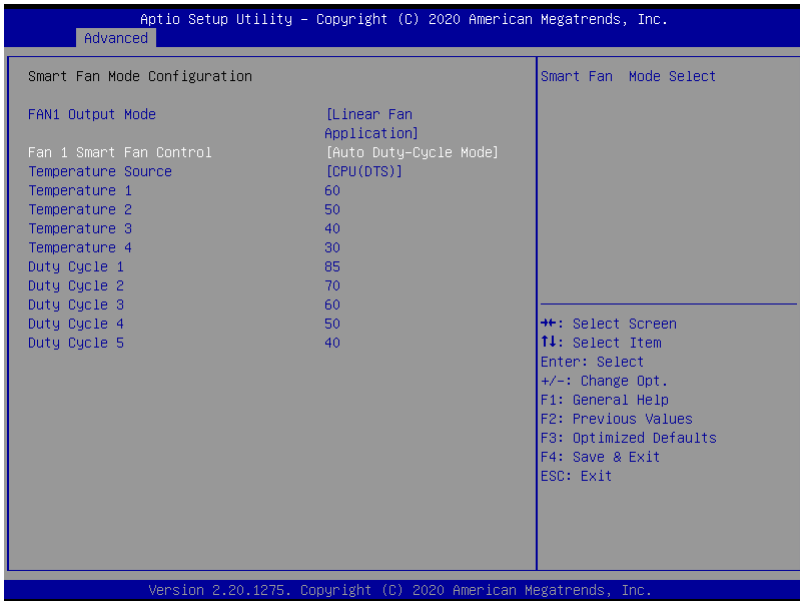

Options Summary		
FAN1 Output mode	Output PWM mode (open drain)	Optimal Default, Failsafe Default
	Linear Fan Application	
	Output PWM mode (push pull)	
FAN1 Output mode Select		
Fan Mode	Manual RPM Mode	Optimal Default, Failsafe Default
	Manual Duty-Cycle Mode	
	Auto RPM Mode	
	Auto Duty-Cycle Mode	
Smart Fan Mode Select		
Temperature Source	CPU(DTS)	Optimal Default, Failsafe Default
	THERMAL_SRC1(T1)	
	THERMAL_SRC1(T2)	
Select the monitored temperature source for this fan.		
Duty Cycle	Auto fan speed control. Fan speed will follow different temperature by different duty cycle 1-100	
Temperature		

Auto RPM Mode

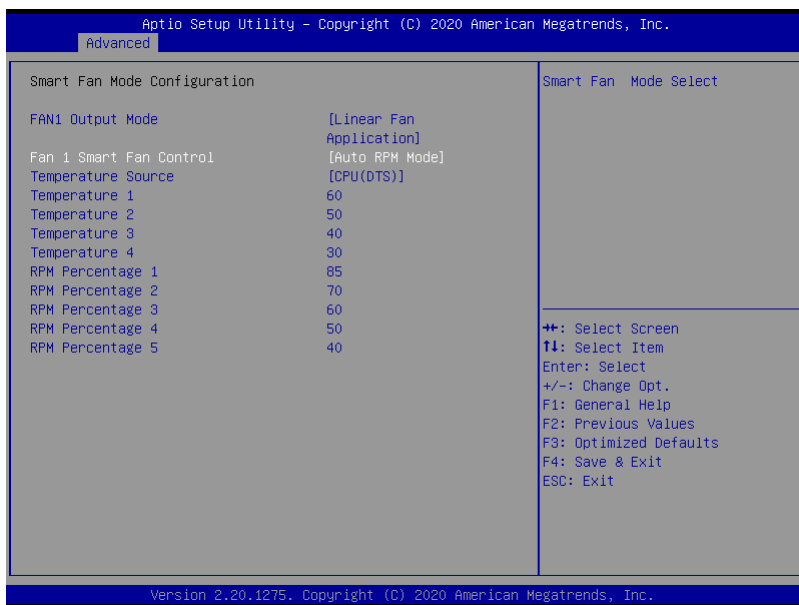

Options Summary

RPM Percentage	Auto fan speed control. Fan speed will follow different temperature by different RPM 1-100
Temperature	

Manual Duty Mode



Options Summary

Manual Duty Mode	60	Optimal Default, Failsafe Default
Manual mode fan control, user can write expected duty cycle (PWM fan type) 1-100		

Linear Fan Application

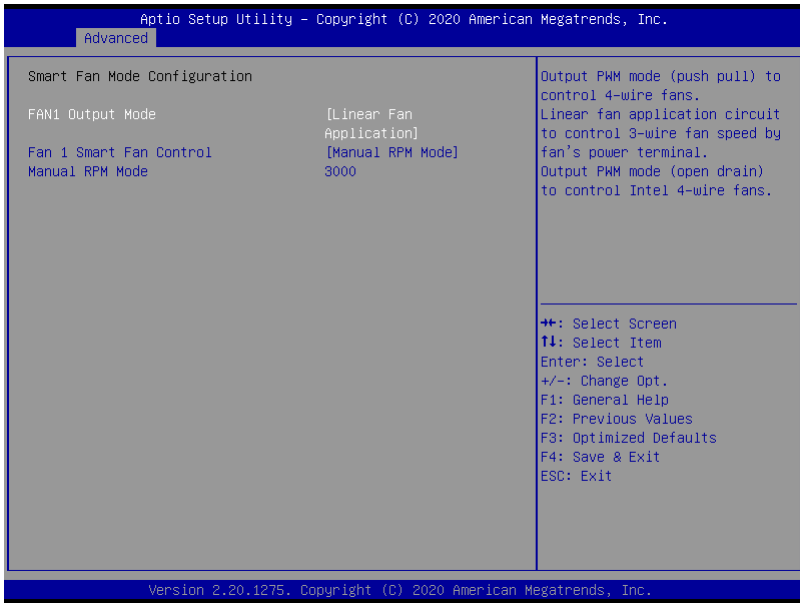

Options Summary

Auto RPM Mode	3000	Optimal Default, Failsafe Default
Manual mode fan control, user can write expected RPM count 500-10000		

3.4.5 Advanced: SIO Configuration

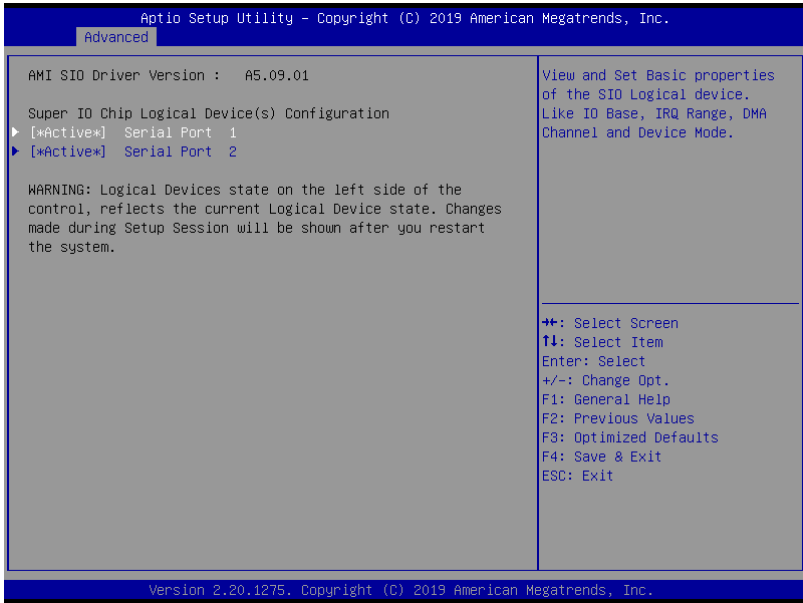

3.4.5.1 Serial Port 1 Configuration

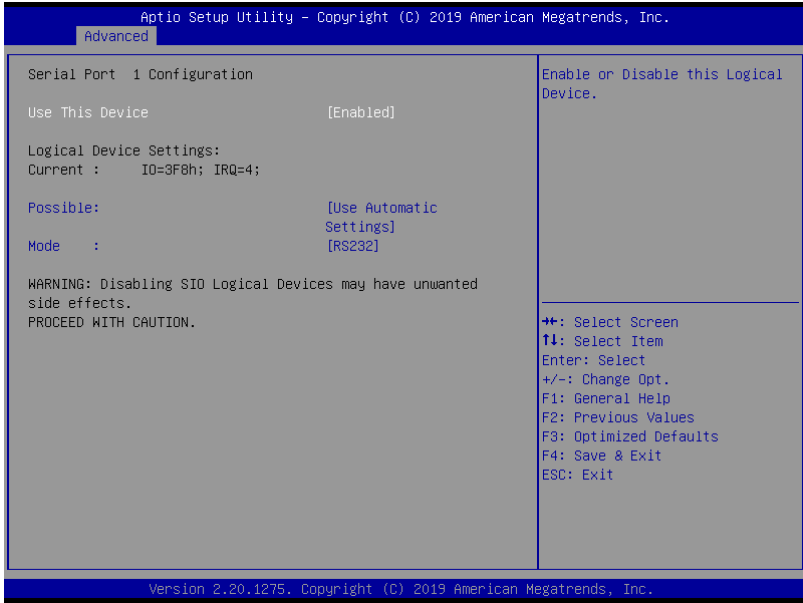

Options Summary

Use This Device	Disable	Optimal Default, Failsafe Default
	Enable	
Enable or Disable this Logical Device.		
Possible:	Use Automatic Settings	Optimal Default, Failsafe Default
	IO=3F8h; IRQ=4	
	IO=2F8h; IRQ=3	
Allows user to change Device's Resource settings. New settings will be reflected on This Setup Page after System restarts.		
Mode	RS232	Optimal Default, Failsafe Default
	RS422	
	RS485	
UART RS232, 422, 485 selection		

3.4.5.2 Serial Port 2 Configuration

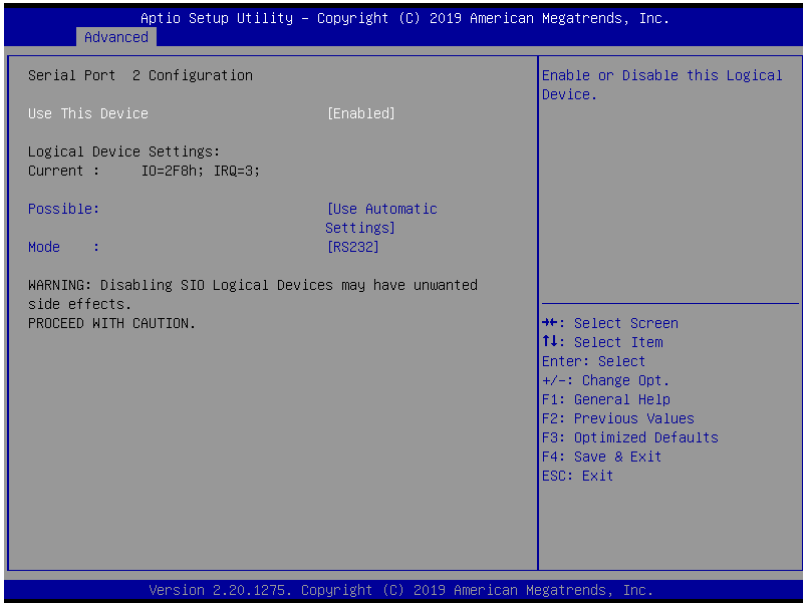

Options Summary		
Use This Device	Disable	Optimal Default, Failsafe Default
	Enable	
Enable or Disable this Logical Device.		
Possible:	Use Automatic Settings	Optimal Default, Failsafe Default
	IO=2F8h; IRQ=3	
	IO=3F8h; IRQ=4	
Allows user to change Device's Resource settings. New settings will be reflected on This Setup Page after System restarts.		
Mode	RS232	Optimal Default, Failsafe Default
	RS422	
	RS485	
UART RS232, 422, 485 selection		

3.4.6 Advanced: Power Management

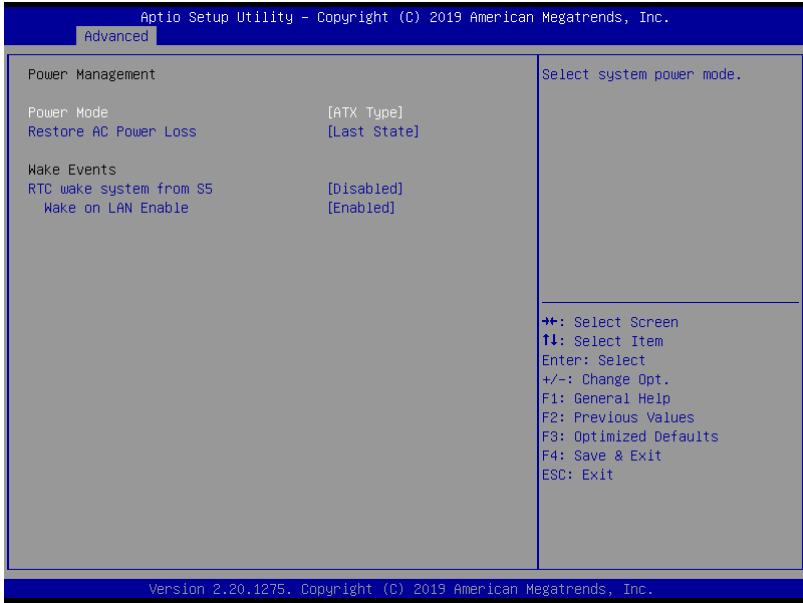

Options Summary		
Power Mode	ATX Type	Optimal Default, Failsafe Default
	AT Type	
Select system power mode		
Restore AC Power Loss	Last State	Optimal Default, Failsafe Default
	Always On	
	Always Off	
IO Restore AC power Loss		
RTC wake system from S5	Disable	Optimal Default, Failsafe Default
	Fixed Time	
	Dynamic Time	
Fixed Time: System will wake on the hr::min::sec specified./n Dynamic Time: System will wake on the current time + Increase minute(s)		
Wake on LAN Enable	Enabled	Optimal Default, Failsafe Default
	Disabled	
Enable/Disable integrated LAN to wake the system.		

3.4.7 Advanced: Digital IO Port Configuration

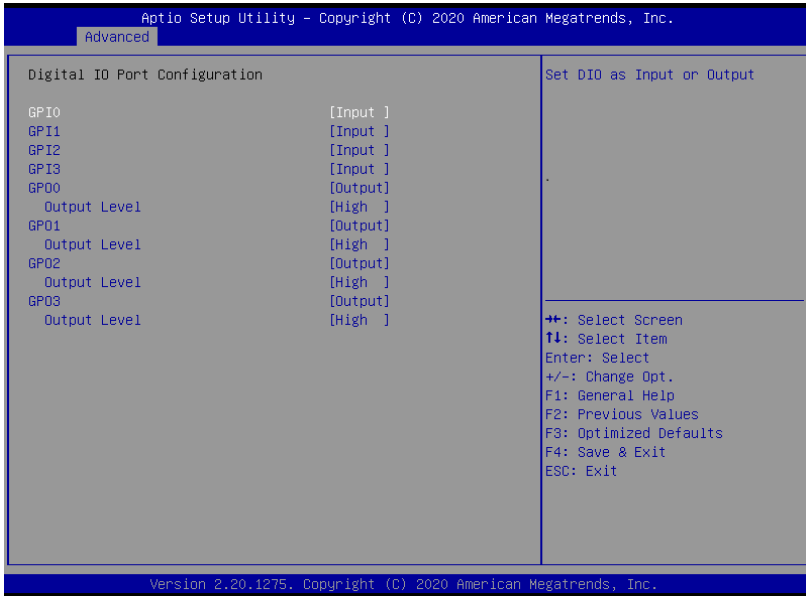

Options Summary		
DIO Port*	Output	
	Input	
Set DIO as Input or Output		
Output Level	High	Optimal Default, Failsafe Default
	Low	
Set output level when DIO pin is output		

3.5 Setup submenu: Chipset

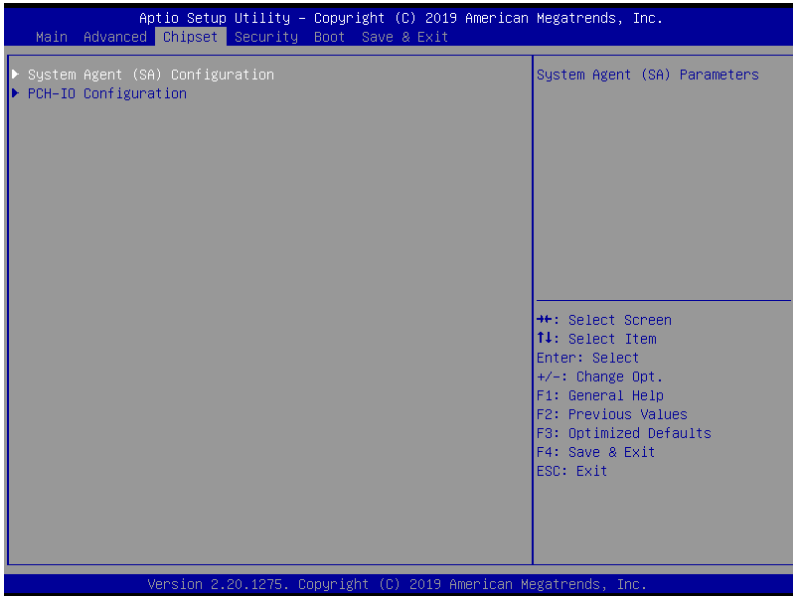

3.5.1 Chipset: System Agent (SA) Configuration

Aprio Setup Utility - Copyright (C) 2020 American Megatrends, Inc.

Chipset

Memory Configuration		Configure LVDS panel parameters.
Memory Frequency	2133 MHz	
Channel 0 Slot 0	Populated & Enabled	
Size	16384 MB (DDR4)	
Number of Ranks	2	
Manufacturer	Micron	
Channel 1 Slot 0	Not Populated / Disabled	
▶ LVDS Panel Configuration		

++: Select Screen
↑↓: Select Item
Enter: Select
+/-: Change Opt.
F1: General Help
F2: Previous Values
F3: Optimized Defaults
F4: Save & Exit
ESC: Exit

Version 2.20.1275. Copyright (C) 2020 American Megatrends, Inc.

3.5.1.1 LVDS Panel Configuration

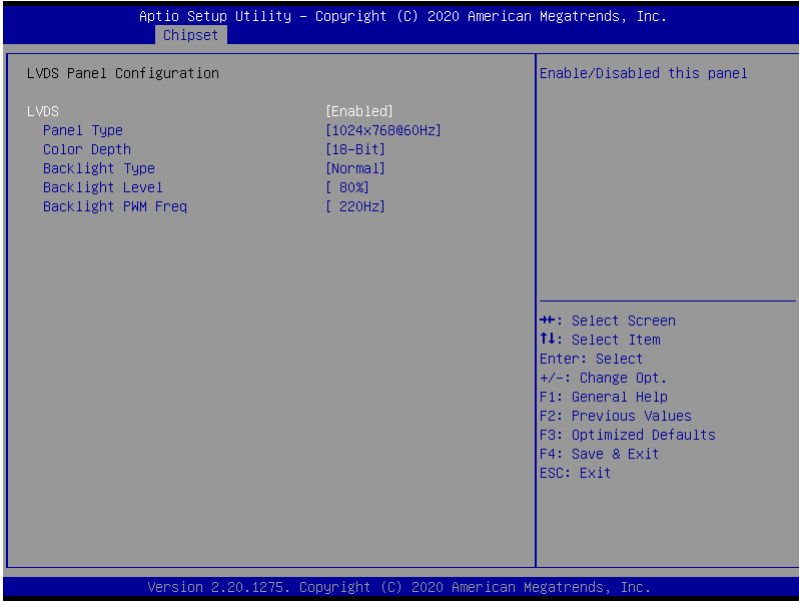

Options Summary

LVDS	Disabled	Optimal Default, Failsafe Default
	Enabled	
Enable/Disable this panel.		
LVDS Panel Type	640X480@60HZ	Optimal Default, Failsafe Default
	800X480@60HZ	
	800X600@60HZ	
	1024X600@60HZ	
	1024X768@60HZ	
	1280X768@60HZ	
	1280X800@60HZ	
	1280X1024@60HZ	
	1366X768@60HZ	
	1440X900@60HZ	
	1600X1200@60HZ	
	1920X1080@60HZ	
	1920X1200@60HZ	

Select LCD panel used by Internal Graphics Device by selecting the appropriate setup item.

Options Summary		
Color Depth	18-bit	Optimal Default, Failsafe Default
	24-bit	
	36-bit	
	48-bit	
Select panel type		
Backlight Type	Normal	Optimal Default, Failsafe Default
	Inverted	
Select backlight control signal type		
Backlight Level	0%	Optimal Default, Failsafe Default
	10%	
	20%	
	30%	
	40%	
	50%	
	60%	
	70%	
	80%	
	100%	
Select backlight control level		
Backlight PWM Freq	100Hz	Optimal Default, Failsafe Default
	200Hz	
	220Hz	
	500Hz	
	1.1KHz	
	2.2KHz	
	6.5KHz	
Select PWM frequency of backlight control signal		

3.5.2 Chipset: PCH IO Configuration

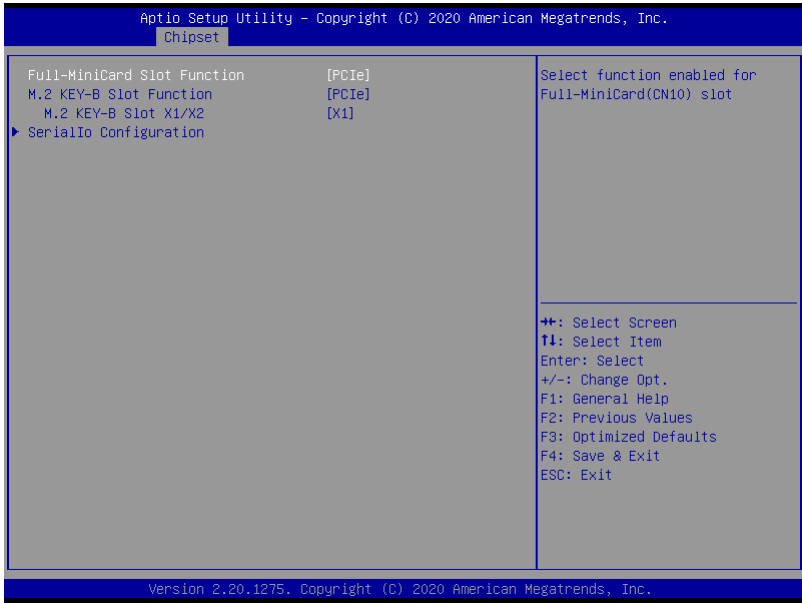

Options Summary		
Full-MiniCard Slot Function	SATA	Optimal Default, Failsafe Default
	PCIe	
Select function enabled for Full-Size MiniCard Slot		
M.2 KEY-B Slot Function	SATA	Optimal Default, Failsafe Default
	PCIe	
Select function enabled for M.2 KEY-B		
M.2 KEY-B Slot X1/X2	X1	Optimal Default, Failsafe Default
	X2	
Select X1/X2 for M.2 KEY-B Slot		

3.5.2.1 Serial IO Configuration

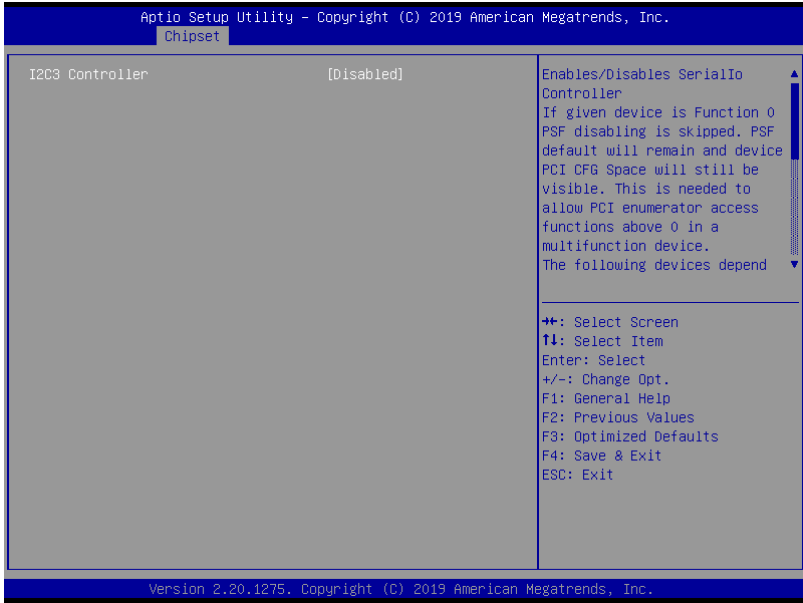

Options Summary

I2C3 Controller	Disabled	
	Enabled	Optimal Default, Failsafe Default
Enables/Disables Serial IO Controller		

3.6 Setup submenu: Security

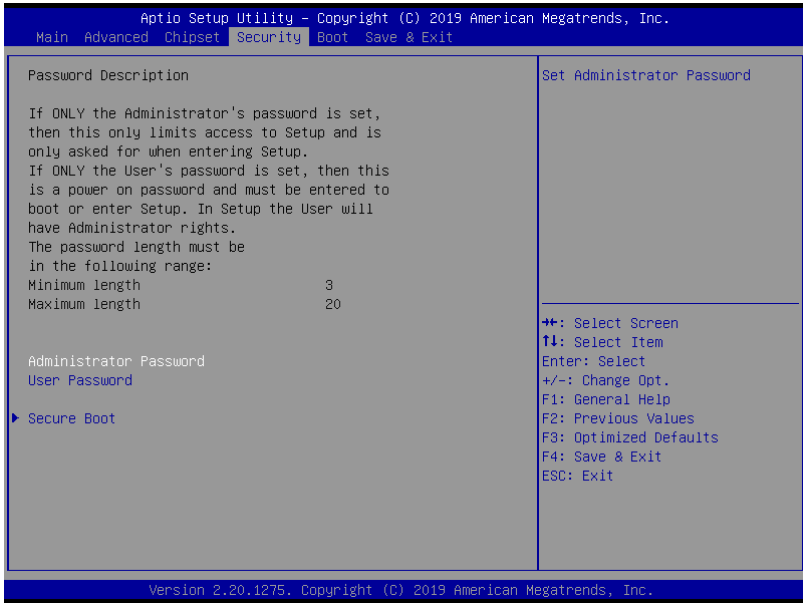

Change User/Administrator Password

You can set an Administrator Password or User Password. An Administrator Password must be set before you can set a User Password. The password will be required during boot up, or when the user enters the Setup utility. A User Password does not provide access to many of the features in the Setup utility.

Select the password you wish to set, and press Enter. In the dialog box, enter your password (must be between 3 and 20 letters or numbers). Press Enter and retype your password to confirm. Press Enter again to set the password.

Removing the Password

Select the password you want to remove and enter the current password. At the next dialog box press Enter to disable password protection.

3.6.1 Security: Secure Boot

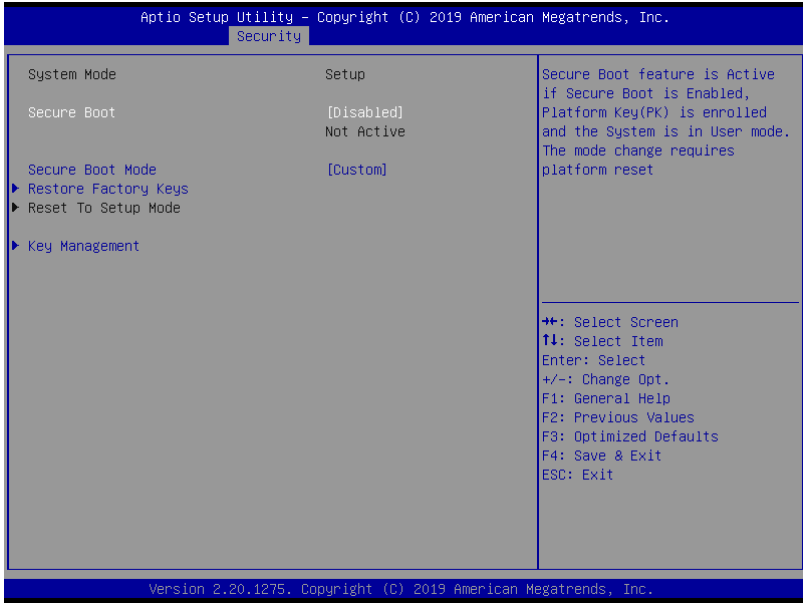

Options Summary

Secure Boot	Disabled	Optimal Default, Failsafe Default
	Enabled	
Secure Boot feature is Active if Secure Boot is Enabled, Platform Key(PK) is enrolled and the System is in User mode. The mode change requires platform reset		
Secure Boot Mode	Custom	Optimal Default, Failsafe Default
	Standard	
Secure Boot mode options: Standard or Custom. In Custom mode, Secure Boot Policy variables can be configured by a physically present user without full authentication		
Restore Factory Keys		
Force System to User Mode. Install factory default Secure Boot key databases		
Reset To Setup Mode		
Delete all Secure Boot key databases from NVRAM		

3.6.1.1 Key Management

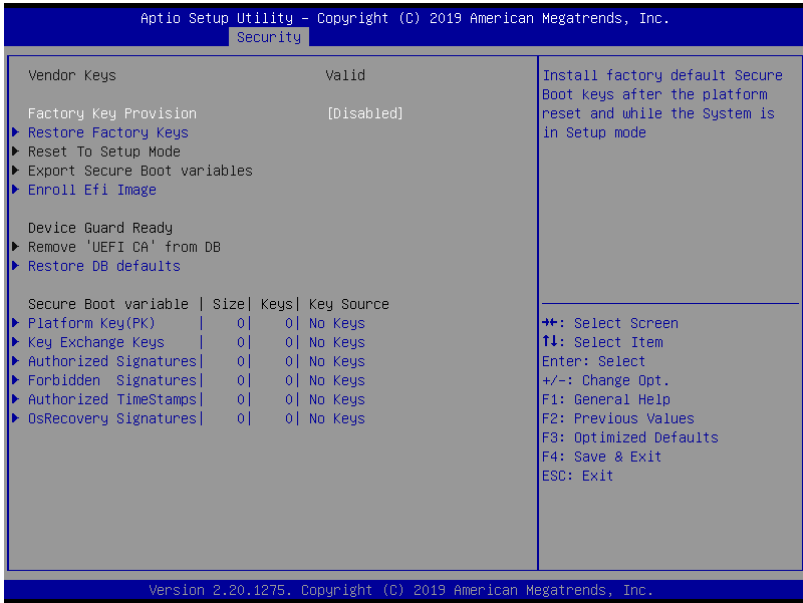

Options Summary		
Factory Key Provision	Disabled	Optimal Default, Failsafe Default
	Enabled	
Secure Boot feature is Active if Secure Boot is Enabled, Platform Key(PK) is enrolled and the System is in User mode. The mode change requires platform reset		
Restore Factory Keys		
Force System to User Mode. Install factory default Secure Boot key databases		
Reset To Setup Mode		
Delete all Secure Boot key databases from NVRAM		
Export Secure Boot variables		
Copy NVRAM content of Secure Boot variables to files in a root folder on a file system device		
Enroll Efi Image		
Allow the image to run in Secure Boot mode. Enroll SHA256 Hash certificate of a PE image into Authorized Signature Database (db)		
Remove 'UEFI CA' from DB		
Device Guard ready system must not list 'Microsoft UEFI CA' Certificate in Authorized Signature database (db)		

Options Summary		
Restore DB defaults		
Restore DB variable to factory defaults		
Platform Key(PK)	Details	
	Export	
	Update	
	Delete	
Key Exchange Keys	Details	
	Export	
	Update	
	Append	
	Delete	
Authorized Signatures	Details	
	Export	
	Update	
	Append	
	Delete	
Forbidden Signatures	Details	
	Export	
	Update	
	Append	
	Delete	
Authorized TimeStamps	Update	
	Append	
OsRecovery Signatures	Update	
	Append	
Enroll Factory Defaults or load certificates from a file: <ol style="list-style-type: none"> Public Key Certificate: <ol style="list-style-type: none"> EFI_SIGNATURE_LIST EFI_CERT_X509 (DER) EFI_CERT_RSA2048 (bin) EFI_CERT_SHAXXX Authenticated UEFI Variable EFI PE/COFF Image (SHA256) Key Source: Factory, External, Mixed		

3.7 Setup submenu: Boot

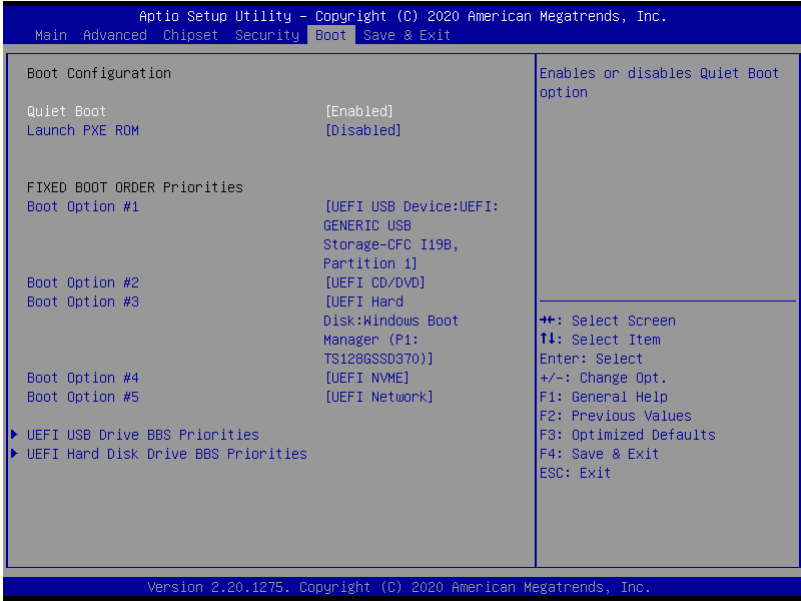

Options Summary		
Quiet Boot	Disabled	Optimal Default, Failsafe Default
	Enabled	
Enable/Disable showing boot logo.		
Lunch PXE ROM	Disabled	Optimal Default, Failsafe Default
	Enabled	
Controls the execution of UEFI and Legacy Network OpROM		

3.7.1 Boot: BBS Priorities

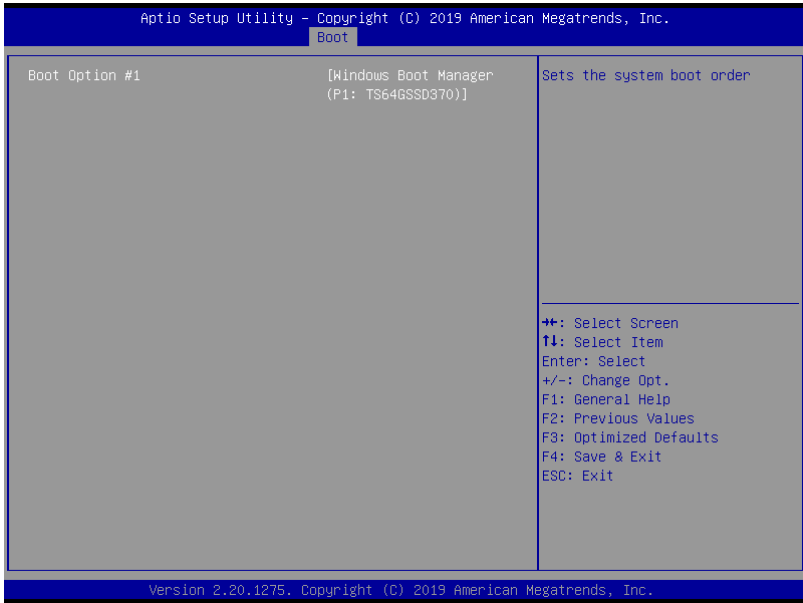

3.8 Setup submenu: Save & Exit

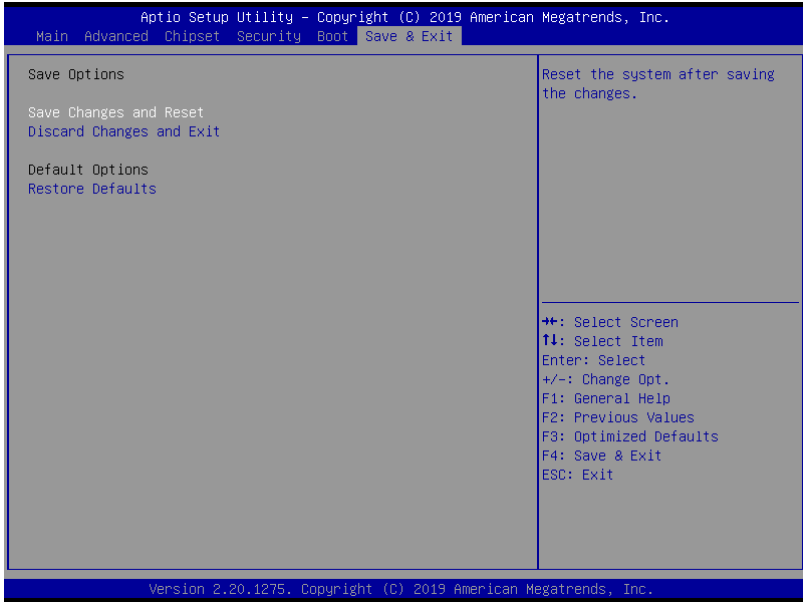

Chapter 4

Driver Installation

4.1 Driver Download/Installation

Drivers for the GENE-WHU6 can be downloaded from the product page on the AAEON website by following this link:

<https://www.aaeon.com/en/p/3and-half-inches-subcompact-boards-gene-bt06>

Download the driver(s) you need and follow the steps below to install them.

Step 1 – Install Chipset Drivers

1. Open the **Step 1 – Intel Chipset** folder then the **Win10** folder
2. Run the **SetupChipset.exe** in the folder
3. Follow the instructions
4. Drivers will be installed automatically

Step 2 – Install Graphics Drivers

1. Open the **Step 2 – Intel Graphics** folder and select your OS
2. Run the **igxpip.exe** file in the folder
3. Follow the instructions
4. Drivers will be installed automatically

Step 3 – Install ME Drivers

1. Click on the **Step 3 – Intel Management Engine** folder and select your OS
2. Run the **SetupME.exe** file in the folder
3. Follow the instructions
4. Drivers will be installed automatically

Step 4 – Install Serial IO Drivers

1. Open the **Step 4 – Intel Serial IO** folder and select your OS
2. Run the **SetupSerialIO.exe** file in the folder
3. Follow the instructions
4. Drivers will be installed automatically

Step 5 – Install LAN Driver

1. Open the **Step 5 – LAN** folder and select your OS
2. Run the **PROWinx64.exe** file in the folder
3. Follow the instructions
4. Drivers will be installed automatically

Step 6 – Install Audio Driver

1. Open the **Step 6 – AUDIO** folder and select your OS
2. Run the **0006-64bit_Win7_Win8_Win81_Win10_R279.exe** file in the folder
3. Follow the instructions
4. Drivers will be installed automatically

















































Step 7 – Install Touch Driver

1. Open the **Step 7 - TOUCH** folder and select your OS
2. Run the **Setup.exe** file in the folder
3. Follow the instructions
4. Drivers will be installed automatically

Appendix A

I/O Information



















































A.1 I/O Address Map































Input/output (IO)	
	[0000000000000000 - 000000000000CF7] PCI Express Root Complex
	[0000000000000020 - 000000000000021] Programmable interrupt controller
	[0000000000000024 - 000000000000025] Programmable interrupt controller
	[0000000000000028 - 000000000000029] Programmable interrupt controller
	[000000000000002C - 00000000000002D] Programmable interrupt controller
	[000000000000002E - 00000000000002F] Motherboard resources
	[0000000000000030 - 000000000000031] Programmable interrupt controller
	[0000000000000034 - 000000000000035] Programmable interrupt controller
	[0000000000000038 - 000000000000039] Programmable interrupt controller
	[000000000000003C - 00000000000003D] Programmable interrupt controller
	[0000000000000040 - 000000000000043] System timer
	[000000000000004E - 00000000000004F] Motherboard resources
	[0000000000000050 - 000000000000053] System timer
	[0000000000000061 - 000000000000061] Motherboard resources
	[0000000000000063 - 000000000000063] Motherboard resources
	[0000000000000065 - 000000000000065] Motherboard resources
	[0000000000000067 - 000000000000067] Motherboard resources
	[0000000000000070 - 000000000000070] Motherboard resources
	[0000000000000080 - 000000000000080] Motherboard resources
	[0000000000000092 - 000000000000092] Motherboard resources
	[0000000000000A0 - 0000000000000A1] Programmable interrupt controller
	[0000000000000A4 - 0000000000000A5] Programmable interrupt controller
	[0000000000000A8 - 0000000000000A9] Programmable interrupt controller
	[0000000000000AC - 0000000000000AD] Programmable interrupt controller
	[0000000000000B0 - 0000000000000B1] Programmable interrupt controller
	[0000000000000B2 - 0000000000000B3] Motherboard resources
	[0000000000000B4 - 0000000000000B5] Programmable interrupt controller
	[0000000000000B8 - 0000000000000B9] Programmable interrupt controller
	[0000000000000BC - 0000000000000BD] Programmable interrupt controller
	[00000000000002F8 - 0000000000002FF] Communications Port (COM2)
	[00000000000003F8 - 0000000000003FF] Communications Port (COM1)
	[00000000000004D0 - 00000000000004D1] Programmable interrupt controller
	[0000000000000680 - 000000000000069F] Motherboard resources
	[0000000000000A00 - 0000000000000A0F] Motherboard resources
	[0000000000000A10 - 0000000000000A1F] Motherboard resources
	[0000000000000A20 - 0000000000000A2F] Motherboard resources
	[0000000000000D00 - 000000000000FFFF] PCI Express Root Complex
	[000000000000164E - 000000000000164F] Motherboard resources
	[0000000000001800 - 00000000000018FE] Motherboard resources
	[0000000000001854 - 0000000000001857] Motherboard resources
	[0000000000002000 - 00000000000020FE] Motherboard resources
	[0000000000003000 - 0000000000003FFF] Intel(R) PCI Express Root Port #7 - 9DBE
	[0000000000004000 - 000000000000403F] Intel(R) UHD Graphics 620
	[0000000000004060 - 000000000000407F] Standard SATA AHCI Controller
	[0000000000004080 - 0000000000004083] Standard SATA AHCI Controller
	[0000000000004090 - 0000000000004097] Standard SATA AHCI Controller
	[000000000000EFA0 - 000000000000EFBF] Intel(R) SMBus - 9DA3
	[000000000000FF8 - 000000000000FFFF] Intel(R) Active Management Technology - SOL (COM3)

A.2 Memory Address Map

Memory	Description
[0000000000A0000 - 0000000000BFFFF]	PCI Express Root Complex
[0000000040000000 - 00000000403FFFF]	Motherboard resources
[0000000090000000 - 000000009FFFFFF]	Intel(R) UHD Graphics 620
[0000000090000000 - 00000000DFFFFFF]	PCI Express Root Complex
[00000000A0000000 - 00000000A0FFFFFF]	Intel(R) UHD Graphics 620
[00000000A1100000 - 00000000A11FFFF]	Intel(R) I211 Gigabit Network Connection
[00000000A1100000 - 00000000A11FFFF]	Intel(R) PCI Express Root Port #7 - 9DBE
[00000000A1120000 - 00000000A1123FFF]	Intel(R) I211 Gigabit Network Connection
[00000000A1220000 - 00000000A122FFFF]	Intel(R) USB 3.1 eXtensible Host Controller - 1.10 (Microsoft)
[00000000A123C000 - 00000000A123DFFF]	Standard SATA AHCI Controller
[00000000A1240000 - 00000000A12400FF]	Intel(R) SMBus - 9DA3
[00000000A1241000 - 00000000A12417FF]	Standard SATA AHCI Controller
[00000000A1242000 - 00000000A12420FF]	Standard SATA AHCI Controller
[00000000A1249000 - 00000000A1249FFF]	Intel(R) Thermal Subsystem - 9DF9
[00000000E0000000 - 00000000EFFFFFF]	Motherboard resources
[00000000FC800000 - 00000000FE7FFFF]	PCI Express Root Complex
[00000000FCF00000 - 00000000FCFFFFFF]	High Definition Audio Controller
[00000000FD000000 - 00000000FD69FFF]	Motherboard resources
[00000000FD6A0000 - 00000000FD6AFFFF]	Intel(R) Serial IO GPIO Host Controller - INT34BB
[00000000FD6B0000 - 00000000FD6CFFFF]	Motherboard resources
[00000000FD6D0000 - 00000000FD6DFFFF]	Intel(R) Serial IO GPIO Host Controller - INT34BB
[00000000FD6E0000 - 00000000FD6EFFFF]	Intel(R) Serial IO GPIO Host Controller - INT34BB
[00000000FD6F0000 - 00000000FDFFFFFF]	Motherboard resources
[00000000FE000000 - 00000000FE01FFFF]	Motherboard resources
[00000000FE010000 - 00000000FE010FFF]	Intel(R) SPI (flash) Controller - 9DA4
[00000000FE01CF00 - 00000000FE01CFFF]	Intel(R) Management Engine Interface
[00000000FE01D0000 - 00000000FE01D7FFF]	Intel(R) Dynamic Platform and Thermal Framework Processor Participant
[00000000FE01D8000 - 00000000FE01DBFFF]	High Definition Audio Controller
[00000000FE01DC000 - 00000000FE01DCFFF]	Intel(R) Serial IO I2C Host Controller - 9DEB
[00000000FE01DD000 - 00000000FE01DDFFF]	Intel(R) Serial IO I2C Host Controller - 9DE8
[00000000FE01DE000 - 00000000FE01DEFFF]	Intel(R) Serial IO I2C Host Controller - 9DE8
[00000000FE01DF000 - 00000000FE01DFFF]	Intel(R) Active Management Technology - SOL (COM3)
[00000000FE01E0000 - 00000000FE01FFFF]	Intel(R) Ethernet Connection (6) I219-LM
[00000000FE200000 - 00000000FE7FFFF]	Motherboard resources
[00000000FED00000 - 00000000FED003FF]	High precision event timer
[00000000FED10000 - 00000000FED17FFF]	Motherboard resources
[00000000FED18000 - 00000000FED18FFF]	Motherboard resources
[00000000FED19000 - 00000000FED19FFF]	Motherboard resources
[00000000FED20000 - 00000000FED33FFF]	Motherboard resources
[00000000FED45000 - 00000000FED8FFFF]	Motherboard resources
[00000000FED90000 - 00000000FED93FFF]	Motherboard resources
[00000000FEE00000 - 00000000FEEFFFF]	Motherboard resources
[00000000FF000000 - 00000000FFFFFFF]	Motherboard resources

A.3 IRQ Mapping Chart

Interrupt request (IRQ)	
 (ISA) 0x00000000 (00)	System timer
 (ISA) 0x00000003 (03)	Communications Port (COM2)
 (ISA) 0x00000004 (04)	Communications Port (COM1)
 (ISA) 0x0000000E (14)	Intel(R) Serial IO GPIO Host Controller - INT34BB
 (ISA) 0x00000037 (55)	Microsoft ACPI-Compliant System
 (ISA) 0x00000038 (56)	Microsoft ACPI-Compliant System
 (ISA) 0x00000039 (57)	Microsoft ACPI-Compliant System
 (ISA) 0x0000003A (58)	Microsoft ACPI-Compliant System
 (ISA) 0x0000003B (59)	Microsoft ACPI-Compliant System
 (ISA) 0x0000003C (60)	Microsoft ACPI-Compliant System
 (ISA) 0x0000003D (61)	Microsoft ACPI-Compliant System
 (ISA) 0x0000003E (62)	Microsoft ACPI-Compliant System
 (ISA) 0x0000003F (63)	Microsoft ACPI-Compliant System
 (ISA) 0x00000040 (64)	Microsoft ACPI-Compliant System
 (ISA) 0x00000041 (65)	Microsoft ACPI-Compliant System
 (ISA) 0x00000042 (66)	Microsoft ACPI-Compliant System
 (ISA) 0x00000043 (67)	Microsoft ACPI-Compliant System
 (ISA) 0x00000044 (68)	Microsoft ACPI-Compliant System
 (ISA) 0x00000045 (69)	Microsoft ACPI-Compliant System
 (ISA) 0x00000046 (70)	Microsoft ACPI-Compliant System
 (ISA) 0x00000047 (71)	Microsoft ACPI-Compliant System
 (ISA) 0x00000048 (72)	Microsoft ACPI-Compliant System
 (ISA) 0x00000049 (73)	Microsoft ACPI-Compliant System
 (ISA) 0x0000004A (74)	Microsoft ACPI-Compliant System
 (ISA) 0x0000004B (75)	Microsoft ACPI-Compliant System
 (ISA) 0x0000004C (76)	Microsoft ACPI-Compliant System
 (ISA) 0x0000004D (77)	Microsoft ACPI-Compliant System
 (ISA) 0x0000004E (78)	Microsoft ACPI-Compliant System
 (ISA) 0x0000004F (79)	Microsoft ACPI-Compliant System
 (ISA) 0x00000050 (80)	Microsoft ACPI-Compliant System
 (ISA) 0x00000051 (81)	Microsoft ACPI-Compliant System
 (ISA) 0x00000052 (82)	Microsoft ACPI-Compliant System
 (ISA) 0x00000053 (83)	Microsoft ACPI-Compliant System
 (ISA) 0x00000054 (84)	Microsoft ACPI-Compliant System
 (ISA) 0x00000055 (85)	Microsoft ACPI-Compliant System
 (ISA) 0x00000056 (86)	Microsoft ACPI-Compliant System
 (ISA) 0x00000057 (87)	Microsoft ACPI-Compliant System
 (ISA) 0x00000058 (88)	Microsoft ACPI-Compliant System
 (ISA) 0x00000059 (89)	Microsoft ACPI-Compliant System
 (ISA) 0x0000005A (90)	Microsoft ACPI-Compliant System
 (ISA) 0x0000005B (91)	Microsoft ACPI-Compliant System
 (ISA) 0x0000005C (92)	Microsoft ACPI-Compliant System
 (ISA) 0x0000005D (93)	Microsoft ACPI-Compliant System
 (ISA) 0x0000005E (94)	Microsoft ACPI-Compliant System
 (ISA) 0x0000005F (95)	Microsoft ACPI-Compliant System
 (ISA) 0x00000060 (96)	Microsoft ACPI-Compliant System
 (ISA) 0x00000061 (97)	Microsoft ACPI-Compliant System
 (ISA) 0x00000062 (98)	Microsoft ACPI-Compliant System
 (ISA) 0x00000063 (99)	Microsoft ACPI-Compliant System
 (ISA) 0x00000064 (100)	Microsoft ACPI-Compliant System
 (ISA) 0x00000065 (101)	Microsoft ACPI-Compliant System

	(ISA) 0x000001DF (479)	Microsoft ACPI-Compliant System
	(ISA) 0x000001E0 (480)	Microsoft ACPI-Compliant System
	(ISA) 0x000001E1 (481)	Microsoft ACPI-Compliant System
	(ISA) 0x000001E2 (482)	Microsoft ACPI-Compliant System
	(ISA) 0x000001E3 (483)	Microsoft ACPI-Compliant System
	(ISA) 0x000001E4 (484)	Microsoft ACPI-Compliant System
	(ISA) 0x000001E5 (485)	Microsoft ACPI-Compliant System
	(ISA) 0x000001E6 (486)	Microsoft ACPI-Compliant System
	(ISA) 0x000001E7 (487)	Microsoft ACPI-Compliant System
	(ISA) 0x000001E8 (488)	Microsoft ACPI-Compliant System
	(ISA) 0x000001E9 (489)	Microsoft ACPI-Compliant System
	(ISA) 0x000001EA (490)	Microsoft ACPI-Compliant System
	(ISA) 0x000001EB (491)	Microsoft ACPI-Compliant System
	(ISA) 0x000001EC (492)	Microsoft ACPI-Compliant System
	(ISA) 0x000001ED (493)	Microsoft ACPI-Compliant System
	(ISA) 0x000001EE (494)	Microsoft ACPI-Compliant System
	(ISA) 0x000001EF (495)	Microsoft ACPI-Compliant System
	(ISA) 0x000001F0 (496)	Microsoft ACPI-Compliant System
	(ISA) 0x000001F1 (497)	Microsoft ACPI-Compliant System
	(ISA) 0x000001F2 (498)	Microsoft ACPI-Compliant System
	(ISA) 0x000001F3 (499)	Microsoft ACPI-Compliant System
	(ISA) 0x000001F4 (500)	Microsoft ACPI-Compliant System
	(ISA) 0x000001F5 (501)	Microsoft ACPI-Compliant System
	(ISA) 0x000001F6 (502)	Microsoft ACPI-Compliant System
	(ISA) 0x000001F7 (503)	Microsoft ACPI-Compliant System
	(ISA) 0x000001F8 (504)	Microsoft ACPI-Compliant System
	(ISA) 0x000001F9 (505)	Microsoft ACPI-Compliant System
	(ISA) 0x000001FA (506)	Microsoft ACPI-Compliant System
	(ISA) 0x000001FB (507)	Microsoft ACPI-Compliant System
	(ISA) 0x000001FC (508)	Microsoft ACPI-Compliant System
	(ISA) 0x000001FD (509)	Microsoft ACPI-Compliant System
	(ISA) 0x000001FE (510)	Microsoft ACPI-Compliant System
	(ISA) 0x000001FF (511)	Microsoft ACPI-Compliant System
	(PCI) 0x00000010 (16)	High Definition Audio Controller
	(PCI) 0x00000010 (16)	Intel(R) Dynamic Platform and Thermal Framework Processor Participant
	(PCI) 0x00000010 (16)	Intel(R) Serial IO I2C Host Controller - 9DE8
	(PCI) 0x00000013 (19)	Intel(R) Active Management Technology - SOL (COM3)
	(PCI) 0x00000013 (19)	Intel(R) Serial IO I2C Host Controller - 9DEB
	(PCI) 0xFFFFFFF2 (-14)	Intel(R) Management Engine Interface
	(PCI) 0xFFFFFFF3 (-13)	Intel(R) Ethernet Connection (6) I219-LM
	(PCI) 0xFFFFFFF4 (-12)	Intel(R) UHD Graphics 620
	(PCI) 0xFFFFFFF5 (-11)	Intel(R) USB 3.1 eXtensible Host Controller - 1.10 (Microsoft)
	(PCI) 0xFFFFFFF6 (-10)	Intel(R) I211 Gigabit Network Connection
	(PCI) 0xFFFFFFF7 (-9)	Intel(R) I211 Gigabit Network Connection
	(PCI) 0xFFFFFFF8 (-8)	Intel(R) I211 Gigabit Network Connection
	(PCI) 0xFFFFFFF9 (-7)	Intel(R) I211 Gigabit Network Connection
	(PCI) 0xFFFFFFFA (-6)	Intel(R) I211 Gigabit Network Connection
	(PCI) 0xFFFFFFFB (-5)	Intel(R) I211 Gigabit Network Connection
	(PCI) 0xFFFFFFF4 (-4)	Standard SATA AHCI Controller
	(PCI) 0xFFFFFFF5 (-3)	Intel(R) PCI Express Root Port #1 - 9DB8
	(PCI) 0xFFFFFFF6 (-2)	Intel(R) PCI Express Root Port #7 - 9DBE

Appendix B

Mating Connectors and Cables

B.1 Mating Connectors and Cables

Connector Label	Function	Mating Connector		Available Cable	Cable P/N
		Vendor	Model no		
CN1	+5Vout Connector	JST	PHR-2	2 Pins for HDD Power	1702150155
CN2	SATA Connector	Molex	88750-5318	SATA Cable	1709070500
CN3	+9~24V Vin Connector	N/A	N/A	Power Cable	1702002010
CN5	Audio Connector	Molex	51021-1000	Audio Cable	1709100254
CN6	External +5VSB Power Input and PS_ON#	JST	PHR-3	ATX Cable	170220020B
CN8	COM Port 1 Connector	Molex	51021-0900	Serial Port Cable	1701090150
CN9	COM Port 2 Connector	Molex	51021-0900	Serial Port Cable	1701090150
CN13	LVDS Inverter Connector	JST	PHR-5	N/A	N/A
CN14	LVDS Connector	HIROSE	DF13-30DS-1.25C	N/A	N/A
CN15	USB Port Connector	Molex	51021-0500	USB Wafer Cable	1700050207
CN17	USB Port Connector	Molex	51021-0500	USB Wafer Cable	1700050207
CN18	I2C/SM BUS/Debug Connector	Molex	51021-1200	I2C/SM BUS Cable	1703120130

Connector Label	Function	Mating Connector		Available Cable	Cable P/N
		Vendor	Model no		
CN19	Digital I/O Connector	Neltron	2026B-10	N/A	N/A
CN21	Touch Screen Connector	JST	SHR-9V-S-B	N/A	N/A
CN22	CPU Fan Connector	Molex	22-01-2035	N/A	N/A
CN23	External RTC Connector	Molex	51021-0200	Battery Cable	175011901C