

Click boards™

Ever-growing range of standardized add-on boards

WiFi, LoRa, BLE, GSM, GPS, OLED, speech recognition, environmental sensors, movement sensors, biosensors, LEDs, ADCs, relays - you name it, we got it. There are hundreds of Click boards available.



3G Click (USA)

5V | 3.3V | SPI | I2C

UART | GPIO | PWM | AN

UG95 3G UMTS/HSPA module. With SIM card slot, Audio/Mic jack, micro USB port.

MSRP - \$89⁰⁰
MIKROE-2296



3G Click (EU/AUS)

5Va | 3.3V | SPI | I2C

UART | GPIO | PWM | AN

UG95 3G UMTS/HSPA module. With SIM card slot, Audio/Mic jack, micro USB port.

MSRP - \$89⁰⁰
MIKROE-2226



3G SARA Click

5V | 3.3V | SPI | I2C

UART | GPIO | PWM | AN

With UMTS/HSPA cellular modem – the u-blox U201, from the SARA series.

MSRP - \$99⁰⁰
MIKROE-2244



4G LTE-E Click

5V | 3.3V | SPI | I2C

UART | GPIO | PWM | AN

It features the LARA-R211 multi-mode cellular module from u-blox.

MSRP - \$115⁰⁰
MIKROE-2527



4G LTE-NA Click

5V | 3.3V | SPI | I2C

UART | GPIO | PWM | AN

It features the LARA-R204 multi-mode cellular module from u-blox.

MSRP - \$115⁰⁰
MIKROE-2535



6LoWPAN C Click

5V | 3.3V | SPI | I2C

UART | GPIO | PWM | AN

TI's CC2520, 2.4GHz ZigBee®/IEEE 802.15.4 RF transceiver.

MSRP – \$26⁰⁰
MIKROE-2219



6LoWPAN T Click

5V | 3.3V | SPI | I2C

UART | GPIO | PWM | AN

TI's CC2520, 2.4GHz ZigBee®/IEEE 802.15.4 RF transceiver.

MSRP – \$26⁰⁰
MIKROE-2218

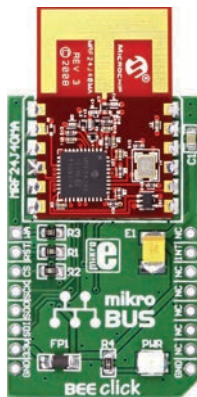

BEE Click

5V | 3.3V | SPI | I2C

UART | GPIO | PWM | AN

Microchip's MRF24J-40MA 2.4 GHz IEEE 802.15.4 radio transceiver module.

MSRP – \$29⁰⁰
MIKROE-987



BLE 2 Click

5V | 3.3V | SPI | I2C

UART | GPIO | PWM | AN

With RN4020 Bluetooth 4.1 module. Can be set up both as a client or a server.

MSRP – \$30⁰⁰
MIKROE-1715



BLE 3 Click

5V | 3.3V | SPI | I2C

UART | GPIO | PWM | AN

It features NINA-B1 Bluetooth 4.2 module from u-blox.

MSRP – \$39⁰⁰
MIKROE-2471



BLE P Click

5V | 3.3V | SPI | I2C
UART | GPIO | PWM | AN

With nRF8001 Bluetooth 4.0 peripheral device. Open source Android app available.

MSRP – \$25⁰⁰
MIKROE-1597



Bluetooth Click

5V | 3.3V | SPI | I2C
UART | GPIO | PWM | AN

It features the RN-41 low power, class 1 Bluetooth radio module.

MSRP – \$39⁰⁰
MIKROE-958



BT Audio Click

5V | 3.3V | SPI | I2C
UART | GPIO | PWM | AN

With RN52 Bluetooth audio module and on-board 3.5mm jacks for a mic and a speaker.

MSRP – \$49⁰⁰
MIKROE-2399

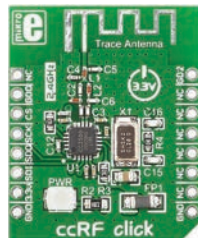

ccRF Click

5V | 3.3V | SPI | I2C
UART | GPIO | PWM | AN

With CC2500 low-power 2.4 GHz RF transceiver and PCB trace antenna.

MSRP – \$22⁰⁰
MIKROE-1435

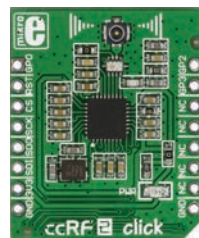

ccRF 2 Click

5V | 3.3V | SPI | I2C
UART | GPIO | PWM | AN

With CC1120, high performance radio transceiver for ISRM and SRD bands.

MSRP – \$36⁰⁰
MIKROE-1716

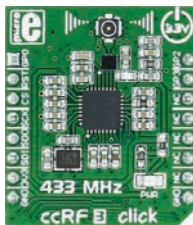

ccRF 3 Click

5V | 3.3V | SPI | I2C
 UART | GPIO | PWM | AN

Carries the CC1120 high-performance RF transceiver for narrow-band systems from TI.

MSRP – \$36⁰⁰
 MIKROE-2389



EnOcean Click

5V | 3.3V | SPI | I2C
 UART | GPIO | PWM | AN

With TCM 310 transceiver - bidirectional gateway for EnOcean's 868 MHz radio systems.

MSRP – \$39⁰⁰
 MIKROE-1908



EnOcean 2 Click

5V | 3.3V | SPI | I2C
 UART | GPIO | PWM | AN

With TCM 515Z transceiver, based on the 2.4 GHz IEEE 802.15.4 radio standard.

MSRP – \$39⁰⁰
 MIKROE-2521

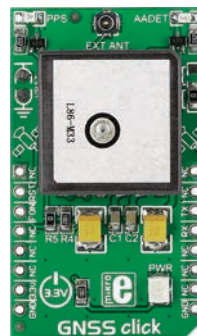

GNSS Click

5V | 3.3V | SPI | I2C
 UART | GPIO | PWM | AN

Quectel's L86 GNSS module with a patch antenna and an external antenna connector.

MSRP – \$46⁰⁰
 MIKROE-1850



GNSS 2 Click

5V | 3.3V | SPI | I2C
 UART | GPIO | PWM | AN

Quectel's L76 module and SMA antenna connector. GPS + GLONASS.

MSRP – \$39⁰⁰
 MIKROE-1887



GNSS 3 Click

5V | 3.3V | SPI | I2C
UART | GPIO | PWM | AN

Carries SIM33ELAGNSS module with an integrated antenna and an external antenna connector.

MSRP – \$339⁰⁰
MIKROE-1895



GNSS 4 Click

5V | 3.3V | SPI | I2C
UART | GPIO | PWM | AN

It features SAM-M8Q patch antenna module from u-blox.

MSRP – \$44⁰⁰
MIKROE-2045



GNSS 5 Click

5V | 3.3V | SPI | I2C
UART | GPIO | PWM | AN

It features NEO-M8N GNSS receiver module from u-blox.

MSRP – \$41⁰⁰
MIKROE-2670



GPS Click

5V | 3.3V | SPI | I2C
UART | GPIO | PWM | AN

It carries LEA-6S high-performance position engine from u-blox.

MSRP – \$49⁰⁰
MIKROE-1032



GPS 3 Click

5V | 3.3V | SPI | I2C
UART | GPIO | PWM | AN

With Quectel's L80, high-sensitivity GPS module with a patch antenna.

MSRP – \$44⁰⁰
MIKROE-1714



GSM-GPS Click

5V 3.3V SPI I2C

UART GPIO PWM AN

With SIM808, GSM/GPRS and GPS module. Two antenna connectors, SIM card slot, a micro USB connector.

MSRP – \$85⁰⁰
MIKROE-2382



GSM Click

5V 3.3V SPI I2C

UART GPIO PWM AN

With quad-band GL865-QUAD GSM/ GPRS module, onboard antenna connector and SIM card socket.

MSRP – \$49⁰⁰
MIKROE-1298



GSM 2 Click

5V 3.3V SPI I2C

UART GPIO PWM AN

With Quectel's M95 FA quad-band GSM/GPRS module. 85.6 kbps GPRS data transfer.

MSRP – \$44⁰⁰
MIKROE-1375



GSM 3 Click

5V 3.3V SPI I2C

UART GPIO PWM AN

With SIM800H quad-band GSM/GPRS module. 85.6 kbps GPRS data transfer.

MSRP – \$57⁰⁰
MIKROE-1720



GSM/GNSS Click

5V 3.3V SPI I2C

UART GPIO PWM AN

Quectel's MC60 quad-band GSM/GPRS/GNSS module. GPS/GNSS location tracking with GSM.

MSRP – \$79⁰⁰
MIKROE-2439



GSM/GNSS 2 Click

5V 3.3V SPI I2C
UART GPIO PWM AN

With SIM868 quad-band GSM/GPRS module. GPS/GNSS location tracking with GSM.

MSRP – \$69⁰⁰
MIKROE-2440

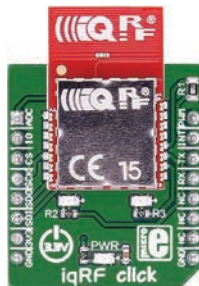

iQRF Click

5V 3.3V SPI I2C
UART GPIO PWM AN

With DCTR-76DA RF transceiver, operating in the 868/916 MHz frequency.

MSRP – \$43⁰⁰
MIKROE-2586



iQRF 2 Click

5V 3.3V SPI I2C
UART GPIO PWM AN

With DCTR-72DAT RF transceiver, operating in the 868/916 MHz frequency.

MSRP – \$49⁰⁰
MIKROE-2587

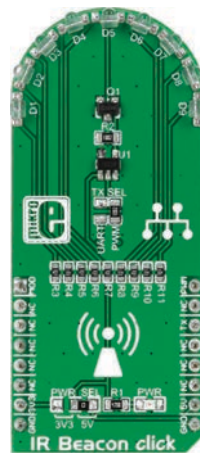

IR Beacon Click

5V 3.3V SPI I2C
UART GPIO PWM AN

Functions as a beacon device with nine VSMB-2948SL high speed infrared emitting diodes.

MSRP – \$21⁰⁰
MIKROE-1939

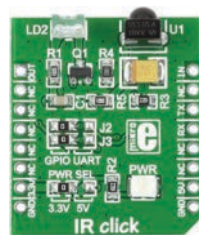

IR Click

5V 3.3V SPI I2C
UART GPIO PWM AN

Features TSOP3838 IR 38 kHz receiver module as well as QEE113 IR emitting diode.

MSRP – \$9⁵⁰
MIKROE-1377

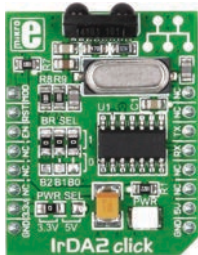

IrDA2 Click

5V 3.3V SPI I2C
UART GPIO PWM AN

With TFDU4101 infrared transceiver module and MCP2120 infrared encoder/decoder.

MSRP - \$25⁰⁰
MIKROE-1195



LoRa RF Click

5V 3.3V SPI I2C
UART GPIO PWM AN

With RN2483 LoRa Sub-GHz, 433/868 MHz European R&TTE Directive Assessed Radio Modem.

MSRP - \$54⁰⁰
MIKROE-1997



LoRa RF 2 Click

5V 3.3V SPI I2C
UART GPIO PWM AN

With RN2903 915 MHz Radio Modem compliant with regulations for use in the USA, CA, AU, NZ.

MSRP - \$54⁰⁰
MIKROE-2225



LoRa 3 Click

5V 3.3V SPI I2C
UART GPIO PWM AN

A LoRa technology-based SRD transceiver, operates at a sub-gigahertz frequency of 868MHz.

MSRP - \$52⁰⁰
MIKROE-2933



LoRa 4 Click

5V 3.3V SPI I2C
UART GPIO PWM AN

A LoRa RF technology based SRD transceiver, operates at a sub-gigahertz frequency of 868MHz.

MSRP - \$52⁰⁰
MIKROE-2934



NFC Tag Click

5V 3.3V SPI I2C
UART GPIO PWM AN

With M24SR64 NFC/RFID tag IC with a dual interface and 8KB of high-reliability EEPROM built-in.

MSRP – \$12⁰⁰
MIKROE-1726



NFC Tag 2 Click

5V 3.3V SPI I2C
UART GPIO PWM AN

Carries NT3H1101 NTAG I2C energy harvesting NFC Forum Type 2 Tag from NXP.

MSRP – \$12⁰⁰
MIKROE-2462



nRF C Click

5V 3.3V SPI I2C
UART GPIO PWM AN

With nRF24L01P 2.4 GHz transceiver. Air data rates of 250 Kbps, 1 Mbps and 2 Mbps.

MSRP – \$19⁰⁰
MIKROE-1304



nRF S Click

5V 3.3V SPI I2C
UART GPIO PWM AN

With nRF24L01P 2.4 GHz transceiver. 250 Kbps, 1 Mbps and 2 Mbps air data rates.

MSRP – \$19⁰⁰
MIKROE-1836



nRF T Click

5V 3.3V SPI I2C
UART GPIO PWM AN

With nRF24L01P 2.4 GHz transceiver module. Air data rates of 250 Kbps, 1 Mbps and 2 Mbps.

MSRP – \$16⁰⁰
MIKROE-1305

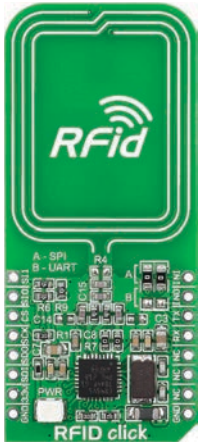

RFid Click

5V | 3.3V | SPI | I2C
 UART | GPIO | PWM | AN

With CR95HF 13.56 MHz contactless Rfid transceiver, and trace antenna.

MSRP - \$29⁰⁰
 MIKROE-1434

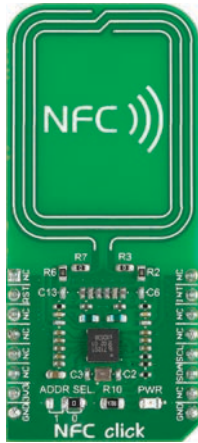

NFC Click

5V | 3.3V | SPI | I2C
 UART | GPIO | PWM | AN

With near field communications controller PN7120 IC from NXP.

MSRP - \$34⁰⁰
 MIKROE-2395

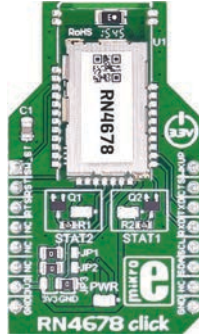

RN4678 Click

5V | 3.3V | SPI | I2C
 UART | GPIO | PWM | AN

It carries RN4678 Bluetooth® 4.2 dual mode module from Microchip.

MSRP - \$29⁰⁰
 MIKROE-2545

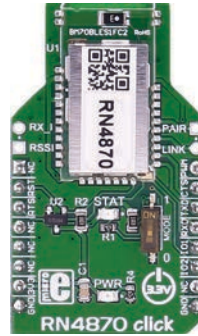

RN4870 Click

5V | 3.3V | SPI | I2C
 UART | GPIO | PWM | AN

It carries RN4870 Bluetooth® 4.2 low energy module from Microchip.

MSRP - \$33⁰⁰
 MIKROE-2543



RN4871 Click

5V | 3.3V | SPI | I2C
 UART | GPIO | PWM | AN

It carries RN4871 Bluetooth® 4.2 low energy module from Microchip.

MSRP - \$33⁰⁰
 MIKROE-2544



tRF Click

5V | 3.3V | SPI | I2C
UART | GPIO | PWM | AN

With Telit's LE70-868 — a 868 MHz transceiver module with embedded stack.

MSRP – \$59⁰⁰
MIKROE-1535

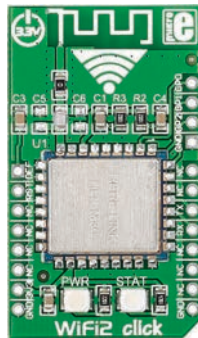

WiFi 2 Click

5V | 3.3V | SPI | I2C
UART | GPIO | PWM | AN

With HLM-K30 module. Can be set up with either a static or dynamic IP address.

MSRP – \$29⁰⁰
MIKROE-1768



WiFi 3 Click

5V | 3.3V | SPI | I2C
UART | GPIO | PWM | AN

With ESP8266 module. TCP/IP stack. Supports Wi-Fi Direct [p2p]. 6 GPIO pins.

MSRP – \$27⁰⁰
MIKROE-1769



WiFi 4 Click

5V | 3.3V | SPI | I2C
UART | GPIO | PWM | AN

With SPWF01SA standalone WiFi module. Built-in 2.45 GHz ISM band antenna.

MSRP – \$49⁰⁰
MIKROE-1913



WiFi 5 Click

5V | 3.3V | SPI | I2C
UART | GPIO | PWM | AN

With Gainspan's GS1500M 802.11b/g/n Low Power Wi-Fi module with a PCB trace antenna.

MSRP – \$29⁰⁰
MIKROE-2274

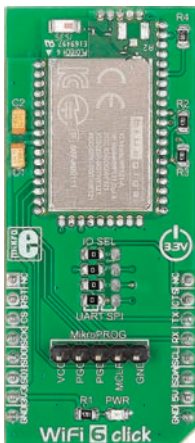

WiFi 6 Click

5V | 3.3V | SPI | I2C

UART | GPIO | PWM | AN

With WF121-A self-contained WiFi module. 2.4GHz band IEEE 802.11 b/g/n radio.

MSRP – \$69⁰⁰
MIKROE-2043

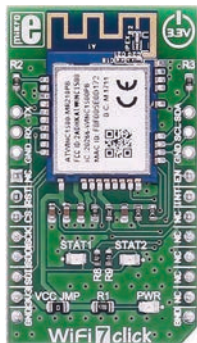

WiFi 7 Click

5V | 3.3V | SPI | I2C

UART | GPIO | PWM | AN

With ATWINC1510-MR210PB IEEE 802.11 b/g/n module, 20MHz solution.

MSRP – \$29⁰⁰
MIKROE-2046



WiFi ESP Click

5V | 3.3V | SPI | I2C

UART | GPIO | PWM | AN

With ESP-WROOM-02 module that integrates ESP8266EX. In AP WiFi and WiFi client mode.

MSRP – \$15⁰⁰
MIKROE-2542



WiFi PLUS Click

5V | 3.3V | SPI | I2C

UART | GPIO | PWM | AN

With MRF24WB-OMA 2.4GHz, IEEE std. 802.11 module and MCW1001 controller.

MSRP – \$45⁰⁰
MIKROE-1135



WiFly Click

5V | 3.3V | SPI | I2C

UART | GPIO | PWM | AN

With RN-131 embedded wireless LAN module. Qualified 2.4-GHz IEEE 802.11 b/g transceiver.

MSRP – \$69⁰⁰
MIKROE-1937



AnyNet 2G Click

5V | 3.3V | SPI | I2C
UART | GPIO | PWM | AN

WiFi module with integrated IPv4 TCP/IP stack and built-in network protocols.

MSRP – \$69⁰⁰
MIKROE-2747



AnyNet 3G-EA Click

5V | 3.3V | SPI | I2C
UART | GPIO | PWM | AN

A secure connection with the AWS over the air (OTA), by utilizing the Quectel UG95 3G module.

MSRP – \$89⁰⁰
MIKROE-2975



CC3100 Click

5V | 3.3V | SPI | I2C
UART | GPIO | PWM | AN

Carries low power, high security Wi-Fi CC3100 module. Support for 802.11n.

MSRP – \$49⁰⁰
MIKROE-2336



OOK RX Click

5V | 3.3V | SPI | I2C
UART | GPIO | PWM | AN

A wireless receiver that operates at the frequency of 433MHz [sub-GHz].

MSRP – \$19⁰⁰
MIKROE-2902



OOK TX Click

5V | 3.3V | SPI | I2C
UART | GPIO | PWM | AN

A wireless transmitter that operates at the frequency of 433MHz [sub-GHz].

MSRP – \$19⁰⁰
MIKROE-2903



WiFi NINA Click

5V | 3.3V | SPI | I2C
 UART | GPIO | PWM | AN

A standalone WiFi module, with the state-of-the-art NINA-W132 module from u-blox.

MSRP – \$45⁰⁰
 MIKROE-2921



MiWi Click

5V | 3.3V | SPI | I2C
 UART | GPIO | PWM | AN

A subgigahertz radio transceiver which offers a reliable FSK or OOK communication solution.

MSRP – \$17⁰⁰
 MIKROE-2924



MiWi 2 Click

5V | 3.3V | SPI | I2C
 UART | GPIO | PWM | AN

A subgigahertz radio transceiver which offers a reliable FSK or OOK communication solution.

MSRP – \$17⁰⁰
 MIKROE-2925



M-BUS RF Click

5V | 3.3V | SPI | I2C
 UART | GPIO | PWM | AN

With ME70-169 RF wireless module. Unlicensed ISM frequency band 169.400-169.475 MHz.

MSRP – \$54⁰⁰
 MIKROE-2048



SPIRIT Click

5V | 3.3V | SPI | I2C
 UART | GPIO | PWM | AN

With SP1ML 868MHz ultra low-power RF module. Memory: 16 kB RAM and 128 kB Flash.

MSRP – \$39⁰⁰
 MIKROE-2568



XBEE Click

5V | 3.3V | SPI | I2C
UART | GPIO | PWM | AN

Xbee® and Zig-
bee-compliant XB-
24CZ7PIS-004 module
with a PCB antenna.

MSRP – \$59⁰⁰
MIKROE-1599

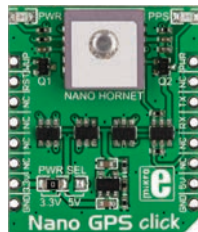

NANO GPS Click

5V | 3.3V | SPI | I2C
UART | GPIO | PWM | AN

With Nano Hornet,
world's smallest GPS
module with an inte-
grated antenna.

MSRP – \$45⁰⁰
MIKROE-1912



GPS 4 Click

5V | 3.3V | SPI | I2C
UART | GPIO | PWM | AN

GPS 4 click carries
the L70 compact GPS
module from Quectel,
with external antenna.

MSRP – \$34⁰⁰
MIKROE-2704



GSM 4 Click

5V | 3.3V | SPI | I2C
UART | GPIO | PWM | AN

Compact quad-band
GSM solution, featur-
ing the quad-band
SARA-G350 module.

MSRP – \$74⁰⁰
MIKROE-2388



LTE IoT Click

5V | 3.3V | SPI | I2C
UART | GPIO | PWM | AN

Compact quad-band
GSM solution, featur-
ing the quad-band
SARA-G350 module.

MSRP – \$79⁰⁰
MIKROE-3072



LTE IoT 2 Click

5V | 3.3V | SPI | I2C
 UART | GPIO | PWM | AN

Allows connection to the LTE networks, featuring Quectel BG96 LTE module.

MSRP – \$69⁰⁰
 MIKROE-3144



SigFox Click

5V | 3.3V | SPI | I2C
 UART | GPIO | PWM | AN

Carries the SN10-11, a fully integrated Sigfox™ certified module by InnoComm.

MSRP – \$25⁰⁰
 MIKROE-2534



SigFox 2 Click

5V | 3.3V | SPI | I2C
 UART | GPIO | PWM | AN

Carries the SN10-12, a fully integrated Sigfox™ certified module by InnoComm.

MSRP – \$25⁰⁰
 MIKROE-3039



SigFox 3 Click

5V | 3.3V | SPI | I2C
 UART | GPIO | PWM | AN

Carries the SN10-13, a fully integrated Sigfox™ certified module by InnoComm.

MSRP – \$25⁰⁰
 MIKROE-3163



NB IoT Click

5V | 3.3V | SPI | I2C
 UART | GPIO | PWM | AN

Allows LTE Cat NB1 connectivity by utilizing Quectel BC95-G

MSRP – \$52⁰⁰
 MIKROE-3294

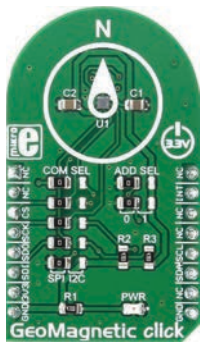

GeoMagnetic Click

5V | 3.3V | SPI | I2C
 UART | GPIO | PWM | AN

Measures the geomagnetic field in three perpendicular axes. The onboard sensor uses FlipCore from Bosch.

MSRP – \$15⁰⁰
 MIKROE-2935

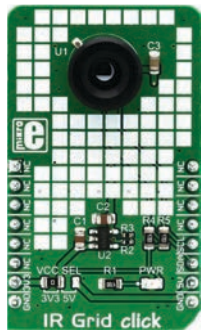

IR Grid Click

5V | 3.3V | SPI | I2C
 UART | GPIO | PWM | AN

Equipped with the MLX90621BAD, a 16x4 IR array sensor, from Melexis.

MSRP – \$69⁰⁰
 MIKROE-2622



Moisture Click

5V | 3.3V | SPI | I2C
 UART | GPIO | PWM | AN

FDC2112 IC, a very precise 12bit capacitance to digital converter, from Texas Instruments.

MSRP – \$19⁰⁰
 MIKROE-3084

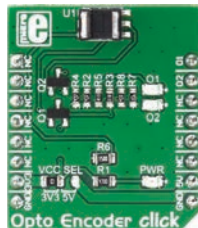

Opto Encoder Click

5V | 3.3V | SPI | I2C
 UART | GPIO | PWM | AN

Uses the TCUT1600X01, a tall dome dual channel transmissive optical sensor from Vishay.

MSRP – \$9⁰⁰
 MIKROE-2549

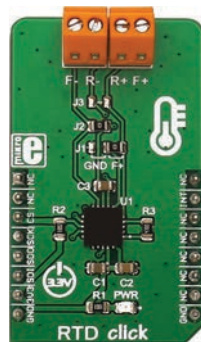

RTD Click

5V | 3.3V | SPI | I2C
 UART | GPIO | PWM | AN

It is based on MAX31865 resistance to digital converter optimized for RTDs.

MSRP – \$19⁰⁰
 MIKROE-2815

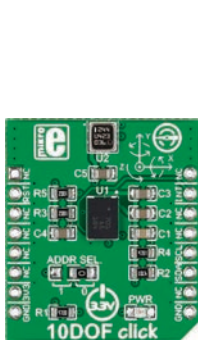

10DOF Click

5V | 3.3V | SPI | I2C

UART | GPIO | PWM | AN

With BN0055, a 9-axis absolute orientation sensor and BMP180, a digital pressure sensor.

MSRP – \$49⁰⁰
MIKROE-2073

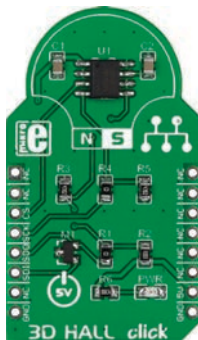

3D Hall Click

5V | 3.3V | SPI | I2C

UART | GPIO | PWM | AN

With MLX90333 3-axis Hall sensor. Detects the position of any magnet in nearby space.

MSRP – \$25⁰⁰
MIKROE-1987

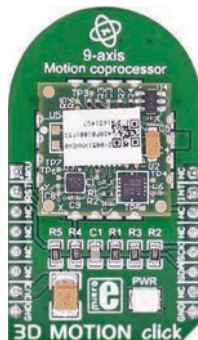

3D Motion Click

5V | 3.3V | SPI | I2C

UART | GPIO | PWM | AN

MM7150 9-axis sensor fusion motion module and SSC7150 motion coprocessor.

MSRP – \$59⁰⁰
MIKROE-1877

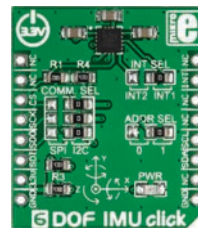

6DOF IMU Click

5V | 3.3V | SPI | I2C

UART | GPIO | PWM | AN

STM's LSM6DS33TR 6-axis IMU with 3-axis gyroscope and 3-axis accelerometer.

MSRP – \$49⁰⁰
MIKROE-1298

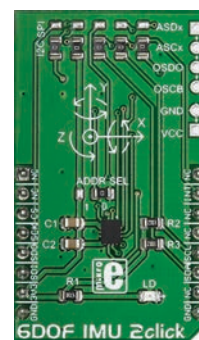

6DOF IMU 2 Click

5V | 3.3V | SPI | I2C

UART | GPIO | PWM | AN

With BMI160 low power IMU. For precise acceleration and gyroscopic measurement.

MSRP – \$24⁰⁰
MIKROE-2337

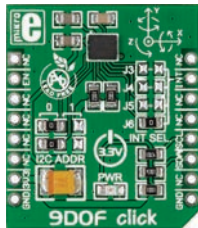

9DOF Click

5V | 3.3V | SPI | I2C
 UART | GPIO | PWM | AN

LMS9DS1 inertial measurement module - 3D accelerometer, gyroscope and magnetometer.

MSRP - \$24⁰⁰
 MIKROE-1941

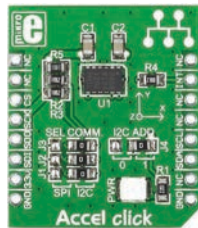

Accel Click

5V | 3.3V | SPI | I2C
 UART | GPIO | PWM | AN

With ADXL345 3-axis accelerometer. 13-bit measurement, embedded FIFO technologies.

MSRP - \$19⁰⁰
 MIKROE-1194

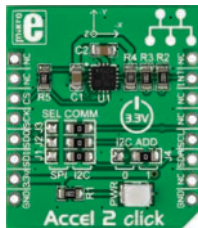

Accel 2 Click

5V | 3.3V | SPI | I2C
 UART | GPIO | PWM | AN

LIS3DSH IC 3-axis accel-erometer. Embedded FIFO buffer and 2 programmable state machines.

MSRP - \$19⁰⁰
 MIKROE-1905

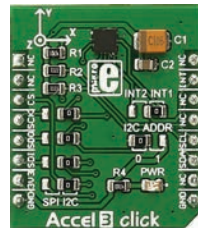

Accel 3 Click

5V | 3.3V | SPI | I2C
 UART | GPIO | PWM | AN

H3LIS331DL 3-axis linear accelerometer. Dynamically selectable scales $\pm 100g/\pm 200g/\pm 400g$.

MSRP - \$21⁰⁰
 MIKROE-2102



Air quality Click

5V | 3.3V | SPI | I2C
 UART | GPIO | PWM | AN

MQ-135 sensor for detecting gases - ammonia, nitrogen oxides, benzene, smoke, CO₂.

MSRP - \$16⁵⁰
 MIKROE-1630

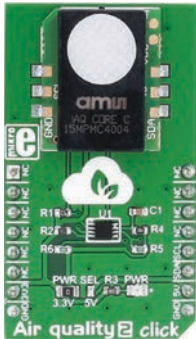

Air quality 2 Click

5V 3.3V SPI I2C

UART GPIO PWM AN

IAQ-Core that measures VOC levels and provides CO2 equivalent and TVOC equivalent predictions.

MSRP – \$79⁰⁰
MIKROE-2529

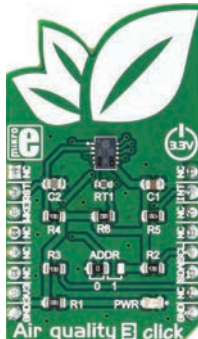

Air quality 3 Click

5V 3.3V SPI I2C

UART GPIO PWM AN

Equipped with the CCS811, an ultra-low power digital gas sensor for monitoring the indoor air quality (IAQ).

MSRP – \$29⁰⁰
MIKROE-2953



Air quality 4 Click

5V 3.3V SPI I2C

UART GPIO PWM AN

An advanced air quality sensing device that combines multiple metal-oxide sensing elements on a chip.

MSRP – \$32⁰⁰
MIKROE-2896

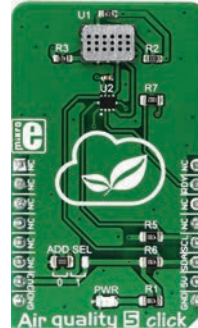

Air quality 5 Click

5V 3.3V SPI I2C

UART GPIO PWM AN

MiCS-6814, a compact triple MOS sensor from SGX Sensortech, with three fully independent sensors.

MSRP – \$45⁰⁰
MIKROE-3056



Hydrogen Click

5V 3.3V SPI I2C

UART GPIO PWM AN

It carries MQ-8 sensor for hydrogen [H2]. Sensor's detection range 100-10000ppm of H2.

MSRP – \$15⁰⁰
MIKROE-1629

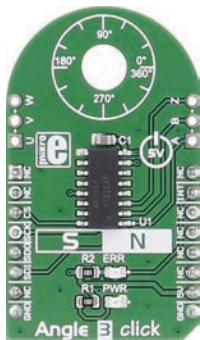

Angle 3 Click

5V 3.3V SPI I2C
UART GPIO PWM AN

With AK7451, a magnetic rotational angle sensor with 12-bit angle resolution.

MSRP – \$18⁰⁰
MIKROE-2755

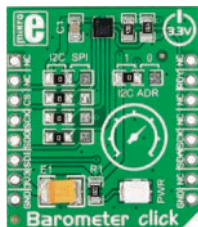

BAROMETER Click

5V 3.3V SPI I2C
UART GPIO PWM AN

LPS25HB IC, piezoresistive absolute pressure sensor. Range 260-1260 hPa.

MSRP – \$15⁰⁰
MIKROE-1817

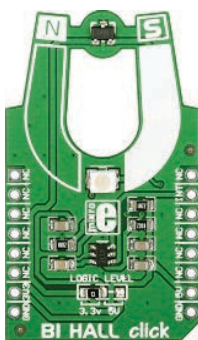

Bi Hall Click

5V 3.3V SPI I2C
UART GPIO PWM AN

US2882 bipolar Hall-effect switch and a 74LVC1T45 single bit, dual supply transceiver.

MSRP – \$12⁰⁰
MIKROE-1646

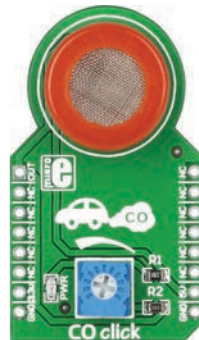

CO Click

5V 3.3V SPI I2C
UART GPIO PWM AN

MQ-7 gas sensor with high sensitivity to carbon monoxide. Detection range 20ppm-2000ppm.

MSRP – \$16⁵⁰
MIKROE-1626

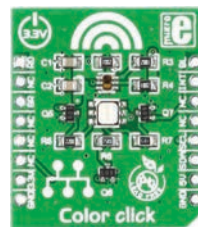

Color Click

5V 3.3V SPI I2C
UART GPIO PWM AN

With TCS3471 [RGBC] color light sensor and a RGB LED diode. Resolution up to 16-bits.

MSRP – \$15⁰⁰
MIKROE-1438



Color 2 Click

5V 3.3V SPI I2C

UART GPIO PWM AN

ISL29125 RGB color light sensor. 16-bit resolution data, measuring range 5.7 mlux-10,000 lux.

MSRP – \$16⁰⁰
MIKROE-1988

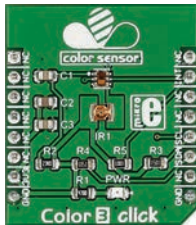

Color 3 Click

5V 3.3V SPI I2C

UART GPIO PWM AN

With TCS3771 color sensor and a narrow beam Infrared LED.

MSRP – \$17⁰⁰
MIKROE-2103

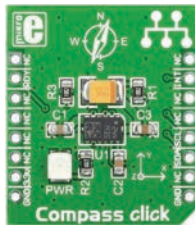

Compass Click

5V 3.3V SPI I2C

UART GPIO PWM AN

It features LSM303DLHC ultra compact high performance e-compass module.

MSRP – \$25⁰⁰
MIKROE-1386

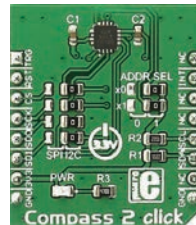

Compass 2 Click

5V 3.3V SPI I2C

UART GPIO PWM AN

With AK8963 3-axis electronic compass based on the Hall effect. 14-/16-bit selectable resolution.

MSRP – \$25⁰⁰
MIKROE-2264

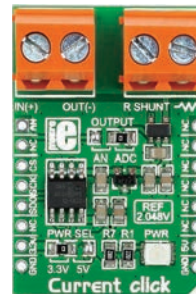

Current Click

5V 3.3V SPI I2C

UART GPIO PWM AN

With INA196 current shunt monitor, MCP3201 12-bit ADC, MAX6106 voltage reference.

MSRP – \$24⁰⁰
MIKROE-1396

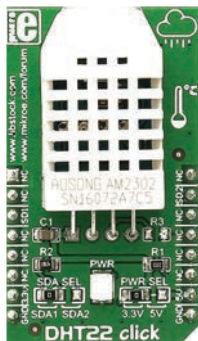

DHT22 Click

5V 3.3V SPI I2C
UART GPIO PWM AN

With DHT22 temp. and humidity measurement sensor. Hum. 0-100%, temp. -40 to +80° C.

MSRP - \$24⁰⁰
MIKROE-1798



Diff pressure Click

5V 3.3V SPI I2C
UART GPIO PWM AN

MPX5010DP pressure sensor. Designed for comparing 2 pressure measurements.

MSRP - \$59⁰⁰
MIKROE-2387

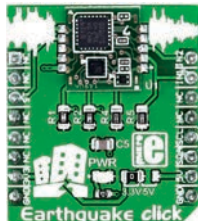

Earthquake Click

5V 3.3V SPI I2C
UART GPIO PWM AN

It carries D7S, the world's smallest high-precision seismic sensor from Omron.

MSRP - \$69⁰⁰
MIKROE-2561

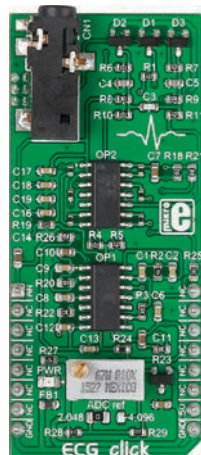

ECG Click

5V 3.3V SPI I2C
UART GPIO PWM AN

It measures the electrical activity of a beating heart through electrodes taped to the skin.

MSRP - \$39⁰⁰
MIKROE-2455



ECG 2 Click

5V 3.3V SPI I2C
UART GPIO PWM AN

Tracks the patterns of your beating heart. It carries ADS1194 16-bit delta-sigma ADC.

MSRP - \$49⁰⁰
MIKROE-2507

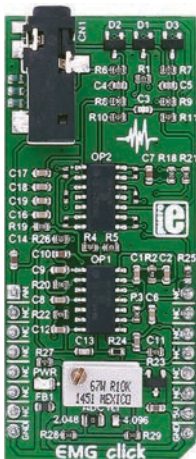

EMG Click

5V | 3.3V | SPI | I2C
 UART | GPIO | PWM | AN

Measures the electrical activity produced by the skeletal muscles.

MSRP – \$29⁰⁰
 MIKROE-2621

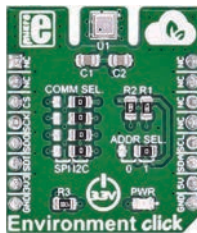

Environment Click

5V | 3.3V | SPI | I2C
 UART | GPIO | PWM | AN

Measures temperature, relative humidity, pressure and Volatile Organic compounds gases.

MSRP – \$34⁰⁰
 MIKROE-2467

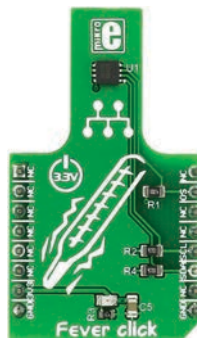

Fever Click

5V | 3.3V | SPI | I2C
 UART | GPIO | PWM | AN

Measures body temperature with MAX30205 sensor. Accuracy 0.1°C [37°C to 39°C].

MSRP – \$11⁰⁰
 MIKROE-2554

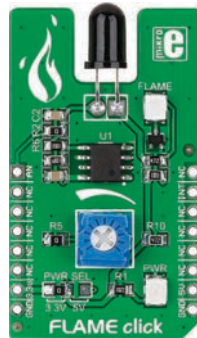

FLAME Click

5V | 3.3V | SPI | I2C
 UART | GPIO | PWM | AN

Used for fire detection. Carries PT334-6B silicon phototransistor sensitive only to infrared light.

MSRP – \$12⁰⁰
 MIKROE-1820

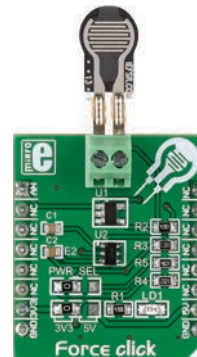

Force Click

5V | 3.3V | SPI | I2C
 UART | GPIO | PWM | AN

With Interlink Electronics' Force Sensing Resistors. Force sensitivity range 0.2N-20N.

MSRP – \$25⁰⁰
 MIKROE-2065

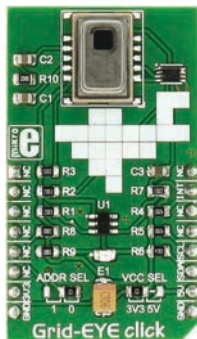

Grid-EYE Click

5V 3.3V SPI I2C

UART GPIO PWM AN

8x8 thermal array sensor-detector that carries AMG8853 infrared array sensor.

MSRP – \$79⁰⁰
MIKROE-2539

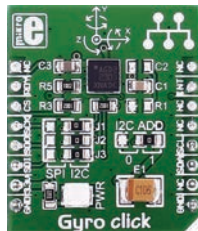

GYRO Click

5V 3.3V SPI I2C

UART GPIO PWM AN

L3GD20 3-axis digital gyroscope module - can measure angular rate and ambient temperature.

MSRP – \$25⁰⁰
MIKROE-1379

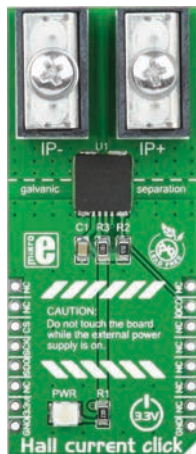

Hall current Click

5V 3.3V SPI I2C

UART GPIO PWM AN

High precision current sensor with TLI4970-D050T4, a magnetic current sensor.

MSRP – \$34⁰⁰
MIKROE-1578

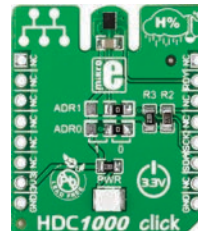

HDC1000 Click

5V 3.3V SPI I2C

UART GPIO PWM AN

It's a humidity [and temperature] measurement Click carrying the HDC1000 sensor.

MSRP – \$19⁰⁰
MIKROE-1797

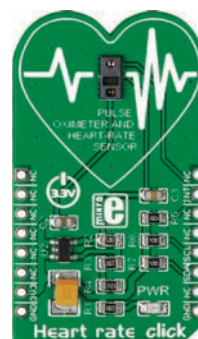

Heart rate Click

5V 3.3V SPI I2C

UART GPIO PWM AN

With Maxim's MAX30100 integrated pulse oximetry and heart-rate sensor.

MSRP – \$19⁰⁰
MIKROE-2000

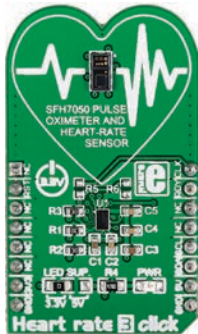

Heart rate 3 Click

5V | 3.3V | SPI | I2C

UART | GPIO | PWM | AN

SFH7050 pulse oximetry and heart rate monitoring module, and AFE4404 IC for bio-sensing.

MSRP – \$39⁰⁰
MIKROE-2036

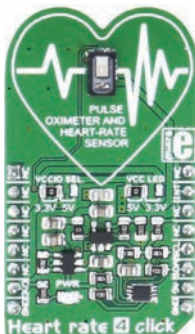

Heart rate 4 Click

5V | 3.3V | SPI | I2C

UART | GPIO | PWM | AN

Carries the MAX30101 high-sensitivity pulse oximeter and heart-rate sensor.

MSRP – \$21⁰⁰
MIKROE-2510

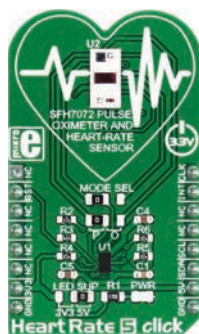

Heart Rate 5 Click

5V | 3.3V | SPI | I2C

UART | GPIO | PWM | AN

Uses the top-of-the-class integrated BIOFY[®] SFH 7072 sensor from OSRAM.

MSRP – \$32⁰⁰
MIKROE-3012



Heart Rate 7 Click

5V | 3.3V | SPI | I2C

UART | GPIO | PWM | AN

The VEMD8080 photo-sensor. A high-speed PD element, with sensitivity in the visible light spectrum.

MSRP – \$23⁰⁰
MIKROE-2998

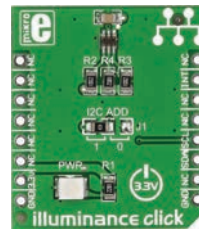

Illuminance Click

5V | 3.3V | SPI | I2C

UART | GPIO | PWM | AN

With TSL2561 light-to-digital converter. Two photodiodes: full-spectrum and infrared light.

MSRP – \$16⁰⁰
MIKROE-1688

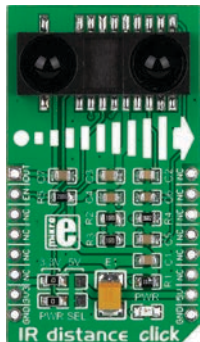

IR distance Click

5V | 3.3V | SPI | I2C
 UART | GPIO | PWM | AN

With GP2Y0A60SZ0F distance measuring sensor. Measuring range 10-150 cm.

MSRP – \$25⁰⁰
 MIKROE-1991

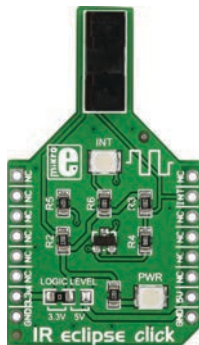

IR eclipse Click

5V | 3.3V | SPI | I2C
 UART | GPIO | PWM | AN

With EE-SX198 photo interrupter sensor - detects anything that obstructs its beam.

MSRP – \$15⁰⁰
 MIKROE-1711

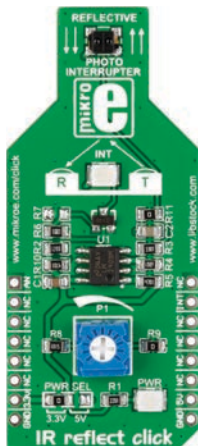

IR reflect Click

5V | 3.3V | SPI | I2C
 UART | GPIO | PWM | AN

Carries GP2S700HCP reflective photo interrupter and an onboard potentiometer.

MSRP – \$12⁰⁰
 MIKROE-1882

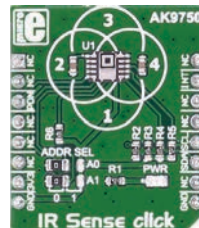

IR Sense Click

5V | 3.3V | SPI | I2C
 UART | GPIO | PWM | AN

With AK9750 quantum-type IR sensor. Detects the temperature of objects and people in motion.

MSRP – \$27⁰⁰
 MIKROE-2677

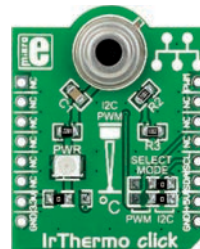

IrThermo Click 3.3V

5V | 3.3V | SPI | I2C
 UART | GPIO | PWM | AN

With MLX90614ESF-BAA IR thermometer module, factory calibrated in wide temperature range.

MSRP – \$29⁰⁰
 MIKROE-1361

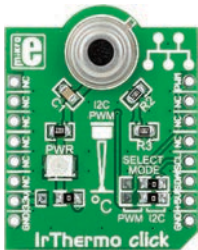

IrThermo Click 5V

5V | 3.3V | SPI | I2C

UART | GPIO | PWM | AN

With MLX90614ESF-AAA IR thermometer module, factory calibrated in wide temperature range.

MSRP – \$29⁰⁰
MIKROE-1362

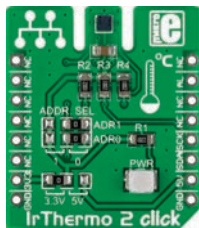

IrThermo 2 Click

5V | 3.3V | SPI | I2C

UART | GPIO | PWM | AN

It is a non-contact temperature measurement solution, with an infrared thermopile sensor.

MSRP – \$20⁰⁰
MIKROE-1888

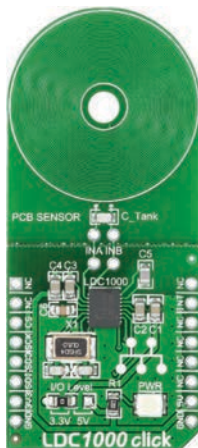

LDC1000 Click

5V | 3.3V | SPI | I2C

UART | GPIO | PWM | AN

With inductance-to-digital converter IC and a detachable sensor. For short range inductive sensing.

MSRP – \$35⁰⁰
MIKROE-1583

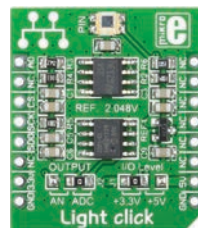

Light Click

5V | 3.3V | SPI | I2C

UART | GPIO | PWM | AN

Used to measure ambient light intensity, with PD15-22CTR8 PIN photodiode.

MSRP – \$18⁰⁰
MIKROE-1424

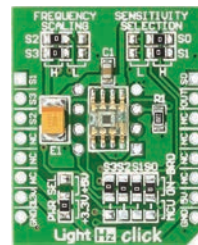

LightHz Click

5V | 3.3V | SPI | I2C

UART | GPIO | PWM | AN

With TSL230BR converter for conversion of light intensity to frequency with no external components.

MSRP – \$17⁹⁰
MIKROE-990

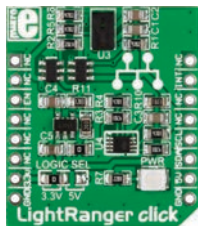

LightRanger Click

5V 3.3V SPI I2C

UART GPIO PWM AN

It's a proximity sensor carrying VL6180X IC. Also works as an ambient light sensor.

MSRP – \$24⁰⁰
MIKROE-1897

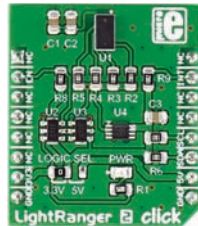

LightRanger 2 Click

5V 3.3V SPI I2C

UART GPIO PWM AN

With VL53L0X IC, the world's smallest Time-of-Flight ranging and gesture detector sensor.

MSRP – \$24⁰⁰
MIKROE-2509

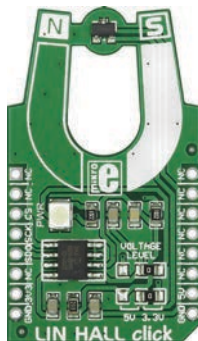

LIN HALL Click

5V 3.3V SPI I2C

UART GPIO PWM AN

Carries MLX90242 linear Hall sensor IC. Measures magnet's strength and distance.

MSRP – \$17⁰⁰
MIKROE-1648

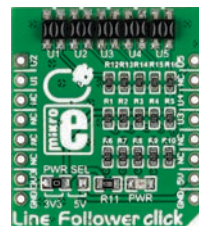

Line Follower Click

5V 3.3V SPI I2C

UART GPIO PWM AN

With five QRE1113 miniature reflective object sensors. Used for line following robots and cars.

MSRP – \$15⁰⁰
MIKROE-1999

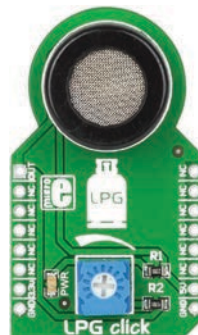

LPG Click

5V 3.3V SPI I2C

UART GPIO PWM AN

With MQ-5 sensor for detecting liquefied petroleum gas leakage. Detection range 200-10000 ppm.

MSRP – \$15⁰⁰
MIKROE-1587

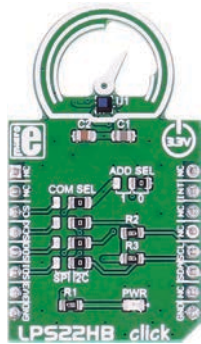

LPS22HB Click

5V | 3.3V | SPI | I2C

UART | GPIO | PWM | AN

Used as a digital barometer. It carries the LPS22HB MEMS nano pressure sensor.

MSRP – \$15⁰⁰
MIKROE-2665

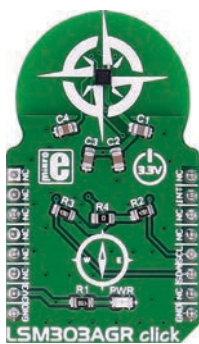

LSM303AGR Click

5V | 3.3V | SPI | I2C

UART | GPIO | PWM | AN

Measures acceleration and magnetic field characteristics. Carries LSM303AGR module.

MSRP – \$18⁰⁰
MIKROE-2684

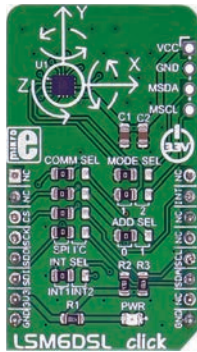

LSM6DSL Click

5V | 3.3V | SPI | I2C

UART | GPIO | PWM | AN

Measures linear and angular velocity with six degrees of freedom. Carries LSM6DSL module.

MSRP – \$15⁰⁰
MIKROE-2731

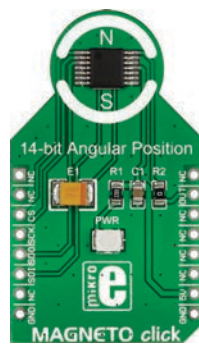

MAGNETO Click

5V | 3.3V | SPI | I2C

UART | GPIO | PWM | AN

Carries AS5048A contactless magnetic angle position sensor that relies on the Hall Effect.

MSRP – \$36⁰⁰
MIKROE-1886

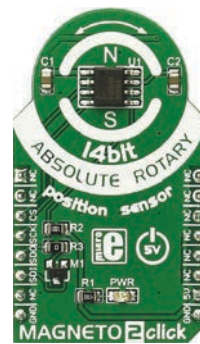

MAGNETO 2 Click

5V | 3.3V | SPI | I2C

UART | GPIO | PWM | AN

Enables the design of non-contacting rotary position sensors with MLX90316 sensor IC.

MSRP – \$29⁰⁰
MIKROE-1938



Manometer Click

5V | 3.3V | SPI | I2C
 UART | GPIO | PWM | AN

Carries a piezoresistive silicon pressure sensor with extremely high accuracy [$\pm 0.25\%$ FSS BFSL].

MSRP – \$79⁰⁰
 MIKROE-2237

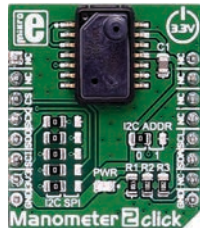

Manometer 2 Click

5V | 3.3V | SPI | I2C
 UART | GPIO | PWM | AN

With MS5525D-S0-SB001GS digital pressure sensor. 24-bit digital pressure and temp. value.

MSRP – \$39⁰⁰
 MIKROE-2550

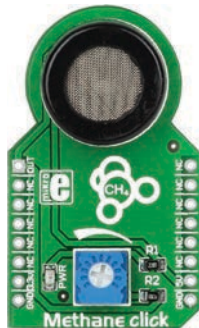

Methane Click

5V | 3.3V | SPI | I2C
 UART | GPIO | PWM | AN

With MQ-4 sensor for methane [CH₄]. Detection range 200-10000ppm of CH₄.

MSRP – \$15⁰⁰
 MIKROE-1628



MOTION Click

5V | 3.3V | SPI | I2C
 UART | GPIO | PWM | AN

It's a motion detector sensitive only to live bodies with PIR500B, a pyroelectric sensor.

MSRP – \$13⁰⁰
 MIKROE-1589

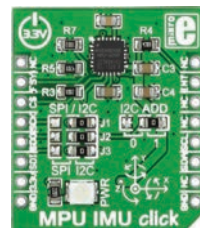

MPU IMU Click

5V | 3.3V | SPI | I2C
 UART | GPIO | PWM | AN

Carries MPU-6000 integrated 6-axis motion tracking device and a DMP [Digital Motion Processor].

MSRP – \$39⁰⁰
 MIKROE-1577



Spectral Click

5V | 3.3V | SPI | I2C

UART | GPIO | PWM | AN

Uses the AS7261, an XYZ chromatic white color sensor + NIR with electronic shutter and smart interface.

MSRP - \$26⁰⁰
MIKROE-2972



Spectral 2 Click

5V | 3.3V | SPI | I2C

UART | GPIO | PWM | AN

Uses the AS7262, 6 channel visible spectral_ID device with electronic shutter and smart Interface.

MSRP - \$26⁰⁰
MIKROE-2973



Spectral 3 Click

5V | 3.3V | SPI | I2C

UART | GPIO | PWM | AN

Uses the AS7263, a 6 channel NIR Spectral_ID device with electronic shutter and smart Interface.

MSRP - \$26⁰⁰
MIKROE-2961



IR Sense 2 Click

5V | 3.3V | SPI | I2C

UART | GPIO | PWM | AN

Uses the AK9752, an ultra-small infrared sensor IC, with an I2C interface, from AKM.

MSRP - \$21⁰⁰
MIKROE-2966

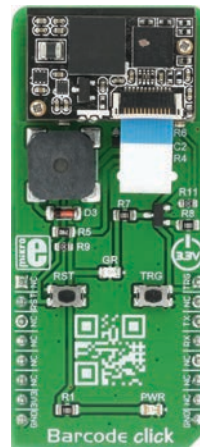

Barcode Click

5V | 3.3V | SPI | I2C

UART | GPIO | PWM | AN

The LV3296, a compact integrated barcode scanner from Rakinda company.

MSRP - \$179⁰⁰
MIKROE-2913

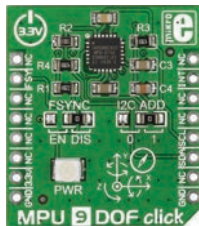

MPU 9DOF Click

5V | 3.3V | SPI | I2C
 UART | GPIO | PWM | AN

Carries the MPU-9150 system in package, the world's first 9-axis motion tracking device.

MSRP – \$42⁰⁰
 MIKROE-1719



Ozone 2 Click

5V | 3.3V | SPI | I2C
 UART | GPIO | PWM | AN

With MQ131 sensor for Ozone [O3]. Detection range 10-1000 ppm of O3.

MSRP – \$37⁰⁰
 MIKROE-2767



Pollution Click

5V | 3.3V | SPI | I2C
 UART | GPIO | PWM | AN

Detects organic gases - formaldehyde, benzene, alcohol, toluene, etc. Detection range 1x50ppm.

MSRP – \$49⁰⁰
 MIKROE-2516

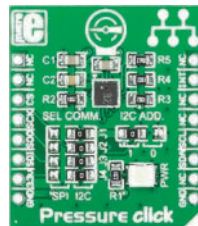

Pressure Click

5V | 3.3V | SPI | I2C
 UART | GPIO | PWM | AN

With LPS331AP digital output pressure sensor. For pressure [260-1260 mbar] and temp. [-40°C to 80°C].

MSRP – \$25⁰⁰
 MIKROE-1422

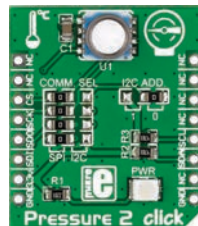

Pressure 2 Click

5V | 3.3V | SPI | I2C
 UART | GPIO | PWM | AN

With MS5803, a high resolution MEMS pressure sensor. Range 0-14 bars, resolution up to 0.2 mbars.

MSRP – \$69⁰⁰
 MIKROE-1880

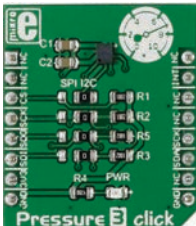

Pressure 3 Click

5V | 3.3V | SPI | I2C
 UART | GPIO | PWM | AN

With DPS310 digital barometric pressure sensor. Range 300-1200 hPa.

MSRP – \$20⁰⁰
 MIKROE-2293

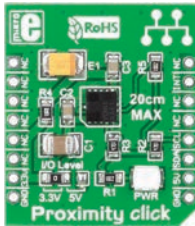

Proximity Click

5V | 3.3V | SPI | I2C
 UART | GPIO | PWM | AN

With VCNL4010 proximity and ambient light sensor. Range up to 20cm, 16-bit resolution.

MSRP – \$17⁰⁰
 MIKROE-1445

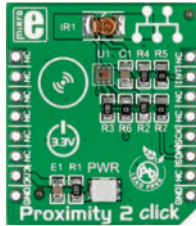

Proximity 2 Click

5V | 3.3V | SPI | I2C
 UART | GPIO | PWM | AN

With MAX44000, an IC that integrates an ambient light and a proximity sensor. Range 0.03-65.535 lux.

MSRP – \$19⁰⁰
 MIKROE-1818

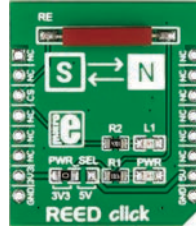

REED Click

5V | 3.3V | SPI | I2C
 UART | GPIO | PWM | AN

With a standard reed switch. Used in mechanical systems as proximity sensors.

MSRP – \$7⁰⁰
 MIKROE-1998

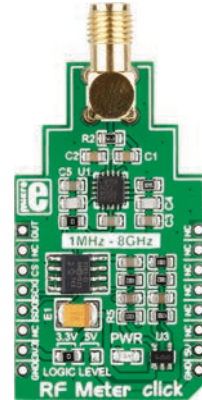

RF Meter Click

5V | 3.3V | SPI | I2C
 UART | GPIO | PWM | AN

It's an RF power measurement device. Frequency span 1 MHz-8 GHz, over 60 dB range.

MSRP – \$44⁰⁰
 MIKROE-2034

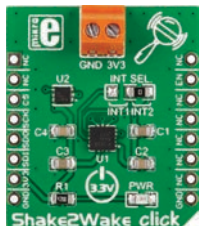

Shake2Wake Click

5V 3.3V SPI I2C
 UART GPIO PWM AN

With ADXL362 ultralow power, 3-axis MEMS accelerometer. Includes several activity detection modes.

MSRP – \$39⁰⁰
 MIKROE-1942

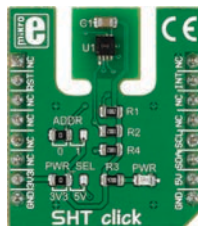

SHT Click

5V 3.3V SPI I2C
 UART GPIO PWM AN

Temperature and humidity sensor SHT3x-DIS. -0 to 100% RH, 40 to 125°C temp. range.

MSRP – \$26⁰⁰
 MIKROE-2101

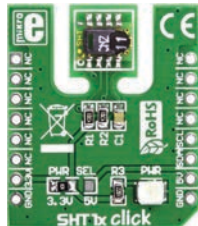

SHT1x Click

5V 3.3V SPI I2C
 UART GPIO PWM AN

Digital humidity and temperature sensor SHT11. Not recommended for newer designs.

MSRP – \$13⁰⁰
 MIKROE-949



Smoke Click

5V 3.3V SPI I2C
 UART GPIO PWM AN

With MAX30105 optical sensor for smoke detection. Sensor's inherent resolution 0.0625°C.

MSRP – \$19⁰⁰
 MIKROE-2560



Stretch Click

5V 3.3V SPI I2C
 UART GPIO PWM AN

Measures stretch forces with conductive rubber cord - 40-160 ohms per cm resistance.

MSRP – \$35⁰⁰
 MIKROE-2064

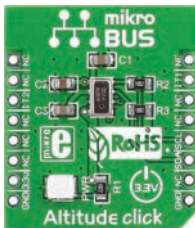

Altitude Click

5V | 3.3V | SPI | I2C
 UART | GPIO | PWM | AN

MEMS pressure sensor MPL3115A2. Pressure/altitude [20-bit] and temp. [12-bit] data.

MSRP – \$14⁰⁰
 MIKROE-1489



THERMO Click

5V | 3.3V | SPI | I2C
 UART | GPIO | PWM | AN

With MAX31855K thermocouple-to-digital converter and PCC-SMP K-type thermocouple connector.

MSRP – \$29⁰⁰
 MIKROE-1197

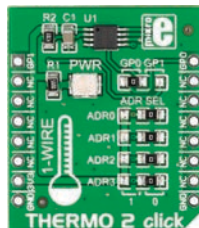

THERMO 2 Click

5V | 3.3V | SPI | I2C
 UART | GPIO | PWM | AN

With DS18B25, a digital thermometer IC with a unique 64-bit address. -10°C to 85°C, ±0.5°C accuracy.

MSRP – \$15⁰⁰
 MIKROE-1840

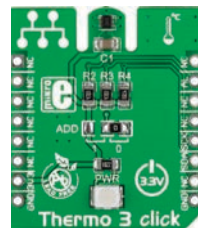

Thermo 3 Click

5V | 3.3V | SPI | I2C
 UART | GPIO | PWM | AN

With TMP102, a digital temp. sensor IC. Accurate within 0.5°C. Range from -25°C to 85°C.

MSRP – \$9⁰⁰
 MIKROE-1885

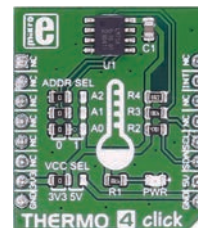

THERMO 4 Click

5V | 3.3V | SPI | I2C
 UART | GPIO | PWM | AN

It carries digital temperature sensor and thermal watchdog. Range from -55 °C to +125 °C.

MSRP – \$9⁰⁰
 MIKROE-2632

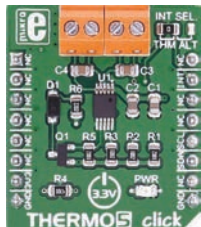

THERMO 5 Click

5V | 3.3V | SPI | I2C

UART | GPIO | PWM | AN

Measures temperature in default range of 0°C to 127°C and extended range of -64°C to 191°C.

MSRP – \$11⁰⁰
MIKROE-2571

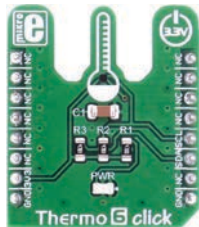

Thermo 6 Click

5V | 3.3V | SPI | I2C

UART | GPIO | PWM | AN

Ambient temp. measurement device, based on the MAX31875 temp. sensor.

MSRP – \$9⁰⁰
MIKROE-2769



THERMO K Click

5V | 3.3V | SPI | I2C

UART | GPIO | PWM | AN

It carries the MCP9600 IC. It can measure temperatures from -200 °C to +1372 °C.

MSRP – \$24⁰⁰
MIKROE-2501



Thermostat Click

5V | 3.3V | SPI | I2C

UART | GPIO | PWM | AN

It carries MAX7502 IC that can measure temp. from -25°C to +100°C. Accuracy ±1.5°C.

MSRP – \$19⁰⁰
MIKROE-2273

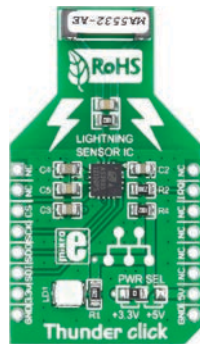

Thunder Click

5V | 3.3V | SPI | I2C

UART | GPIO | PWM | AN

Detects the presence and proximity of lightning activity with AS3935 lightning sensor.

MSRP – \$35⁰⁰
MIKROE-1444

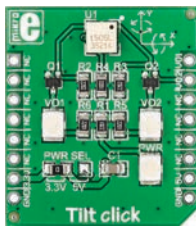

Tilt Click

5V | 3.3V | SPI | I2C

UART | GPIO | PWM | AN

With RPI-1035, a 4-directional optical tilt sensor - left, right, backward, forward movement.

MSRP - \$12⁰⁰
MIKROE-1834

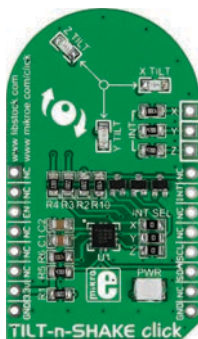

TILTnSHAKE Click

5V | 3.3V | SPI | I2C

UART | GPIO | PWM | AN

With MMA8491Q IC, a 3-axis digital accelerometer. Can function as a 45 ° tilt sensor.

MSRP - \$19⁰⁰
MIKROE-1853

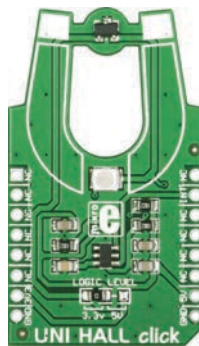

UNI HALL Click

5V | 3.3V | SPI | I2C

UART | GPIO | PWM | AN

With US5881 unipolar Hall-effect switch sensitive to the North Pole magnetic fields.

MSRP - \$12⁰⁰
MIKROE-1647

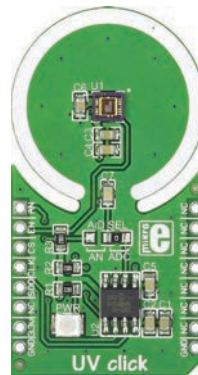

UV Click

5V | 3.3V | SPI | I2C

UART | GPIO | PWM | AN

With ML8511 IC that is sensitive to UVA and UVB rays. Outputs either analog or digital signals.

MSRP - \$24⁰⁰
MIKROE-1677

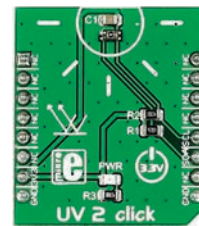

UV 2 Click

5V | 3.3V | SPI | I2C

UART | GPIO | PWM | AN

Carries VEML6075 UVA and UVB light sensor. With a photodiode, amplifiers, analog/digital circuits.

MSRP - \$19⁰⁰
MIKROE-2378

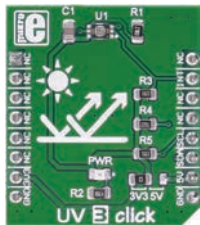

UV 3 Click

5V 3.3V SPI I2C
UART GPIO PWM AN

An advanced ultraviolet (UV) light sensor with VEML6070 UVA light sensor.

MSRP – \$9⁰⁰
MIKROE-2736

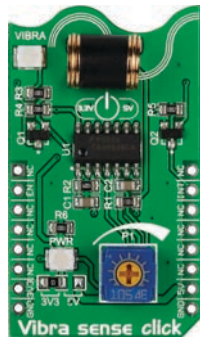

Vibra sense Click

5V 3.3V SPI I2C
UART GPIO PWM AN

A micro shock vibration sensor with a digital output. For anti-tampering, anti-theft devices.

MSRP – \$18⁰⁰
MIKROE-1927

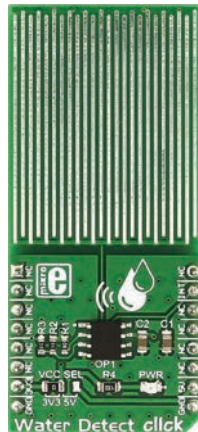

Water Detect Click

5V 3.3V SPI I2C
UART GPIO PWM AN

For detecting water and other electroconductive liquids. Carries Micro-chip's MCP606.

MSRP – \$9⁰⁰
MIKROE-2786

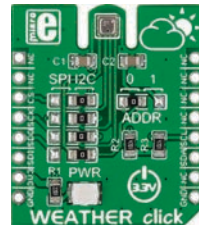

Weather Click

5V 3.3V SPI I2C
UART GPIO PWM AN

With BME280 integrated environmental unit. Detects humidity, pressure, and temperature.

MSRP – \$22⁰⁰
MIKROE-1978

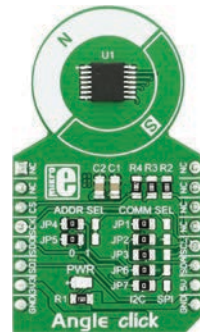

Angle Click

5V 3.3V SPI I2C
UART GPIO PWM AN

Hall-effect angle sensing device used to measure the rotational angle of the magnetic field.

MSRP – \$16⁰⁰
MIKROE-2030



Thermo J Click

5V | 3.3V | SPI | I2C

UART | GPIO | PWM | AN

It is a temperature measurement Click board™, which uses a thermo-couple type-J probe.

MSRP – \$24⁰⁰
MIKROE-2811

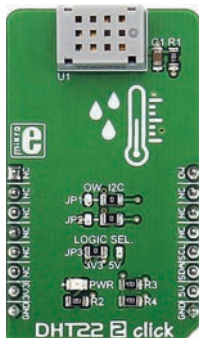

DHT22 2 Click

5V | 3.3V | SPI | I2C

UART | GPIO | PWM | AN

It is used for measuring the environmental temperature and relative humidity.

MSRP – \$22⁰⁰
MIKROE-2818



IrDA 3 Click

5V | 3.3V | SPI | I2C

UART | GPIO | PWM | AN

Intelligent IR transceiver device that sends and receives UART commands via the IR interface.

MSRP – \$26⁰⁰
MIKROE-2871

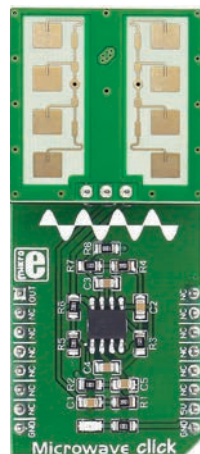

Microwave Click

5V | 3.3V | SPI | I2C

UART | GPIO | PWM | AN

It detects movement, thanks to the PD-V11 a 24GHz microwave motion sensor.

MSRP – \$25⁰⁰
MIKROE-2781



Proximity 3 Click

5V | 3.3V | SPI | I2C

UART | GPIO | PWM | AN

Intelligent proximity and light sensing device - high sensitivity long distance PS and ALS.

MSRP – \$17⁰⁰
MIKROE-2801



Alcohol Click

5V 3.3V SPI I2C
UART GPIO PWM AN

Detects alcohol in concentrations from 0.04 to 4mg/l with MQ-3 Semiconductor sensor.

MSRP – \$15⁰⁰
MIKROE-1586

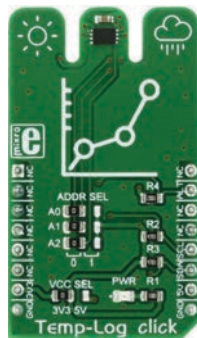

Temp-Log Click

5V 3.3V SPI I2C
UART GPIO PWM AN

A precise ambient temperature measurement device, with 8Kbit (1024 bytes) of EEPROM memory.

MSRP – \$15⁰⁰
MIKROE-2886

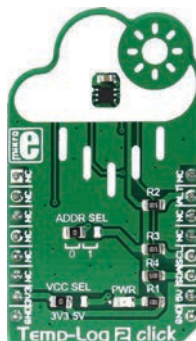

Temp-Log 2 Click

5V 3.3V SPI I2C
UART GPIO PWM AN

A precise ambient temp. measurement device, with the additional non-volatile [EEPROM] memory.

MSRP – \$15⁰⁰
MIKROE-3004



HTU21D Click

5V 3.3V SPI I2C
UART GPIO PWM AN

Carries a relative humidity sensor with temperature output. Rel. hum. 0-100%, temp. -40 to +125° C.

MSRP – \$21⁰⁰
MIKROE-1687

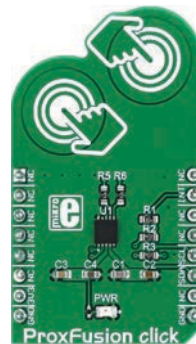

ProxFusion Click

5V 3.3V SPI I2C
UART GPIO PWM AN

A multifunctional capacitive and Hall-effect sensor device. Carries the IQS624, a combined multi-sensor IC from Azoteq.

MSRP – \$9⁰⁰
MIKROE-2920

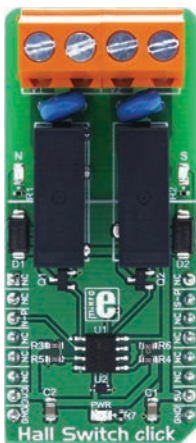

Hall Switch Click

5V 3.3V SPI I2C

UART GPIO PWM AN

Uses the AH1389, an ultra-sensitive dual output unipolar Hall Effect switch, from Diodes Incorporated.

MSRP - \$18⁰⁰
MIKROE-2985

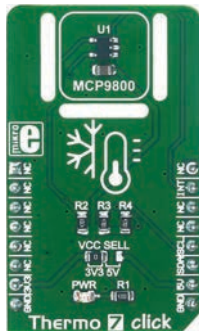

Thermo 7 Click

5V 3.3V SPI I2C

UART GPIO PWM AN

Uses the MCP9800, a high accuracy temperature sensor IC with the 2-Wire interface, from Microchip.

MSRP - \$9⁰⁰
MIKROE-2979



Proximity 5 Click

5V 3.3V SPI I2C

UART GPIO PWM AN

Features the VCN-L4035X01 J, a fully integrated proximity and ambient light sensor.

MSRP - \$15⁰⁰
MIKROE-2984

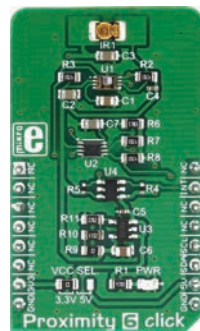

Proximity 6 Click

5V 3.3V SPI I2C

UART GPIO PWM AN

Uses the ADUX1020, a photometric sensor for gesture and proximity detection.

MSRP - \$29⁰⁰
MIKROE-3048



Hall current 2 Click

5V 3.3V SPI I2C

UART GPIO PWM AN

A Hall effect linear current sensor with over-current fault output for less than 100 V Isolation Applications.

MSRP - \$18⁰⁰
MIKROE-2987

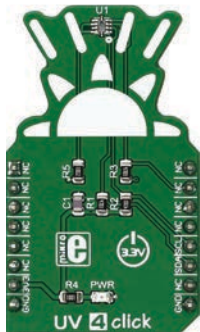

UV 4 Click

5V 3.3V SPI I2C
UART GPIO PWM AN

Equipped with the SI1133, a UV index and ambient light sensor with I2C Interface, from Silicon Labs.

MSRP – \$15⁰⁰
MIKROE-2989

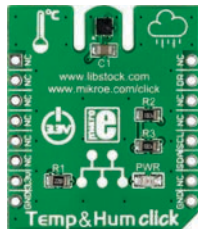

Temp&Hum Click

5V 3.3V SPI I2C
UART GPIO PWM AN

With HTS221 temp. and relative humidity sensor. Measurement accuracy is $\pm 1^\circ\text{C}$ in $0\text{--}60^\circ\text{C}$ range.

MSRP – \$16⁰⁰
MIKROE-1971

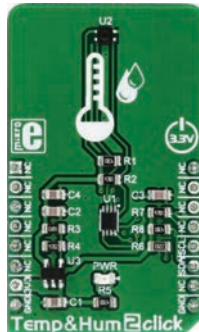

Temp&Hum 2 Click

5V 3.3V SPI I2C
UART GPIO PWM AN

Uses the SI7034, a digital humidity and temperature sensor IC with I2C interface, from Silicon Labs.

MSRP – \$16⁰⁰
MIKROE-3085

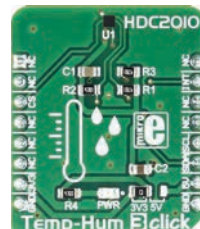

Temp-Hum 3 Click

5V 3.3V SPI I2C
UART GPIO PWM AN

Uses the HDC2010, a Low Power Humidity and Temperature Digital Sensor from Texas Instruments.

MSRP – \$13⁰⁰
MIKROE-2937

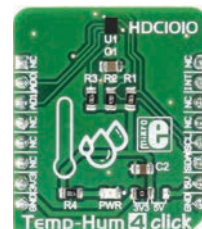

Temp-Hum 4 Click

5V 3.3V SPI I2C
UART GPIO PWM AN

A smart environmental temp. and humidity sensor, uses HDC1010 sensor from Texas Instruments.

MSRP – \$13⁰⁰
MIKROE-2938

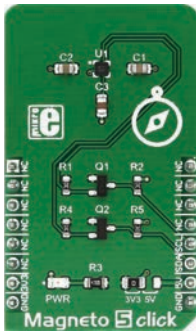

Magneto 5 Click

5V | 3.3V | SPI | I2C

UART | GPIO | PWM | AN

Features the MEMSIC MMC34160PJ, a 3-axis magnetic sensor IC.

MSRP – \$15⁰⁰
MIKROE-3050

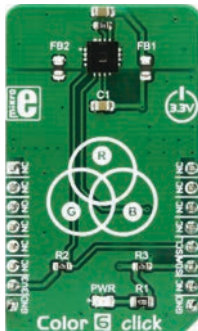

Color 6 Click

5V | 3.3V | SPI | I2C

UART | GPIO | PWM | AN

Features the AS73211, an XYZ true color sensor from AMS.

MSRP – \$32⁰⁰
MIKROE-3061

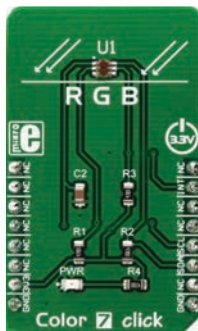

Color 7 Click

5V | 3.3V | SPI | I2C

UART | GPIO | PWM | AN

Features the TCS3472 color light to digital converter with IR filter, from AMS.

MSRP – \$16⁰⁰
MIKROE-3062



Ambient Click

5V | 3.3V | SPI | I2C

UART | GPIO | PWM | AN

With MLX75305 IC, CMOS integrated optical sensor. Converts ambient light intensity into voltage.

MSRP – \$9⁰⁰
MIKROE-1890

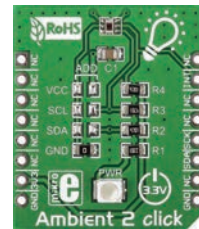

Ambient 2 Click

5V | 3.3V | SPI | I2C

UART | GPIO | PWM | AN

TI's OPT3001 ambient light sensor. Measures the visible part of the light spectrum.

MSRP – \$14⁰⁰
MIKROE-1903

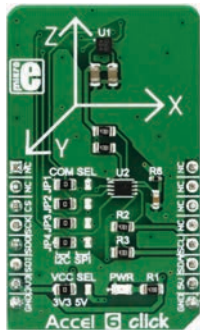

Accel 6 Click

5V | 3.3V | SPI | I2C

UART | GPIO | PWM | AN

The BMA280, a 14bit triaxial acceleration sensor with intelligent on-chip motion triggered interrupt controller.

MSRP – \$17⁰⁰
MIKROE-3075

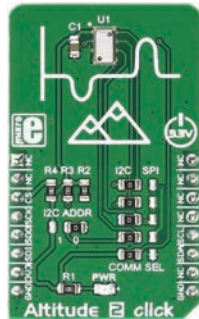

Altitude 2 Click

5V | 3.3V | SPI | I2C

UART | GPIO | PWM | AN

Uses the MS5607-02BA03, a barometric pressure sensor IC with the stainless steel cap.

MSRP – \$15⁰⁰
MIKROE-3030

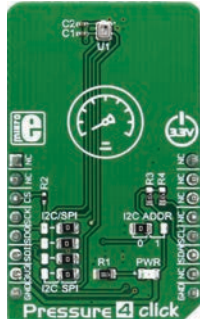

Pressure 4 Click

5V | 3.3V | SPI | I2C

UART | GPIO | PWM | AN

Features the BMP280, a digital pressure sensor, from Bosch Sensortech.

MSRP – \$18⁰⁰
MIKROE-3020

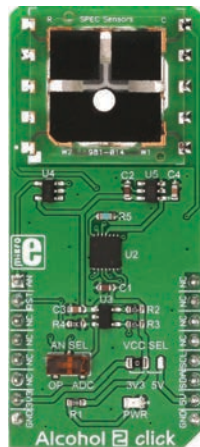

Alcohol 2 Click

5V | 3.3V | SPI | I2C

UART | GPIO | PWM | AN

The BMA280, a 14bit triaxial acceleration sensor with intelligent on-chip motion triggered interrupt controller.

MSRP – \$52⁰⁰
MIKROE-3097



NO2 Click

5V | 3.3V | SPI | I2C

UART | GPIO | PWM | AN

The 3SP-NO2-20 gas sensor from SPEC Sensors, which can sense NO2 concentration up to 20ppm.

MSRP – \$52⁰⁰
MIKROE-3098

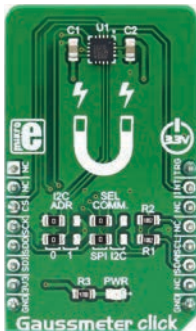

Gaussmeter Click

5V | 3.3V | SPI | I2C

UART | GPIO | PWM | AN

The MLX90393, a micro-power magnetometer based on the proprietary Triaxis® technology.

MSRP – \$19⁰⁰
MIKROE-3099



Oximeter Click

5V | 3.3V | SPI | I2C

UART | GPIO | PWM | AN

The ADPD105, a highly configurable photometric front end (AFE) device from Analog Devices.

MSRP – \$39⁰⁰
MIKROE-3102

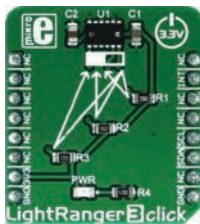

LightRanger 3 Click

5V | 3.3V | SPI | I2C

UART | GPIO | PWM | AN

Uses the Simblee™ enabled RFD77402 ToF sensor module from RF Digital.

MSRP – \$24⁰⁰
MIKROE-3103

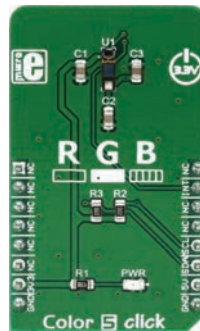

Color 5 Click

5V | 3.3V | SPI | I2C

UART | GPIO | PWM | AN

Uses the P12347-01CT, from Hamamatsu company.

MSRP – \$16⁰⁰
MIKROE-3107

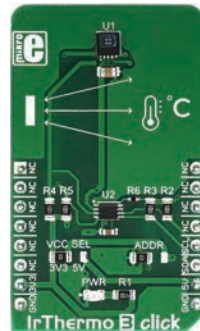

IrThermo 3 Click

5V | 3.3V | SPI | I2C

UART | GPIO | PWM | AN

Uses the MLX90632 FIR sensor from Melexis as the contactless temperature sensor.

MSRP – \$27⁰⁰
MIKROE-3121

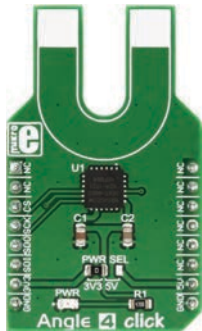

Angle 4 Click

5V 3.3V SPI I2C
UART GPIO PWM AN

With the AEAT-8800-Q24, an integrated 10 to 16-bit programmable angular magnetic encoder.

MSRP – \$26⁰⁰
MIKROE-3130

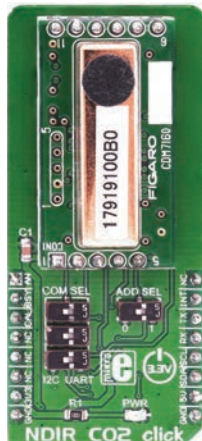

NDIR CO2 Click

5V 3.3V SPI I2C
UART GPIO PWM AN

Uses the CDM7160 integrated sensor and measures an absolute CO2 concentration.

MSRP – \$149⁰⁰
MIKROE-3134



Hall Current 3 Click

5V 3.3V SPI I2C
UART GPIO PWM AN

Uses Hall effect to provide a precise and reliable measurement of reasonably high current.

MSRP – \$19⁰⁰
MIKROE-3118

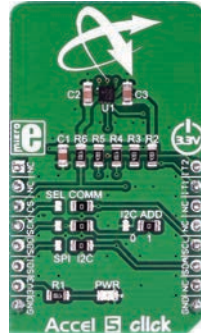

Accel 5 Click

5V 3.3V SPI I2C
UART GPIO PWM AN

Features an ultra-low power triaxial accelerometer sensor, labeled as the BMA400.

MSRP – \$19⁰⁰
MIKROE-3149

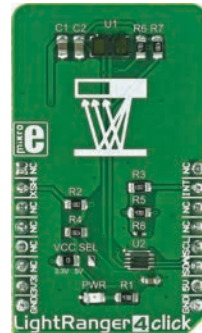

LightRanger 4 Click

5V 3.3V SPI I2C
UART GPIO PWM AN

Measures an accurate distance based on a ToF with VL53L1X rangefinder module.

MSRP – \$24⁰⁰
MIKROE-3176

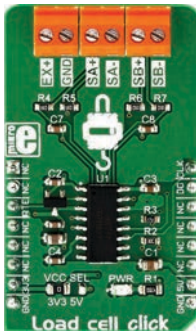

Load cell Click

5V | 3.3V | SPI | I2C

UART | GPIO | PWM | AN

With the HX711, a 24bit analog to digital converter (ADC), for weight scale applications.

MSRP – \$12⁰⁰
MIKROE-3168

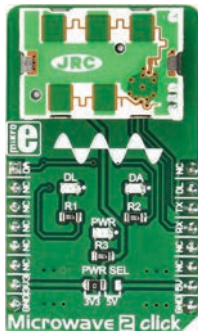

Microwave 2 Click

5V | 3.3V | SPI | I2C

UART | GPIO | PWM | AN

Detects movement by utilizing the NJR4265RF2C1, an intelligent 24GHz microwave motion sensor.

MSRP – \$55⁰⁰
MIKROE-3187

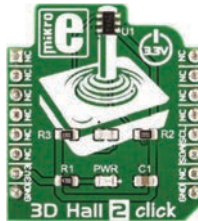

3D Hall 2 Click

5V | 3.3V | SPI | I2C

UART | GPIO | PWM | AN

Measures the magnetic field in three perpendicular axes. With the TLV493D-A1B6, a 3D magnetic sensor.

MSRP – \$15⁰⁰
MIKROE-3190

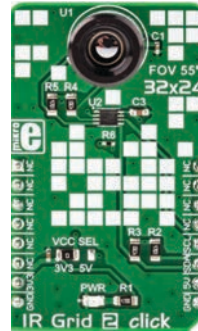

IR Grid 2 Click

5V | 3.3V | SPI | I2C

UART | GPIO | PWM | AN

It is equipped with the MLX90640, a 32x24 IR array sensor which contains 8 Kbit EEPROM.

MSRP – \$75⁰⁰
MIKROE-3194

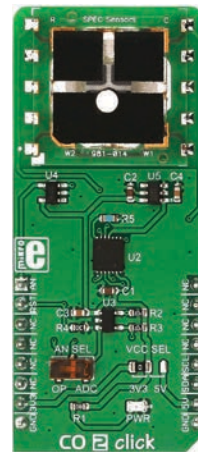

CO 2 Click

5V | 3.3V | SPI | I2C

UART | GPIO | PWM | AN

With the SPEC amperometric, 3SP CO 1000 gas sensor which electrochemically reacts with the [CO].

MSRP – \$52⁰⁰
MIKROE-3196

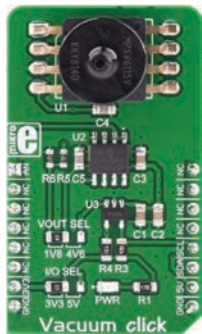

Vacuum Click

5V 3.3V SPI I2C

UART GPIO PWM AN

With the monolithic vacuum sensor the MPXV6115V, it measures pressure values down to -115kPa.

MSRP – \$43⁰⁰
MIKROE-3195

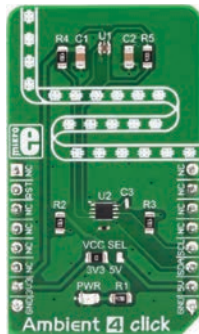

Ambient 4 Click

5V 3.3V SPI I2C

UART GPIO PWM AN

Uses the BH1721FVC, a 16-bit digital light sensor with the I2C serial interface.

MSRP – \$16⁰⁰
MIKROE-3199



3D HALL 5 Click

5V 3.3V SPI I2C

UART GPIO PWM AN

Carries the IIS2MDC-TR, a low power 3D magnetic sensor.

MSRP – \$15⁰⁰
MIKROE-3197



Color 8 Click

5V 3.3V SPI I2C

UART GPIO PWM AN

Features the ROHM's BH1749NUC, an integrated color sensor IC.

MSRP – \$15⁰⁰
MIKROE-3213

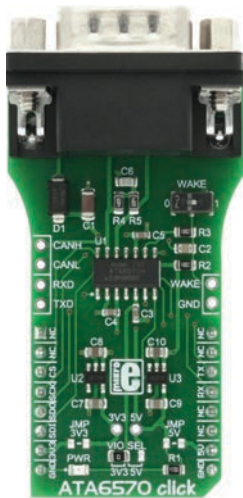

ATA6570 Click

5V | 3.3V | SPI | I2C
 UART | GPIO | PWM | AN

Uses the ATA6570, a standalone high speed CAN transceiver IC from Microchip.

MSRP – \$23⁰⁰
 MIKROE-2900

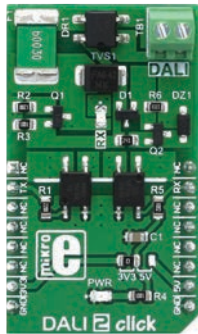

DALI 2 Click

5V | 3.3V | SPI | I2C
 UART | GPIO | PWM | AN

It is used for interfacing with the DALI network, and as a compliant with the DALI-2 physical layer requirements.

MSRP – \$25⁰⁰
 MIKROE-2672

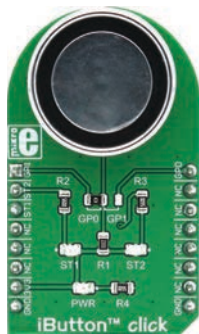

iButton™ Click

5V | 3.3V | SPI | I2C
 UART | GPIO | PWM | AN

Comes with Maxim's DS1990A, a serial number iButton™ device with a unique 64-bit serial number.

MSRP – \$35⁰⁰
 MIKROE-3045

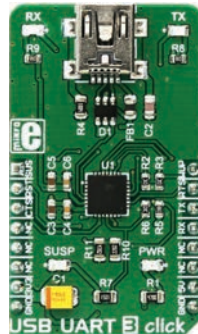

USB UART 3 Click

5V | 3.3V | SPI | I2C
 UART | GPIO | PWM | AN

The CP2102N, a highly integrated USB to UART interface, from Silicon Labs.

MSRP – \$15⁰⁰
 MIKROE-3063

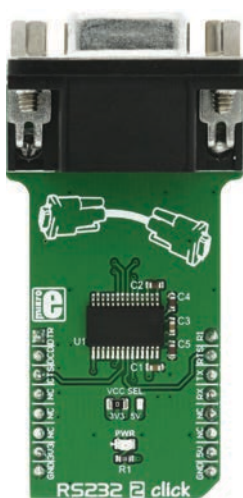

RS232 2 Click

5V | 3.3V | SPI | I2C
 UART | GPIO | PWM | AN

The MAX3237E, a 3V to 5.5V multichannel RS232, 1 Mbit/s line driver/receiver from Texas Instruments.

MSRP – \$15⁰⁰
 MIKROE-2897

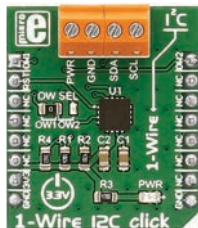

1-Wire I2C Click

5V | 3.3V | SPI | I2C
 UART | GPIO | PWM | AN

Converts I2C to 1-wire with DS28E17 1-Wire-to-I2C master bridge from Maxim Integrated.

MSRP – \$22⁰⁰
 MIKROE-2750

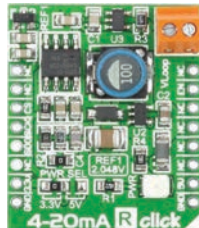

4-20 mA R Click

5V | 3.3V | SPI | I2C
 UART | GPIO | PWM | AN

Serves as a receiver in a 4-20mA current loop standard. Converts it into a voltage [0.4-2V].

MSRP – \$26⁰⁰
 MIKROE-1387

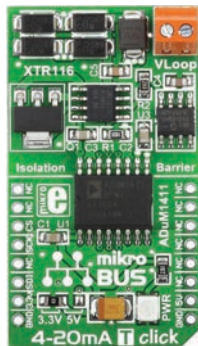

4-20 mA T Click

5V | 3.3V | SPI | I2C
 UART | GPIO | PWM | AN

Easy solution for adding 4-to-20mA industry standard communication protocol to your design.

MSRP – \$26⁰⁰
 MIKROE-1296

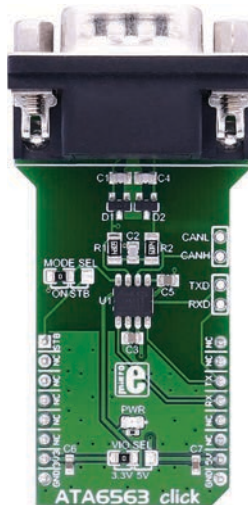

ATA6563 Click

5V | 3.3V | SPI | I2C
 UART | GPIO | PWM | AN

Microchip's ATA6563 high-speed CAN transceiver for Classical CAN and CAN FD networks.

MSRP – \$20⁰⁰
 MIKROE-2334

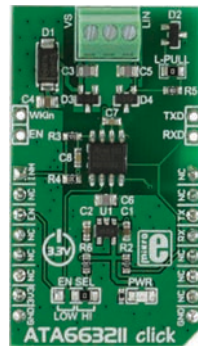

ATA663211 Click

5V | 3.3V | SPI | I2C
 UART | GPIO | PWM | AN

LIN transceiver IC designed to handle low-speed data communication in applications.

MSRP – \$19⁰⁰
 MIKROE-2335

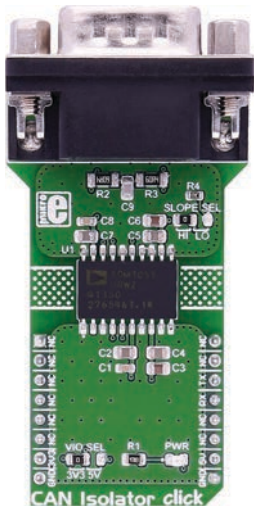

CAN Isolator Click

5V | 3.3V | SPI | I2C
 UART | GPIO | PWM | AN

Provides isolated CAN communication. Data rates of up to 1 Mbps. Carries a DB 9-pin male connector.

MSRP - \$39⁰⁰
 MIKROE-2627



CAN SPI Click 3.3V

5V | 3.3V | SPI | I2C
 UART | GPIO | PWM | AN

Adds CAN connectivity with SPI interface. Features SN65HVD230 CAN transceiver circuit.

MSRP - \$21⁰⁰
 MIKROE-986



CAN SPI Click 5V

5V | 3.3V | SPI | I2C
 UART | GPIO | PWM | AN

Adds CAN connectivity with SPI interface. With MCP2551 CAN transceiver circuit.

MSRP - \$21⁰⁰
 MIKROE-988

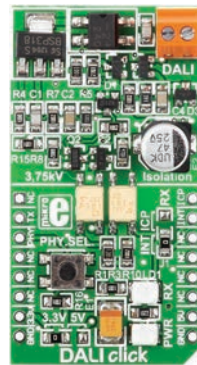

DALI Click

5V | 3.3V | SPI | I2C
 UART | GPIO | PWM | AN

Provides Digital Lighting Interface. With two optocouplers, push button, screw terminal.

MSRP - \$25⁰⁰
 MIKROE-1297



ETH Click

5V | 3.3V | SPI | I2C
 UART | GPIO | PWM | AN

With ENC28J60, a 28-pin, 10BASE-T stand-alone Ethernet controller with an on-board MAC & PHY.

MSRP - \$24⁰⁰
 MIKROE-971



ETH WIZ Click

5V | 3.3V | SPI | I2C
 UART | GPIO | PWM | AN

With W5500, a 48-pin, 10/100 BASE-TX stand-alone Ethernet controller. Standard RJ-45 connector.

MSRP – \$19⁰⁰
 MIKROE-1718



EXPAND Click

5V | 3.3V | SPI | I2C
 UART | GPIO | PWM | AN

Expands the number of input-output lines with Microchip's 16-bit I/O expander MCP23S17.

MSRP – \$12⁰⁰
 MIKROE-951

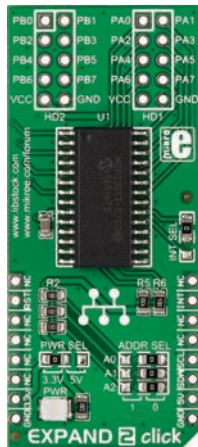

Expand 2 Click

5V | 3.3V | SPI | I2C
 UART | GPIO | PWM | AN

Expands the number of input-output lines with Microchip's 16-bit I/O expander MCP23017.

MSRP – \$12⁰⁰
 MIKROE-1838

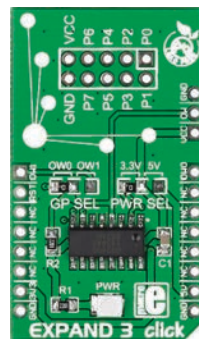

Expand 3 Click

5V | 3.3V | SPI | I2C
 UART | GPIO | PWM | AN

With DS2408, an 8-channel programmable I/O expander from Maxim Integrated.

MSRP – \$19⁰⁰
 MIKROE-1874



EXPAND 4 Click

5V | 3.3V | SPI | I2C
 UART | GPIO | PWM | AN

Port expander for high power peripherals with TPC1C6A595 power logic 8-bit register.

MSRP – \$14⁰⁰
 MIKROE-1910

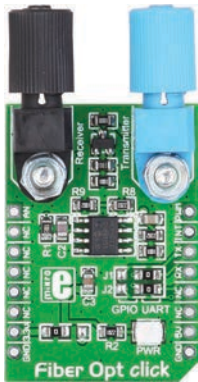

Fiber Opt Click

5V 3.3V SPI I2C
UART GPIO PWM AN

Adds fiber-optic communication with IF-D91 fiber-optic photodiode, IF-E97 fiber-optic LED diode.

MSRP – \$34⁰⁰
MIKROE-1940

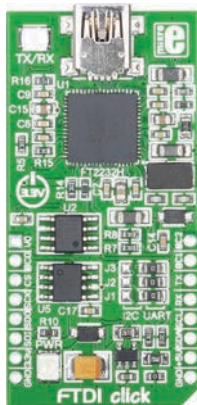

FTDI Click

5V 3.3V SPI I2C
UART GPIO PWM AN

With FT232RL - dual high speed USB 2.0 to UART/I2C/SPI serial interface converter.

MSRP – \$29⁰⁰
MIKROE-1421

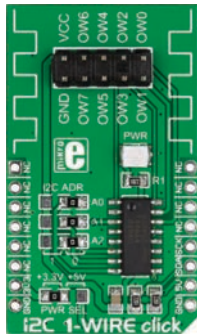

I2C 1-Wire Click

5V 3.3V SPI I2C
UART GPIO PWM AN

Performs bidirectional conversions between I2C masters and 1-Wire slave devices with DS2482-800.

MSRP – \$28⁰⁰
MIKROE-1892

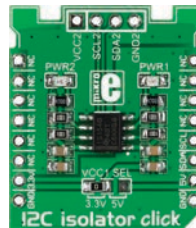

I2C Isolator Click

5V 3.3V SPI I2C
UART GPIO PWM AN

TI's ISO1540, a low-power, bidirectional isolator compatible with I2C interfaces.

MSRP – \$18⁰⁰
MIKROE-1878

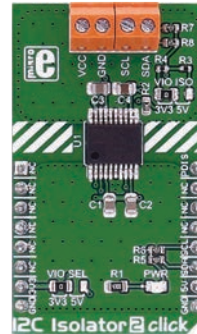

I2C Isolator 2 Click

5V 3.3V SPI I2C
UART GPIO PWM AN

Provides I2C lines and power isolation for slave devices with ADM3260 dual I2C isolator.

MSRP – \$24⁰⁰
MIKROE-2609

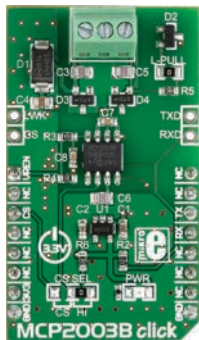

MCP2003B Click

5V | 3.3V | SPI | I2C
 UART | GPIO | PWM | AN

It's a physical interface to automotive and industrial LIN systems with a bi-directional LIN transceiver.

MSRP – \$18⁰⁰
 MIKROE-2227

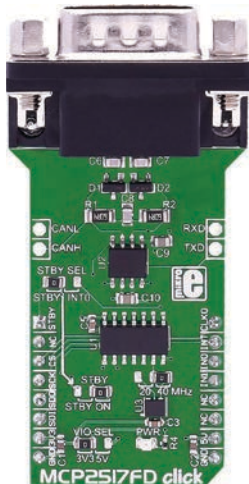

MCP2517FD Click

5V | 3.3V | SPI | I2C
 UART | GPIO | PWM | AN

With MCP2517FD CAN FD controller and ATA6563 high-speed CAN transceiver.

MSRP – \$25⁰⁰
 MIKROE-2379

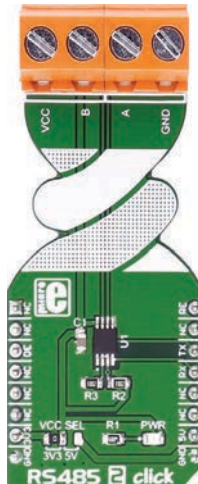

RS485 2 Click

5V | 3.3V | SPI | I2C
 UART | GPIO | PWM | AN

Carries MAX3471 half-duplex transceiver for lithium battery-powered RS-485/RS-422 applications.

MSRP – \$18⁰⁰
 MIKROE-2700

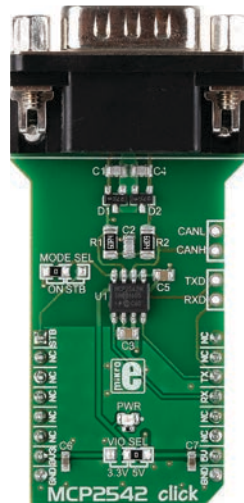

MCP2542 Click

5V | 3.3V | SPI | I2C
 UART | GPIO | PWM | AN

Microchip's CAN FD Transceiver with Wake-Up Pattern. Compliant with CAN 2.0 and CAN FD.

MSRP – \$20⁰⁰
 MIKROE-2299

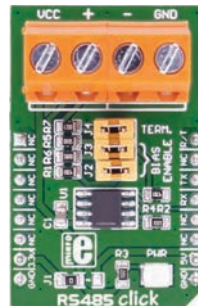

RS485 Click 3.3V

5V | 3.3V | SPI | I2C
 UART | GPIO | PWM | AN

Carries SN-65HVD12 half-duplex, RS-485 transceiver from Texas Instruments.

MSRP – \$18⁰⁰
 MIKROE-989

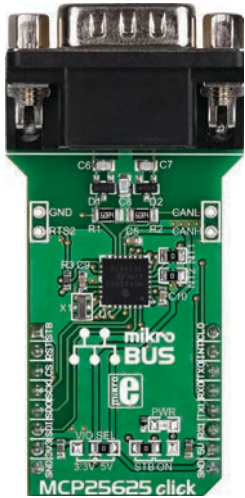

MCP25625 Click

5V 3.3V SPI I2C

UART GPIO PWM AN

With CAN controller with an integrated transceiver. High speed operation up to 1 Mb/s.

MSRP – \$24⁰⁰
MIKROE-2228

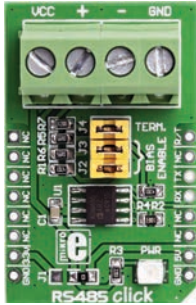

RS485 Click 5V

5V 3.3V SPI I2C

UART GPIO PWM AN

Carries the ADM485 differential line transceiver from Analog Devices.

MSRP – \$18⁰⁰
MIKROE-925

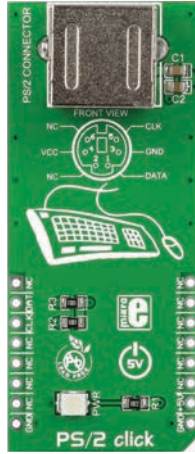

PS/2 Click

5V 3.3V SPI I2C

UART GPIO PWM AN

Adds keyboard and mouse connectivity. With a standard 6-pin Mini-DIN PS/2 connector.

MSRP – \$9⁰⁰
MIKROE-1576

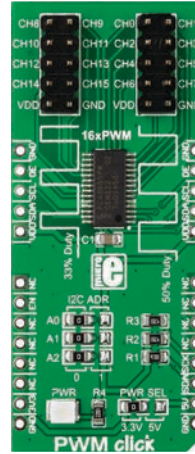

PWM Click

5V 3.3V SPI I2C

UART GPIO PWM AN

For controlling 16 PWM outputs through a single I2C interface. With PCA9685PW IC.

MSRP – \$14⁹⁰
MIKROE-1898

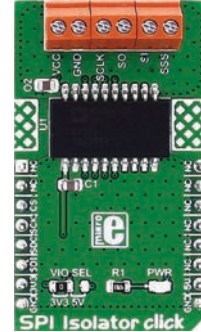

SPI Isolator Click

5V 3.3V SPI I2C

UART GPIO PWM AN

Carries ADuM4154 5kV digital isolator optimized for a serial peripheral interface [SPI].

MSRP – \$29⁰⁰
MIKROE-2583

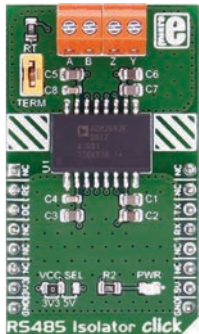

RS485 Isolator Click

5V | 3.3V | SPI | I2C
 UART | GPIO | PWM | AN

With ADM2682EBRIZ, a 5 kV RMS signal and power isolated RS-485 transceiver.

MSRP - \$49⁰⁰
 MIKROE-2673

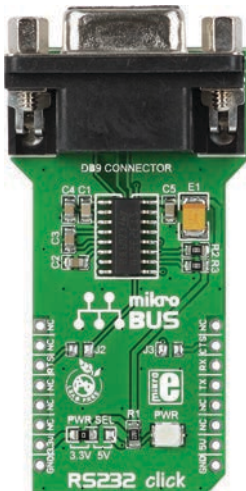

RS232 Click

5V | 3.3V | SPI | I2C
 UART | GPIO | PWM | AN

Adds RS232 connectivity with a standard RS232 DB9 port and a MAX3232 IC.

MSRP - \$15⁰⁰
 MIKROE-1582

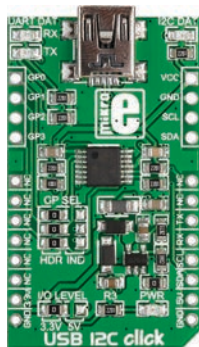

USB I2C Click

5V | 3.3V | SPI | I2C
 UART | GPIO | PWM | AN

With MCP2221 USB-to-UART/I2C converter. Full-speed USB [12 Mb/s], I2C up to 400 kHz clock rates.

MSRP - \$13⁹⁰
 MIKROE-1985

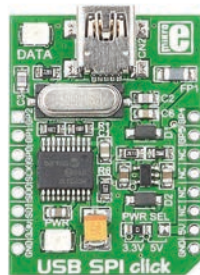

USB SPI Click

5V | 3.3V | SPI | I2C
 UART | GPIO | PWM | AN

Microchip's MCP2210 USB-to-SPI protocol converter with GPIO as well as USB MINI B connector.

MSRP - \$13⁹⁰
 MIKROE-1204



USB UART 2 Click

5V | 3.3V | SPI | I2C
 UART | GPIO | PWM | AN

Provides USB isolation and carries the AD-UM4160BRWZ USB port isolator.

MSRP - \$39⁰⁰
 MIKROE-2674

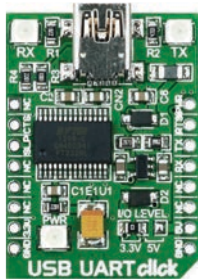

USB UART Click

5V | 3.3V | SPI | I2C
 UART | GPIO | PWM | AN

Adds serial UART communication via USB cable. With FT232RL USB-to-UART interface module.

MSRP – \$13⁹⁰
 MIKROE-1203

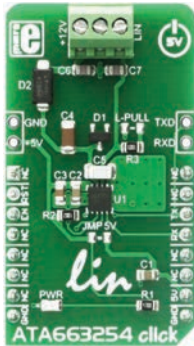

ATA663254 Click

5V | 3.3V | SPI | I2C
 UART | GPIO | PWM | AN

It is a fully integrated LIN transceiver device with an integrated 5V LDO voltage regulator.

MSRP – \$16⁹⁰
 MIKROE-2872



BroadR-Reach Click

5V | 3.3V | SPI | I2C
 UART | GPIO | PWM | AN

For realizing network in harsh environments that require reliable Ethernet-based open network.

MSRP – \$69⁹⁰
 MIKROE-2796

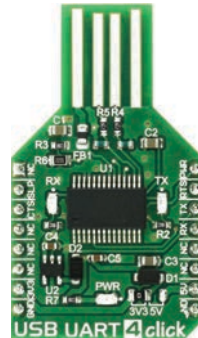

USB UART 4 Click

5V | 3.3V | SPI | I2C
 UART | GPIO | PWM | AN

USB to asynchronous serial data transfer interface. With FT232RL, USB-to-UART interface module.

MSRP – \$13⁹⁰
 MIKROE-2810

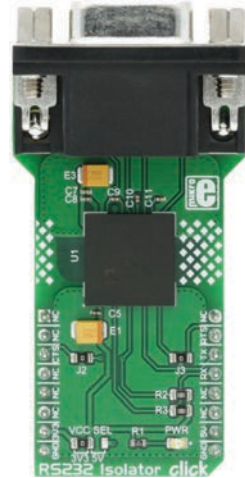

RS232 Isolator Click

5V | 3.3V | SPI | I2C
 UART | GPIO | PWM | AN

Isolated dual transceiver Click - secure and easy UART to RS232 conversion, with galvanic isolation.

MSRP – \$56⁹⁰
 MIKROE-2864

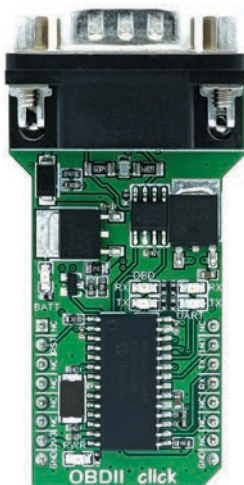

OBDII Click

5V | 3.3V | SPI | I2C
 UART | GPIO | PWM | AN

Tap inside the car diagnostic systems! Features the STN1110 Multiprotocol OBD to UART Interface.

MSRP – \$47⁹⁰
 MIKROE-2452

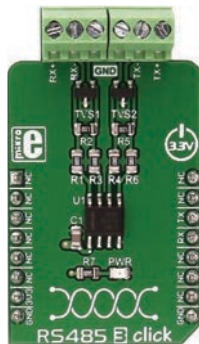

RS485 3 Click

5V | 3.3V | SPI | I2C
 UART | GPIO | PWM | AN

The Click is intended to be used as UART to RS422/RS485 communication interface.

MSRP – \$20⁰⁰
 MIKROE-2821



PWM 2 Click

5V | 3.3V | SPI | I2C
 UART | GPIO | PWM | AN

With the LT8500, a 48-Channel LED PWM generator with 12-Bit res. and 50MHz serial interface.

MSRP – \$19⁰⁰
 MIKROE-3148

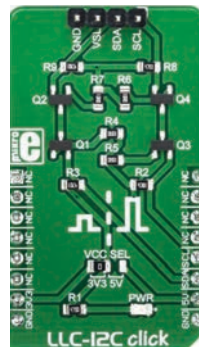

LLC-I2C Click

5V | 3.3V | SPI | I2C
 UART | GPIO | PWM | AN

Used as the level converter for logic signals. It is perfectly suited for the bi-directional I2C communication.

MSRP – \$9⁰⁰
 MIKROE-3276

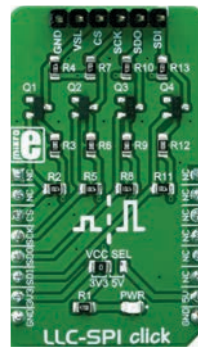

LLC-SPI Click

5V | 3.3V | SPI | I2C
 UART | GPIO | PWM | AN

Used as the level converter for logic signals. It is perfectly suited for SPI communication.

MSRP – \$9⁰⁰
 MIKROE-3298

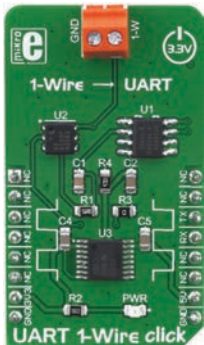

UART 1-Wire Click

5V | 3.3V | SPI | I2C

UART | GPIO | PWM | AN

Designed to convert standard UART or RS232 signals into 1-Wire® signals.

MSRP – \$22⁰⁰
MIKROE-3340



4D - display Click

5V | 3.3V | SPI | I2C

UART | GPIO | PWM | AN

Offers a mikroBUS™ interface for controlling 4D Systems gen4 Series intelligent Display Modules.

MSRP – \$9⁰⁰
MIKROE-3044



Skywire™ Click

5V | 3.3V | SPI | I2C

UART | GPIO | PWM | AN

Adapter Click, which hosts NimbeLink/Skywire™ cellular modems [using stacking headers].

MSRP – \$19⁰⁰
MIKROE-2405

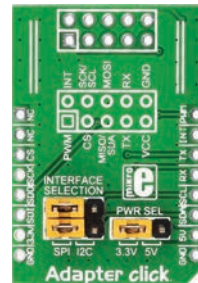

Adapter Click

5V | 3.3V | SPI | I2C

UART | GPIO | PWM | AN

Simplifies connection of the add-on boards with IDC10 headers to mikroBUS™ socket.

MSRP – \$6⁵⁰
MIKROE-1432



Riverdi Click

5V | 3.3V | SPI | I2C

UART | GPIO | PWM | AN

An adapter for connecting Riverdi TFT displays to a mikroBUS™ socket.

MSRP – \$9⁰⁰
MIKROE-2100

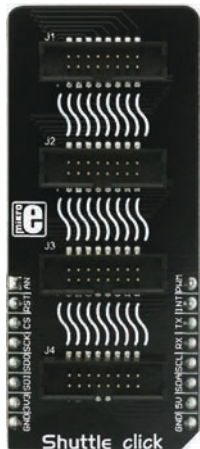

Shuttle Click

5V 3.3V SPI I2C
UART GPIO PWM AN

The mikroBUS™ socket expansion board, which allows stacking up to four Click boards™.

MSRP – \$8⁰⁰
MIKROE-2880

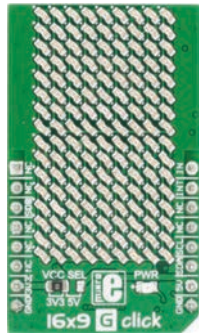

16x9 G Click

5V 3.3V SPI I2C
UART GPIO PWM AN

With a green 16x9 LED matrix and IS31FL3731 audio modulated matrix LED driver.

MSRP – \$34⁰⁰
MIKROE-2520

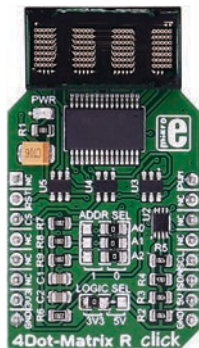

4Dot-Matrix R Click

5V 3.3V SPI I2C
UART GPIO PWM AN

Displays 4 char. of 5x7 dot size. With SLO2016 module and MCP23017 I2C port expander.

MSRP – \$59⁰⁰
MIKROE-2706

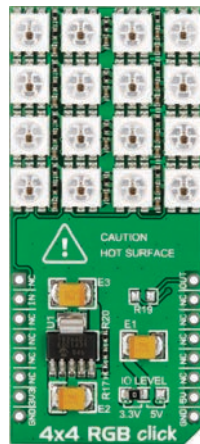

4x4 RGB Click

5V 3.3V SPI I2C
UART GPIO PWM AN

With a matrix of 16 WS2812 RGB LEDs a MCP1826 low dropout regulator.

MSRP – \$19⁰⁰
MIKROE-1881

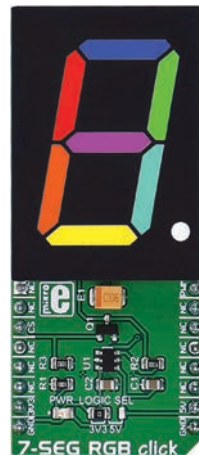

7-SEG RGB Click

5V 3.3V SPI I2C
UART GPIO PWM AN

Carries a full color single 7 segment digit display. 16,581,375 color combinations.

MSRP – \$29⁰⁰
MIKROE-2734

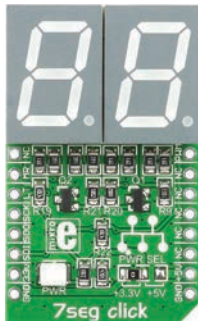

7seg Click

5V | 3.3V | SPI | I2C

UART | GPIO | PWM | AN

2-digit seven-seg display.
With two 74HC595 8-bit serial-in, parallel-out shift registers.

MSRP – \$10⁰⁰
MIKROE-1201

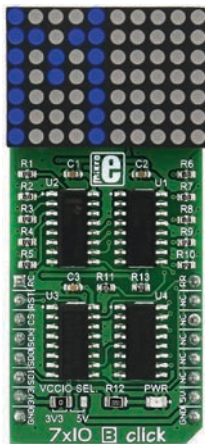

7x10 B Click

5V | 3.3V | SPI | I2C

UART | GPIO | PWM | AN

With a matrix of 70 blue LEDs driven by a pair of 8-bit serial-in, parallel-out shift registers.

MSRP – \$15⁰⁰
MIKROE-2789

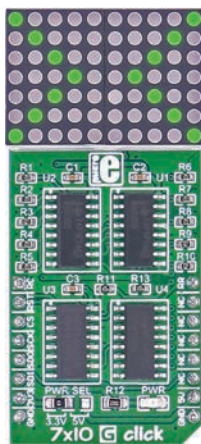

7x10 G Click

5V | 3.3V | SPI | I2C

UART | GPIO | PWM | AN

With a matrix of 70 green LEDs driven by a pair of 8-bit serial-in, parallel-out shift registers.

MSRP – \$15⁰⁰
MIKROE-2705

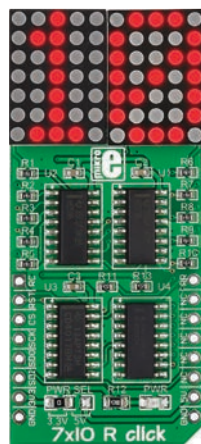

7x10 R Click

5V | 3.3V | SPI | I2C

UART | GPIO | PWM | AN

With a matrix of 70 red LEDs driven by a pair of 8-bit serial-in, parallel-out shift registers.

MSRP – \$15⁰⁰
MIKROE-1993

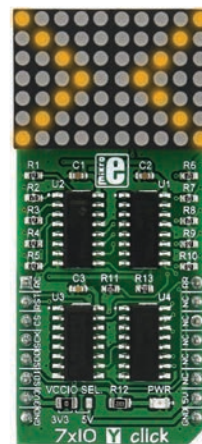

7x10 Y Click

5V | 3.3V | SPI | I2C

UART | GPIO | PWM | AN

With a matrix of 70 yellow LEDs driven by a pair of 8-bit serial-in, parallel-out shift registers.

MSRP – \$15⁰⁰
MIKROE-2790

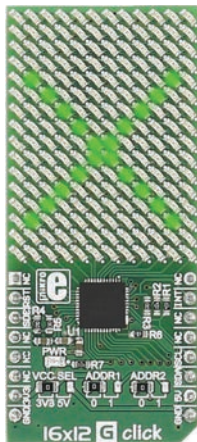

16x12 G Click

5V | 3.3V | SPI | I2C
 UART | GPIO | PWM | AN

Carries a 16x12 LED display and the IS-31FL3733 matrix driver with 1/12 cycle rate.

MSRP – \$30⁰⁰
 MIKROE-2758

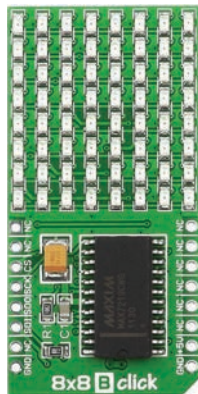

8x8 B Click

5V | 3.3V | SPI | I2C
 UART | GPIO | PWM | AN

It features MAX7219 8-digit LED display driver module as well as 64 BLUE LEDs.

MSRP – \$18⁰⁰
 MIKROE-1307

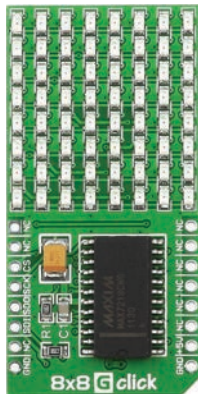

8x8 G Click

5V | 3.3V | SPI | I2C
 UART | GPIO | PWM | AN

It features MAX7219 8-digit LED display driver module as well as 64 GREEN LEDs.

MSRP – \$15⁰⁰
 MIKROE-1306

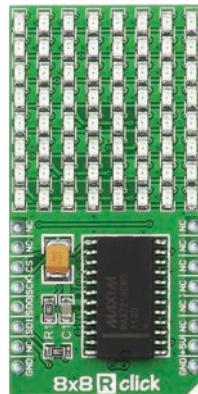

8x8 R Click

5V | 3.3V | SPI | I2C
 UART | GPIO | PWM | AN

It features MAX7219 8-digit LED display driver module as well as 64 RED LEDs.

MSRP – \$15⁰⁰
 MIKROE-1285

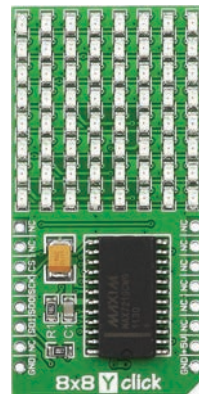

8x8 Y Click

5V | 3.3V | SPI | I2C
 UART | GPIO | PWM | AN

It features MAX7219 8-digit LED display driver module as well as 64 YELLOW LEDs.

MSRP – \$15⁰⁰
 MIKROE-1294

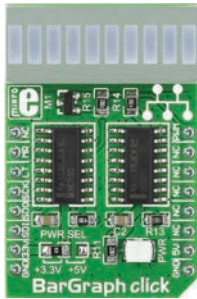

BarGraph Click

5V 3.3V SPI I2C

UART GPIO PWM AN

With 10-segment JSB-R102510Z light bar display and two 74HC595 8-bit shift registers.

MSRP – \$12⁰⁰
MIKROE-1423



BIG 7-SEG R Click

5V 3.3V SPI I2C

UART GPIO PWM AN

With SC10-21SR-WA seven-segment display and parallel-OUT shift register 74HC595.

MSRP – \$19⁰⁰
MIKROE-2269

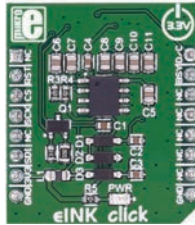

eINK Click

5V 3.3V SPI I2C

UART GPIO PWM AN

With an adapter for connecting eINK displays, with a 24pin ribbon cable.

MSRP – \$59⁰⁰
MIKROE-2659



EVE Click

5V 3.3V SPI I2C

UART GPIO PWM AN

Brings visually stunning graphics even to 8-bit MCUs, with FT800Q graphics controller.

MSRP – \$39⁰⁰
MIKROE-1430

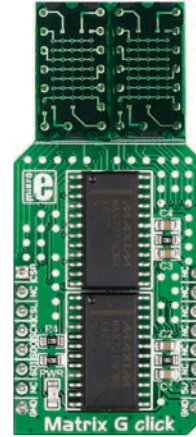

Matrix G Click

5V 3.3V SPI I2C

UART GPIO PWM AN

Matrix text display with two green 5x7 matrices and two MAX7219 8-bit LED display drivers.

MSRP – \$29⁰⁰
MIKROE-2246

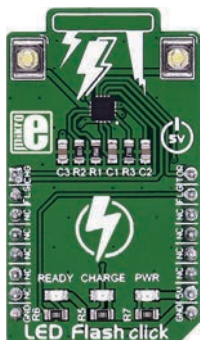

LED Flash Click

5V | 3.3V | SPI | I2C
 UART | GPIO | PWM | AN

Functions as a high power LED flash, and carries the CAT3224 flash LED driver.

MSRP – \$34⁰⁰
 MIKROE-2479

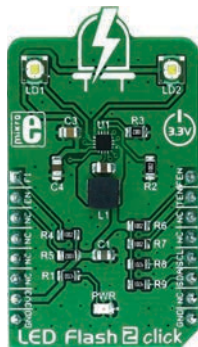

LED Flash 2 Click

5V | 3.3V | SPI | I2C
 UART | GPIO | PWM | AN

It is a powerful flash/torch Click, featuring the MIC2870 from Microchip.

MSRP – \$19⁰⁰
 MIKROE-2830

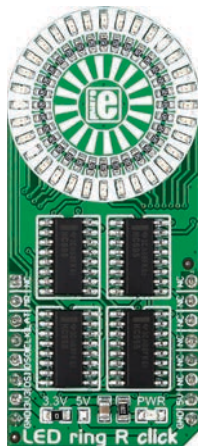

LED ring R Click

5V | 3.3V | SPI | I2C
 UART | GPIO | PWM | AN

With a ring of 32 red LEDs driven by four 74HC595 serial-in, parallel-out shift registers.

MSRP – \$16⁰⁰
 MIKROE-2155

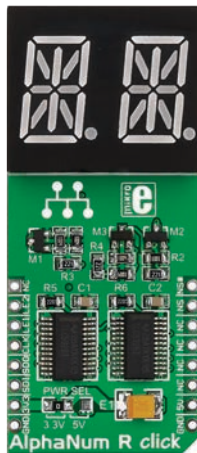

AlphaNum R Click

5V | 3.3V | SPI | I2C
 UART | GPIO | PWM | AN

With a dual character red LED 14-segment display and two TLC5926 16-bit shift registers.

MSRP – \$15⁰⁰
 MIKROE-1864

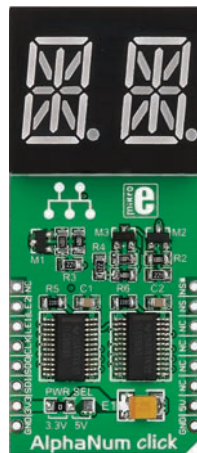

AlphaNum G Click

5V | 3.3V | SPI | I2C
 UART | GPIO | PWM | AN

With a dual character green LED 14-segment display and two TLC5926 16-bit shift registers.

MSRP – \$15⁰⁰
 MIKROE-1851



Matrix R Click

5V | 3.3V | SPI | I2C

UART | GPIO | PWM | AN

Matrix text display with two red 5x7 matrices and two MAX7219 8-bit LED display drivers.

MSRP – \$29⁰⁰
MIKROE-2245

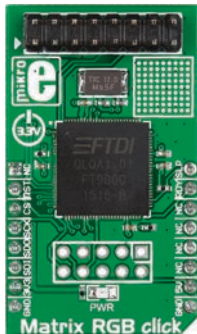

Matrix RGB Click

5V | 3.3V | SPI | I2C

UART | GPIO | PWM | AN

Powered by a 32-bit FT900 MCU designed specifically for powering 16x32 RGB LED matrices.

MSRP – \$24⁰⁰
MIKROE-2239

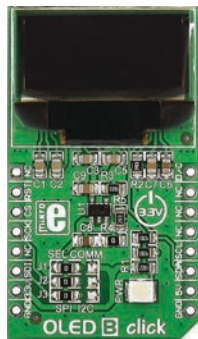

OLED B Click

5V | 3.3V | SPI | I2C

UART | GPIO | PWM | AN

With a 96 x 39px blue monochrome passive matrix OLED display and SSD1306 controller.

MSRP – \$24⁰⁰
MIKROE-1650

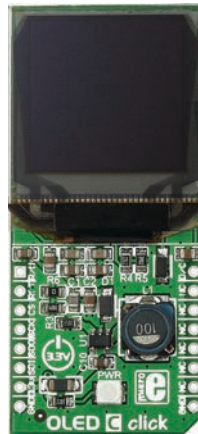

OLED C Click

5V | 3.3V | SPI | I2C

UART | GPIO | PWM | AN

With PSP27801 OLED display and SSD1351 OLED driver with controller. Various color support.

MSRP – \$29⁰⁰
MIKROE-1585



LCD mini Click

5V | 3.3V | SPI | I2C

UART | GPIO | PWM | AN

Displays 2x16 monochrome characters on an LMB162XFW LCD display.

MSRP – \$19⁰⁰
MIKROE-2453

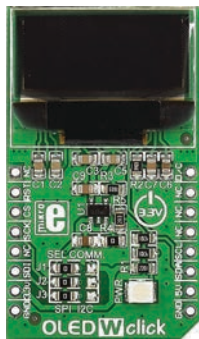

OLED W Click

5V 3.3V SPI I2C

UART GPIO PWM AN

Carries a 96x39px white monochrome passive matrix OLED display.

MSRP - \$24⁰⁰
MIKROE-1649

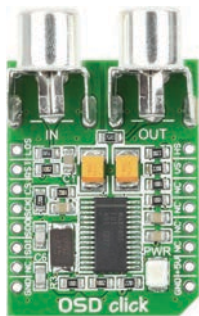

OSD Click

5V 3.3V SPI I2C

UART GPIO PWM AN

With MAX7456 single-channel monochrome OSD module with integrated EEPROM memory.

MSRP - \$35⁰⁰
MIKROE-1366

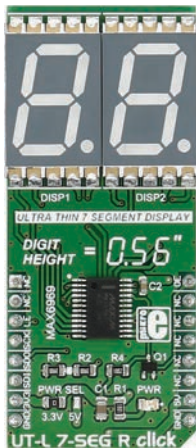

UT-L 7-SEG R Click

5V 3.3V SPI I2C

UART GPIO PWM AN

With two SMD ultra-thin LED 7-SEG displays and MAX6969 constant-current LED driver.

MSRP - \$44⁰⁰
MIKROE-2034

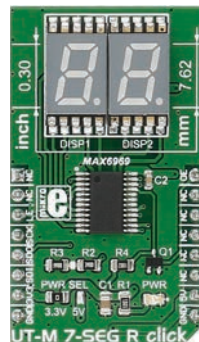

UT-M 7-SEG R Click

5V 3.3V SPI I2C

UART GPIO PWM AN

Add a double 7 segment display to your next project. RED emitting color.

MSRP - \$20⁰⁰
MIKROE-2746

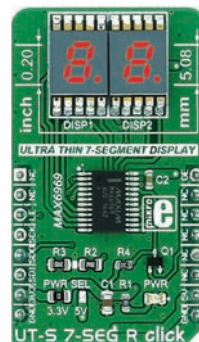

UT-S 7-SEG R Click

5V 3.3V SPI I2C

UART GPIO PWM AN

For displaying characters on two 7 segment displays. RED emitting color.

MSRP - \$20⁰⁰
MIKROE-2840



OLED Switch Click

5V | 3.3V | SPI | I2C
 UART | GPIO | PWM | AN

With NKK Switch IS-C15ANP4 that combines a switch and a full color organic LED display.

MSRP – \$99⁰⁰
 MIKROE-2449

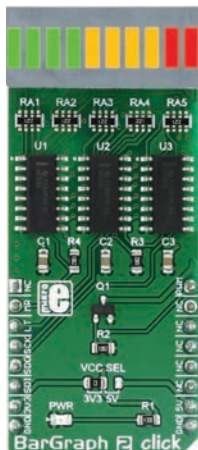

BarGraph 2 Click

5V | 3.3V | SPI | I2C
 UART | GPIO | PWM | AN

The 74HC595, 8-bit serial-in, parallel-out shift registers with output latches.

MSRP – \$19⁰⁰
 MIKROE-3021

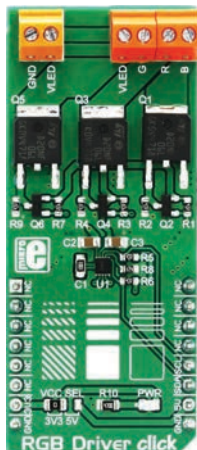

RGB Driver Click

5V | 3.3V | SPI | I2C
 UART | GPIO | PWM | AN

The NCP5623B, a triple output RGB LED driver, controlled via the I2C interface, from ON Semiconductors.

MSRP – \$15⁰⁰
 MIKROE-3078

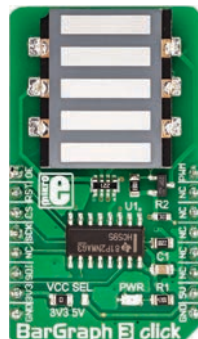

BarGraph 3 Click

5V | 3.3V | SPI | I2C
 UART | GPIO | PWM | AN

Uses a single 74HC595 IC, a tri-state, serial-in, parallel-out, 8-bit shift-register with output latch.

MSRP – \$15⁰⁰
 MIKROE-3264

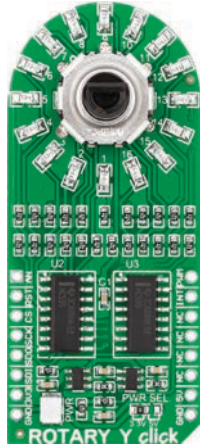

ROTARY Y Click

5V 3.3V SPI I2C
UART GPIO PWM AN

With a 15-pulse incremental rotary encoder with detents, surrounded by a ring of 16 yellow LEDs.

MSRP – \$12⁰⁰
MIKROE-1825

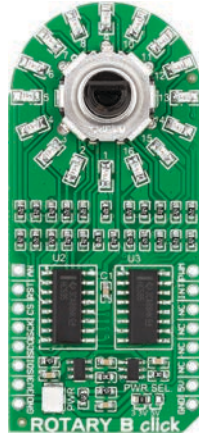

ROTARY B Click

5V 3.3V SPI I2C
UART GPIO PWM AN

With a 15-pulse incremental rotary encoder with detents, surrounded by a ring of 16 blue LEDs.

MSRP – \$12⁰⁰
MIKROE-1824

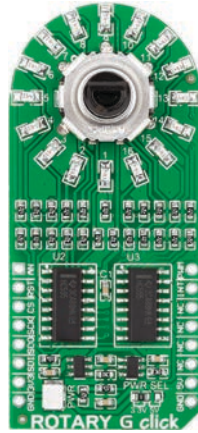

ROTARY G Click

5V 3.3V SPI I2C
UART GPIO PWM AN

With a 15-pulse incremental rotary encoder with detents, surrounded by a ring of 16 green LEDs.

MSRP – \$12⁰⁰
MIKROE-1822

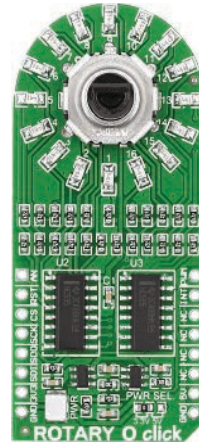

ROTARY O Click

5V 3.3V SPI I2C
UART GPIO PWM AN

With a 15-pulse incremental rotary encoder with detents, surrounded by a ring of 16 orange LEDs.

MSRP – \$12⁰⁰
MIKROE-2380

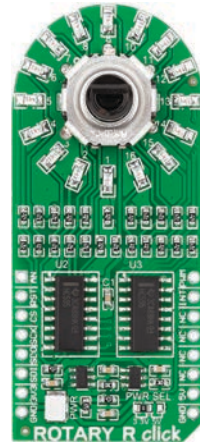

ROTARY R Click

5V 3.3V SPI I2C
UART GPIO PWM AN

With a 15-pulse incremental rotary encoder with detents, surrounded by a ring of 16 red LEDs.

MSRP – \$12⁰⁰
MIKROE-1823



CapSense Click

5V 3.3V SPI I2C

UART GPIO PWM AN

Capacitive sensing module. Input- human body capacitance, output - the real time sensor information.

MSRP - \$16⁰⁰
MIKROE-1446

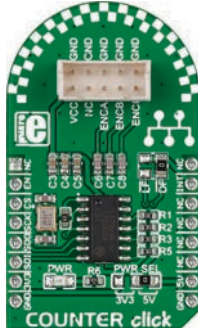

COUNTER Click

5V 3.3V SPI I2C

UART GPIO PWM AN

Counter Click carries an LS7366R 32-bit quadrature counter.

MSRP - \$25⁰⁰
MIKROE-1917



Fingerprint Click

5V 3.3V SPI I2C

UART GPIO PWM AN

Solution for adding biometric security to your design.

MSRP - \$55⁰⁰
MIKROE-1722

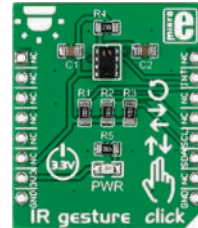

IR gesture Click

5V 3.3V SPI I2C

UART GPIO PWM AN

Enables contactless gesture recognition. With ambient light and proximity sensing capabilities.

MSRP - \$16⁰⁰
MIKROE-2086

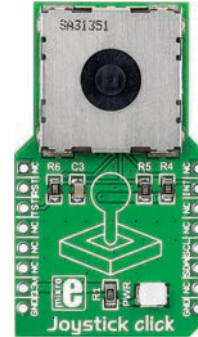

Joystick Click

5V 3.3V SPI I2C

UART GPIO PWM AN

A smart navigation key concept based on contactless, magnetic movement detection.

MSRP - \$22⁰⁰
MIKROE-1506

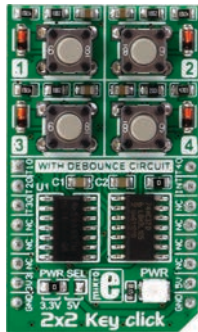

2x2 Key Click

5V | 3.3V | SPI | I2C
UART | GPIO | PWM | AN

The Click has a 4 button keypad. It allows multiple key presses and has a debounce circuit.

MSRP – \$9⁰⁰
MIKROE-2152

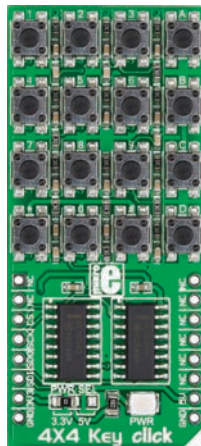

4x4 Key Click

5V | 3.3V | SPI | I2C
UART | GPIO | PWM | AN

Carries a 16 button keypad. Allows for multiple key presses at the same time.

MSRP – \$11⁰⁰
MIKROE-1889



Button G Click

5V | 3.3V | SPI | I2C
UART | GPIO | PWM | AN

A single pushbutton - transparent, 6.8mm in diameter, with a green LED backlight.

MSRP – \$9⁰⁰
MIKROE-2040



Button R Click

5V | 3.3V | SPI | I2C
UART | GPIO | PWM | AN

A single pushbutton - transparent, 6.8mm in diameter, with a red LED backlight.

MSRP – \$9⁰⁰
MIKROE-1901



Cap Extend Click

5V | 3.3V | SPI | I2C
UART | GPIO | PWM | AN

With SX8633, capacitive button touch controller. 12 pins for connecting capacitive inputs.

MSRP – \$18⁰⁰
MIKROE-2238

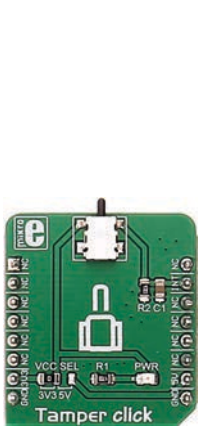

Tammer Click

5V | 3.3V | SPI | I2C
 UART | GPIO | PWM | AN

Equipped with SDS001, a low profile side-actuated detect switch.

MSRP – \$9⁰⁰
 MIKROE-2551

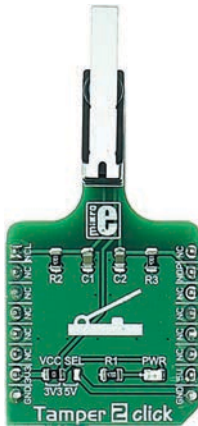

Tammer 2 Click

5V | 3.3V | SPI | I2C
 UART | GPIO | PWM | AN

Levered D2HW-A221D switch. Outputs signal in both positions - pressed and released.

MSRP – \$15⁰⁰
 MIKROE-2552



Thumb wheel Click

5V | 3.3V | SPI | I2C
 UART | GPIO | PWM | AN

With a 10-position rotary sprocket connected to a 1-Wire 8-Channel Addressable Switch.

MSRP – \$29⁰⁰
 MIKROE-2366



TouchClamp Click

5V | 3.3V | SPI | I2C
 UART | GPIO | PWM | AN

With NXP's MPR121 proximity capacitive touch sensor controller. 7 plated holes for clamps.

MSRP – \$9⁰⁰
 MIKROE-2294



Keylock Click

5V | 3.3V | SPI | I2C
 UART | GPIO | PWM | AN

Carries a processed sealed key lock mechanism that can be set in 3 different positions.

MSRP – \$25⁰⁰
 MIKROE-2564

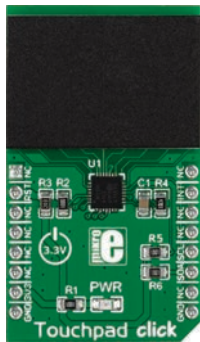

Touchpad Click

5V | 3.3V | SPI | I2C
UART | GPIO | PWM | AN

Capacitive touch input device driven by Microchip's MTCH6102 controller.

MSRP – \$15⁰⁰
MIKROE-1995



Thumbstick Click

5V | 3.3V | SPI | I2C
UART | GPIO | PWM | AN

A high precision input device with a dual axis, spring return and push-button enabled joystick.

MSRP – \$20⁰⁰
MIKROE-1627



Cap Extend 3 Click

5V | 3.3V | SPI | I2C
UART | GPIO | PWM | AN

With four capacitive sensor pads that can sense touch through a variety of different materials.

MSRP – \$16⁰⁰
MIKROE-2474



Cap Touch Click

5V | 3.3V | SPI | I2C
UART | GPIO | PWM | AN

A capacitive touch sensing button, integrated on a Click board™.

MSRP – \$16⁰⁰
MIKROE-2888

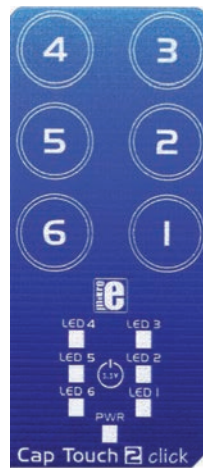

Cap Touch 2 Click

5V | 3.3V | SPI | I2C
UART | GPIO | PWM | AN

a capacitive touch sensing button, which features the CAP1166.

MSRP – \$15⁰⁰
MIKROE-2964

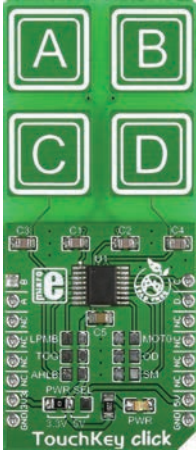

TouchKey Click

5V | 3.3V | SPI | I2C

UART | GPIO | PWM | AN

It has four capacitive pads powered by TTP224, a touch-pad detector IC.

MSRP – \$12⁰⁰
MIKROE-1906



TouchKey 2 Click

5V | 3.3V | SPI | I2C

UART | GPIO | PWM | AN

With 4 capacitive pads powered by Microchip's ATtiny817. Integrated touch QTouch® controller.

MSRP – \$16⁰⁰
MIKROE-2474



TouchKey 3 Click

5V | 3.3V | SPI | I2C

UART | GPIO | PWM | AN

Equipped with advanced capacitive sensors, based on the proprietary QTouch® technology.

MSRP – \$19⁰⁰
MIKROE-2405



TouchKey 4 Click

5V | 3.3V | SPI | I2C

UART | GPIO | PWM | AN

A capacitive touch sensing button, with the advanced touch/proximity sensor IC.

MSRP – \$15⁰⁰
MIKROE-2965



Button Y Click

5V | 3.3V | SPI | I2C
UART | GPIO | PWM | AN

Designed with the high-quality, single-pole, single-throw (SPST) tactile switch labeled as 3006.2111.

MSRP - \$9⁰⁰
MIKROE-3262



Button PLAY Click

5V | 3.3V | SPI | I2C
UART | GPIO | PWM | AN

It is equipped with the CTHS15CIC05ARROW, a capacitive touch sensor display.

MSRP - \$21⁰⁰
MIKROE-3327



Knob G Click

5V | 3.3V | SPI | I2C
UART | GPIO | PWM | AN

Combination of high-quality quadrature rotary encoder, and a LED ring of 24 individual green LEDs.

MSRP - \$17⁰⁰
MIKROE-3299

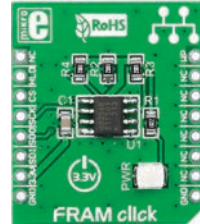

FRAM Click

5V | 3.3V | SPI | I2C
UART | GPIO | PWM | AN

256K [32,768 words x 8 bits] of Ferroelectric Random Access Memory with MB85RS256A module.

MSRP - \$15⁰⁰
MIKROE-1486



FRAM 2 Click

5V | 3.3V | SPI | I2C
UART | GPIO | PWM | AN

With CY15B104Q 4-Mbit [512K x 8] serial F-RAM from Cypress. 100 trillion [10¹⁴] read/writes.

MSRP - \$19⁰⁰
MIKROE-2768

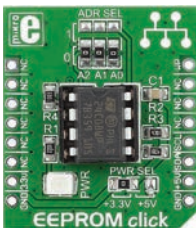

EEPROM Click

5V | 3.3V | SPI | I2C

UART | GPIO | PWM | AN

With 24C08WP - a highly reliable, high performance CMOS technology serial 8K EEPROM.

MSRP - \$8⁰⁰
MIKROE-1200



EEPROM 2 Click

5V | 3.3V | SPI | I2C

UART | GPIO | PWM | AN

With M95M02-DR DIP-8 socket EEPROM chip with 256 KB of memory from STMicroelectronics.

MSRP - \$18⁰⁰
MIKROE-1909



EEPROM 3 Click

5V | 3.3V | SPI | I2C

UART | GPIO | PWM | AN

With AT24CM02 DIP-8 socket EEPROM chip with 256 KB of memory from Microchip.

MSRP - \$14⁰⁰
MIKROE-1989

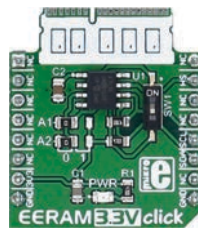

EERAM 3.3V Click

5V | 3.3V | SPI | I2C

UART | GPIO | PWM | AN

With 47L16 EERAM, a 16Kbit SRAM with EEPROM Backup from Microchip.

MSRP - \$14⁰⁰
MIKROE-2728

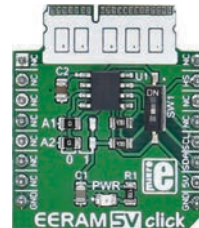

EERAM 5V Click

5V | 3.3V | SPI | I2C

UART | GPIO | PWM | AN

With 47C16 EERAM, a 16Kbit SRAM with EEPROM Backup from Microchip.

MSRP - \$14⁰⁰
MIKROE-2729

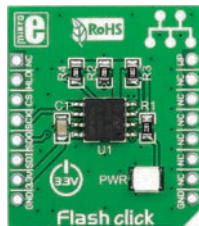

Flash Click

5V | 3.3V | SPI | I2C
 UART | GPIO | PWM | AN

With EN25Q80B - 8Mb serial Flash memory module. Clock frequency up to 75MHz.

MSRP - \$10⁰⁰
 MIKROE-1199

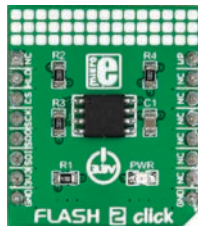

Flash 2 Click

5V | 3.3V | SPI | I2C
 UART | GPIO | PWM | AN

It carries Microchip's SST26VF064B flash-memory module with 64 Mbits capacity.

MSRP - \$12⁰⁰
 MIKROE-2267

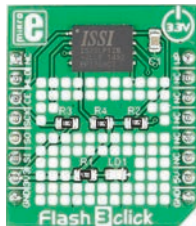

Flash 3 Click

5V | 3.3V | SPI | I2C
 UART | GPIO | PWM | AN

With ISSI's IS25LP128 IC with 128 Mbit capacity. 50MHz at Normal, 133MHz at Fast Read speeds.

MSRP - \$12⁰⁰
 MIKROE-2374



Flash 4 Click

5V | 3.3V | SPI | I2C
 UART | GPIO | PWM | AN

Carries the S25FL512S, a 512 Mbit SPI Flash memory module.

MSRP - \$25⁰⁰
 MIKROE-3191

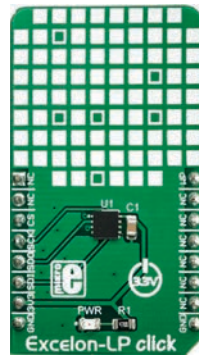

Excelon-LP Click

5V | 3.3V | SPI | I2C
 UART | GPIO | PWM | AN

Equipped with the CY15B108Q, a serial ferroelectric (FRAM) module with 8 Mbit density.

MSRP - \$25⁰⁰
 MIKROE-3104



MAC Address Click

5V | 3.3V | SPI | I2C

UART | GPIO | PWM | AN

A unique node address. Carries 24AA025E64 2Kb Serial EEPROM with EUI-64™ node identity.

MSRP – \$9⁰⁰
MIKROE-2733



microSD Click

5V | 3.3V | SPI | I2C

UART | GPIO | PWM | AN

With a microSD card slot for microSD cards used as a mass storage media for portable devices.

MSRP – \$16⁰⁰
MIKROE-924



Secure Click

5V | 3.3V | SPI | I2C

UART | GPIO | PWM | AN

With ATECC508A cryptographic coprocessor with secure hardware-based key storage.

MSRP – \$9⁰⁰
MIKROE-252

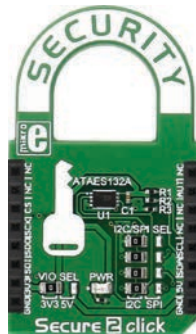

Secure 2 Click

5V | 3.3V | SPI | I2C

UART | GPIO | PWM | AN

Microchip's ATAES132A, a cryptographic coprocessor with secure hardware-based key storage.

MSRP – \$9⁰⁰
MIKROE-2760



Secure 3 Click

5V | 3.3V | SPI | I2C

UART | GPIO | PWM | AN

Microchip's ATSHA204A, a cryptographic coprocessor with secure hardware-based key storage.

MSRP – \$9⁰⁰
MIKROE-2761



Secure 4 Click

5V 3.3V SPI I2C

UART GPIO PWM AN

Includes the ATECC608A, a secure CryptoAuthentication™ device from Microchip.

MSRP – \$9⁰⁰
MIKROE-2829

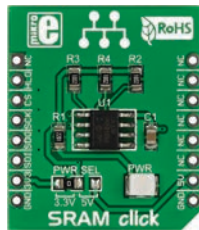

SRAM Click

5V 3.3V SPI I2C

UART GPIO PWM AN

Provides 1 Mbit of additional SRAM memory, via Microchip's 23LC1024.

MSRP – \$15⁰⁰
MIKROE-1902

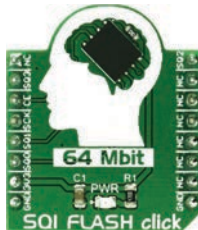

SQI FLASH Click

5V 3.3V SPI I2C

UART GPIO PWM AN

Based on the SST-26VF064B, a 64 Mbit Serial Quad I/O flash device from Microchip.

MSRP – \$13⁹⁰
MIKROE-2828

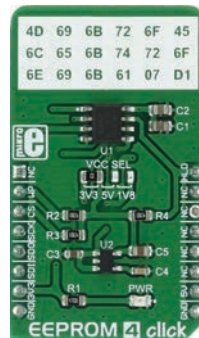

EEPROM 4 Click

5V 3.3V SPI I2C

UART GPIO PWM AN

An EEPROM memory medium with the capacity of 256KB.

MSRP – \$15⁰⁰
MIKROE-2536

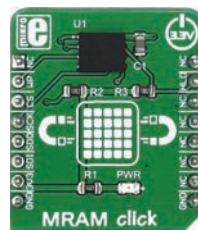

MRAM Click

5V 3.3V SPI I2C

UART GPIO PWM AN

Uses the MR25H256, a 256 kilobits serial SPI MRAM memory module from Everspin company.

MSRP – \$18⁰⁰
MIKROE-2914

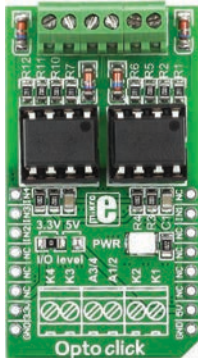

Opto Click

5V 3.3V SPI I2C
UART GPIO PWM AN

It features two V02630 dual channel, high speed optocoupler modules.

MSRP – \$21⁰⁰
MIKROE-1196



RELAY Click

5V 3.3V SPI I2C
UART GPIO PWM AN

With two G6D1AA-SI-5DC power PCB relay modules. Controls up to 5A, 250V AC/30V DC loads.

MSRP – \$18⁰⁰
MIKROE-1370

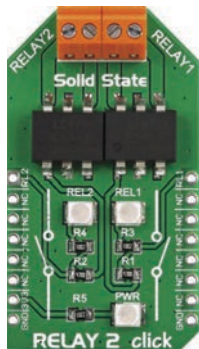

Relay 2 Click

5V 3.3V SPI I2C
UART GPIO PWM AN

Carries two LCA717 single-pole, OptoMOS® solid state relays.

MSRP – \$26⁰⁰
MIKROE-1899

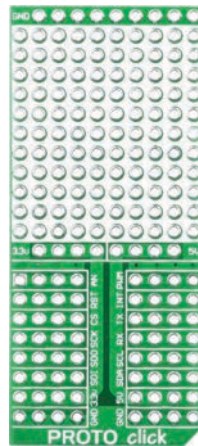

PROTO Click

5V 3.3V SPI I2C
UART GPIO PWM AN

10x11 prototyping area and additional power pads for creating custom electronics or Click boards™.

MSRP – \$4⁵⁰
MIKROE-1507

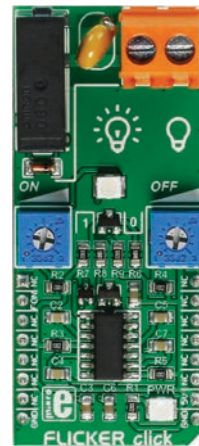

FLICKER Click

5V 3.3V SPI I2C
UART GPIO PWM AN

TI's NA556 dual precision timer and Omron's G6D-ASI power PCB relay. ON/OFF 0.1-6 sec.

MSRP – \$19⁰⁰
MIKROE-2481

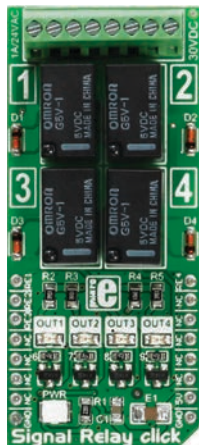

Signal Relay Click

5V 3.3V SPI I2C
UART GPIO PWM AN

It carries four ultra-small GV5-1 PCB relays from Omron. For ON/OFF control.

MSRP – \$29⁰⁰
MIKROE-2154

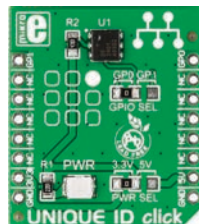

UNIQUE ID Click

5V 3.3V SPI I2C
UART GPIO PWM AN

With DS2401 enhanced silicon serial number IC. Provides a unique registration number.

MSRP – \$9⁰⁰
MIKROE-1819

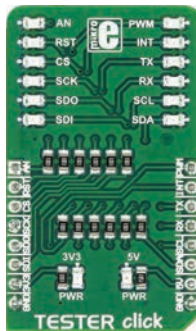

TESTER Click

5V 3.3V SPI I2C
UART GPIO PWM AN

An ideal solution for testing and diagnostics of the mikroBUS™ socket pin states.

MSRP – \$6⁰⁰
MIKROE-3083

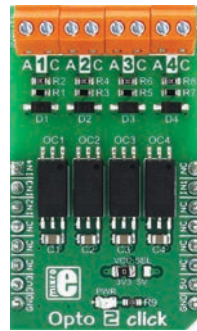

Opto 2 Click

5V 3.3V SPI I2C
UART GPIO PWM AN

Uses four TLP2770, 20-Mbps low-power optocouplers, from Toshiba.

MSRP – \$25⁰⁰
MIKROE-3015

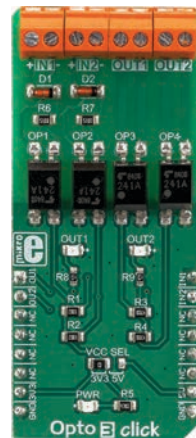

Opto 3 Click

5V 3.3V SPI I2C
UART GPIO PWM AN

Two pairs of normally opened, high-quality solid-state relays labeled as TLP241A.

MSRP – \$21⁰⁰
MIKROE-3319

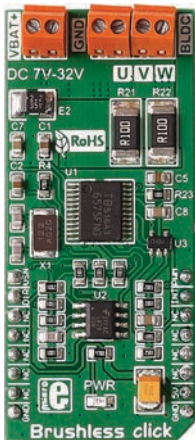

Brushless Click

5V | 3.3V | SPI | I2C

UART | GPIO | PWM | AN

Toshiba's TB6757F-NG IC for driving 3-phase full-wave Brushless DC motors.

MSRP - \$39⁰⁰
MIKROE-2441

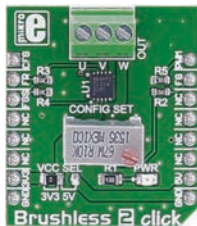

Brushless 2 Click

5V | 3.3V | SPI | I2C

UART | GPIO | PWM | AN

It carries TI's DRV10964 BLDC motor controller with an integrated output stage.

MSRP - \$26⁰⁰
MIKROE-2754



Brushless 3 Click

5V | 3.3V | SPI | I2C

UART | GPIO | PWM | AN

With TI's DRV10983 three-phase sensorless motor driver with integrated power MOSFETs.

MSRP - \$19⁰⁰
MIKROE-2766

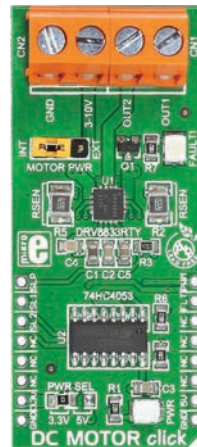

DC MOTOR Click

5V | 3.3V | SPI | I2C

UART | GPIO | PWM | AN

With TI's DRV8833RT-1YH-Bridge motor driver and TI's 74HC4053 multiplexer.

MSRP - \$18⁰⁰
MIKROE-1526



DC MOTOR 2 Click

5V | 3.3V | SPI | I2C

UART | GPIO | PWM | AN

With Toshiba's TB6593F-NG driver IC for direct current motors. Motors' supply voltage 2.5V-13V.

MSRP - \$17⁰⁰
MIKROE-2699



DC MOTOR 3 Click

5V 3.3V SPI I2C
UART GPIO PWM AN

With Toshiba's TB-6549FG full-bridge driver for direct current motors. Up to 3.5A with 30V.

MSRP – \$19⁰⁰
MIKROE-2047

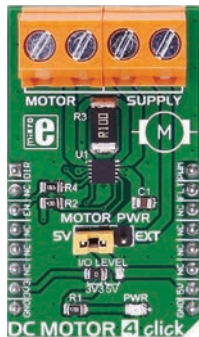

DC MOTOR 4 Click

5V 3.3V SPI I2C
UART GPIO PWM AN

With MAX14870 motor driver from Maxim Integrated. Motors' voltage supply 4.5V-36V.

MSRP – \$15⁰⁰
MIKROE-2221

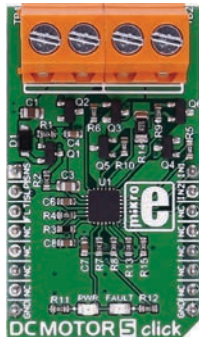

DC MOTOR 5 Click

5V 3.3V SPI I2C
UART GPIO PWM AN

With TI's DRV8701 brushed DC motor full-bridge gate driver. Operating voltage supply 5.9V-45V.

MSRP – \$17⁰⁰
MIKROE-2699

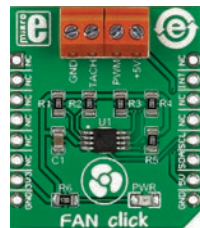

Fan Click

5V 3.3V SPI I2C
UART GPIO PWM AN

With EMC2301 controller for powering and regulating the operation of 5V four-wire fans.

MSRP – \$9⁰⁰
MIKROE-2004



Fan 2 Click

5V 3.3V SPI I2C
UART GPIO PWM AN

With MAX31760 precision fan-speed controller. Can control two fans at the same time.

MSRP – \$15⁰⁰
MIKROE-2708

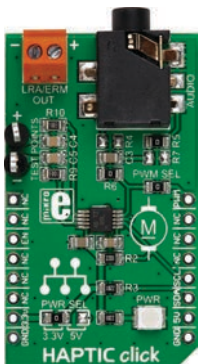

HAPTIC Click

5V | 3.3V | SPI | I2C

UART | GPIO | PWM | AN

With DRV2605 Haptic Driver for ERM and LRA vibration motors. Over 100 haptic effects library.

MSRP – \$23⁰⁰
MIKROE-2025



PWM driver Click

5V | 3.3V | SPI | I2C

UART | GPIO | PWM | AN

Silicon Labs' Si8711CC one-channel isolator for controlling DC motors with loads up to 10A.

MSRP – \$14⁰⁰
MIKROE-2272

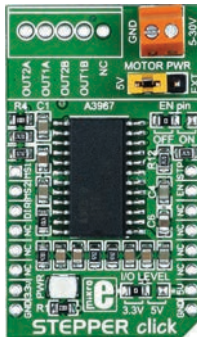

STEPPER Click

5V | 3.3V | SPI | I2C

UART | GPIO | PWM | AN

With A3967SLBT microstepping motor driver with a built-in translator. Max. output drive 30V, ±500 mA.

MSRP – \$18⁰⁰
MIKROE-1528

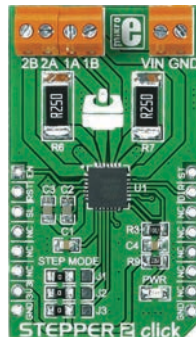

STEPPER 2 Click

5V | 3.3V | SPI | I2C

UART | GPIO | PWM | AN

With A4988 microstepping motor driver. Required external power supply minimum 7V.

MSRP – \$19⁰⁰
MIKROE-1926

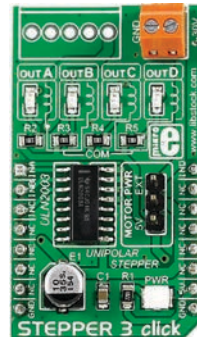

STEPPER 3 Click

5V | 3.3V | SPI | I2C

UART | GPIO | PWM | AN

With TI's ULN2003 High-Current Darlington transistor array. For precise motor control.

MSRP – \$19⁰⁰
MIKROE-2035

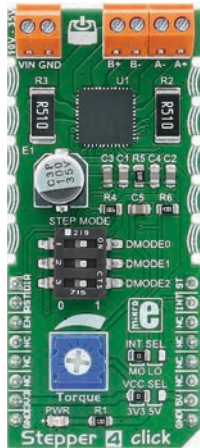

STEPPER 4 Click

5V | 3.3V | SPI | I2C

UART | GPIO | PWM | AN

With TB67S269FTG two-phase bipolar stepping motor driver from Toshiba.

MSRP – \$19⁰⁰
MIKROE-2748

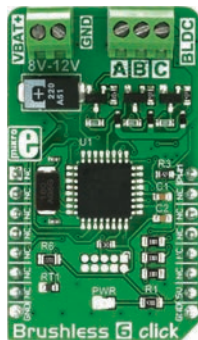

Brushless 6 Click

5V | 3.3V | SPI | I2C

UART | GPIO | PWM | AN

Designed to drive a three-phase sensorless, brushless motor. With ATmega8A from Microchip.

MSRP – \$27⁰⁰
MIKROE-2847

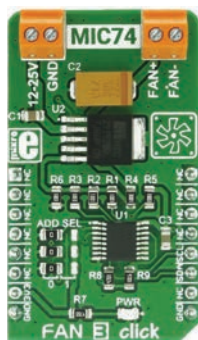

Fan 3 Click

5V | 3.3V | SPI | I2C

UART | GPIO | PWM | AN

Perfect solution for speed control. It can operate in seven discrete speed steps.

MSRP – \$17⁹⁰
MIKROE-2841



Vibro Motor Click

5V | 3.3V | SPI | I2C

UART | GPIO | PWM | AN

Features a compact size Eccentric Rotating Mass (ERM) motor, labeled as C1026B002F.

MSRP – \$12⁰⁰
MIKROE-2826

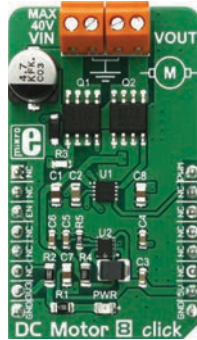

DC Motor 8 Click

5V | 3.3V | SPI | I2C

UART | GPIO | PWM | AN

The MIC4605, 85V half-bridge MOSFET driver with adaptive dead time and shoot-through protection.

MSRP – \$18⁰⁰
MIKROE-2893

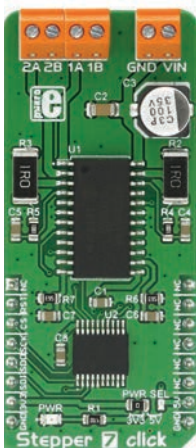

Stepper 7 Click

5V | 3.3V | SPI | I2C

UART | GPIO | PWM | AN

MTS62C19A Dual Full-Bridge Motor Driver, MCP23S08 8bit I/O Expander with Serial Interface.

MSRP – \$17⁰⁰
MIKROE-2912



H-Bridge Click

5V | 3.3V | SPI | I2C

UART | GPIO | PWM | AN

Uses the MC34933, a dual H-bridge driver, from NXP.

MSRP – \$16⁰⁰
MIKROE-3031

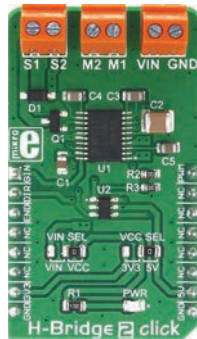

H-Bridge 2 Click

5V | 3.3V | SPI | I2C

UART | GPIO | PWM | AN

Uses the MPC17510, an H-Bridge DC motor driver, with up to 15V and 1.2A, from NXP.

MSRP – \$18⁰⁰
MIKROE-3000

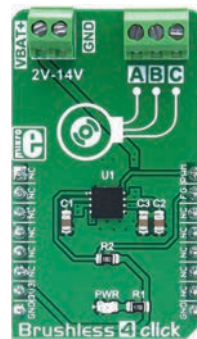

Brushless 4 Click

5V | 3.3V | SPI | I2C

UART | GPIO | PWM | AN

The MCP8063, a 3 phase brushless sinusoidal sensorless motor driver, from Microchip.

MSRP – \$19⁰⁰
MIKROE-3019

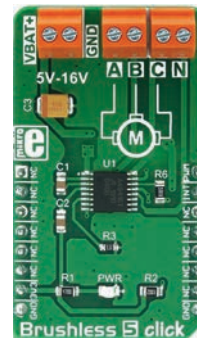

Brushless 5 Click

5V | 3.3V | SPI | I2C

UART | GPIO | PWM | AN

Uses the A4941, a three-phase sensorless fan driver IC, made by Allegro MicroSystems LLC.

MSRP – \$19⁰⁰
MIKROE-3032

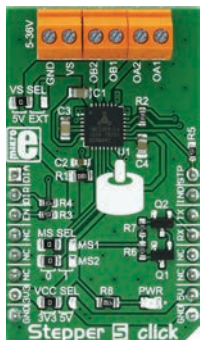

Stepper 5 Click

5V | 3.3V | SPI | I2C
 UART | GPIO | PWM | AN

Uses the TM2208, a highly integrated bipolar step motor power driver, with the UART interface.

MSRP – \$17⁰⁰
 MIKROE-2624



Driver Click

5V | 3.3V | SPI | I2C
 UART | GPIO | PWM | AN

The DRV777, an integrated motor and relay driver from Texas Instruments.

MSRP – \$13⁰⁰
 MIKROE-3109

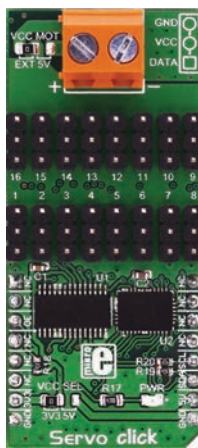

Servo Click

5V | 3.3V | SPI | I2C
 UART | GPIO | PWM | AN

A 16-channel PWM servo driver with the voltage sensing circuitry.

MSRP – \$25⁰⁰
 MIKROE-3133

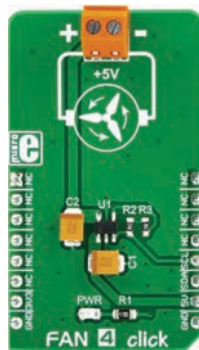

FAN 4 Click

5V | 3.3V | SPI | I2C
 UART | GPIO | PWM | AN

A two-wire fan driver. Utilizes the LTC1695, an I2C fan speed controller.

MSRP – \$15⁰⁰
 MIKROE-3200

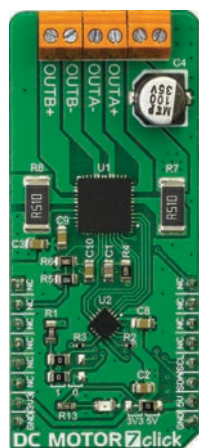

DC MOTOR 7 Click

5V | 3.3V | SPI | I2C
 UART | GPIO | PWM | AN

Advanced PWM chopper-type integrated DC motor driver, labeled as TB67H400AFTG.

MSRP – \$19⁰⁰
 MIKROE-3289

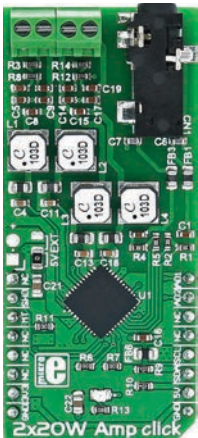

2x20W Amp Click

5V 3.3V SPI I2C

UART GPIO PWM AN

Carries MAX9744 stereo class D audio power amplifier from Maxim Integrated.

MSRP – \$21⁰⁰
MIKROE-2779



2x5W AMP Click

5V 3.3V SPI I2C

UART GPIO PWM AN

Functions as an amplifier. With TDA7491LP 2x5-watt dual BTL class-D audio amplifier.

MSRP – \$19⁰⁰
MIKROE-2477



AudioAmp Click

5V 3.3V SPI I2C

UART GPIO PWM AN

A mono audio amplifier. With TI's LM48100Q-Q1 Boomer™ Mono, 1.3W Audio Power Amplifier IC.

MSRP – \$14⁰⁰
MIKROE-2368



BUZZ Click

5V 3.3V SPI I2C

UART GPIO PWM AN

Features a piezo speaker capable of emitting audio signals. Resonant frequency 3.8 kHz.

MSRP – \$9⁰⁰
MIKROE-945

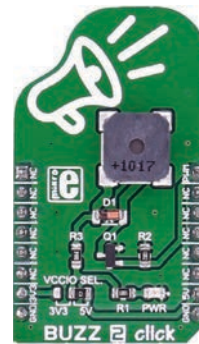

BUZZ 2 Click

5V 3.3V SPI I2C

UART GPIO PWM AN

With CMT-8540S-SMT magnetic buzzer transducer. The buzzer's resonant frequency is 4 kHz.

MSRP – \$12⁰⁰
MIKROE-2720

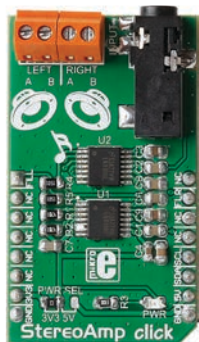

StereoAmp Click

5V | 3.3V | SPI | I2C

UART | GPIO | PWM | AN

With 2 TI's LM48100Q-1 Boomer™ single supply, mono, bridge-tied load amplifier ICs.

MSRP – \$24⁰⁰
MIKROE-2454

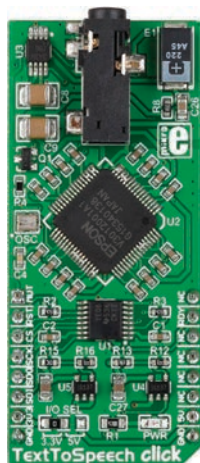

TextToSpeech Click

5V | 3.3V | SPI | I2C

UART | GPIO | PWM | AN

With S1V30120 speech synthesis IC powered by the Fonix DECTalk® v5 speech synthesis engine.

MSRP – \$39⁰⁰
MIKROE-2253

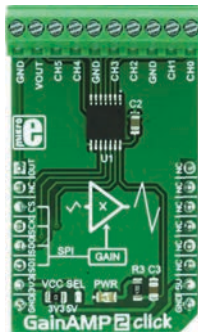

GainAMP 2 Click

5V | 3.3V | SPI | I2C

UART | GPIO | PWM | AN

A 6-channel program-mable gain amplifier. Amplifies up to 32x, in eight discrete steps.

MSRP – \$15⁰⁰
MIKROE-2859



RadioStation Click

5V | 3.3V | SPI | I2C

UART | GPIO | PWM | AN

With the Si4713-B30, the best in class integrated FM broadcast stereo transmitter.

MSRP – \$25⁰⁰
MIKROE-2822

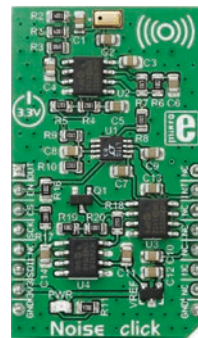

Noise Click

5V | 3.3V | SPI | I2C

UART | GPIO | PWM | AN

With noise detecting circuitry. Enables you to set a noise detection threshold.

MSRP – \$29⁰⁰
MIKROE-2371

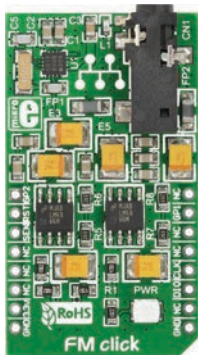

FM Click

5V | 3.3V | SPI | I2C
 UART | GPIO | PWM | AN

Features Si4703 IC and functions as a FM radio tuner. Supports worldwide FM band [76–108 MHz].

MSRP – \$29⁰⁰
 MIKROE-1431

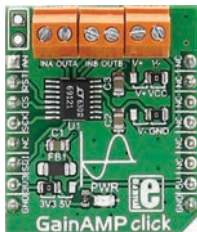

GainAMP Click

5V | 3.3V | SPI | I2C
 UART | GPIO | PWM | AN

Carries LTC[®]6912 dual channel, low noise, digitally programmable gain amplifier (PGA).

MSRP – \$15⁰⁰
 MIKROE-2555

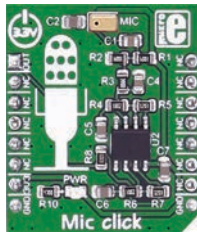

Mic Click

5V | 3.3V | SPI | I2C
 UART | GPIO | PWM | AN

With SPQ410HR5H-B surface mount silicon microphone with max. RF protection.

MSRP – \$9⁰⁰
 MIKROE-2563

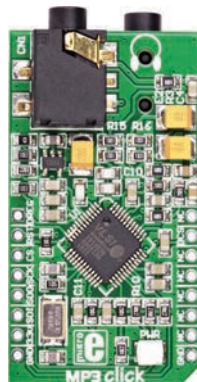

MP3 Click

5V | 3.3V | SPI | I2C
 UART | GPIO | PWM | AN

With a stereo MP3 decoder VS1053. Multiple formats [MP3, MP1, MP2, MPEG4, etc.].

MSRP – \$21⁹⁰
 MIKROE-946



2x30W Amp Click

5V | 3.3V | SPI | I2C
 UART | GPIO | PWM | AN

The TPA3128, 2x30-W class-D amplifier with low idle power dissipation, from TI.

MSRP – \$23⁰⁰
 MIKROE-3010



AudioAmp 2 Click

5V 3.3V SPI I2C
UART GPIO PWM AN

The TDA7491, a 20W dual BTL class-D audio amplifier IC, from STMicroelectronics.

MSRP – \$21⁰⁰
MIKROE-3077

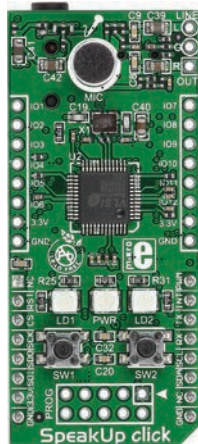

SpeakUp Click

5V 3.3V SPI I2C
UART GPIO PWM AN

A speech recognition Click. Can recognize over 200 different voice commands.

MSRP – \$39⁰⁰
MIKROE-1534



SpeakUp 2 Click

5V 3.3V SPI I2C
UART GPIO PWM AN

A speech recognition Click. Set it up to recognize up to 100 commands.

MSRP – \$34⁰⁰
MIKROE-2375

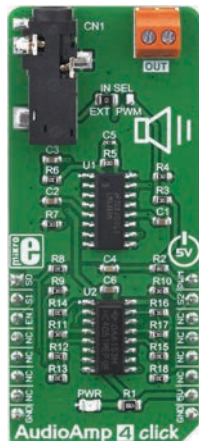

AudioAmp 4 Click

5V 3.3V SPI I2C
UART GPIO PWM AN

With the LM4860, an audio amplifier IC capable of delivering up to 1W of continuous power to an 8 Ω load.

MSRP – \$17⁰⁰
MIKROE-3271

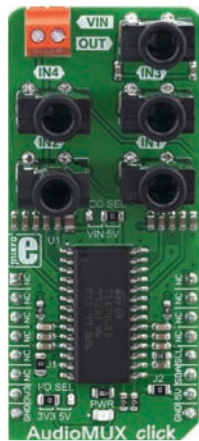

AudioMUX Click

5V 3.3V SPI I2C
UART GPIO PWM AN

Two-band digitally controlled high-quality audio processor with BASS ALC feat. and a 4-channel input selector.

MSRP – \$49⁰⁰
MIKROE-3344

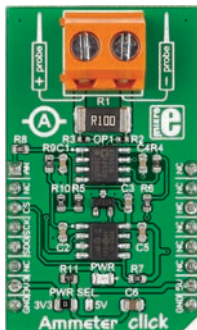

Ammeter Click

5V 3.3V SPI I2C
 UART GPIO PWM AN

With circuitry for measuring electric current (AC and DC), 0.1A-1A measurement range.

MSRP - \$24⁰⁰
 MIKROE-2377

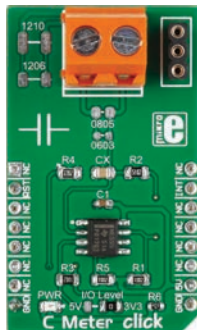

C Meter Click

5V 3.3V SPI I2C
 UART GPIO PWM AN

Circuitry for measuring the value of capacitors. Based on NE-555 timer/square-wave generator.

MSRP - \$9⁰⁰
 MIKROE-2376

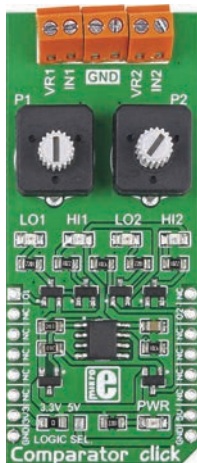

Comparator Click

5V 3.3V SPI I2C
 UART GPIO PWM AN

Carries LM2903 IC, has two independent precision voltage comparators. 2 mV offset voltage.

MSRP - \$12⁰⁰
 MIKROE-1915

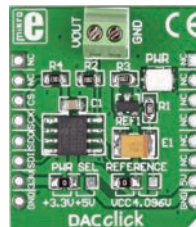

DAC Click

5V 3.3V SPI I2C
 UART GPIO PWM AN

Includes a 12-bit Digital-to-Analog Converter MCP4921 from Microchip.

MSRP - \$18⁰⁰
 MIKROE-950

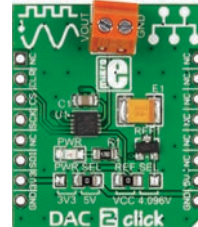

DAC 2 Click

5V 3.3V SPI I2C
 UART GPIO PWM AN

Carries LTC2601CDD, a 16-bit digital-to-analog converter from Linear Technology.

MSRP - \$19⁰⁰
 MIKROE-1918

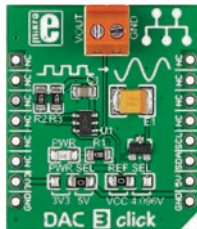

DAC 3 Click

5V 3.3V SPI I2C
UART GPIO PWM AN

Carries Microchip's MCP4726 IC, a 12-bit digital-to-analog converter.

MSRP – \$18⁰⁰
MIKROE-2038

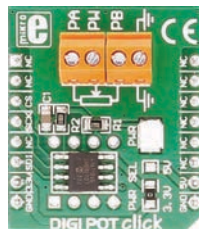

DIGI POT Click

5V 3.3V SPI I2C
UART GPIO PWM AN

Carries MCP416 single-channel 8-bit resolution [256 wiper steps] digital potentiometer.

MSRP – \$16⁹⁰
MIKROE-923

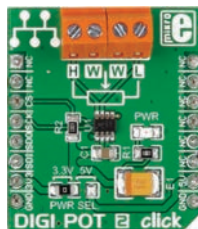

DIGI POT 2 Click

5V 3.3V SPI I2C
UART GPIO PWM AN

Carries a single channel digital potentiometer TPL0501 with 256 wiper positions.

MSRP – \$16⁹⁰
MIKROE-2332

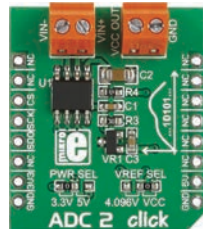

ADC 2 Click

5V 3.3V SPI I2C
UART GPIO PWM AN

With MCP3551/3, a 22-bit ADC with automatic internal offset and gain calibration.

MSRP – \$24⁰⁰
MIKROE-1893

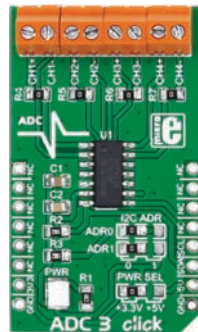

ADC 3 Click

5V 3.3V SPI I2C
UART GPIO PWM AN

With Microchip's MCP3428 16-bit multichannel analog-to-digital converter.

MSRP – \$22⁰⁰
MIKROE-1894



R Meter Click

5V 3.3V SPI I2C

UART GPIO PWM AN

With circuitry for measuring the value of resistors. A wide range of resistors [0-1 Mega Ohm].

MSRP – \$27⁰⁰
MIKROE-2396

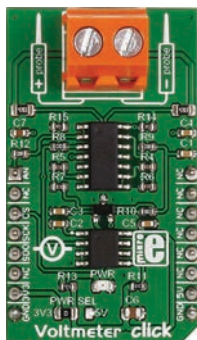

Voltmeter Click

5V 3.3V SPI I2C

UART GPIO PWM AN

For measuring voltage in an external electric circuit. Measures direct current [from 0 to 24V].

MSRP – \$24⁰⁰
MIKROE-2436



ADC 4 Click

5V 3.3V SPI I2C

UART GPIO PWM AN

An advanced analog to digital multichannel converter. It can work in 16bit or 24bit mode.

MSRP – \$65⁰⁰
MIKROE-2879

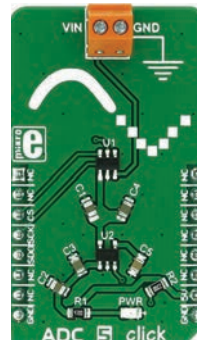

ADC 5 Click

5V 3.3V SPI I2C

UART GPIO PWM AN

With a low power, single channel 12-bit CMOS analog to digital converter.

MSRP – \$18⁰⁰
MIKROE-2846

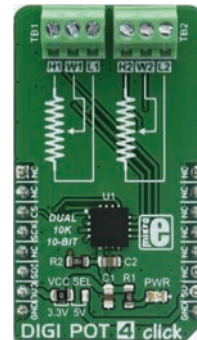

DIGI POT 4 Click

5V 3.3V SPI I2C

UART GPIO PWM AN

A digitally controlled dual potentiometer, with the resistance of 10KΩ.

MSRP – \$21⁰⁰
MIKROE-2873

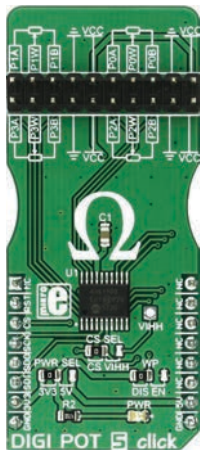

DIGI POT 5 Click

5V 3.3V SPI I2C
UART GPIO PWM AN

A digitally controlled quad potentiometer, with the resistance of 10KΩ.

MSRP – \$16⁹⁰
MIKROE-2863

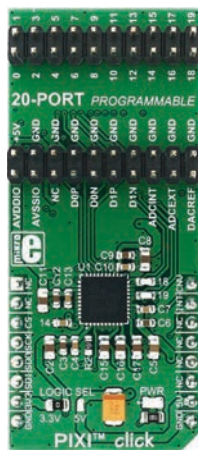

PIXI™ Click

5V 3.3V SPI I2C
UART GPIO PWM AN

Features proprietary PIXI™ technology. Configurable 20-channel mixed-signal data converter.

MSRP – \$29⁰⁰
MIKROE-2817



Slider Click

5V 3.3V SPI I2C
UART GPIO PWM AN

Features a mechanical slide action potentiometer.

MSRP – \$24⁰⁰
MIKROE-2702



LEM Click

5V 3.3V SPI I2C
UART GPIO PWM AN

Measures AC and DC current (up to 200 KHz). With LTS 6-NP current transducer.

MSRP – \$59⁰⁰
MIKROE-2553

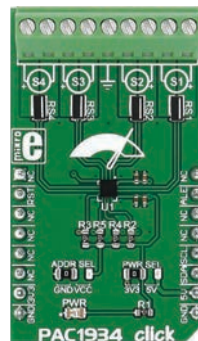

PAC1934 Click

5V 3.3V SPI I2C
UART GPIO PWM AN

Carries PAC1934 four channel DC power/energy monitor from Microchip.

MSRP – \$29⁰⁰
MIKROE-2735

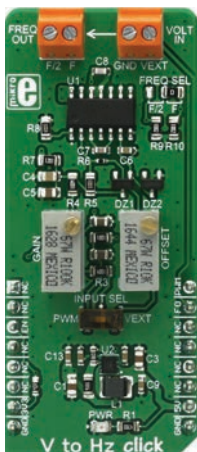

V to Hz Click

5V | 3.3V | SPI | I2C
 UART | GPIO | PWM | AN

The TC9400, a voltage-to-frequency and frequency-to-voltage converter from Microchip.

MSRP - \$27⁰⁰
 MIKROE-2889

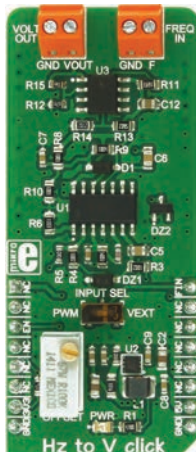

Hz to V Click

5V | 3.3V | SPI | I2C
 UART | GPIO | PWM | AN

The TC9400, a voltage-to-frequency and frequency-to-voltage converter from Microchip.

MSRP - \$27⁰⁰
 MIKROE-2890

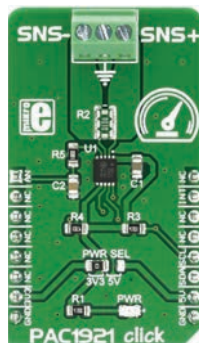

PAC1921 Click

5V | 3.3V | SPI | I2C
 UART | GPIO | PWM | AN

The PAC1921, a high side power/current monitor from Microchip.

MSRP - \$17⁰⁰
 MIKROE-2910

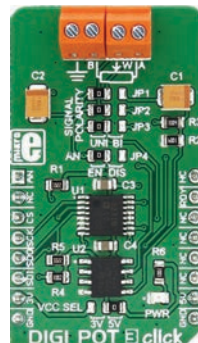

DIGI POT 3 Click

5V | 3.3V | SPI | I2C
 UART | GPIO | PWM | AN

The AD5321, a 1024-position [10bit] digital potentiometer with a non-volatile memory [EEMEM].

MSRP - \$21⁰⁰
 MIKROE-3016



ADC 7 Click

5V | 3.3V | SPI | I2C
 UART | GPIO | PWM | AN

The LTC2500-32. It is a 32-bit oversampling ADC with a configurable digital filter, from Analog Devices.

MSRP - \$99⁰⁰
 MIKROE-3115



Multimeter Click

5V 3.3V SPI I2C
UART GPIO PWM AN

Has different ICs: amplifiers, NE555 timer, BCD decoder, frequency to voltage converter, and an A/D converter [ADC].

MSRP – \$39⁰⁰
MIKROE-3116

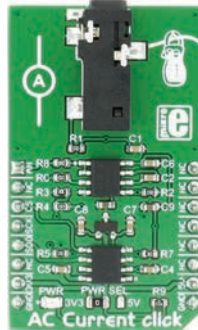

AC Current Click

5V 3.3V SPI I2C
UART GPIO PWM AN

Measure alternating currents up to 30A. MCP3201 ADC converter and MCP607 CMOS Op Amp.

MSRP – \$14⁰⁰
MIKROE-2523

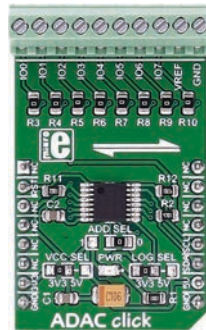

ADAC Click

5V 3.3V SPI I2C
UART GPIO PWM AN

It's an 8-channel 12-bit ADC, DAC and GPIO. With AD593R configurable ADC/DAC.

MSRP – \$26⁰⁰
MIKROE-2690

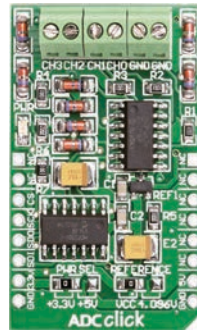

ADC Click

5V 3.3V SPI I2C
UART GPIO PWM AN

With Microchip's MCP3204 12-bit Analog-to-Digital converter.

MSRP – \$24⁰⁰
MIKROE-922

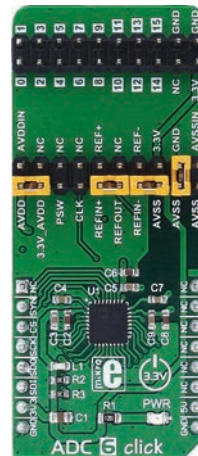

ADC 6 Click

5V 3.3V SPI I2C
UART GPIO PWM AN

With the AD7124-8, an 8 channel, low noise, low power, 24bit sigma-delta ADC.

MSRP – \$29⁰⁰
MIKROE-2932



Hz to V 2 Click

5V | 3.3V | SPI | I2C
UART | GPIO | PWM | AN

With the VFC32KU, a voltage-to-frequency and frequency-to-voltage converter.

MSRP – \$42⁰⁰
MIKROE-3126



V to Hz 2 Click

5V | 3.3V | SPI | I2C
UART | GPIO | PWM | AN

With the VFC32KU, a voltage-to-frequency and frequency-to-voltage converter.

MSRP – \$42⁰⁰
MIKROE-3131



PWR Meter Click

5V | 3.3V | SPI | I2C
UART | GPIO | PWM | AN

Uses the MCP39F511A, a very sophisticated monitoring IC from Microchip, with 16-bit processing core.

MSRP – \$42⁰⁰
MIKROE-3169

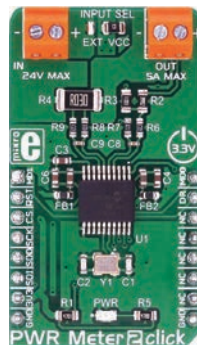

PWR Meter 2 Click

5V | 3.3V | SPI | I2C
UART | GPIO | PWM | AN

Measuring and monitoring voltage up to 24V and current up to 5A. It carries the MCP3910 module.

MSRP – \$19⁰⁰
MIKROE-3150

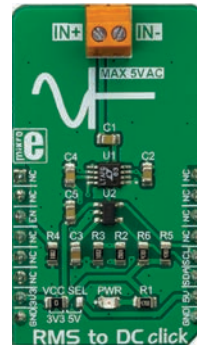

RMS to DC Click

5V | 3.3V | SPI | I2C
UART | GPIO | PWM | AN

With the LTC1968, converter IC, which outputs an analog voltage depending on the RMS value of the input signal.

MSRP – \$35⁰⁰
MIKROE-3111

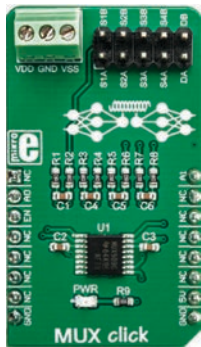

MUX Click

5V | 3.3V | SPI | I2C
 UART | GPIO | PWM | AN

Equipped with the MUX508, a precise analog multiplexing IC.

MSRP – \$17⁰⁰
 MIKROE-3247

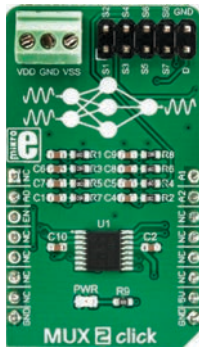

MUX 2 Click

5V | 3.3V | SPI | I2C
 UART | GPIO | PWM | AN

The MUX508, a modern CMOS analog multiplexing integrated circuit.

MSRP – \$17⁰⁰
 MIKROE-3245



Slider 2 Click

5V | 3.3V | SPI | I2C
 UART | GPIO | PWM | AN

Utilizes the PTA3043, a linear, high-grade, 10K potentiometer

MSRP – \$20⁰⁰
 MIKROE-3301

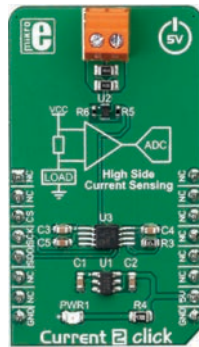

Current 2 Click

5V | 3.3V | SPI | I2C
 UART | GPIO | PWM | AN

Equipped with an integrated transimpedance amplifying circuit.

MSRP – \$17⁰⁰
 MIKROE-3292

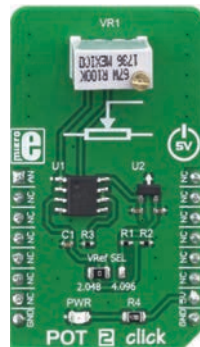

POT 2 Click

5V | 3.3V | SPI | I2C
 UART | GPIO | PWM | AN

The MCP1541, a precision voltage reference IC from Microchip is used to provide the voltage of 4.096V.

MSRP – \$12⁰⁰
 MIKROE-3325



Buck-Boost Click

5V | 3.3V | SPI | I2C
 UART | GPIO | PWM | AN

Features LTC3129-1, a buck-boost DC/DC conversion integrated circuit.

MSRP – \$20⁰⁰
 MIKROE-2806

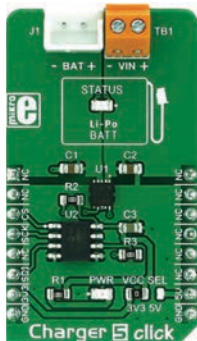

Charger 5 Click

5V | 3.3V | SPI | I2C
 UART | GPIO | PWM | AN

Designed to charge Lithium-Ion and Lithium-Polymer batteries.

MSRP – \$16⁰⁰
 MIKROE-2848

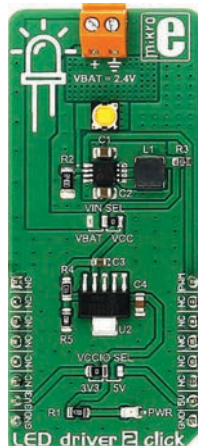

LED driver 2 Click

5V | 3.3V | SPI | I2C
 UART | GPIO | PWM | AN

Carries the MCP1643 - LED constant current regulator, made by Microchip.

MSRP – \$15⁰⁰
 MIKROE-2807

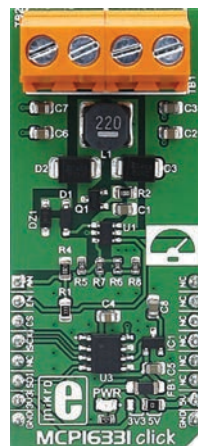

MCP16331 Click

5V | 3.3V | SPI | I2C
 UART | GPIO | PWM | AN

Functions as a non-inverting buck-boost voltage regulator.

MSRP – \$22⁰⁰
 MIKROE-2762

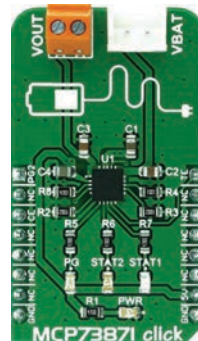

MCP73871 Click

5V | 3.3V | SPI | I2C
 UART | GPIO | PWM | AN

Integrated solution for system power delivery and Li-Po/Li-Ion battery charge management.

MSRP – \$16⁰⁰
 MIKROE-2858

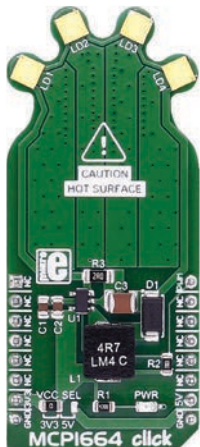

MCP1664 Click

5V 3.3V SPI I2C
UART GPIO PWM AN

With 4 high-power white LEDs. Carries Microchip's MCP1664, a high-voltage step-up LED driver.

MSRP – \$26⁰⁰
MIKROE-2548

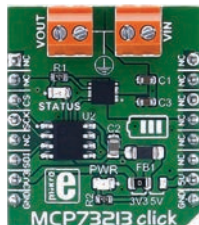

MCP73213 Click

5V 3.3V SPI I2C
UART GPIO PWM AN

Carries MCP73213 dual-cell Li-Ion/Li-Polymer battery charge management controller.

MSRP – \$18⁰⁰
MIKROE-2574



MIC23099 Click

5V 3.3V SPI I2C
UART GPIO PWM AN

Carries MIC23099 single AA/AAA cell step-down/step-up regulator with battery monitoring.

MSRP – \$29⁰⁰
MIKROE-2765

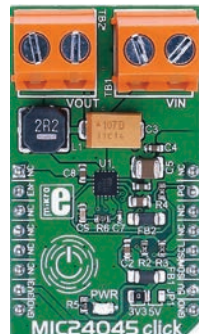

MIC24045 Click

5V 3.3V SPI I2C
UART GPIO PWM AN

Carries MIC24045 5A synchronous step-down regulator. Input range 4.5V-19V.

MSRP – \$13⁰⁰
MIKROE-2574



VREG Click

5V 3.3V SPI I2C
UART GPIO PWM AN

Digitally controlled DC voltage regulator. Based on the well-known LM317 circuit.

MSRP – \$24⁰⁰
MIKROE-2443

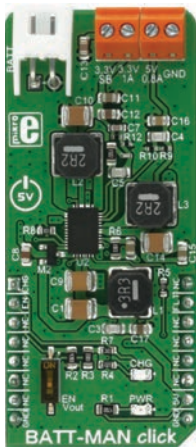

BATT-MAN Click

5V | 3.3V | SPI | I2C

UART | GPIO | PWM | AN

The LTC3586, a high-efficiency power manager with boost, buck-boost, and dual buck converters.

MSRP – \$27⁰⁰
MIKROE-2901

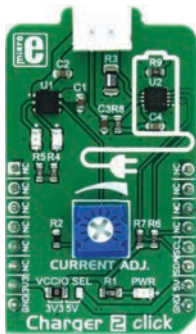

Charger 2 Click

5V | 3.3V | SPI | I2C

UART | GPIO | PWM | AN

The STBC08, an 800 mA standalone linear Li-Ion battery charger with thermal regulation.

MSRP – \$17⁰⁰
MIKROE-3049

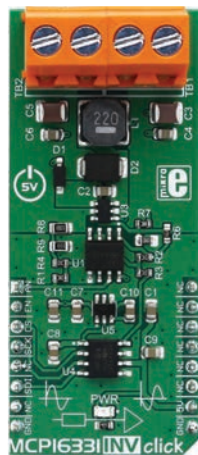

MCP16331 INV Click

5V | 3.3V | SPI | I2C

UART | GPIO | PWM | AN

Works in an inverting configuration, provides a negative output voltage in respect to the GND.

MSRP – \$22⁰⁰
MIKROE-2917

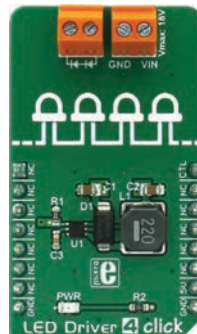

LED Driver 4 Click

5V | 3.3V | SPI | I2C

UART | GPIO | PWM | AN

The TPS61160A, a white LED driver with PWM brightness control.

MSRP – \$15⁰⁰
MIKROE-3037

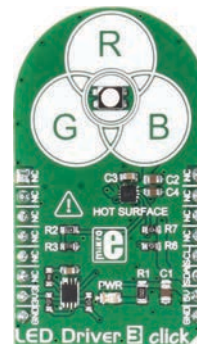

LED Driver 3 Click

5V | 3.3V | SPI | I2C

UART | GPIO | PWM | AN

The NCP5623B, a triple output RGB LED driver, controlled through the I2C protocol.

MSRP – \$15⁰⁰
MIKROE-2950

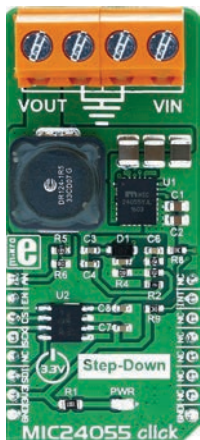

MIC24055 Click

5V | 3.3V | SPI | I2C
 UART | GPIO | PWM | AN

Equipped with the MIC24055, high-efficiency buck regulator from Microchip.

MSRP - \$29⁰⁰
 MIKROE-2835

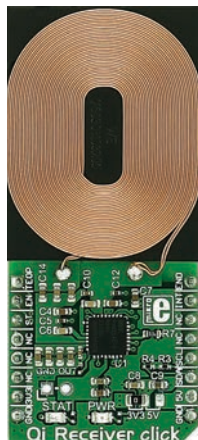

Qi Receiver Click

5V | 3.3V | SPI | I2C
 UART | GPIO | PWM | AN

Utilizes the principles of the inductive coupling for the purpose of wireless power transfer.

MSRP - \$18⁰⁰
 MIKROE-2799

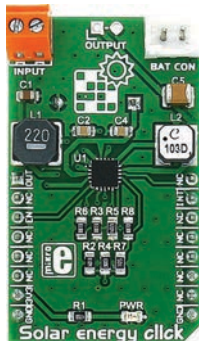

Solar energy Click

5V | 3.3V | SPI | I2C
 UART | GPIO | PWM | AN

Uses TI's BQ25570 - a nano-power high-efficiency boost charger and buck converter device.

MSRP - \$27⁰⁰
 MIKROE-2814

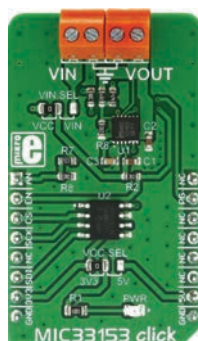

MIC33153 Click

5V | 3.3V | SPI | I2C
 UART | GPIO | PWM | AN

A DC-DC adjustable step-down (buck) converter.

MSRP - \$21⁰⁰
 MIKROE-2887



VREG 2 Click

5V | 3.3V | SPI | I2C
 UART | GPIO | PWM | AN

Uses the LM2596, a 3A, step down voltage regulator working at 150 kHz, from Texas Instruments.

MSRP - \$21⁰⁰
 MIKROE-3055



Buck-Boost 2 Click

5V 3.3V SPI I2C
 UART GPIO PWM AN

The LTC3115-2, a 40V, 2A synchronous buck-boost DC/DC converter from Linear Technology.

MSRP – \$27⁰⁰
 MIKROE-2963

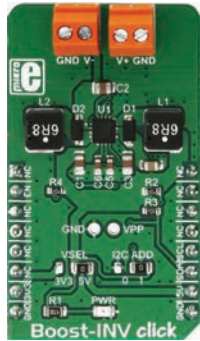

Boost-INV Click

5V 3.3V SPI I2C
 UART GPIO PWM AN

The LTC3582, programmable boost and inverting DC/DC converter with OTP memory.

MSRP – \$21⁰⁰
 MIKROE-3124

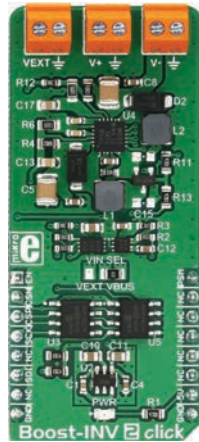

Boost-INV 2 Click

5V 3.3V SPI I2C
 UART GPIO PWM AN

The TPS65131, a positive and negative output DC/DC Converter, from Texas Instruments.

MSRP – \$29⁰⁰
 MIKROE-3123

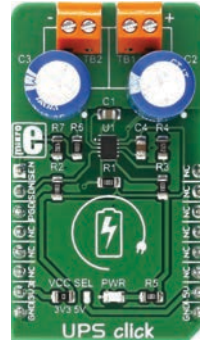

UPS Click

5V 3.3V SPI I2C
 UART GPIO PWM AN

The LTC3225, a 150mA supercapacitor charger from Linear Technology.

MSRP – \$25⁰⁰
 MIKROE-3001

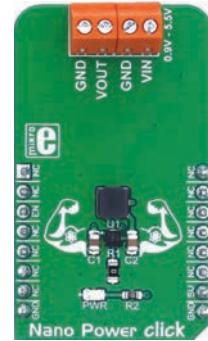

Nano Power Click

5V 3.3V SPI I2C
 UART GPIO PWM AN

The MAX17222 - a nanoPower synchronous boost converter with True Shutdown™ technology.

MSRP – \$11⁰⁰
 MIKROE-3035

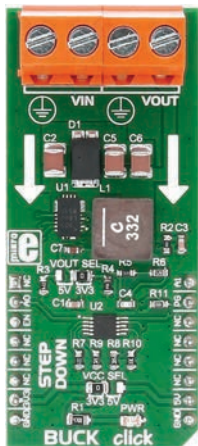

BUCK Click

5V | 3.3V | SPI | I2C
 UART | GPIO | PWM | AN

Buck switching regulator. A wide input voltage range of up to 40V. Steps it down to 3.3V or 5V.

MSRP – \$28⁰⁰
 MIKROE-1592

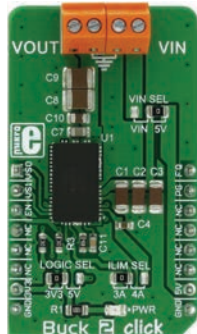

Buck 2 Click

5V | 3.3V | SPI | I2C
 UART | GPIO | PWM | AN

A powerful step down DC-DC switching regulator. Input voltage range 4.5V-19V.

MSRP – \$16⁰⁰
 MIKROE-2858



Buck 3 Click

5V | 3.3V | SPI | I2C
 UART | GPIO | PWM | AN

Uses the TPS568215, a 4.5V to 17V Input, 8A synchronous step-down SWIFT™ converter.

MSRP – \$22⁰⁰
 MIKROE-2971



BUCK 5 Click

5V | 3.3V | SPI | I2C
 UART | GPIO | PWM | AN

The MAX17506, a high efficiency, synchronous step-down DC/DC converter with internal compensation.

MSRP – \$29⁰⁰
 MIKROE-3100

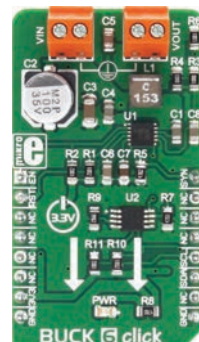

BUCK 6 Click

5V | 3.3V | SPI | I2C
 UART | GPIO | PWM | AN

Uses the MAX17572, a step down [buck] DC-DC converter from Maxim Integrated.

MSRP – \$18⁰⁰
 MIKROE-2957

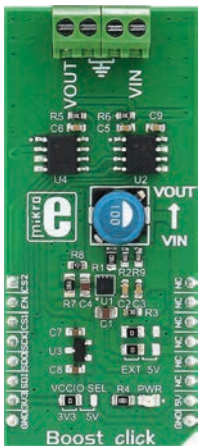

Boost Click

5V | 3.3V | SPI | I2C
 UART | GPIO | PWM | AN

Carries Microchip's MIC2606, a 2MHz, PWM DC/DC boost switching regulator.

MSRP – \$21⁰⁰
 MIKROE-2780

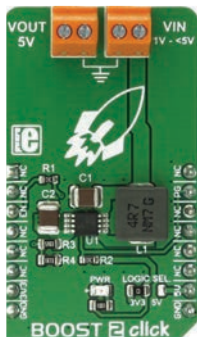

BOOST 2 Click

5V | 3.3V | SPI | I2C
 UART | GPIO | PWM | AN

A DC-DC step-up regulator that has a fixed 5V output.

MSRP – \$15⁰⁰
 MIKROE-2894

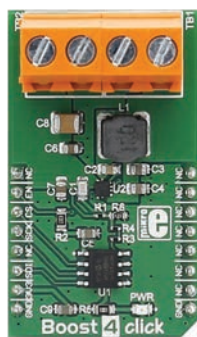

Boost 4 Click

5V | 3.3V | SPI | I2C
 UART | GPIO | PWM | AN

Carries TI's TPS61230A, a high efficiency fully integrated synchronous boost converter.

MSRP – \$17⁰⁰
 MIKROE-2757

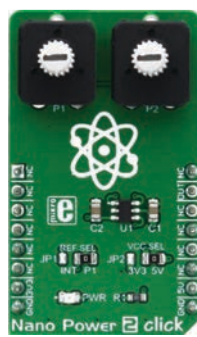

Nano Power 2 Click

5V | 3.3V | SPI | I2C
 UART | GPIO | PWM | AN

The MAX40000AUT12+, a nanoPower comparator with built-in reference.

MSRP – \$11⁰⁰
 MIKROE-3036

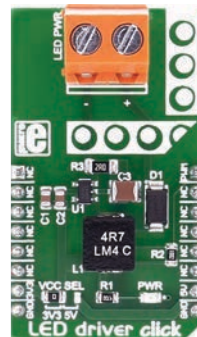

LED driver Click

5V | 3.3V | SPI | I2C
 UART | GPIO | PWM | AN

Carries MCP1662 high-voltage step-up voltage driver from Microchip.

MSRP – \$15⁰⁰
 MIKROE-2676



BUCK 7 Click

5V | 3.3V | SPI | I2C
 UART | GPIO | PWM | AN

The MAX17504, a high efficiency, synchronous step-down DC-DC converter with internal compensation.

MSRP – \$27⁰⁰
 MIKROE-3094



Buck 8 Click

5V | 3.3V | SPI | I2C
 UART | GPIO | PWM | AN

Uses the MAX17536, a high-efficiency, synchronous step-down DC-DC converter.

MSRP – \$26⁰⁰
 MIKROE-2997



Charger Click

5V | 3.3V | SPI | I2C
 UART | GPIO | PWM | AN

Carries a battery charger controller and a battery charge monitor, along with a battery connector.

MSRP – \$22⁰⁰
 MIKROE-2033

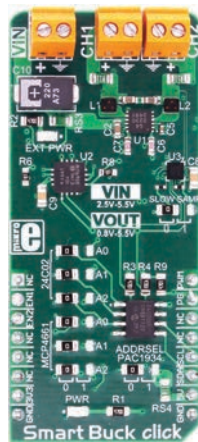

Smart Buck Click

5V | 3.3V | SPI | I2C
 UART | GPIO | PWM | AN

The MIC2230, a dual synchronous step-down DC/DC regulator.

MSRP – \$29⁰⁰
 MIKROE-3113



LED-Driver 5 Click

5V | 3.3V | SPI | I2C
 UART | GPIO | PWM | AN

The TPS54200, a synchronous buck converter designed to drive monochrome, color, and IR LED arrays.

MSRP – \$15⁰⁰
 MIKROE-3297



Buck-Boost 3 Click

5V | 3.3V | SPI | I2C
 UART | GPIO | PWM | AN

The ISL85403, a 2.5A regulator with the integrated high-side MOSFET and a low-side driver.

MSRP - \$27⁰⁰
 MIKROE-3277

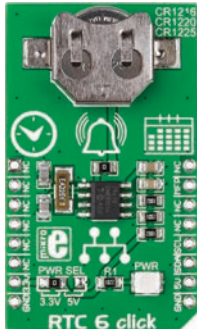

RTC 6 Click

5V | 3.3V | SPI | I2C
 UART | GPIO | PWM | AN

Carries MCP79410 real-time clock/calendar IC. 64 bytes of battery-backed SRAM.

MSRP - \$21⁰⁰
 MIKROE-2063

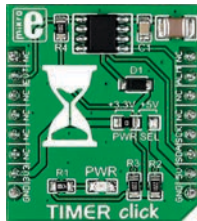

TIMER Click

5V | 3.3V | SPI | I2C
 UART | GPIO | PWM | AN

With DS1682 total elapsed time recorder from Maxim Integrated. ETC used with the ALARM pin.

MSRP - \$18⁰⁰
 MIKROE-2333

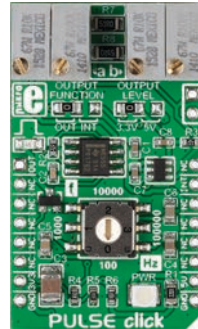

PULSE Click

5V | 3.3V | SPI | I2C
 UART | GPIO | PWM | AN

A pulse generator with precise frequency control. Features NE555 precision timer.

MSRP - \$25⁰⁰
 MIKROE-2032

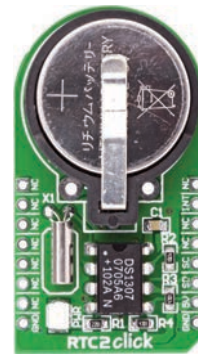

RTC 2 Click

5V | 3.3V | SPI | I2C
 UART | GPIO | PWM | AN

With DS1307 serial real-time clock. It's a full binary-coded decimal [BCD] clock/calendar.

MSRP - \$21⁰⁰
 MIKROE-948

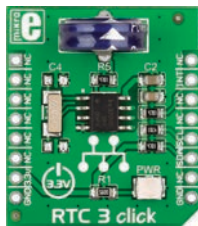

RTC 3 Click

5V | 3.3V | SPI | I2C
 UART | GPIO | PWM | AN

Carries BQ32000, a real time clock with an integrated trickle charge circuit for automatic switchover.

MSRP – \$21⁰⁰
 MIKROE-1839



RTC 4 Click

5V | 3.3V | SPI | I2C
 UART | GPIO | PWM | AN

Carries DS2417, a real time clock/calendar with a 1-Wire MicroLAN interface. 16.3 kbits per second.

MSRP – \$21⁰⁰
 MIKROE-1891

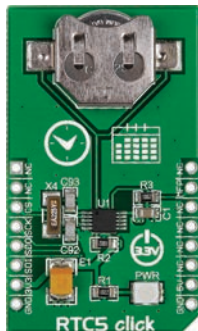

RTC 5 Click

5V | 3.3V | SPI | I2C
 UART | GPIO | PWM | AN

Carries Microchip's MCP79510 real-time clock/calendar.

MSRP – \$21⁰⁰
 MIKROE-1990



PLL Click

5V | 3.3V | SPI | I2C
 UART | GPIO | PWM | AN

The ICS501, a LOCO™ PLL clock multiplier, from Integrated Device Technology.

MSRP – \$15⁰⁰
 MIKROE-2993

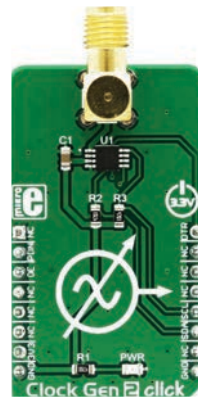

Clock Gen 2 Click

5V | 3.3V | SPI | I2C
 UART | GPIO | PWM | AN

The DS1087LU-266, a 3.3V spread-spectrum EconOscillator, from Maxim Integrated.

MSRP – \$17⁰⁰
 MIKROE-3076

mikroBUS standard

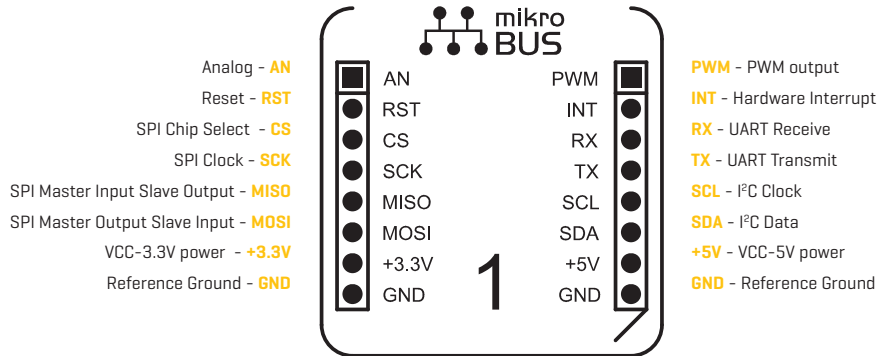

mikroBUS™ is a simple but effective pinout standard containing all the necessary pins to connect all the different Click boards™. There's also a range of mikroBUS™ shields that bring Click board connectivity to all of today's most popular development platforms [Arduino, Raspberry Pi, BeagleBone, Freedom, Discovery, Micro .NET and more].

Clicking on all platforms

Use Click boards™ with your favorite development platform. A range of Shields bring Click connectivity to:

- **Arduino**
- **BeagleBone Black**
- **Raspberry Pi**
- **Freedom**
- **Launchpad**
- **Discovery and more...**

See them all at: www.mikroe.com/Click/shields

mikroBUS Cape

MSRP – \$8⁹⁰
MIKROE-1857



NEW
Click board™
yet to come

NEW
Click board™
yet to come

NEW
Click board™
yet to come

NEW
Click board™
yet to come

NEW
Click board™
yet to come

Even though it was printed recently, the booklet you are holding is probably already outdated. That's because we release new Click boards™ weekly, sometimes daily. For the most current list of Click boards™, visit: www.mikroe.com/click

