

DETAILS

Product Number	FN15379_STELLA-VSM
Family	STELLA
Type	Pack
Color	clear
Diameter	90 mm
Height	20,7 mm
Style	round
Optic Material	Silicone
Holder Material	
Fastening	
Status	production ready
ROHS Compliant	Yes
Date Updated	7/07/2017



OPTICAL PROPERTIES

LED	Viewing Angle	Light Beam	Efficiency	cd/lm	Connector
VERO18	Asymmetric deg	Wide-Area...	94 %	0.400	-
Vero SE 29	Asymmetric deg	Wide-Area...	94 %	0.260	-
Vero SE 13	Asymmetric deg	Wide-Area...	90 %	0.620	-
Vero SE 18	Asymmetric deg	Wide-Area...	94 %	0.370	-
V10 Gen7	sim: Asymmetric	Wide-Area...	sim: 93 %	sim: 0.510	Bender Wirth: 434 Typ Z1
V22 Gen7	Asymmetric deg	Wide-Area...	94 %	0.310	Bender Wirth: 431 Typ Z1
V18 Gen7	Asymmetric deg	Wide-Area...	94 %	0.360	Bender Wirth: 439 Typ L3
V13 Gen7	sim: Asymmetric	Wide-Area...	sim: 97 %	sim: 0.380	Bender Wirth: 477 Typ Z1
V13 Gen7	sim: Asymmetric	Wide-Area...	sim: 98 %	sim: 0.400	-
CLL04x/CLU04x	sim: Asym	Wide-Area...	sim: 93 %	sim: 0.320	-
CLL05x/CLU05x	Asymmetric deg	Wide-Area...	94 %	0.260	-
CLL04x/CLU04x	sim: Asym	Wide-Area...	sim: 94 %	sim: 0.330	Bender Wirth: 431 Typ Z1
CXA/B 30xx	sim: Asymmetric	Wide-Area...	sim: 94 %	sim: 0.300	Bender Wirth: 447 Typ Z1
CXA/B 25xx	sim: Asym	Wide-Area...	sim: 94 %	sim: 0.350	-
LUXEON CoB 1208	Asymmetric deg	Wide-Area...	94 %	0.540	-
LUXEON CoB 1216	sim: Asym	Wide-Area...	sim: 92 %	sim: 0.270	-
CXM-22	sim: Asym	Wide-Area...	sim: 94 %	sim: 0.300	Bender Wirth: 431 Typ Z1
MJT COB LES 33	Asymmetric deg	Wide-Area...	94 %	0.230	-
MJT COB LES 22	Asymmetric deg	Wide-Area...	94 %	0.310	Bender Wirth: 431 Typ Z1
MJT COB LES 14.5	asym deg	Wide-Area...	94 %	0.500	Bender Wirth: 433 Typ Z1

H G F E D C B A

NOTE: Maximum recommended tightening torque for STELLA-FRAME is 0,4Nm

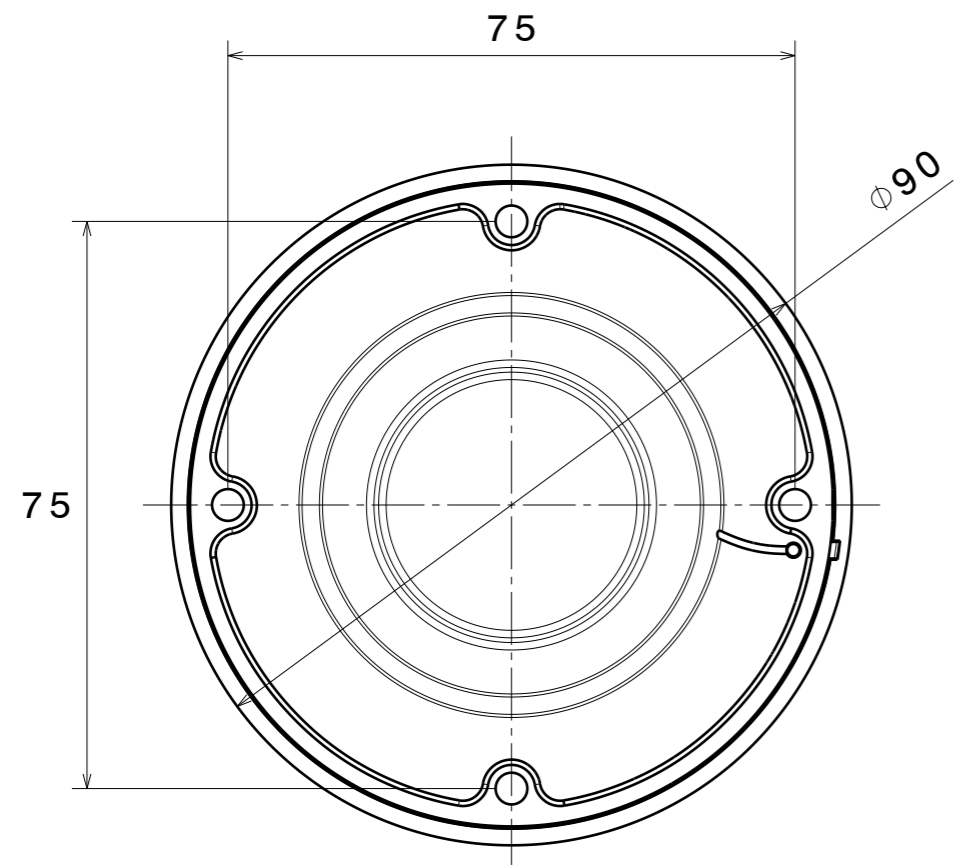

Bottom view

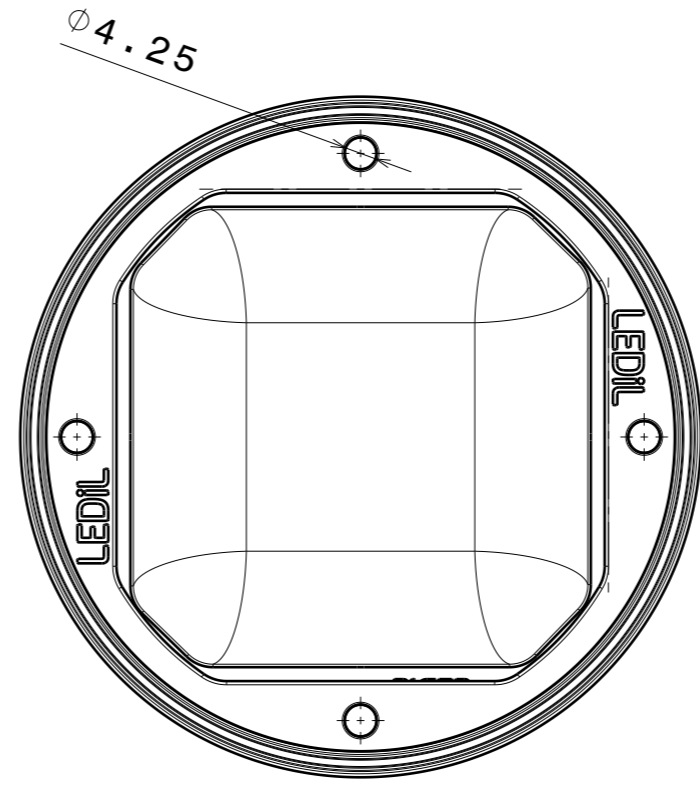

Top view

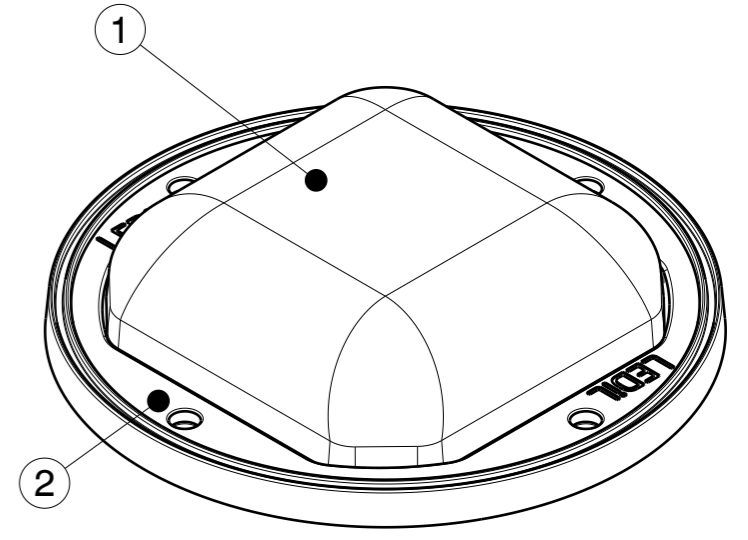

Isometric view

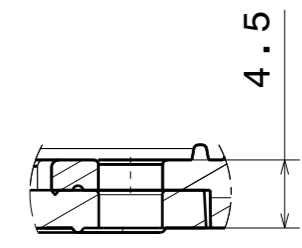

Detail B

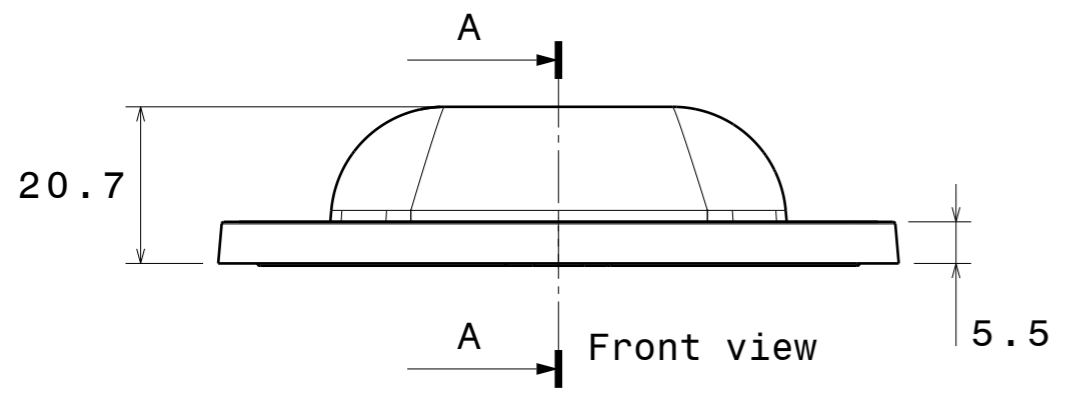

Front view

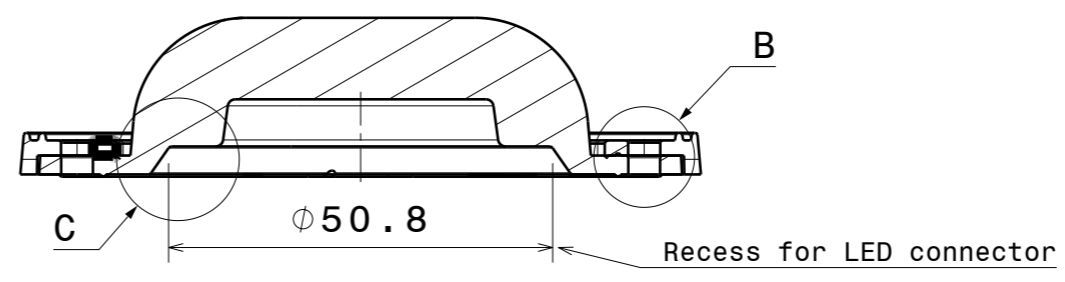

Section view A-A

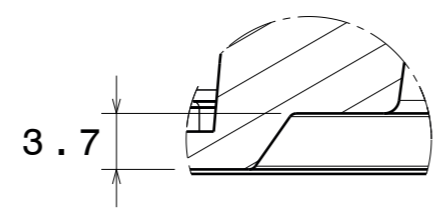

Detail C

INDEX	PART NO	DESCRIPTION	MATERIAL	COLOUR
1	F15175	STELLA-VSM	Optical grade LSR	
2	F13322	STELLA-FRAME	PA66GF30	black

Tolerances if not otherwise shown
 According to DIN ISO 2768-1
 Linear measures:
 Up to 30mm class M, otherwise class C.
 According to DIN ISO 2768-2
 Form and position: class L

LEDiL LediL Oy
 Salorankatu 10
 FIN 24240 SALO
 Finland

THIRD ANGLE PROJECTION:

DRAWING TITLE
FN15379_STELLA-VSM

This drawing is the property of LEDiL Oy. It may not be reproduced, copied or communicated without a written agreement with LEDiL Oy.

SIZE PART NUMBER
A3 FN15379

SCALE 1:1 WEIGHT 58,3 g SHEET 1/1

H G B A

Luminaire: Ledil FN15379_STELLA-VSM_(VERO18)

Lamps: 1 x Bridgelux_Vero18_(BXRE-30E4000-F-23)_1040.57lm@250mA_P=6.7955W_I=0.250A

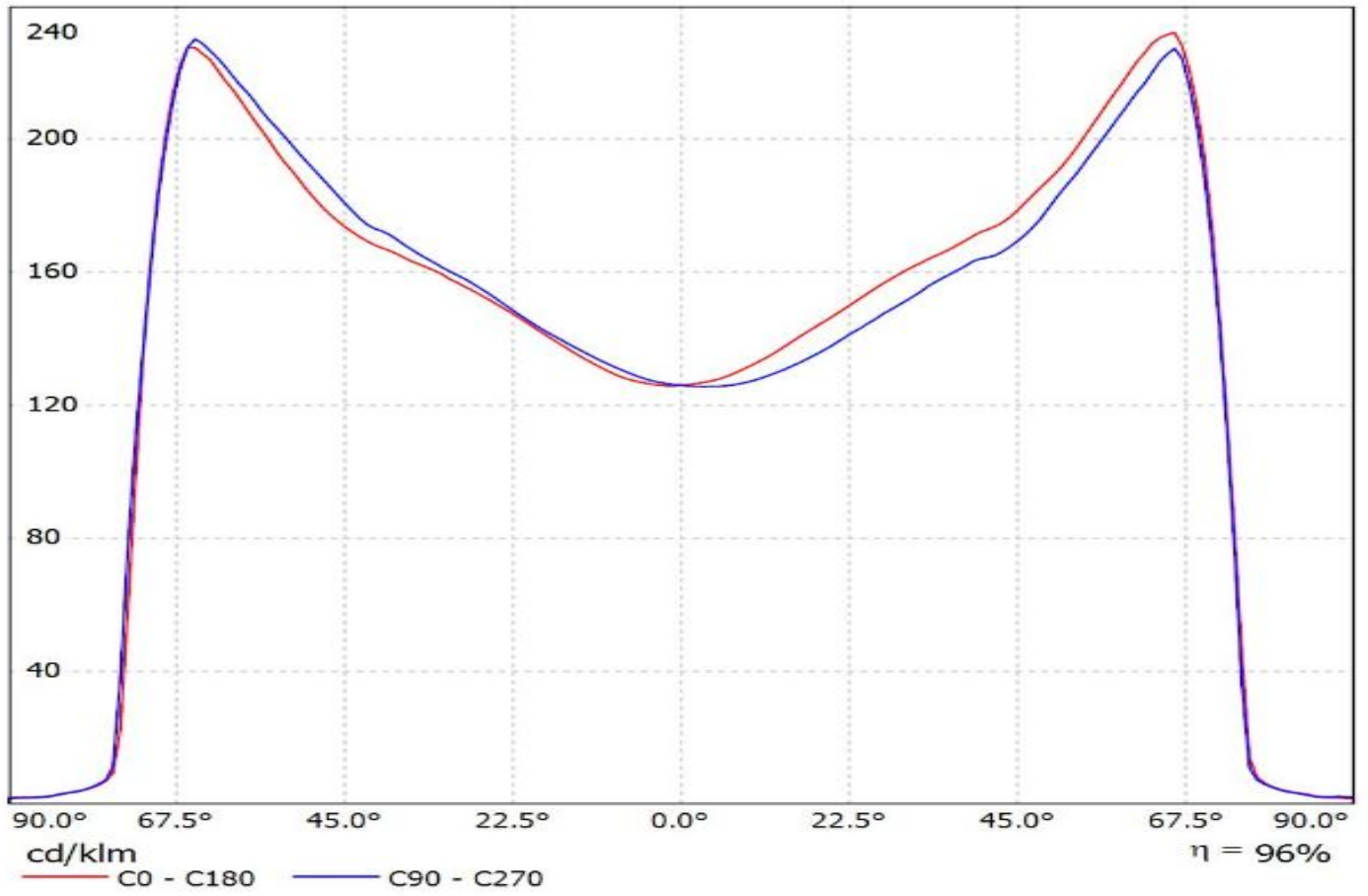

Luminaire: Ledil FN15379_STELLA-VSM_(Vero29_SE_Gen7)
Lamps: 1 x Vero29_SE_Gen7_1759.38lm@250mA_P=8.58975_I=0.25A

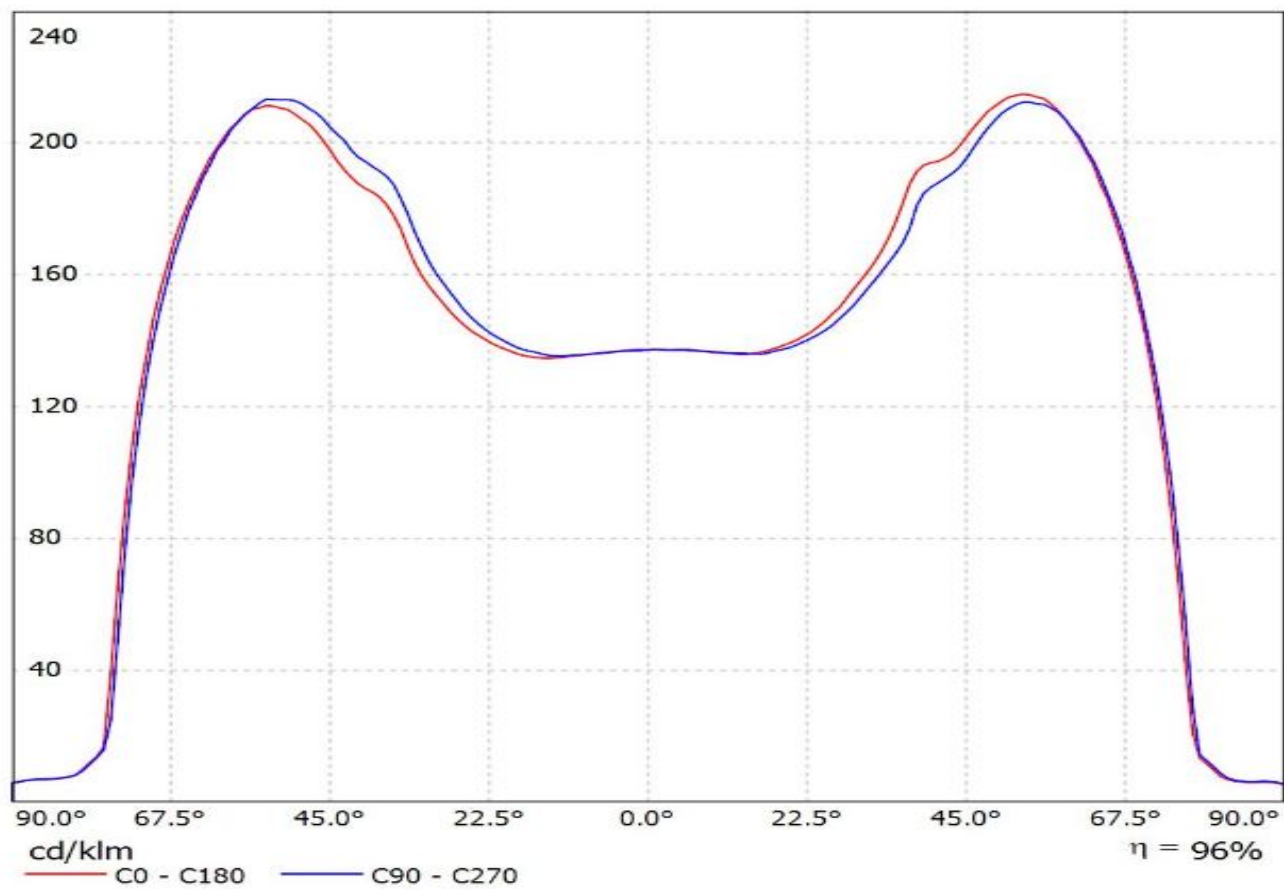

Luminaire: LEDiL Oy FN14976_STELLA-DWC2_(Vero_13_SE)

Lamps: 1 x Bridgelux_Vero_13_SE_(BXRC-30E2000-C-73-SE)_1028.9lm@250mA_CCT=3000K_P=8.23391W_I=0.25A

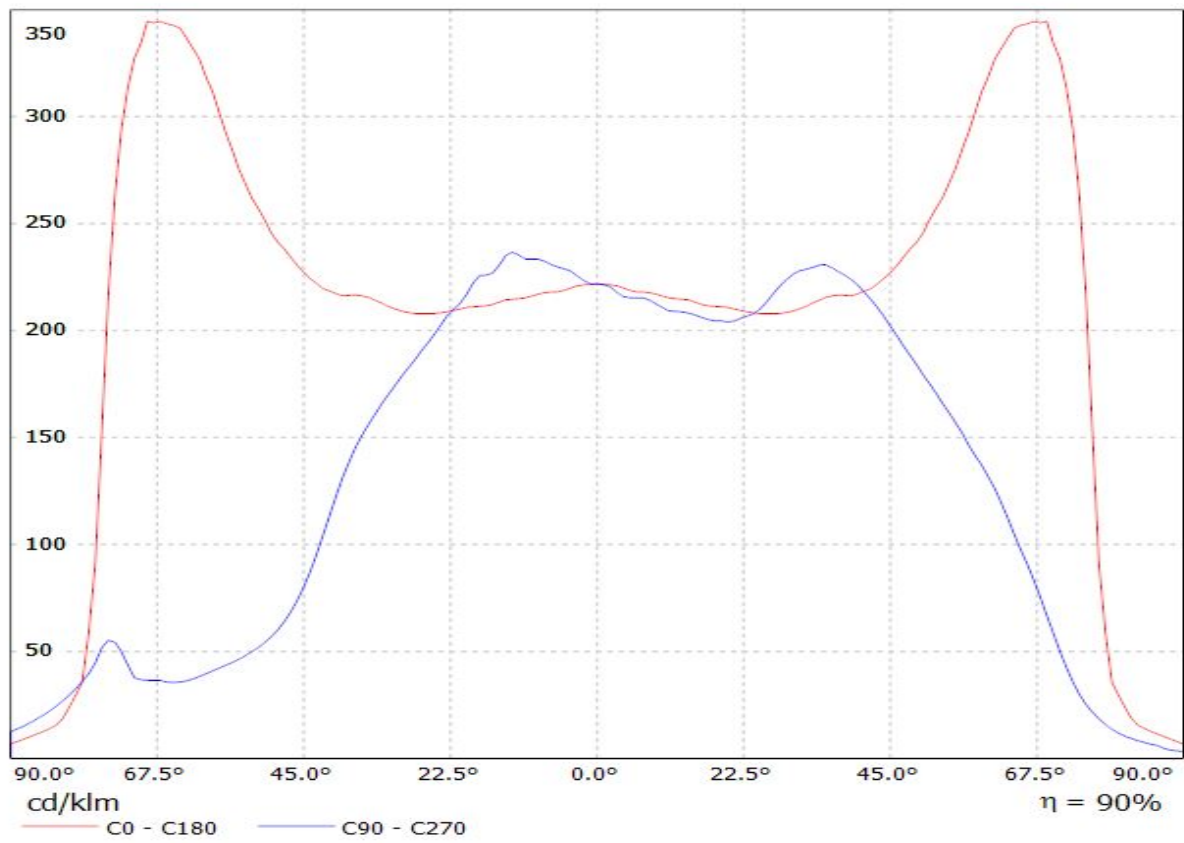

Luminaire: LEDiL Oy FN15379_STELLA-VSM_(VERO18_SE)
Lamps: 1 x Bridgelux_VERO18_SE_(BXRC-30E4000-C-73-SE)
_1335.46lm@250mA_P=7.9961W_I=0.25A

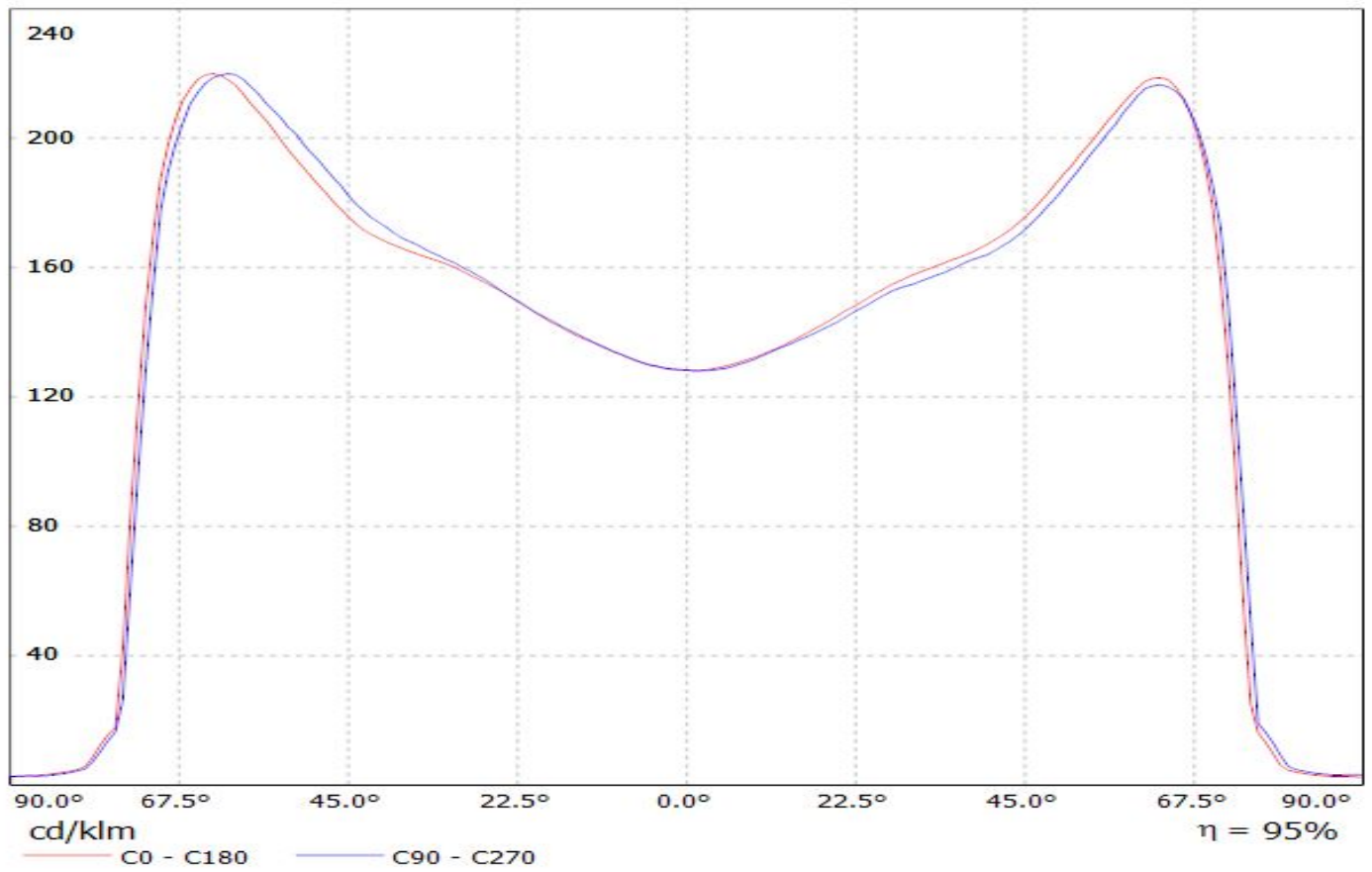

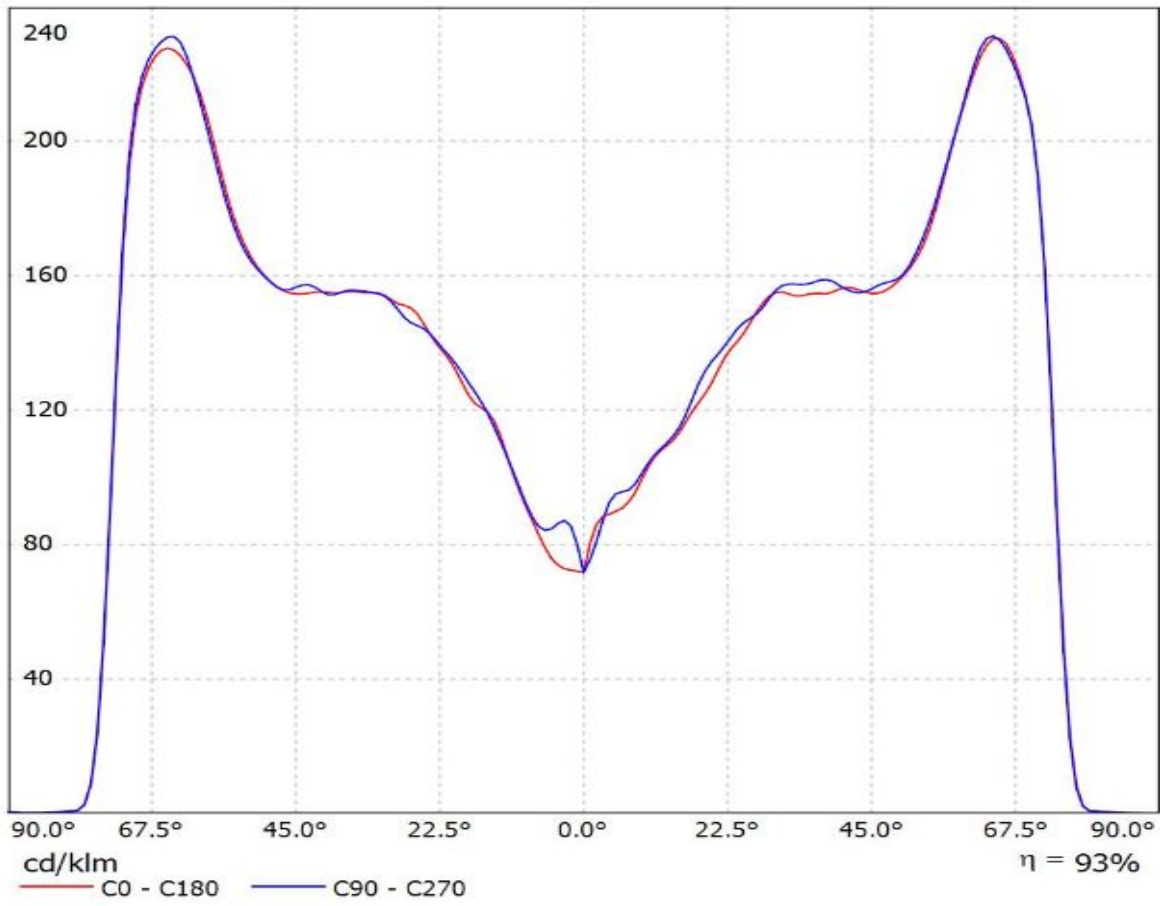

Luminaire: LEDiL Oy FN15379_STELLA-VSM_(V22_Gen7+BW)
Lamps: 1 x Bridgelux_V22_Gen7_(BXRE-30E6500-B)
+BW431_TypZ1_2036.72lm@250mA_P=11.891W_I=0.250A

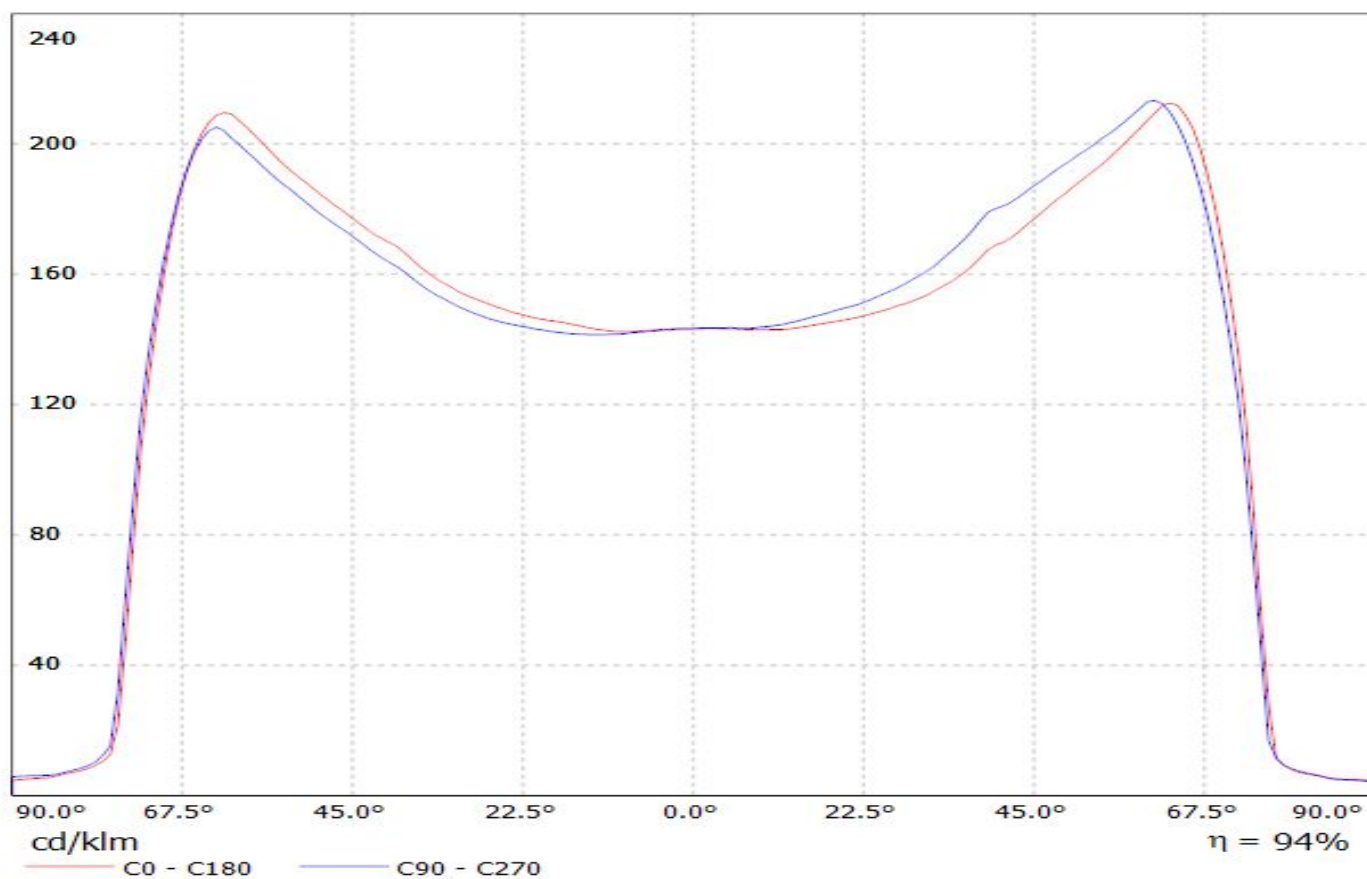

Luminaire: LEDiL Oy FN15379_STELLA-VSM_(V18_Gen7)+BW439_Typ_L3

Lamps: 1 x Bridgelux_V18_Gen7_(BXRE-30E4000-B)+BW439_Typ_L3_1360.58lm@250mA_P=8.07828W_I=0.25A

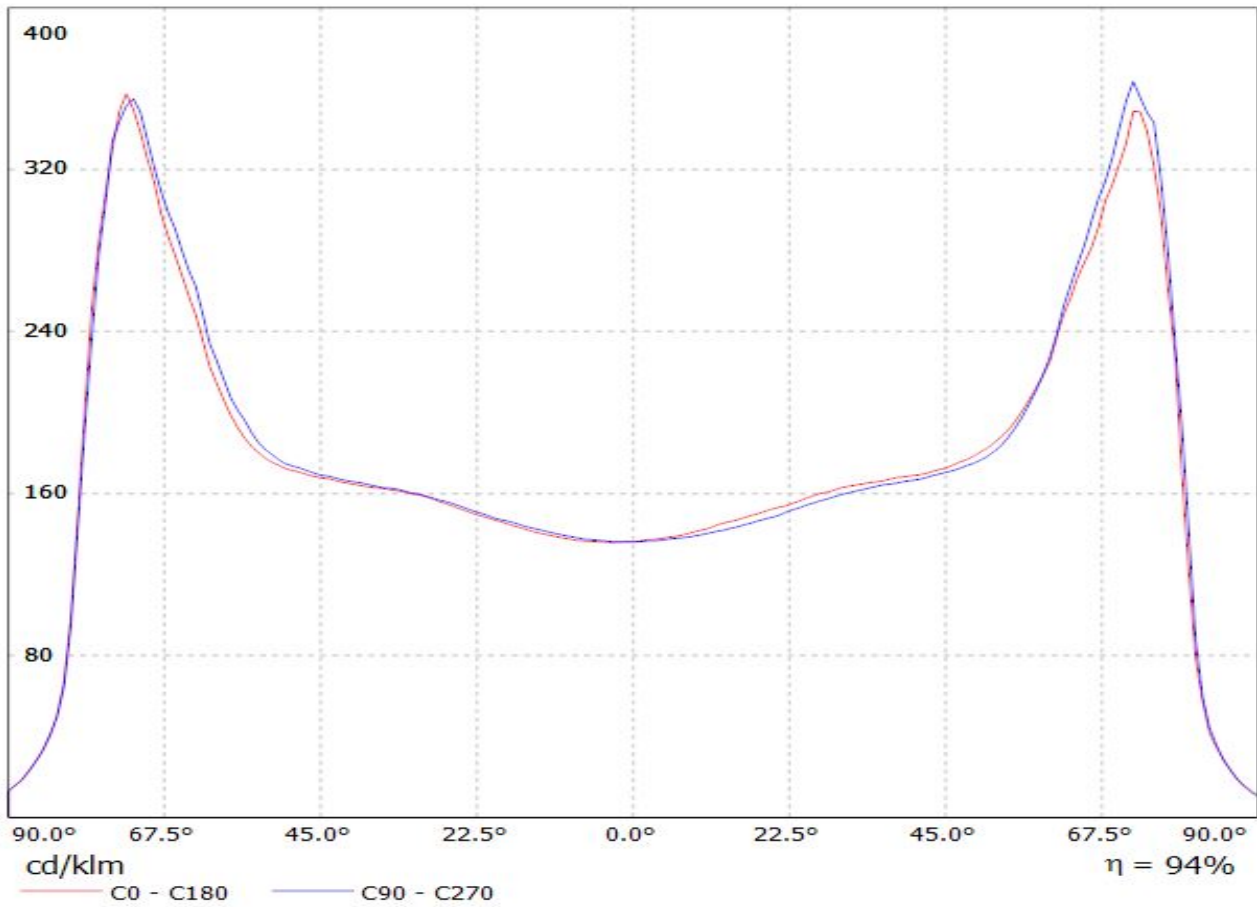

Luminaire: Ledil Oy FN15379_STELLA-VSM_simulated_CLU044
Lamps: 1 x Citizen CLU044

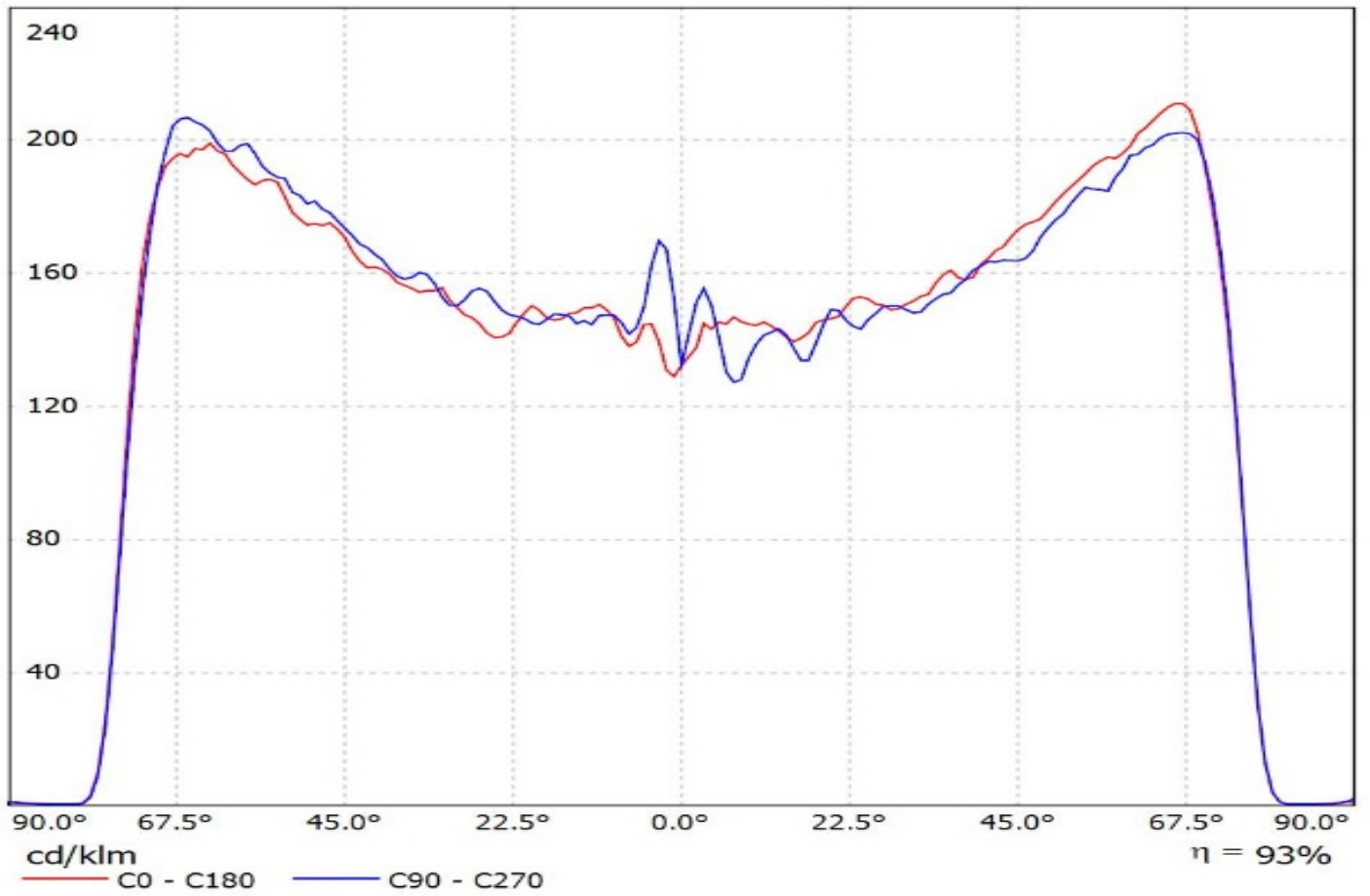

Luminaire: Ledil FN15379_STELLA-VSM_(CLU054)

Lamps: 1 x Citizen_CLU054_(CLU054-1825B8-503MIA2)_1939.14lm@250mA_P=11.752W_η=0.25A

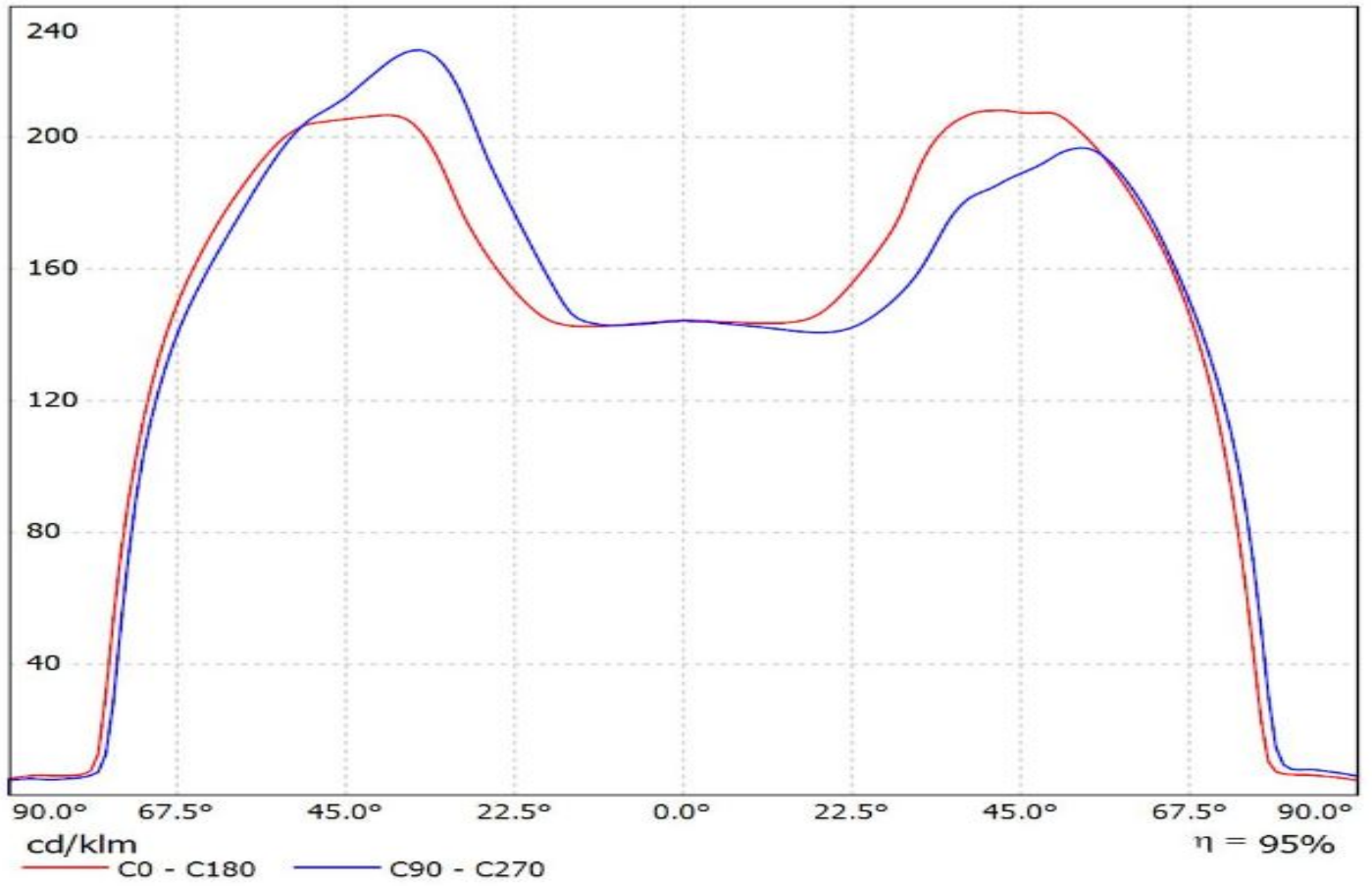

Luminaire: Ledil Oy FN15379_STELLA-VSM_(CLU048)_(B&W_431_Type_Z1)_SIMULATED
Lamps: 1 x Citizen CLU048 + Bender & Wirth 431 Type Z1

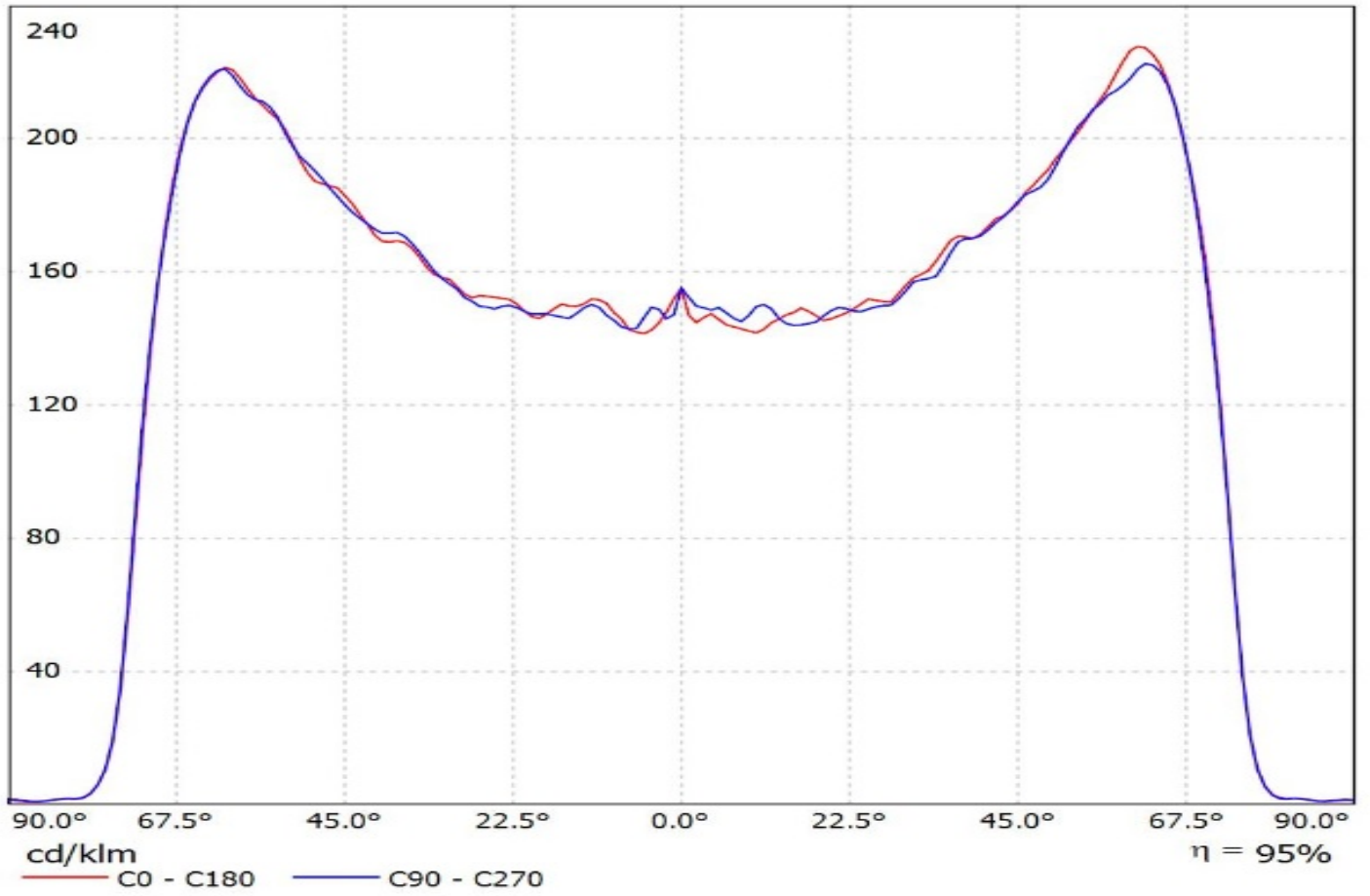

Luminaire: Ledil Oy FN15379_STELLA-VSM+_Bender+Wirth 447 Typ Z1_CREE_CXB3070_SIMULATED
Lamps: 1 x CREE CXB3070

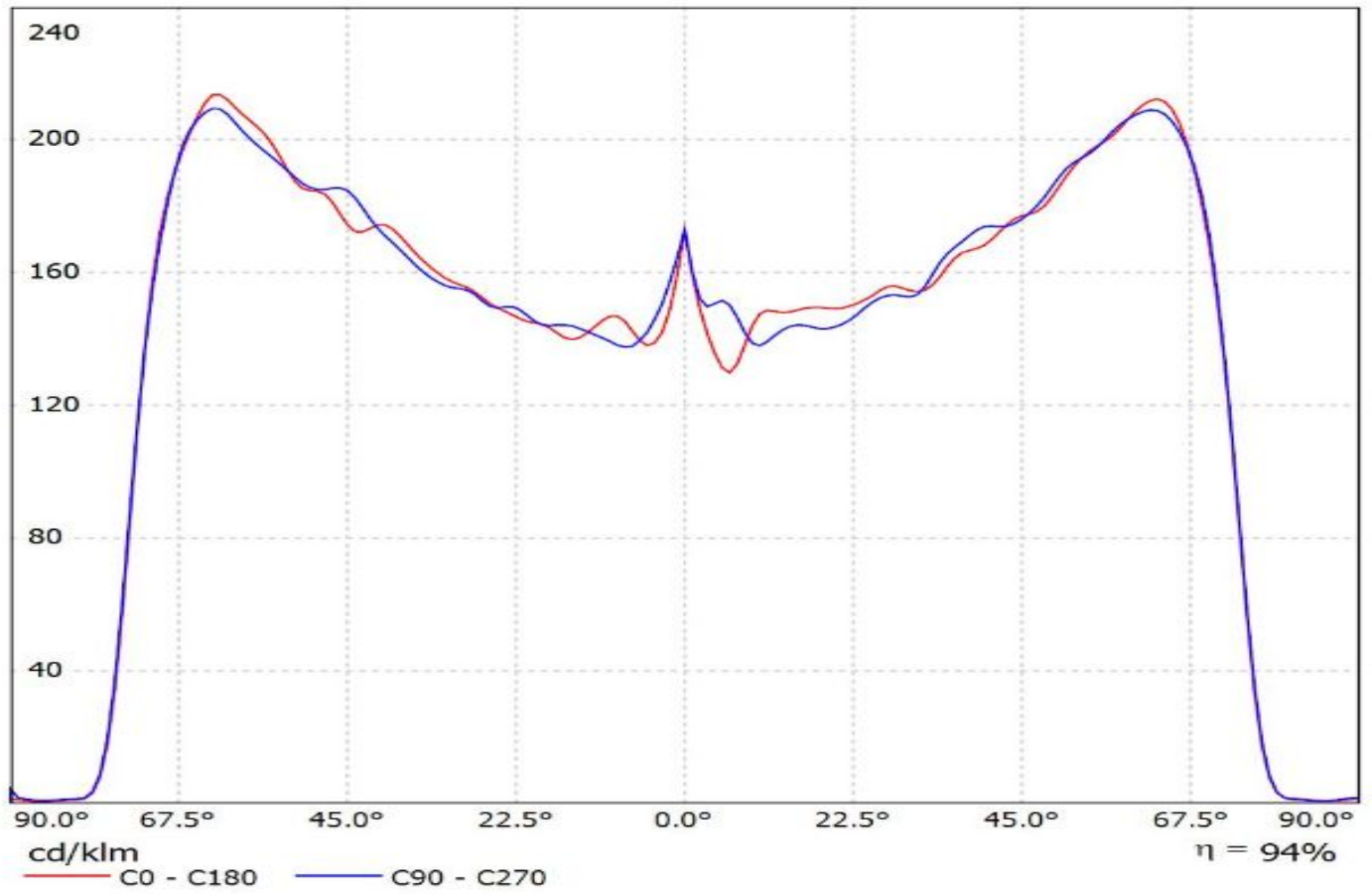

Luminaire: Ledil Oy FN15379_STELLA-VSM_(CXB2540)_SIMULATED
Lamps: 1 x Cree CXB 2540

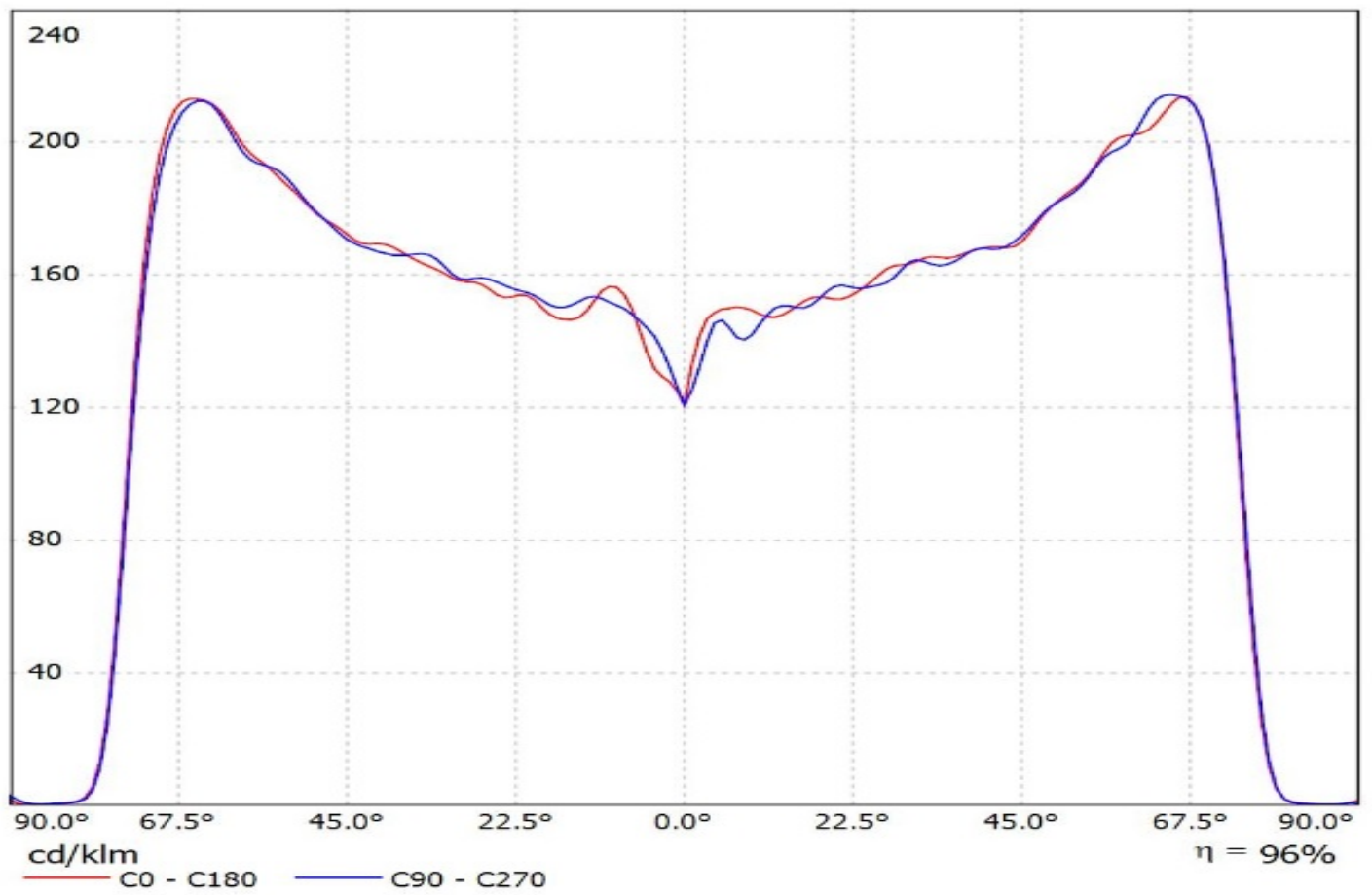

Luminaire: Ledil FN15379_STELLA-VSM_(Luxeon_1208)

Lamps: 1 x Lumileds_Luxeon_1208_(LHC1-3080-1208)_1076.07lm250mA_P=8.2273W_I=0.250A

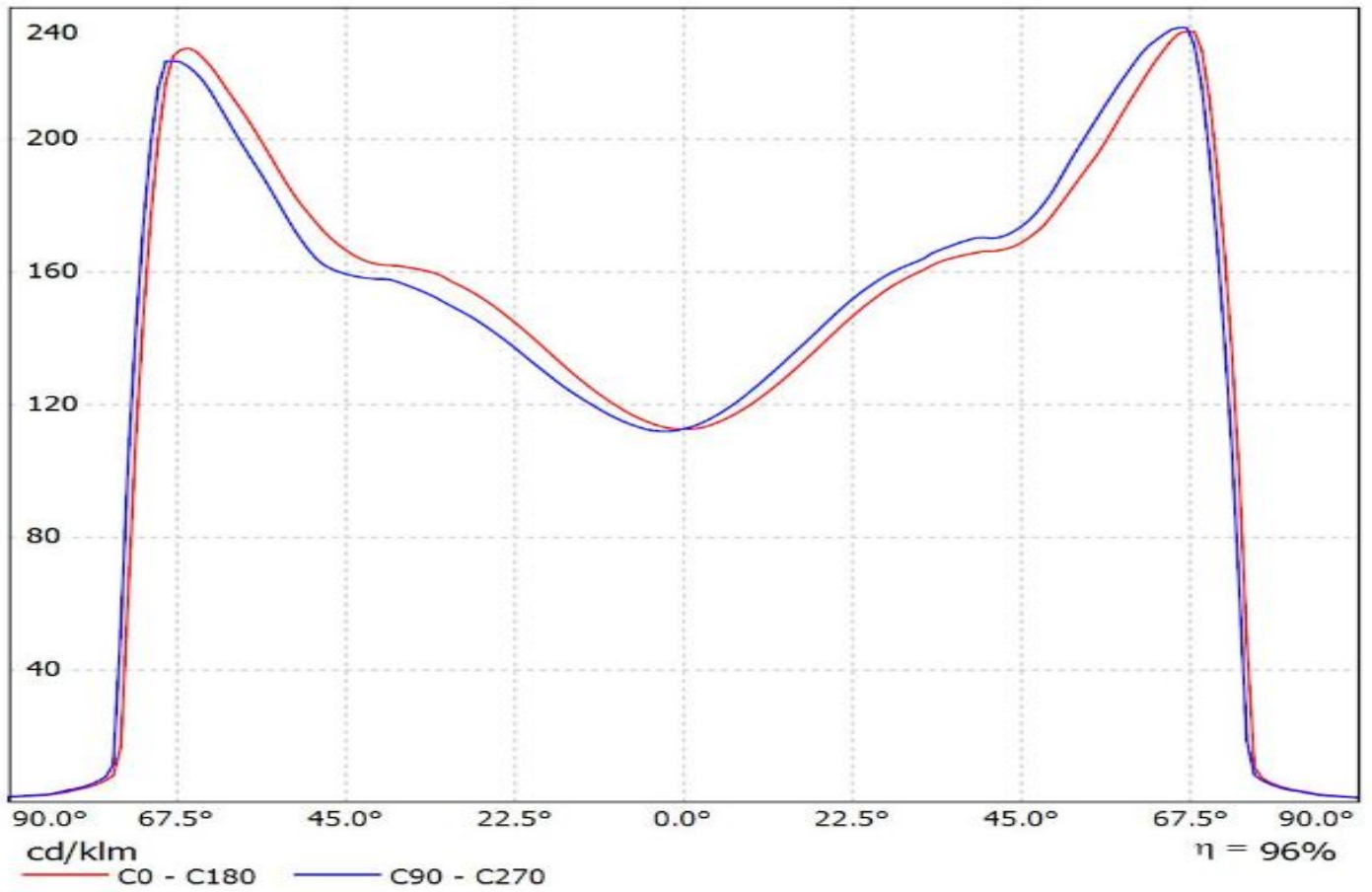

Luminaire: Ledil Oy FN15379_STELLA-VSM_(Luxeon_CoB_1216)_(431_Typ_Z1)_SIMULATED
Lamps: 1 x Lumileds Luxeon CoB 1216 + Bender & Wirth 431 Type Z1

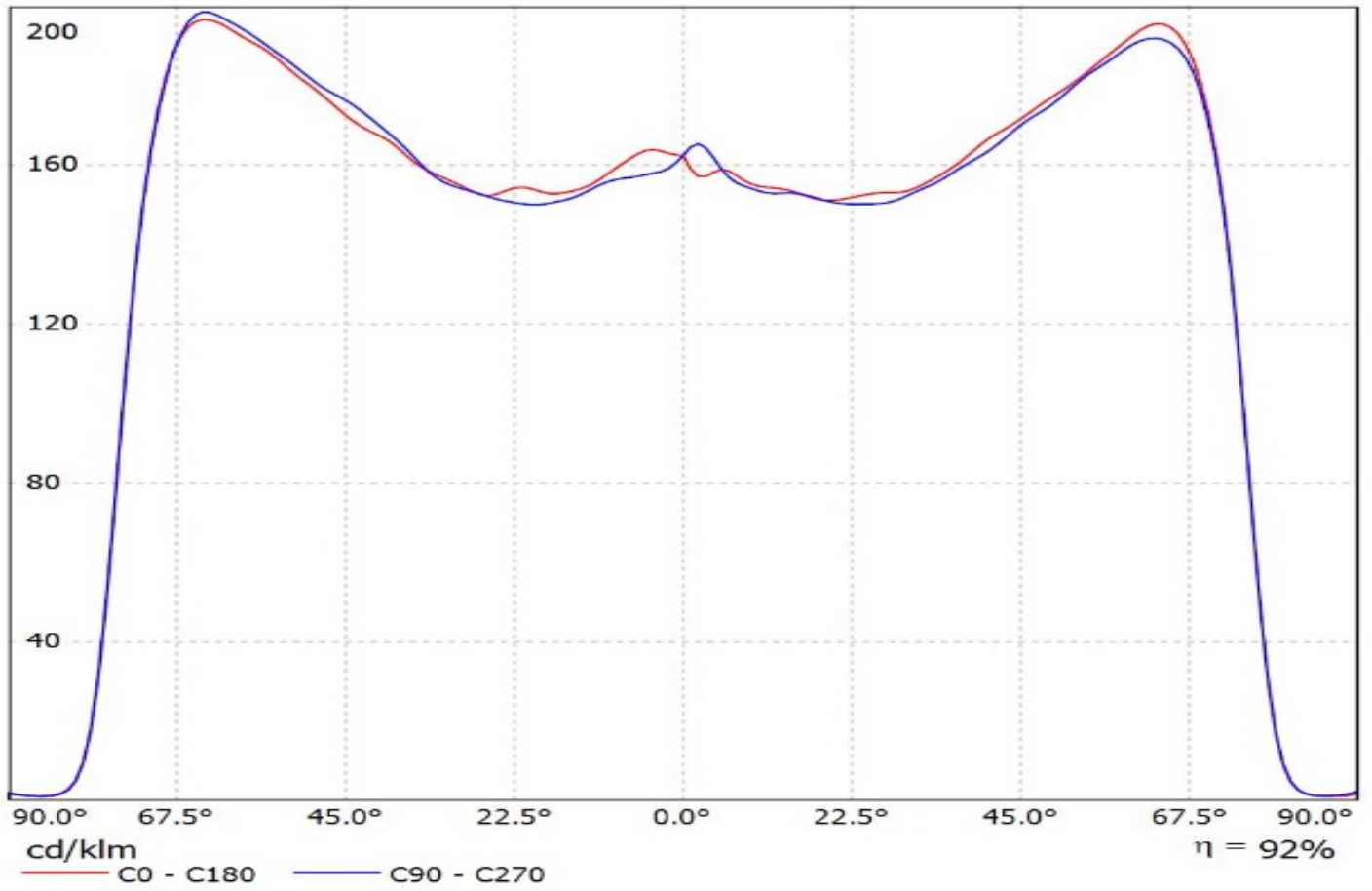

Luminaire: Ledil Oy FN15379_STELLA-VSM_(CXM-22)_(B&W_431_Type_Z1)_SIMULATED
Lamps: 1 x Luminus CXM-22 + Bender & Wirth 431 Type Z1

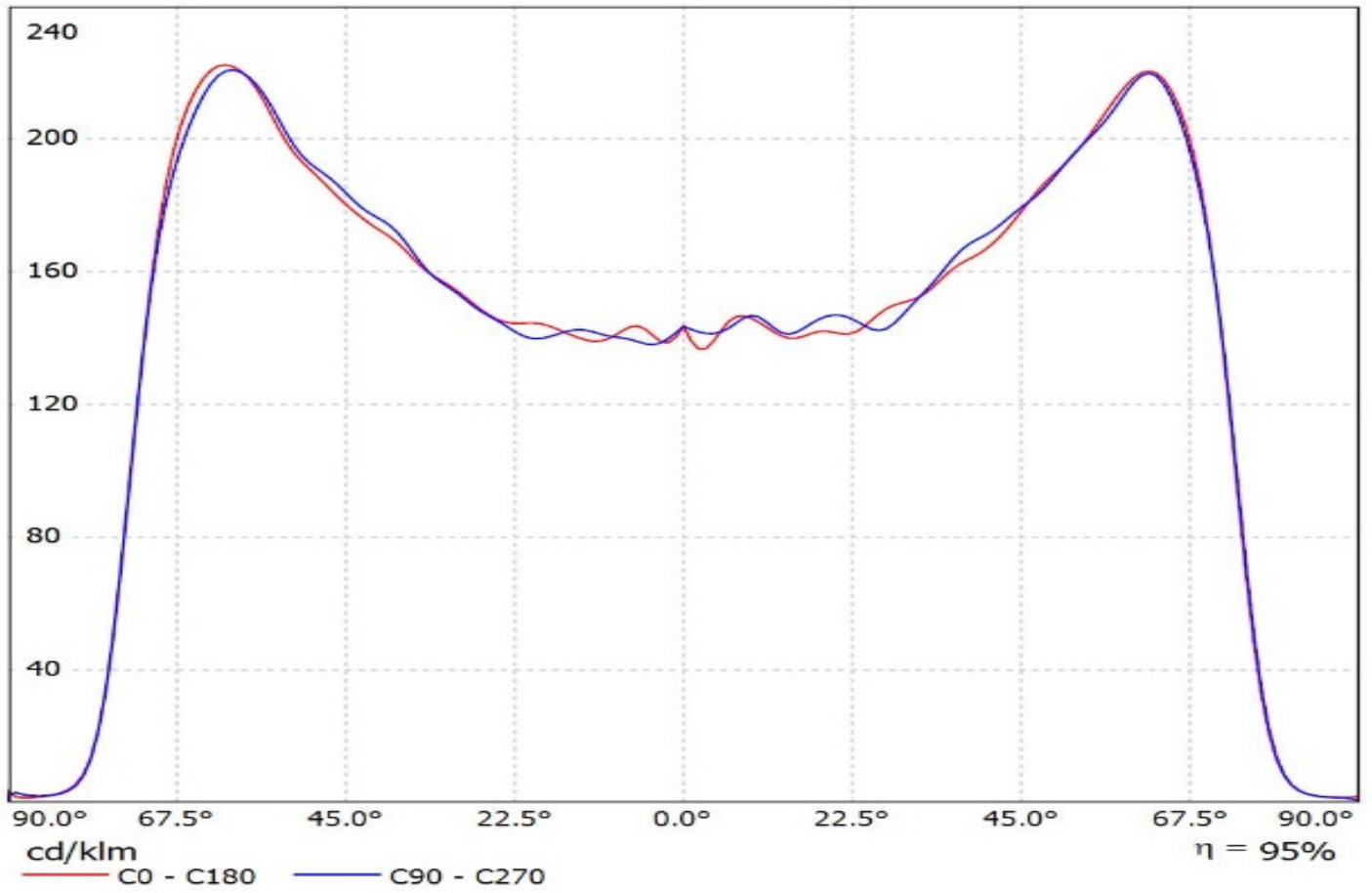

Luminaire: Ledil FN15379_STELLA-VSM_(MJT_180W_Les32,8)

Lamps: 1 x Seoul_MJT_180W_Les33,8mm_(SAWx33GCA)_3860.39lm@250mA_P=21.1143W_I=0.25A

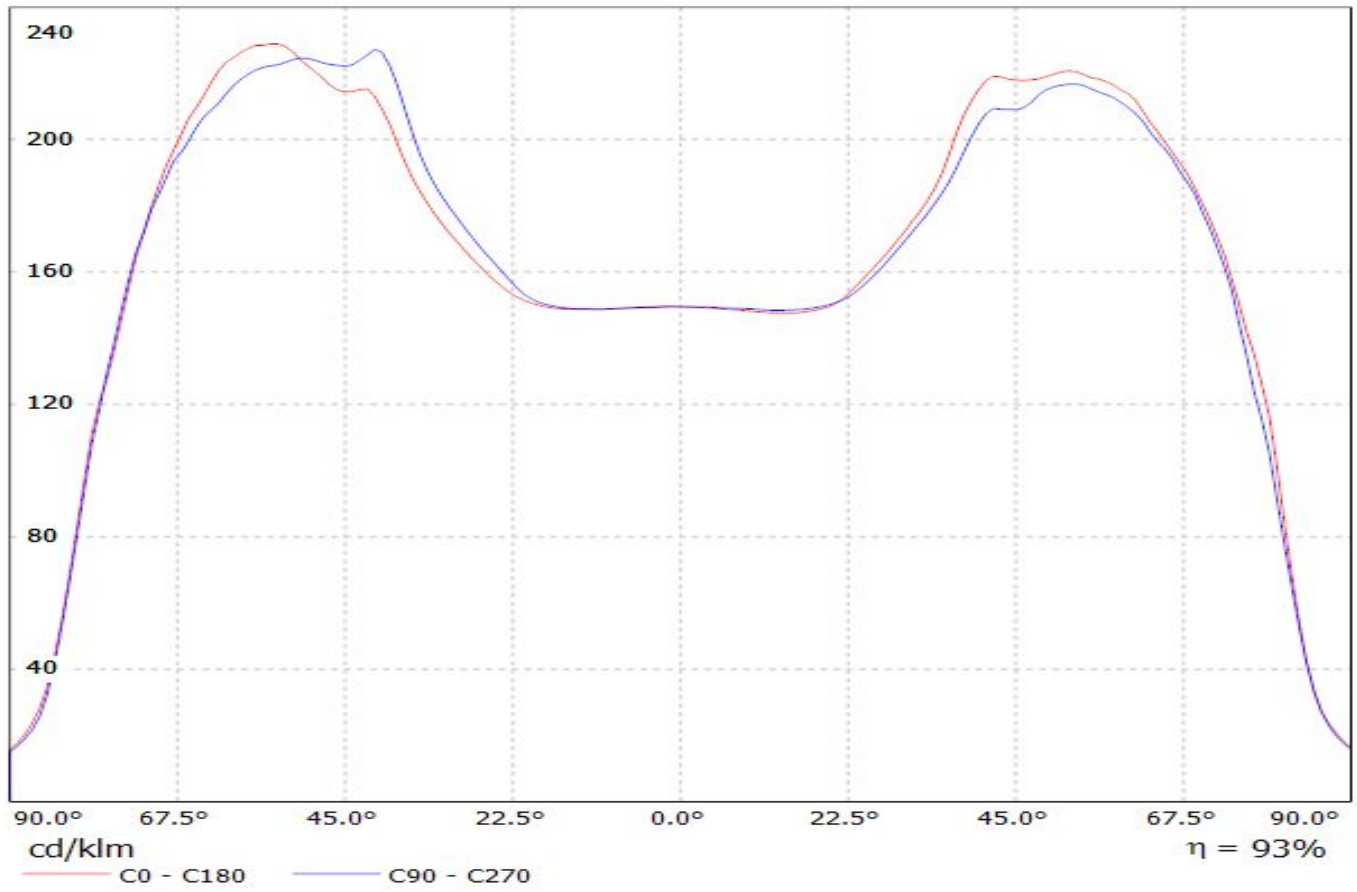

Luminaire: Ledil FN15379_STELLA-VSM_(MJT_80W_Les22)_+431TypZ1

Lamps: 1 x Seoul_MJT_80W_Les22mm_(SAWx22AAA)_+431TypZ1_2508.93lm@250mA_P=13.323W_I=0.25A

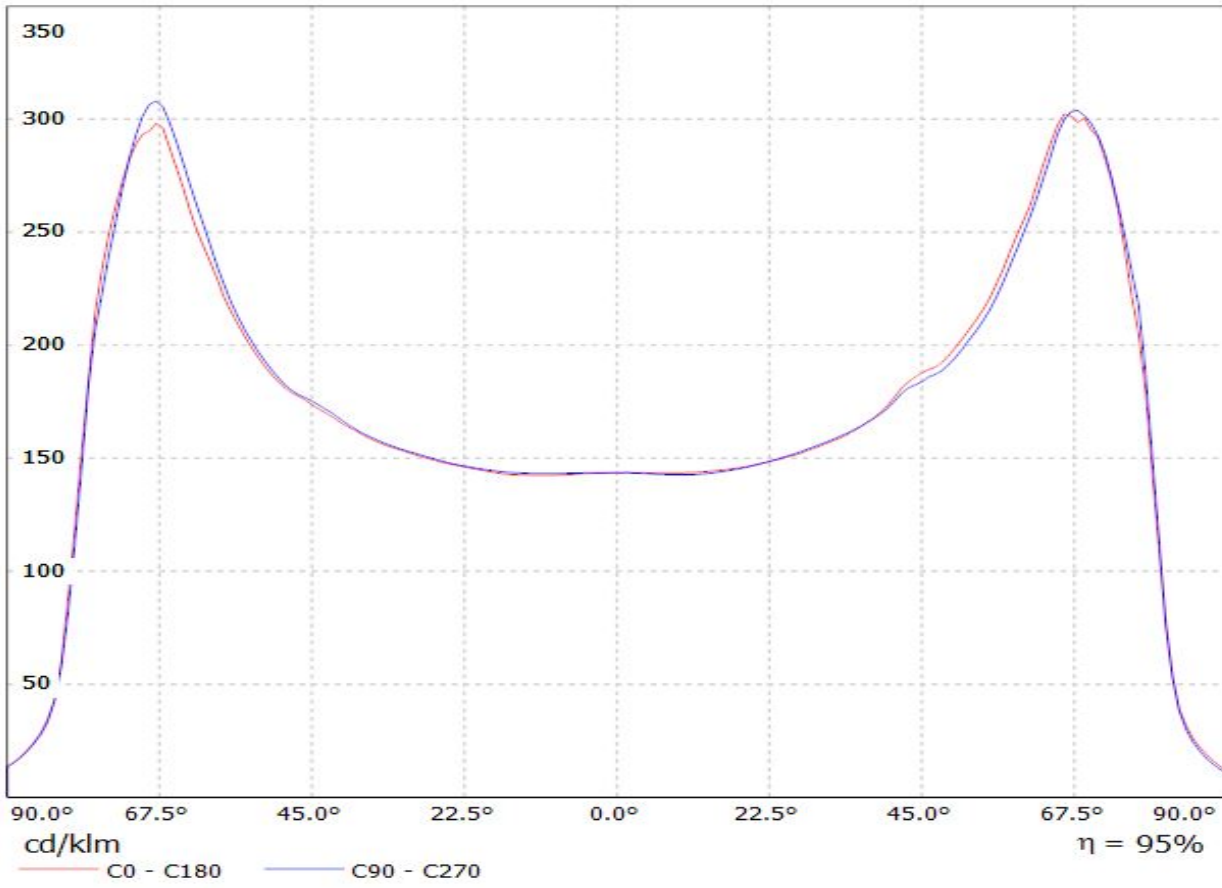

Luminaire: Ledil FN15379_STELLA-VSM_(MJT_30W_Les14,5)_+433_Typ_Z1

Lamps: 1 x Seoul_MJT_30W_Les14,5mm_(SAWx1566A)_433_Typ_Z1_1343.97lm@250mA_P=8.2295W_I=0.25A

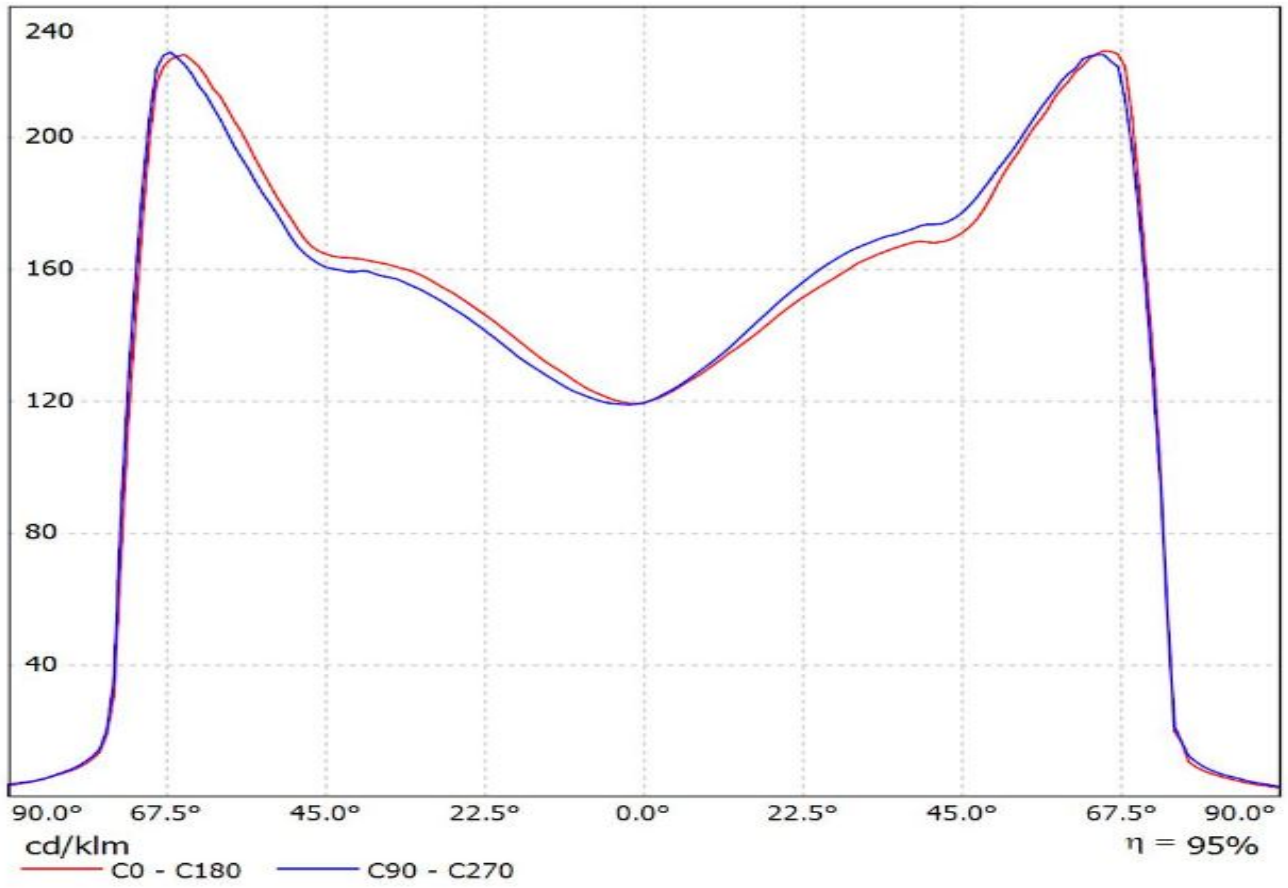

Luminaire: Ledil FN15379_STELLA-VSM_(VERO18)

Lamps: 1 x Bridgelux_Vero18_(BXRE-30E4000-F-23)_1040.57lm@250mA_P=6.7955W_I=0.250A

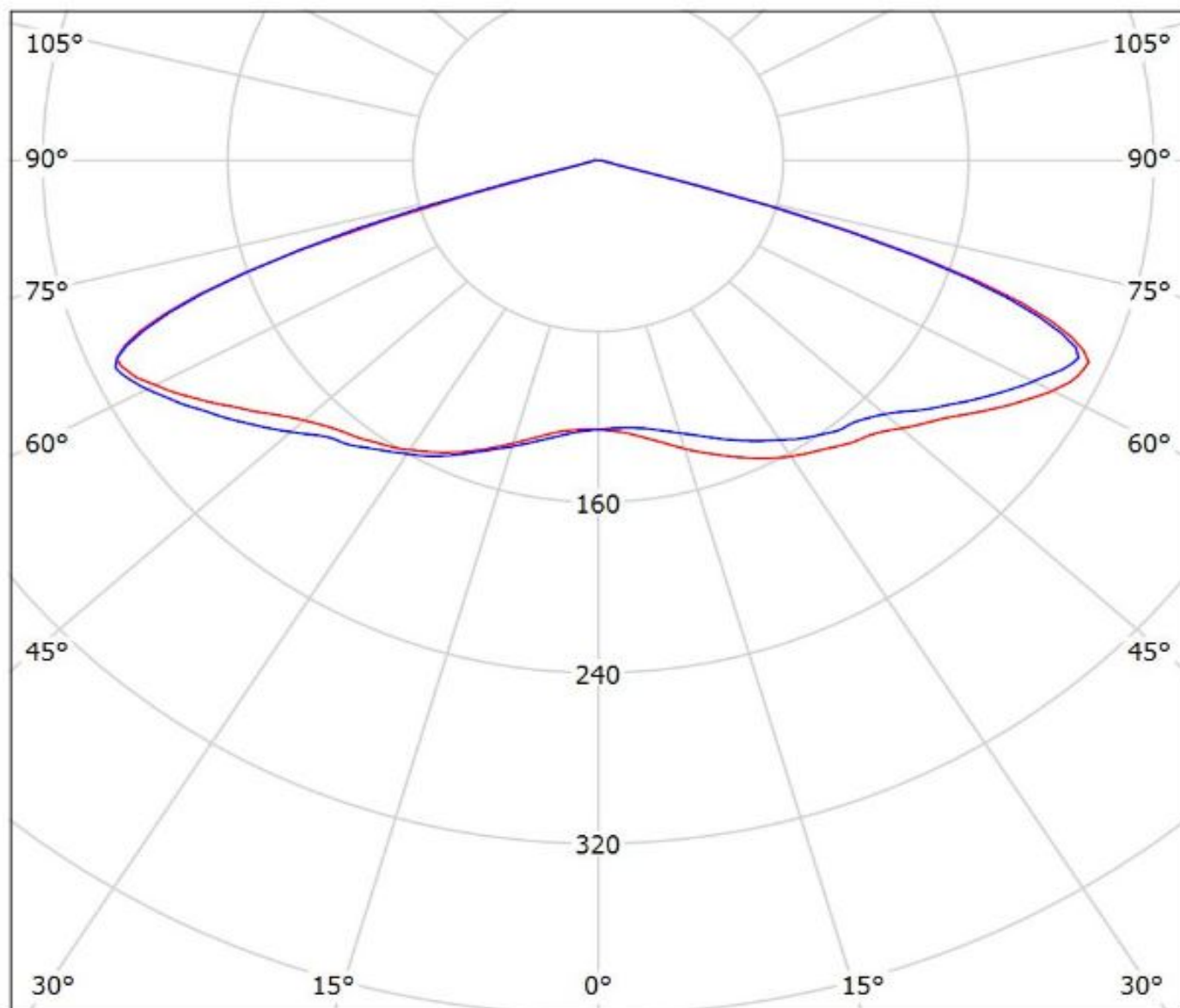

cd/klm

— C0 - C180

— C90 - C270

$\eta = 96\%$

Luminaire: Ledil FN15379_STELLA-VSM_(Vero29_SE_Gen7)
Lamps: 1 x Vero29_SE_Gen7_1759.38lm@250mA_P=8.58975_I=0.25A

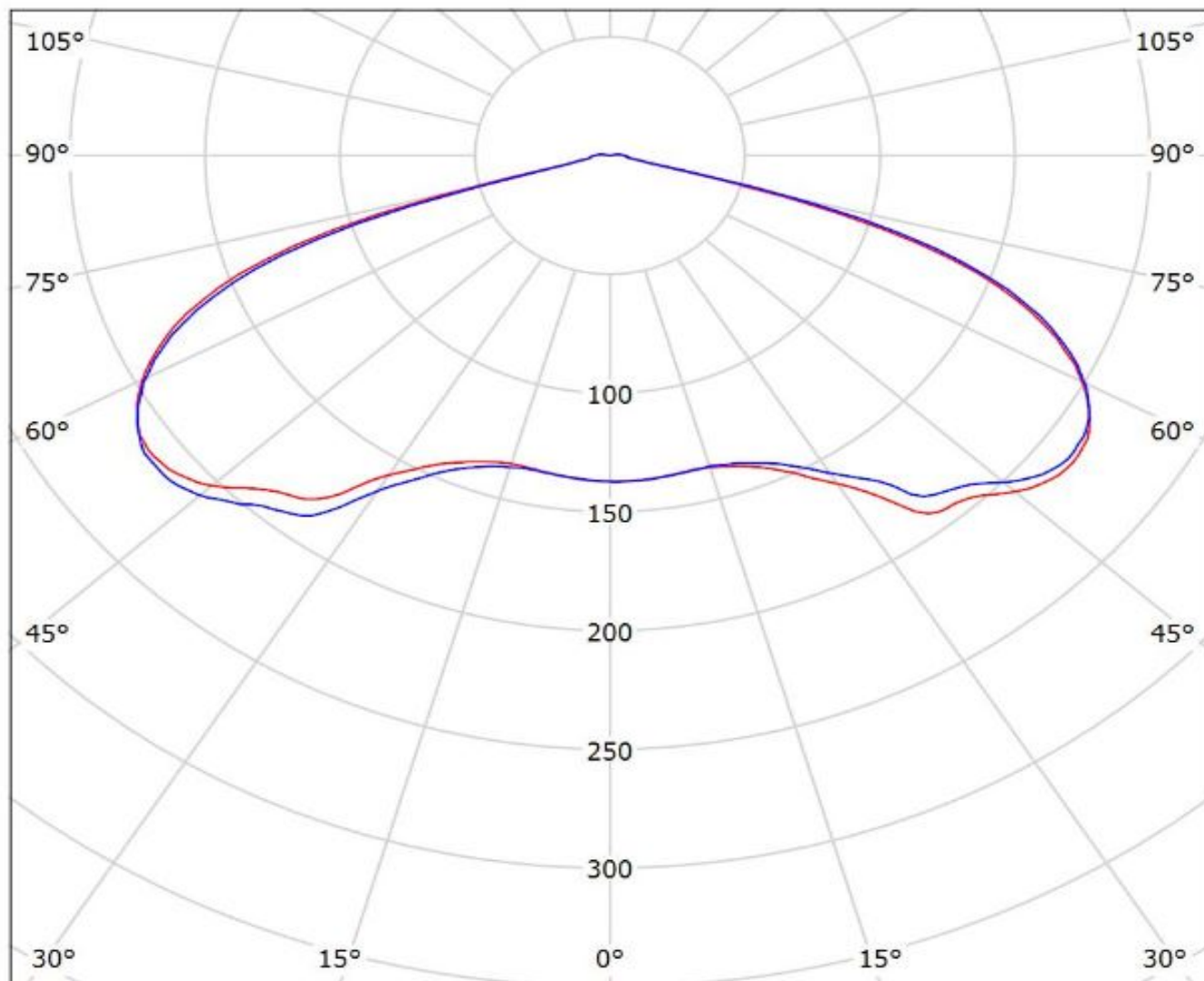

cd/klm
— C0 - C180 — C90 - C270

$\eta = 96\%$

Luminaire: LEDiL Oy FN14976_STELLA-DWC2_(Vero_13_SE)

Lamps: 1 x Bridgelux_Vero_13_SE_(BXRC-30E2000-C-73-SE)_1028.9lm@250mA_CCT=3000K_P=8.23391W_I=0.25A

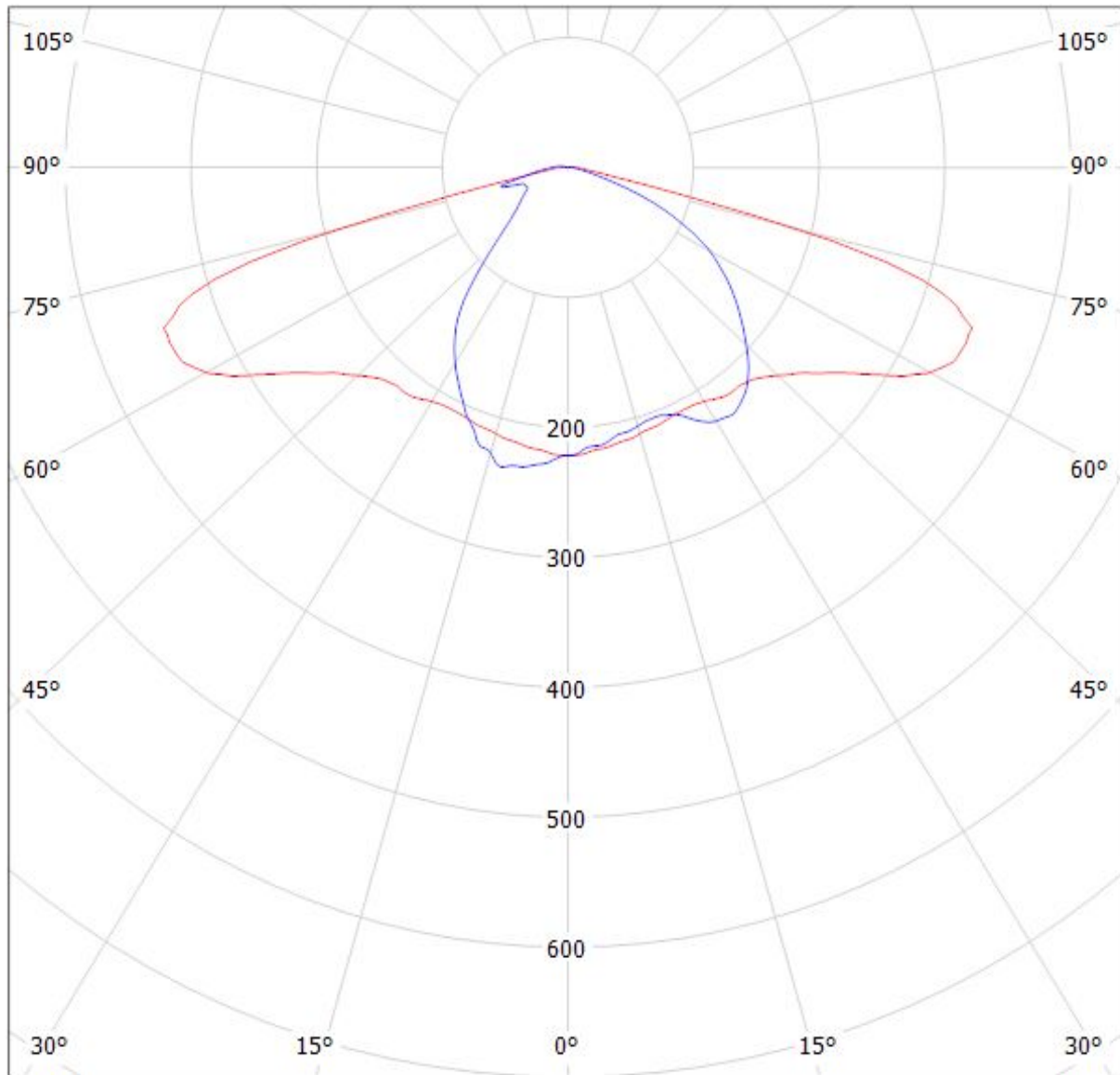

cd/klm

— C0 - C180 — C90 - C270

$\eta = 90\%$

Luminaire: LEDiL Oy FN15379_STELLA-VSM_(VERO18_SE)
Lamps: 1 x Bridgelux_VERO18_SE_(BXRC-30E4000-C-73-SE)
_1335.46lm@250mA_P=7.9961W_I=0.25A

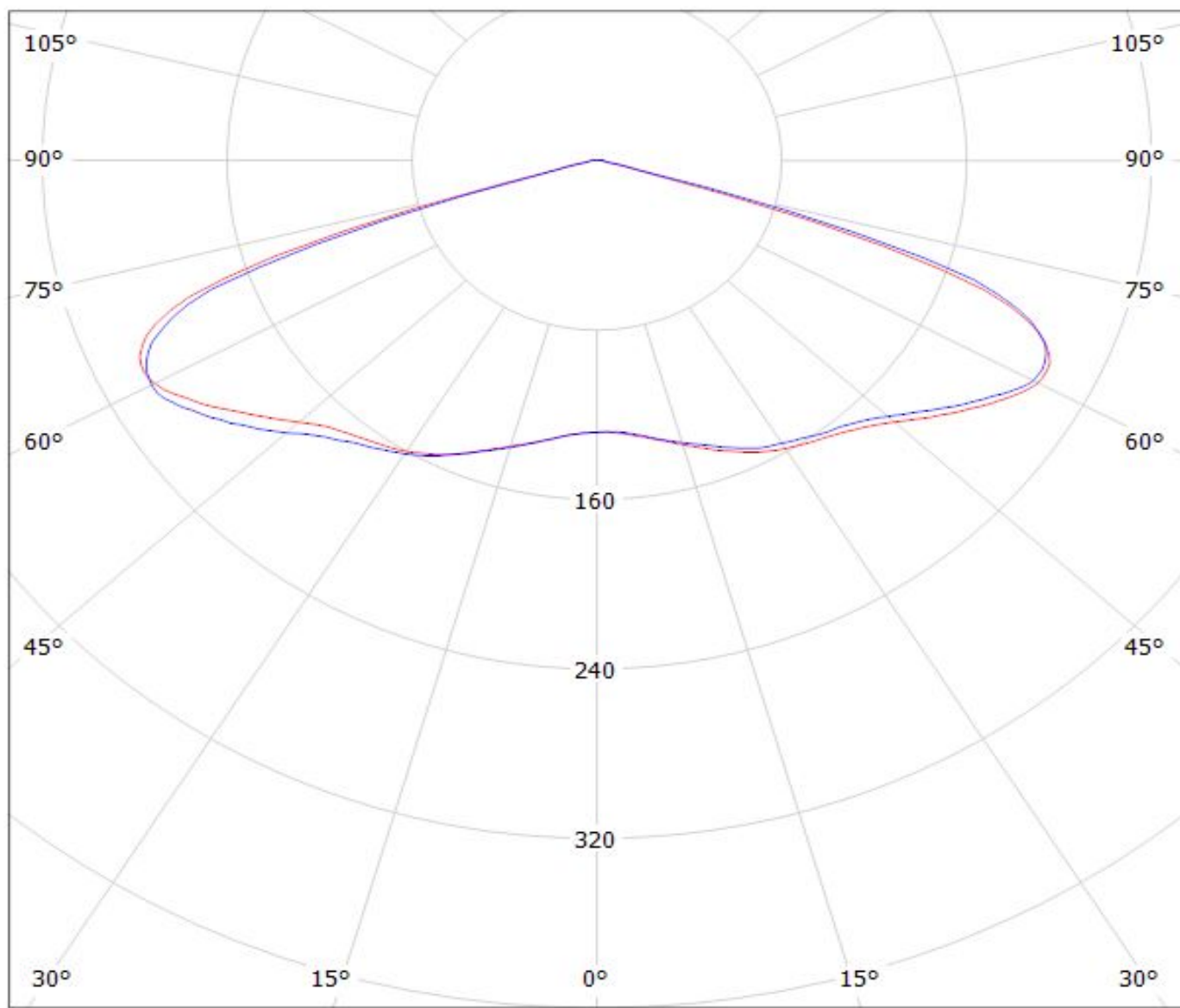

cd/klm

$\eta = 95\%$

— C0 - C180 — C90 - C270

Luminaire: Ledil Oy FN15379_STELLA-VSM+_Bender&Wirth - LED holder 434 Typ Z1_BRIDGELUX_V10_Gen7_SIMULATED
Lamps: 1 x BRIDGELUX V10 Gen7

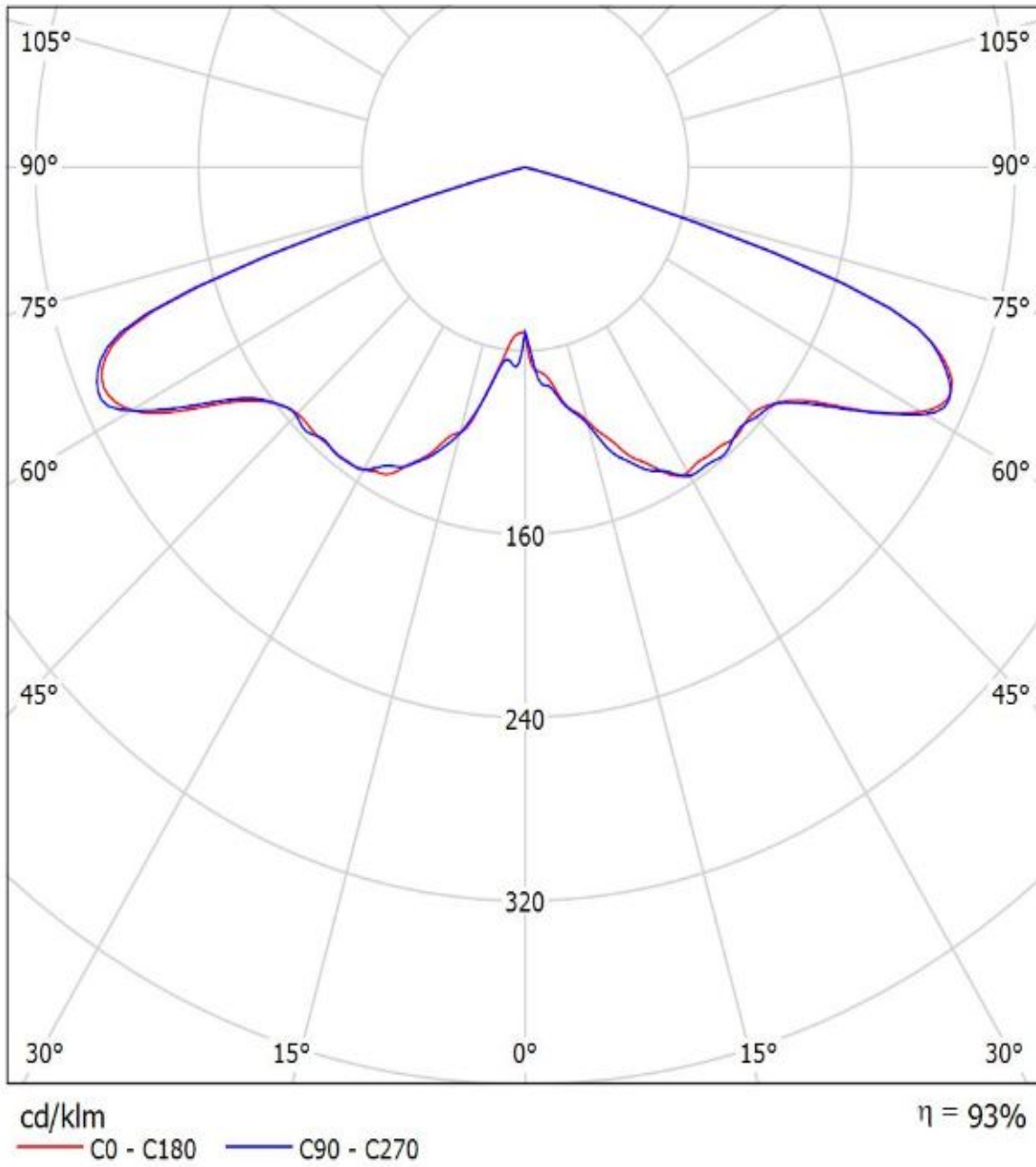

Luminaire: LEDiL Oy FN15379_STELLA-VSM_(V22_Gen7+BW)
Lamps: 1 x Bridgelux_V22_Gen7_(BXRE-30E6500-B)
+BW431_TypZ1_2036.72lm@250mA_P=11.891W_I=0.250A

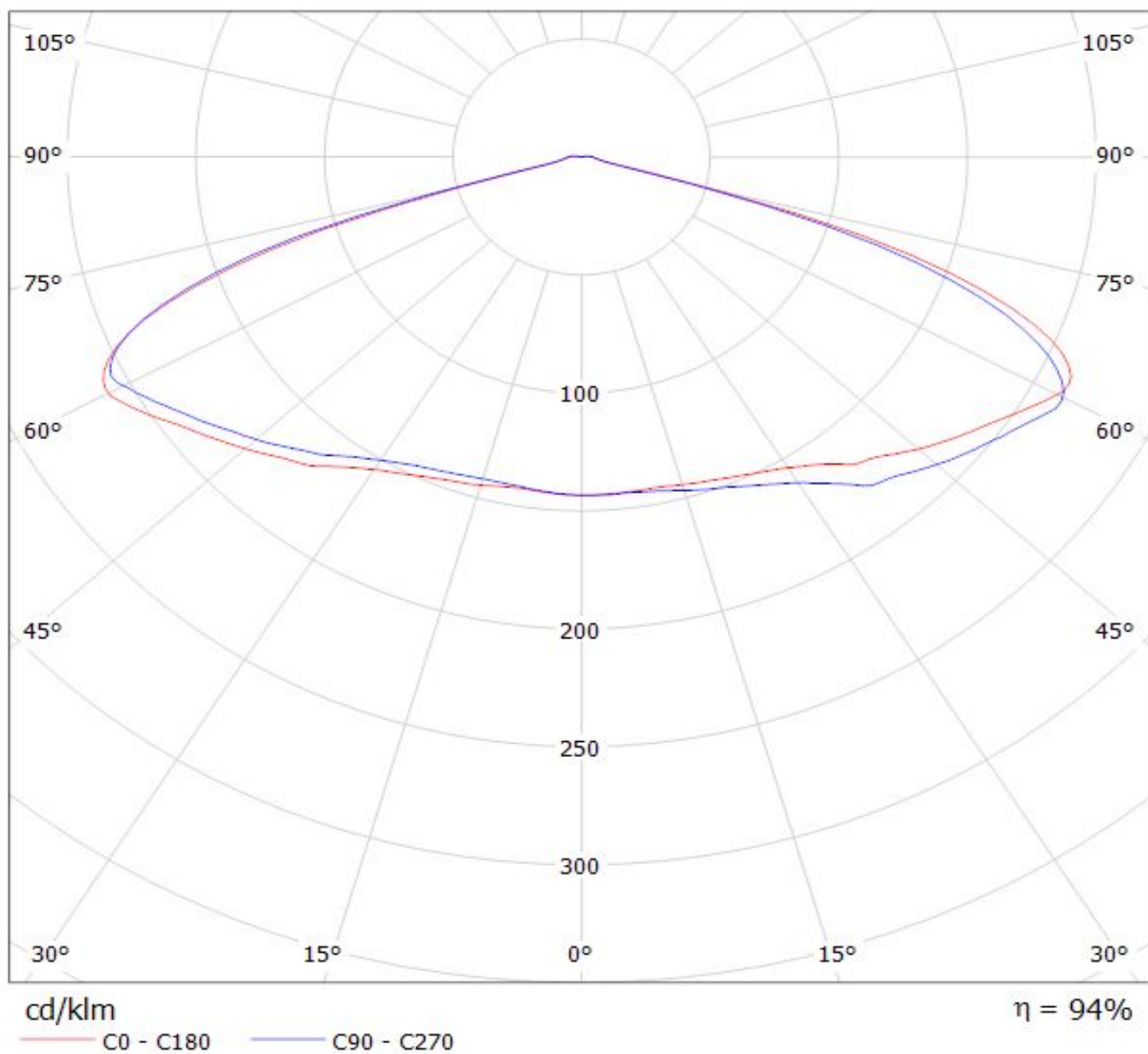

Luminaire: LEDiL Oy FN15379_STELLA-VSM_(V18_Gen7)+BW439_Typ_L3

Lamps: 1 x Bridgelux_V18_Gen7_(BXRE-30E4000-B)+BW439_Typ_L3_1360.58lm@250mA_P=8.07828W_I=0.25A

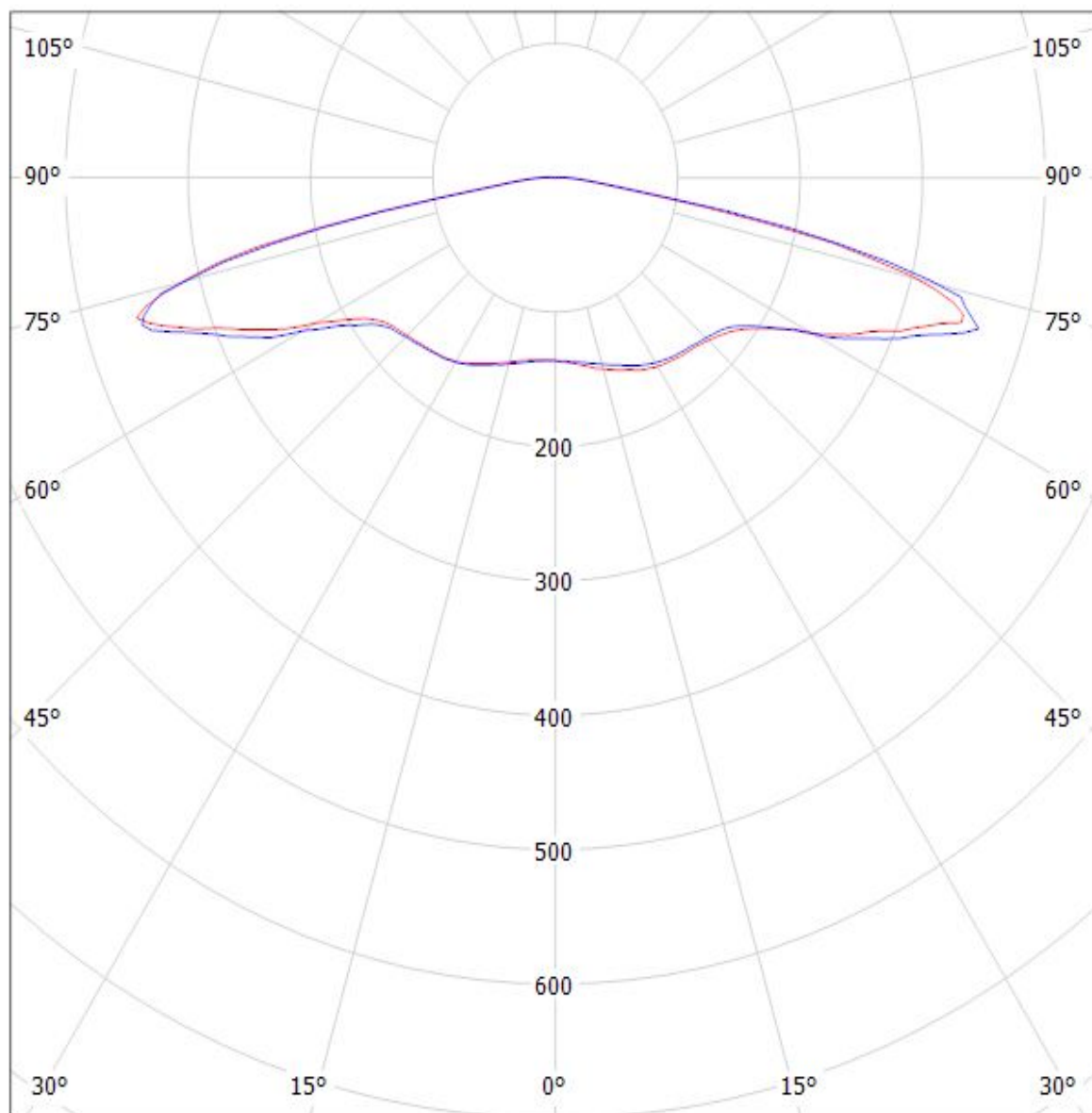

cd/klm

$\eta = 94\%$

— C0 - C180 — C90 - C270

Luminaire: Ledil Oy FN15379_STELLA-VSM_simulated_CLU044
Lamps: 1 x Citizen CLU044

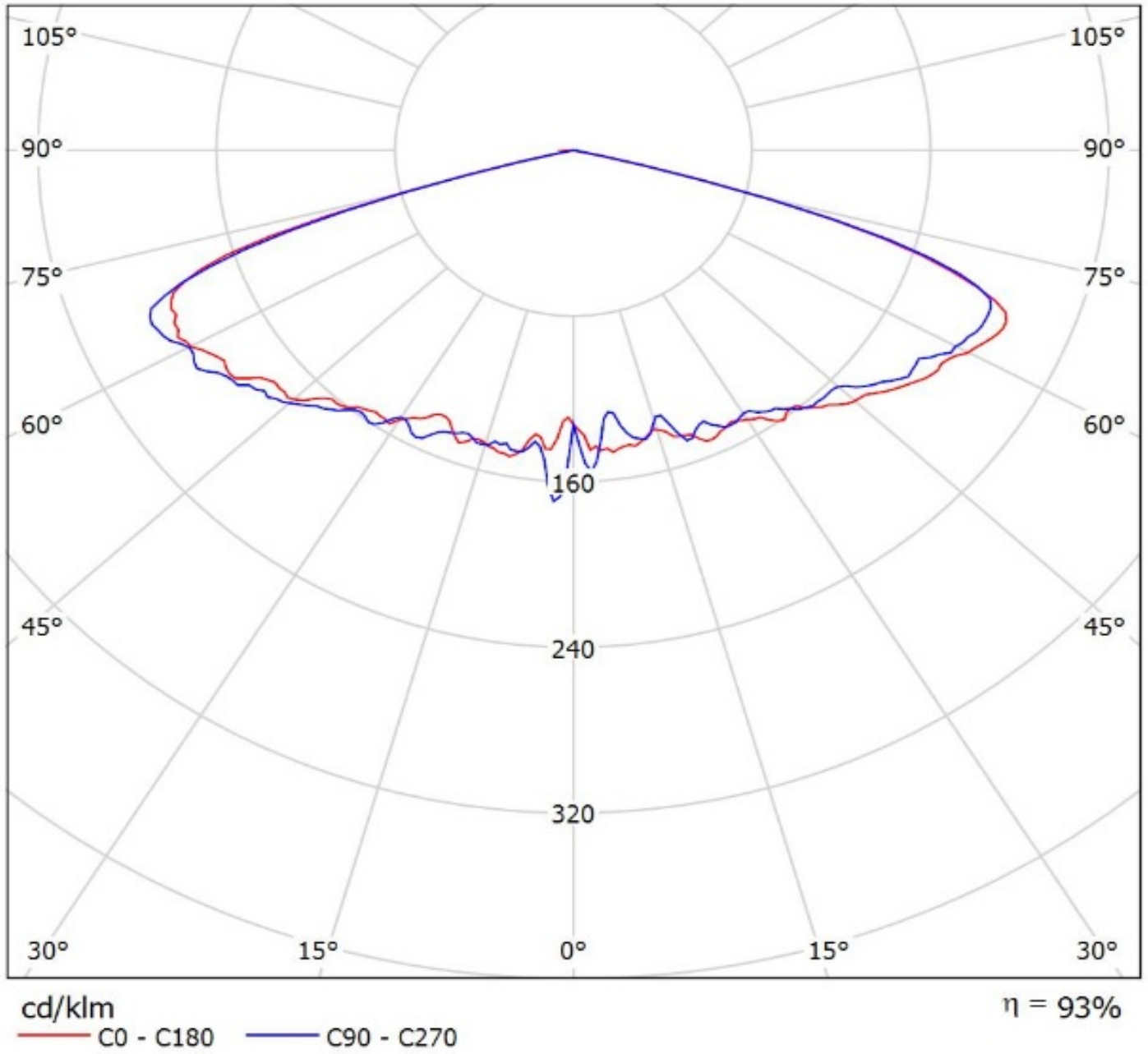

Luminaire: Ledil FN15379_STELLA-VSM_(CLU054)

Lamps: 1 x Citizen_CLU054_(CLU054-1825B8-503MIA2)_1939.14lm@250mA_P=11.752W_I=0.25A

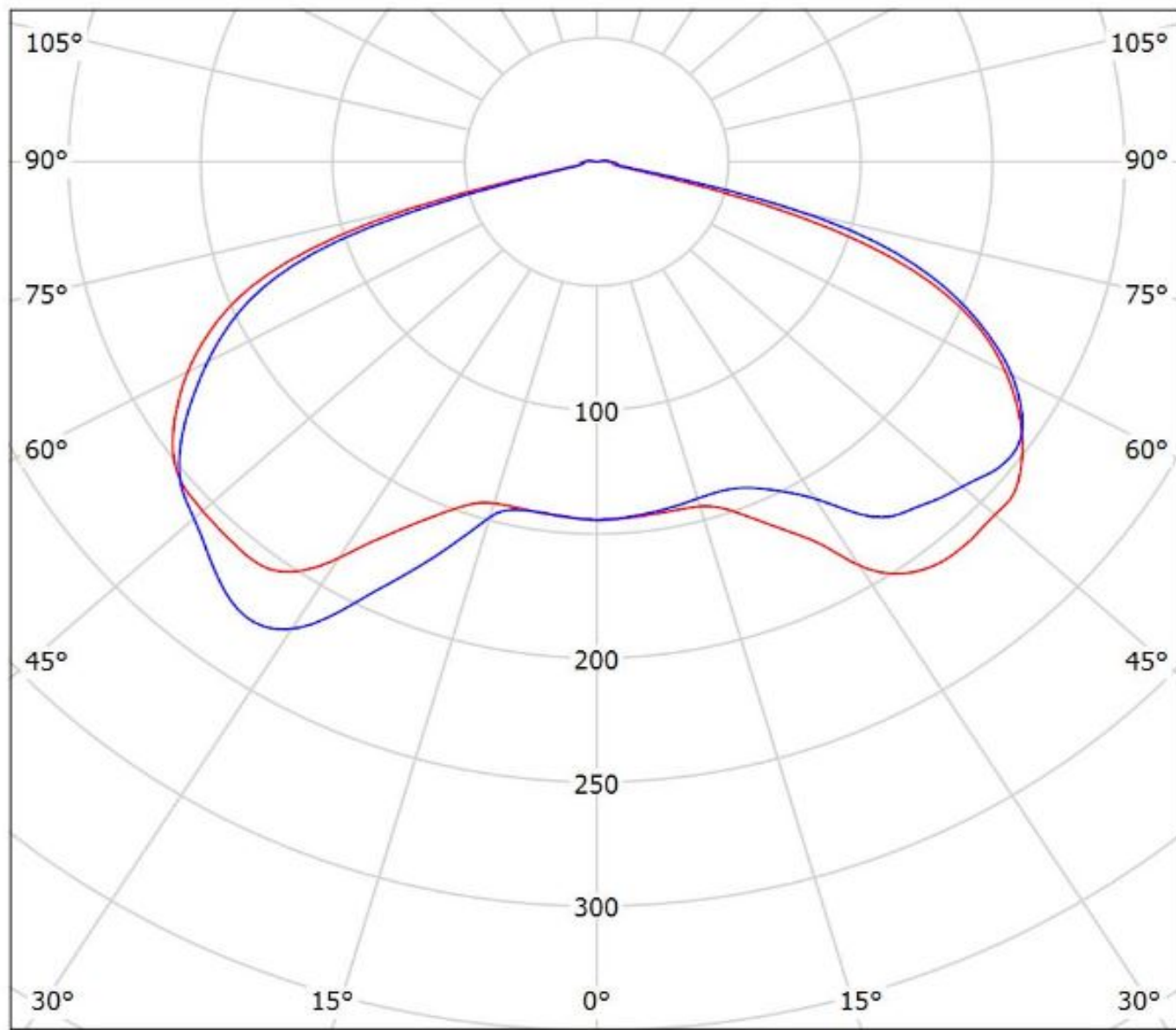

cd/klm

— C0 - C180 — C90 - C270

η = 95%

Luminaire: Ledil Oy FN15379_STELLA-VSM_(CLU048)_(B&W_431_Type_Z1)_SIMULATED
Lamps: 1 x Citizen CLU048 + Bender & Wirth 431 Type Z1

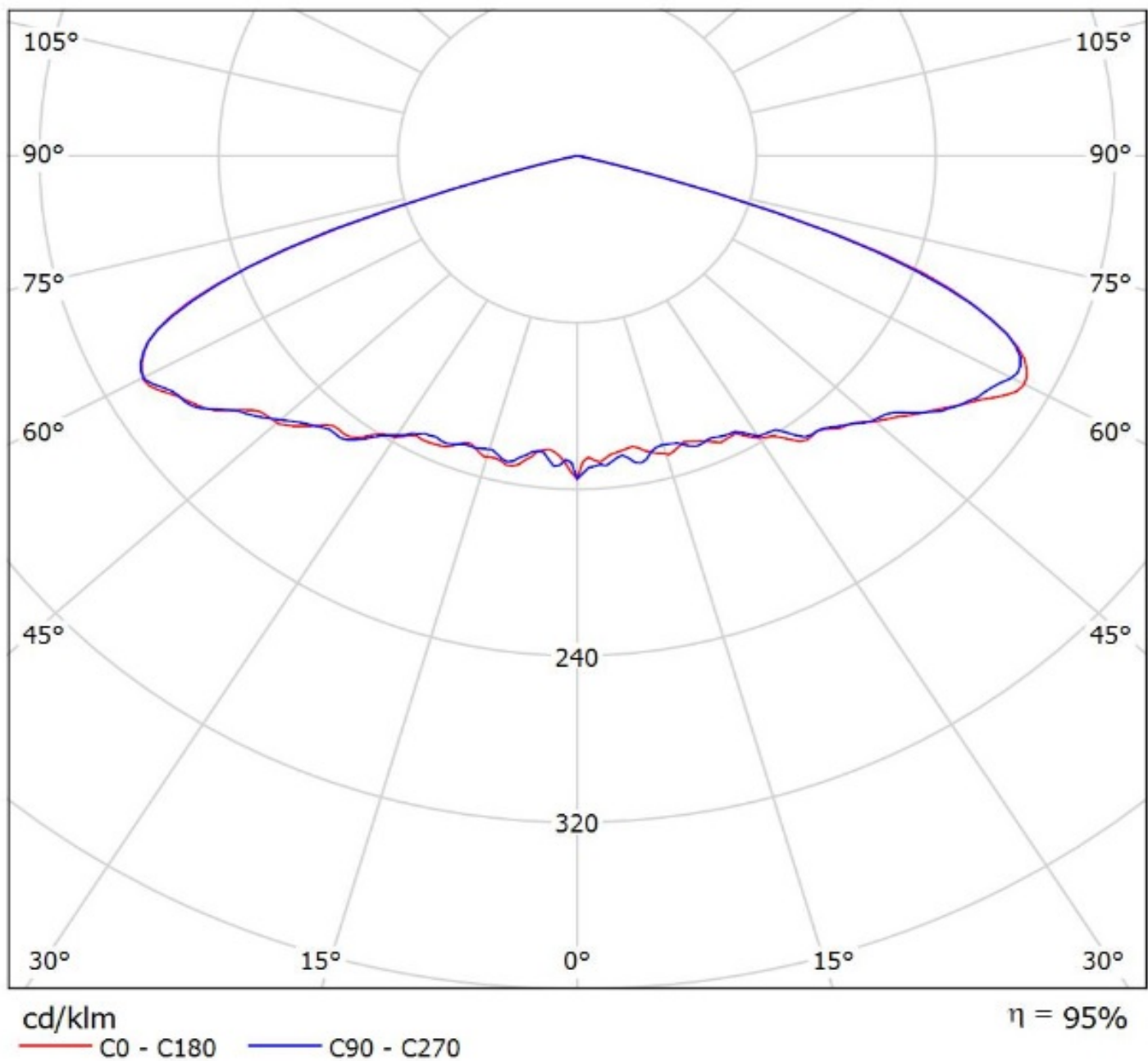

Luminaire: Ledil Oy FN15379_STELLA-VSM+_Bender+Wirth 447 Typ Z1_CREE_CXB3070_SIMULATED
Lamps: 1 x CREE CXB3070

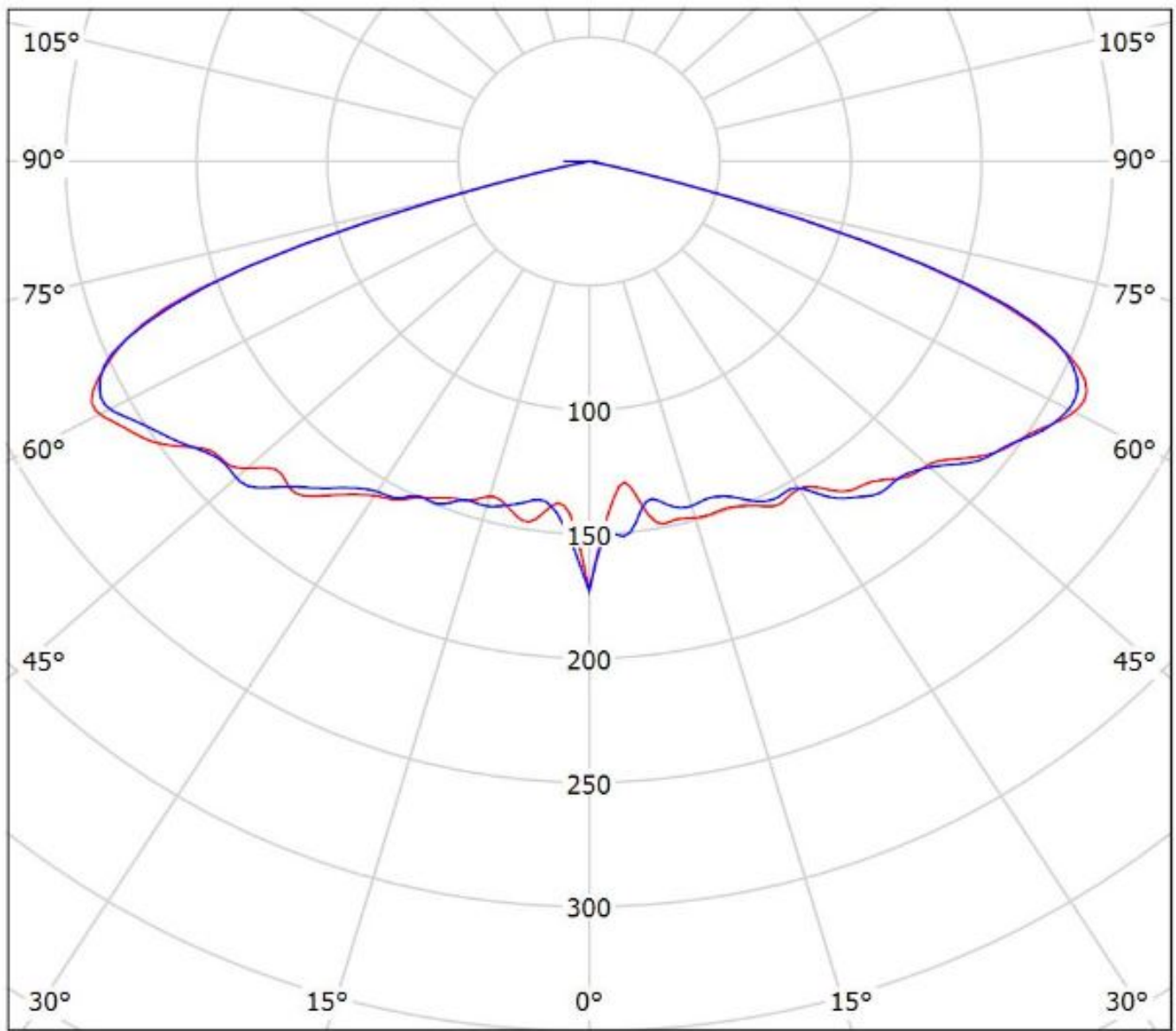

cd/klm
— C0 - C180 — C90 - C270

$\eta = 94\%$

Luminaire: Ledil Oy FN15379_STELLA-VSM_(CXB2540)_SIMULATED
Lamps: 1 x Cree CXB 2540

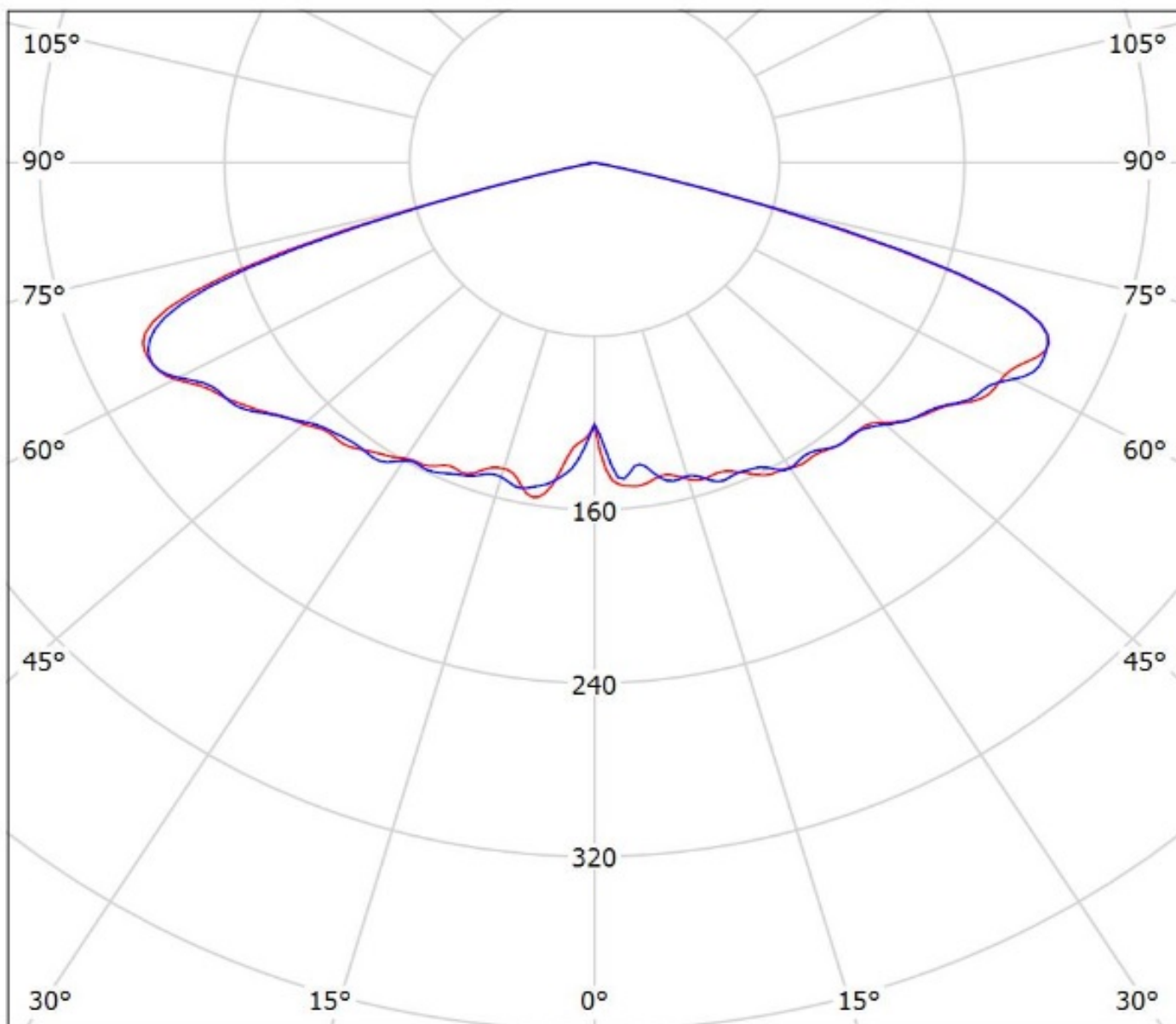

cd/klm

— C0 - C180 — C90 - C270

$\eta = 96\%$

Luminaire: Ledil FN15379_STELLA-VSM_(Luxeon_1208)

Lamps: 1 x Lumileds_Luxeon_1208_(LHC1-3080-1208)_1076.07lm250mA_P=8.2273W_I=0.250A

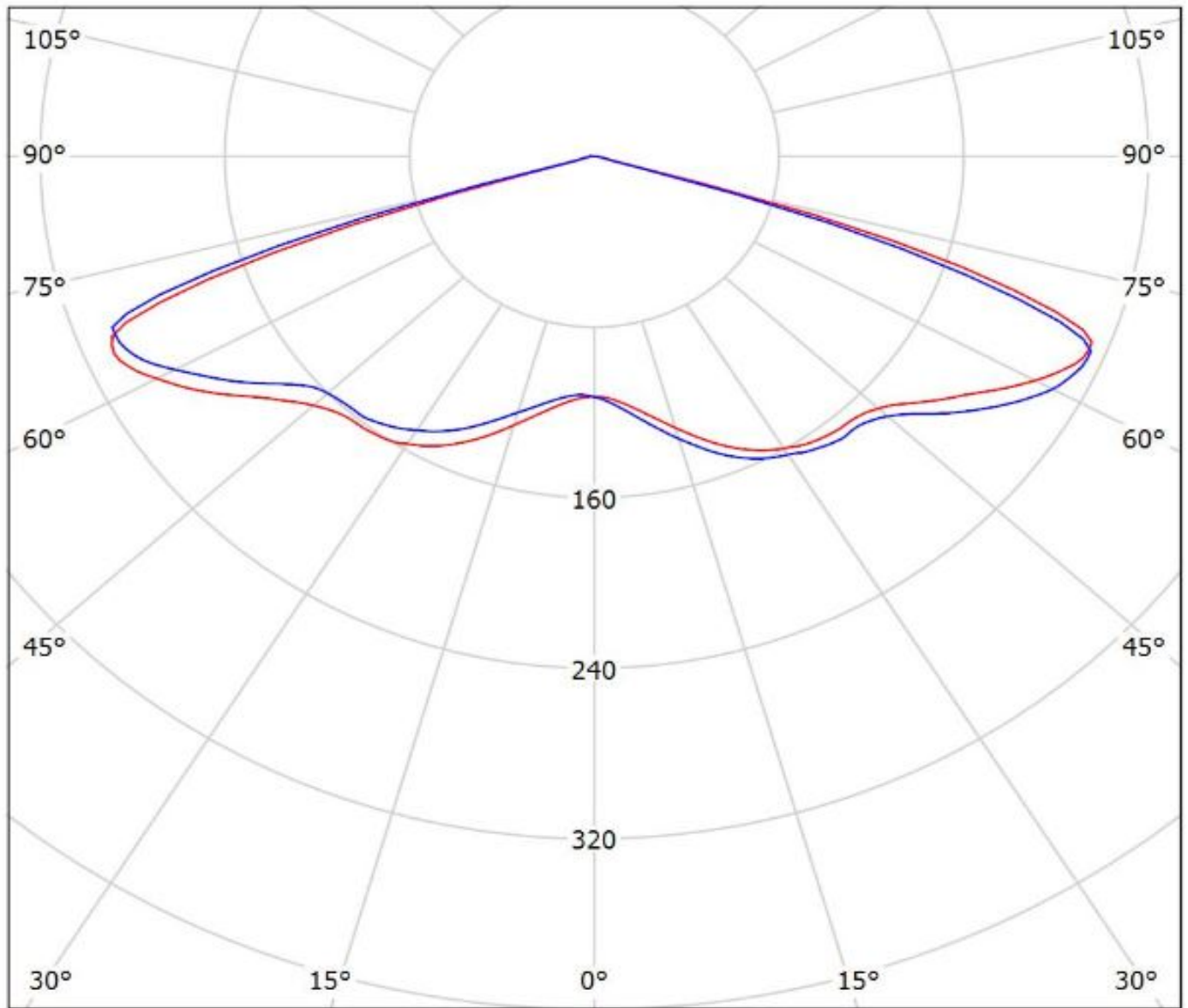

cd/klm
— C0 - C180 — C90 - C270

$\eta = 96\%$

Luminaire: Ledil Oy FN15379_STELLA-VSM_(Luxeon_CoB_1216)_(431_Typ_Z1)_SIMULATED
Lamps: 1 x Lumileds Luxeon CoB 1216 + Bender & Wirth 431 Type Z1

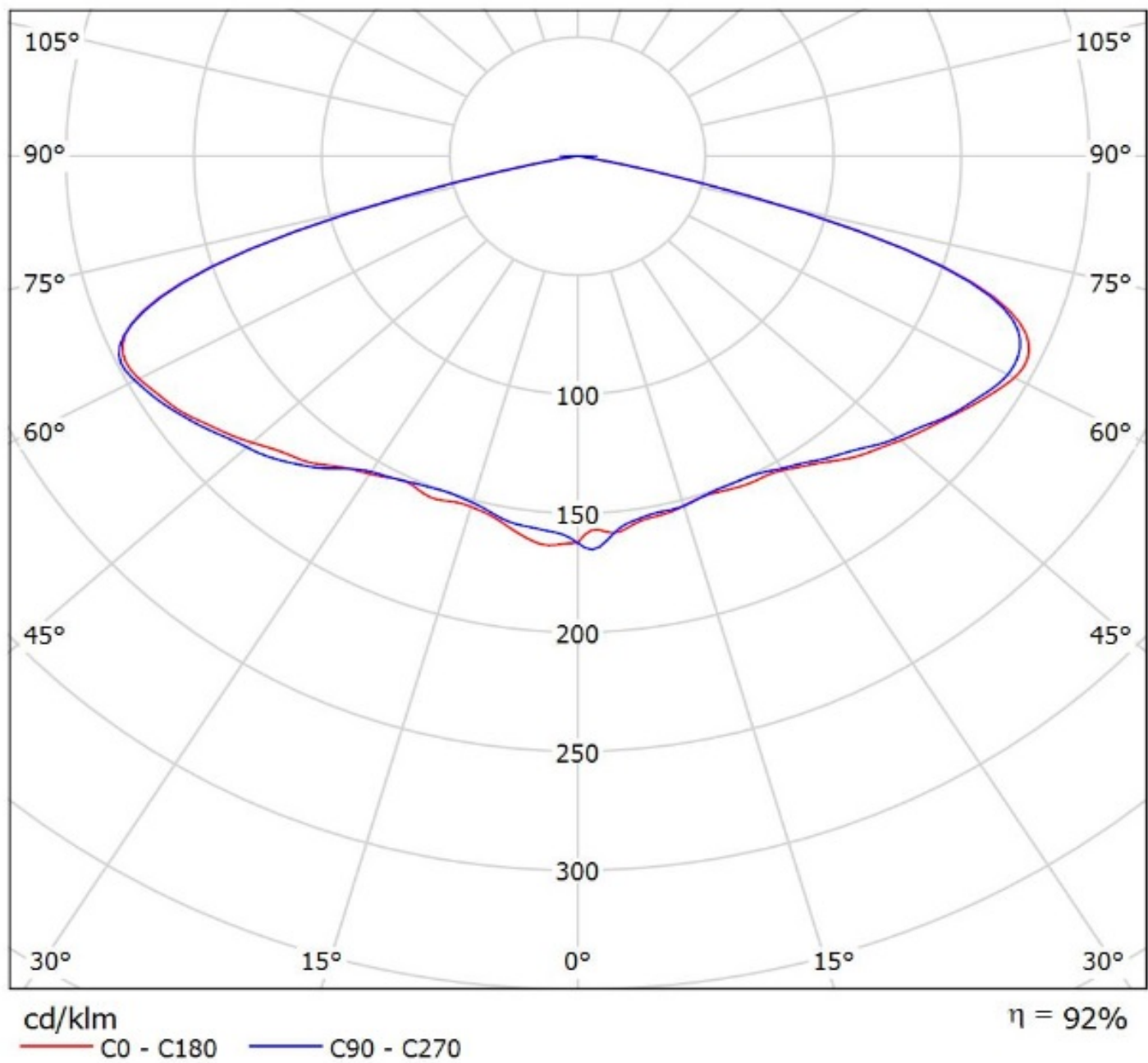

Luminaire: Ledil Oy FN15379_STELLA-VSM_(CXM-22)_(B&W_431_Type_Z1)_SIMULATED
Lamps: 1 x Luminus CXM-22 + Bender & Wirth 431 Type Z1

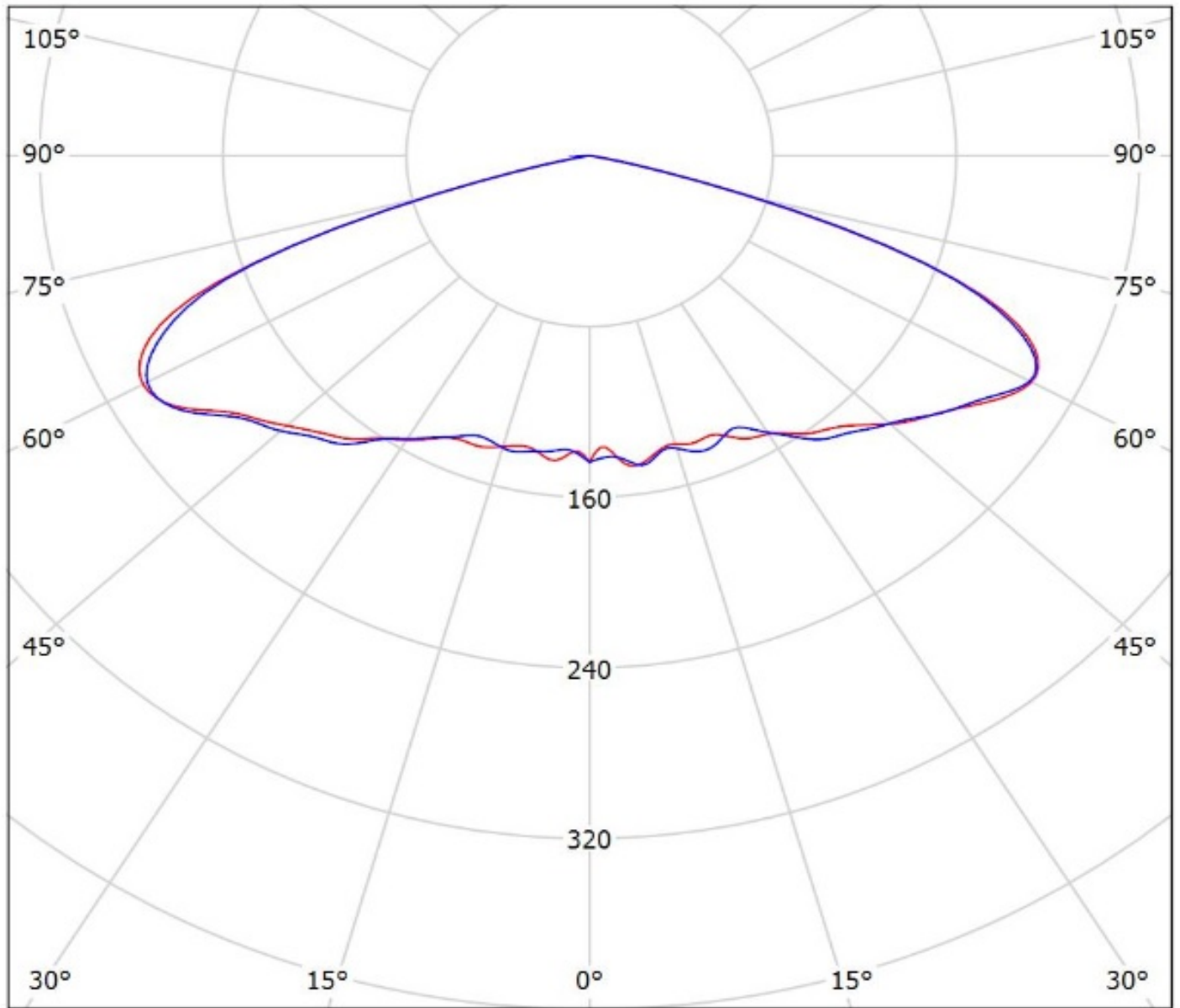

cd/klm

— C0 - C180 — C90 - C270

$\eta = 95\%$

Luminaire: Ledil FN15379_STELLA-VSM_(MJT_180W_Les32,8)

Lamps: 1 x Seoul_MJT_180W_Les33,8mm_(SAWx33GCA)_3860.39lm@250mA_P=21.1143W_I=0.25A

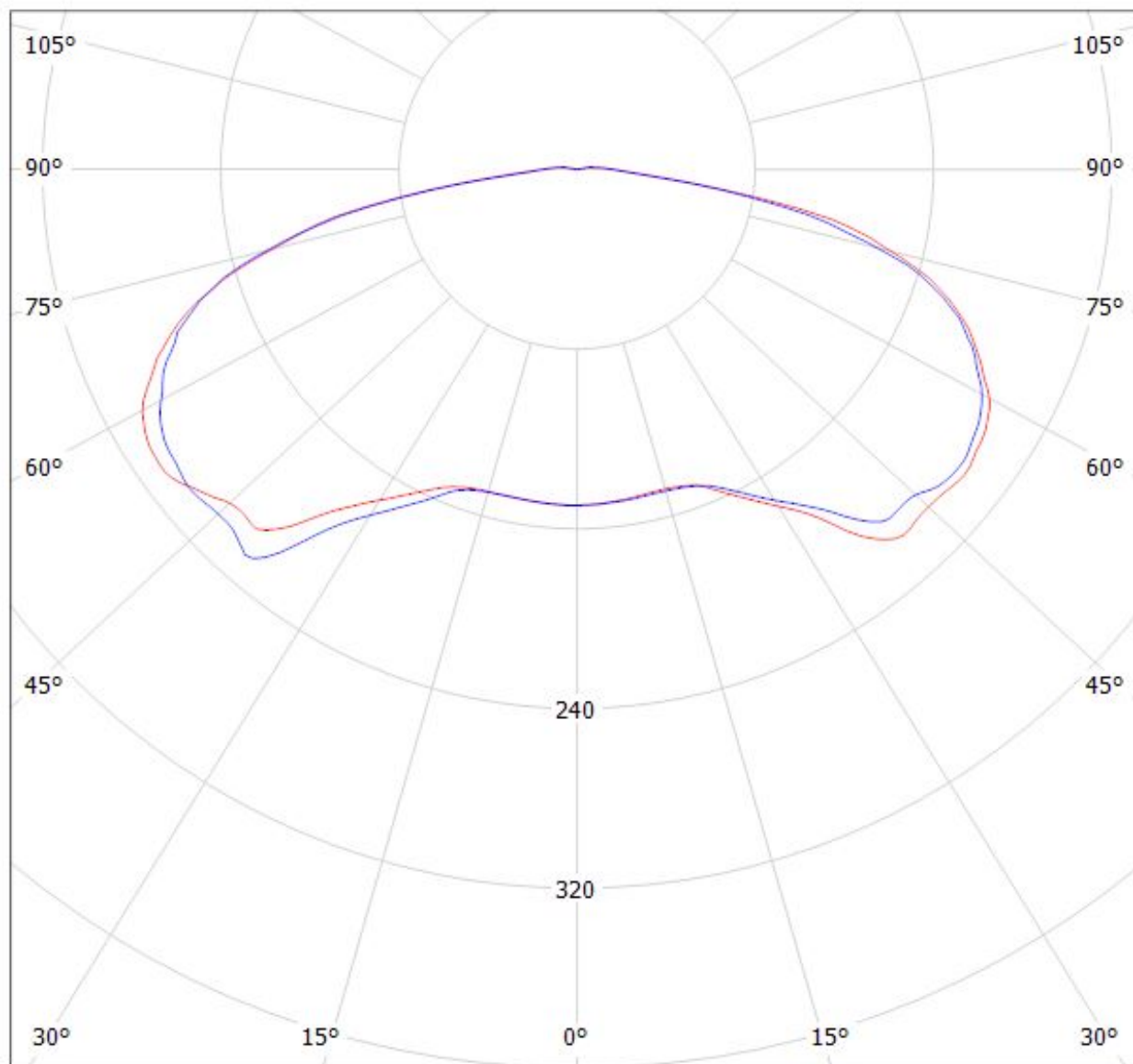

cd/klm

$\eta = 93\%$

— C0 - C180 — C90 - C270

Luminaire: Ledil FN15379_STELLA-VSM_(MJT_80W_Les22)_+431TypZ1

Lamps: 1 x Seoul_MJT_80W_Les22mm_(SAWx22AAA)_+431TypZ1_2508.93lm@250mA_P=13.323W_I=0.25A

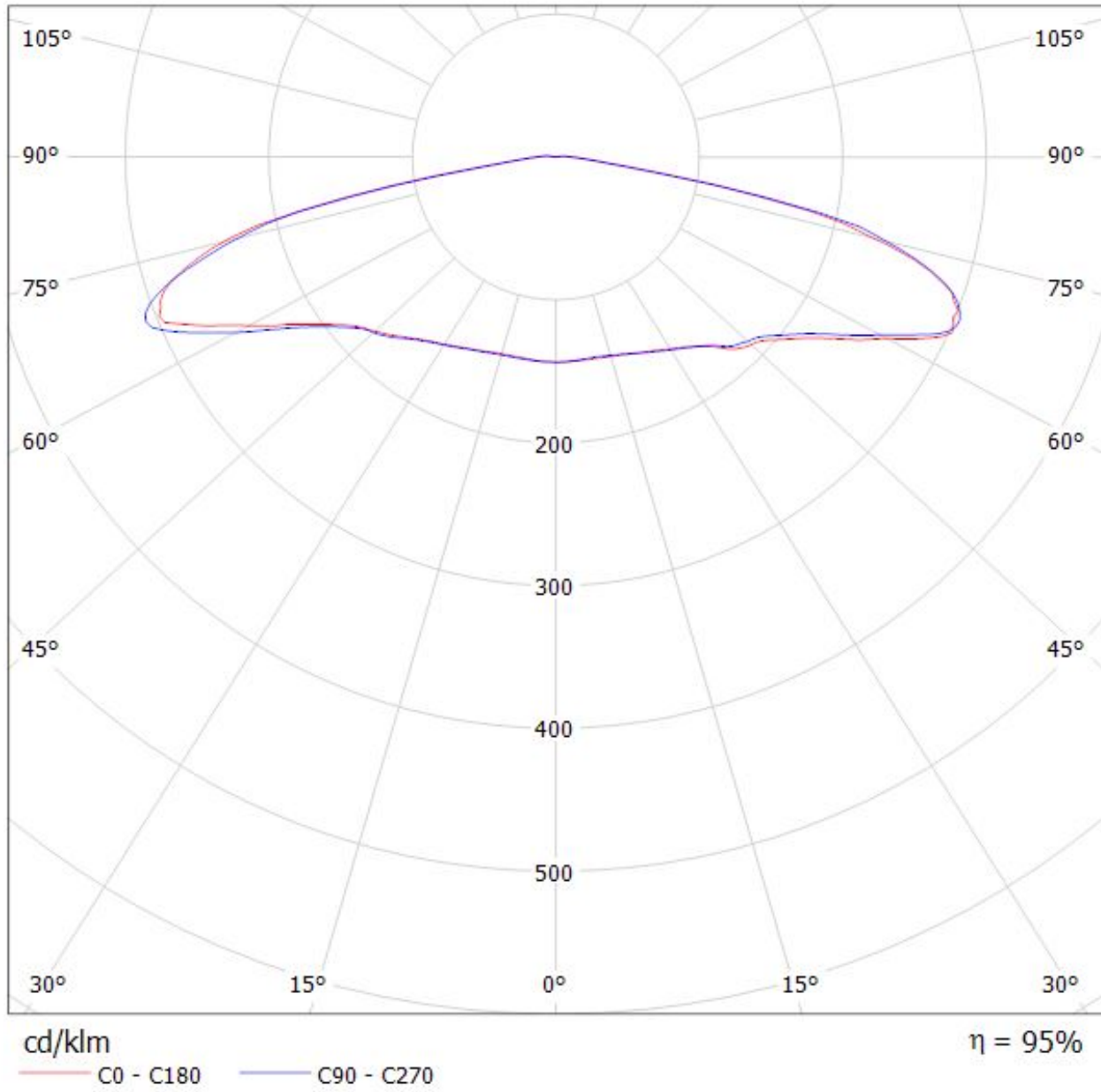

Luminaire: Ledil FN15379_STELLA-VSM_(MJT_30W_Les14,5)_+433_Typ_Z1

Lamps: 1 x Seoul_MJT_30W_Les14,5mm_(SAWx1566A)_433_Typ_Z1_1343.97lm@250mA_P=8.2295W_I=0.25A

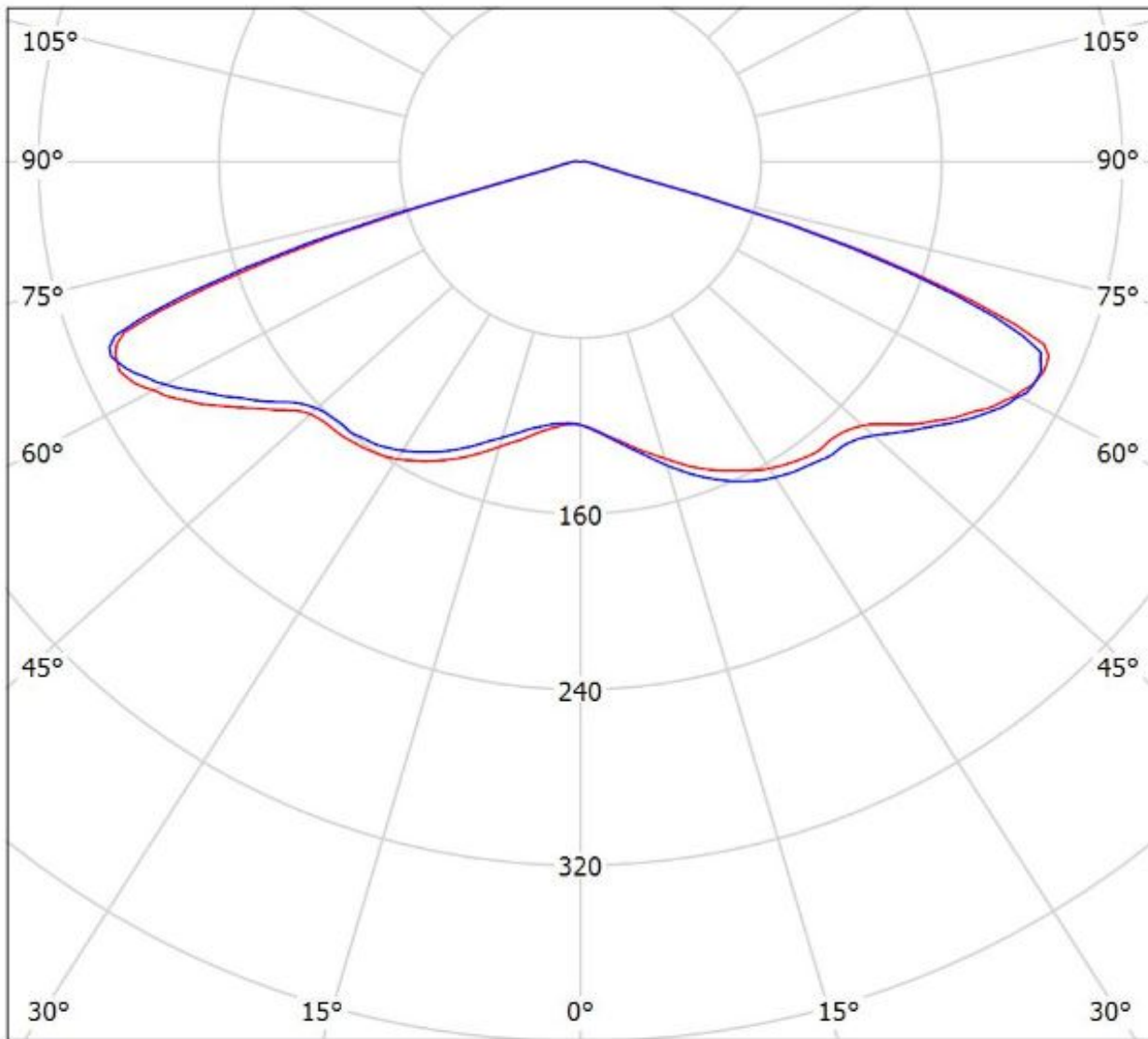

cd/klm

— C0 - C180 — C90 - C270

$\eta = 95\%$

NOTE: The typical divergence will be changed by different color, chip size and chip position tolerance. The typical total divergence is the full angle measured where the luminous intensity is half of the peak value.

GENERAL INFORMATION

- Product series especially designed & optimized for series of LEDs.
- Special care taken to make light distribution as uniform as possible.

Note! Due to use of high power COB's with this product, special attention to proper thermal design is highly recommended. LEDiL has no liability for direct, indirect or consecutive damages arising from the LEDiL products being used outside of the recommended temperature range.