

CLIFF

2.5mm and 3.5mm Mono and Stereo Jack Sockets

The **CLIFF** range of 2.5mm and 3.5mm Jack Sockets are available with unswitched, switched or make contacts and with a choice of solder tag or PCB mounting versions. S6 sockets are produced in accordance with DIN dimensions and are designed for use with our P5/P6 plugs. Many products of Far Eastern origin have Jack Plugs that vary in tip size and we therefore suggest using either our JY series or S6 Special 'C' Contact Jacks, for these particular applications.

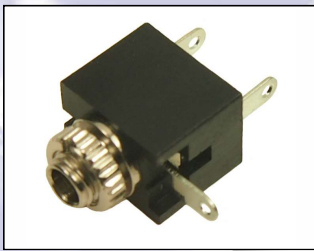

JYO-25 mono switched 2.5mm Jack Socket. Panel mounting with solder tags. Supplied with ring nut.

JYO-25 (FC6810)

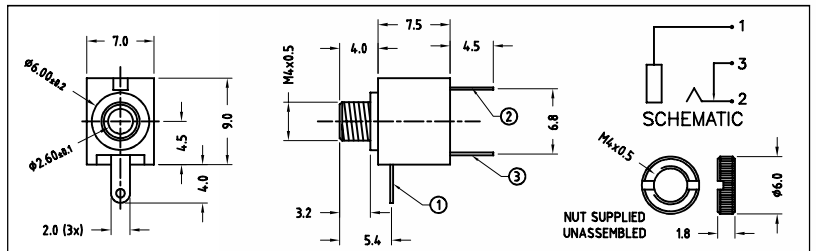

JYO-29 mono 2.5mm Jack Socket. Right Angle PCB mounting.

JYO-29 (FC68102)

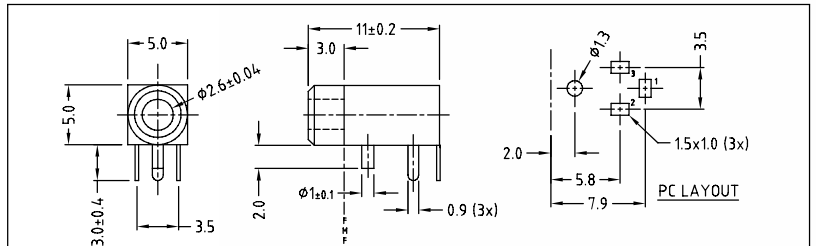

JYO-26 mono switched 2.5mm Jack. Right Angle PCB mounting with ring nut.

JYO-26 (FC6811)

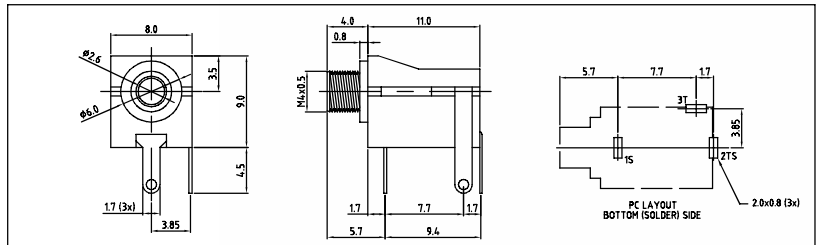

JYO-35 mono switched 3.5mm Jack Socket. Panel mounting with solder tags. Supplied with ring nut.

JYO-35 (FC6812)

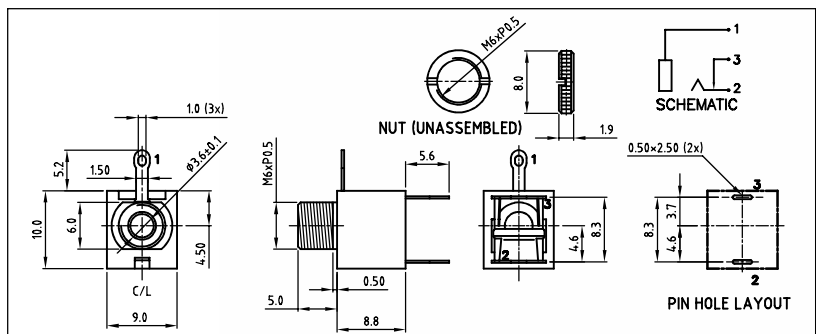

Cliff Electronic Components, Ltd.

76 Holmethorpe Avenue, Holmethorpe Ind. Est.

Redhill, Surrey RH1 2PF. England

Tel: +44 (0) 1737 771375

Fax: +44 (0) 1737 766012

Email: sales@cliffuk.co.uk



Visit us online at:

www.cliffuk.co.uk

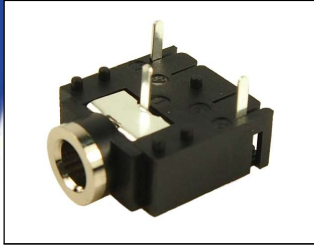

JYO-39-3P stereo unswitched 3.5mm Jack Socket.
JYO-39-5P stereo switched version.
Right angle PCB mounting.
JYO-39-3P (FC68131)
JYO-39-5P (FC68133)

SEE SEPARATE DRAWING



JYS-35 stereo switched 3.5mm Jack Socket.
Right angle PCB mounting.
Supplied with ring nut.
JYS-35 (FT6320)

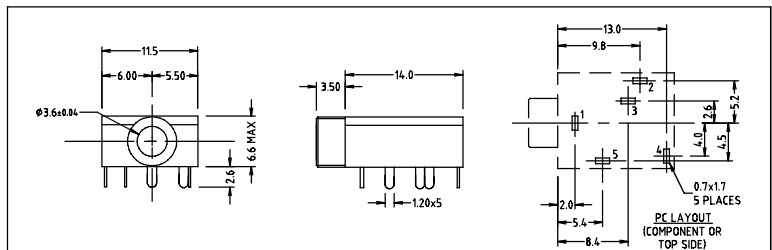

S6/BB mono switched 3.5mm Jack Socket. Panel mounting with solder tags. Also available with Special 'C' Contact to suit Far Eastern plugs.
S6/BB (CL1382)

Supplied with Nickel Plated Hex Nut.

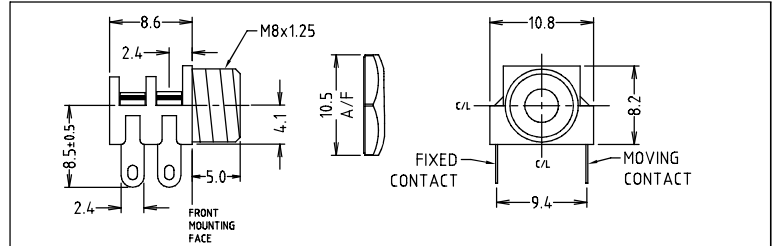

S6/BB PC mono switched 3.5mm Jack Socket. Right angle PCB mounting. Also available with Special 'C' Contact to suit Far Eastern plugs.
S6/BB PC (CL1384)

Supplied with Nickel Plated Hex Nut.

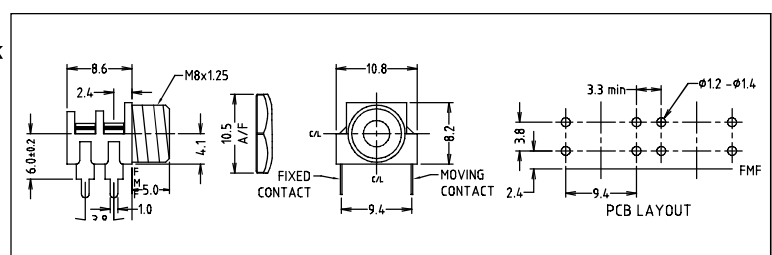

Refer to Sales Office for SMD versions.